



HEWLETT
PACKARD

MEASUREMENT

COMPUTATION

SYSTEMS

1984



HEWLETT PACKARD

AT HEWLETT-PACKARD

Our business is the practical application of high technologies. HP applies its scientific and engineering resources to two fundamental areas: **Measurement** and **Computation**. The company makes more than 4500 products with **broad** application in the fields of science, engineering, business, industry, medicine, and education.

HP has manufacturing facilities in more than 30 cities throughout the world and has sales offices worldwide.

Product Development

Traditionally, HP invests from eight to ten percent of its sales revenue in research and development. The largest share of these dollars support product development programs within HP's manufacturing divisions. This level of commitment enables the company to employ the latest technologies in developing innovative products that can be reliably produced, delivered, and supported on a continuing basis.

Many of the page numbers below refer to the beginning of a catalog section.

GENERAL PURPOSE ELECTRONIC INSTRUMENTS & SYSTEMS

Amplifiers	72	Data Analyzers/	Displays	212
Analog VM's	75	Generators	DMM's/DVM's	82
Board Test Systems	132	Digital Circuits Testers	Electronic Counters	278
Component Testers	98	Digital IC Test Systems	F & T Standards	270

RF & MICROWAVE MEASUREMENT

Amplifiers	72	Microwave Counters	284
Coaxial Test Equipment	392	Microwave Link Analyzers	662
Electronic Counters	278	Microwave Semiconductors	671
Frequency Synthesizers	334	Microwave Test Equipment	392

LOGIC & PROCESSOR-BASED CIRCUIT ANALYSIS

Board Test Systems	132	Digital IC Test Systems	130, 170
Data Generators/Analyzers	169	IC Troubleshooters	141
Digital Circuit Testers	141	Logic Analyzers	153
		Logic Troubleshooting Systems	141

DIGITAL SIGNAL ANALYSIS (FOURIER)

Digital Vibration Control System	525	Plotters	627
Fourier Analyzers	517	Spectrum Analyzers	477, 482

DATA ACQUISITION, CONTROL & TEST

Board Test Systems	132	Data Acquisition, Test &	
Computers, Peripherals		Control Systems	42
& Calculators	582	Digital Multimeters	82

TELECOMMUNICATIONS & DATA COMMUNICATIONS

Amplifiers	72	Frequency Division Multiplexing	550
Analyzers	424	Frequency Synthesizers	333
Cable Maintenance & Testers	549	Microwave Counters	218
Data Communications Testers	568	Microwave Radio Testing	550

HEWLETT-PACKARD INTERFACE BUS (HP-IB) SYSTEM PRODUCTS

Analyzers	469	Data Analyzers/Generators	169
Board Test Systems	132	Data Acquisition, Test & Control	42
Component Testers	98	Digital Voltmeters	82
Computers & Peripherals	582	Electronic Counters	278

COMPUTERS, PERIPHERALS & CALCULATORS

Business Computers	601	Data Acquisition Systems	42
Calculators	584	Digitizers	634
Computers, Peripherals	582	Disc Drives	618, 619, 620
CRT & Data Entry Systems	610	Graphics Display Systems	637

OTHER PRODUCTS

Analytical Instruments		Digital Education Products	652
for Chemistry	672	Dimensional Measurement	644
Cabinet Accessories	658	Frequency & Time Standards	270
CRT Displays	212	Medical Instrumentation	674

Customer Experience

Because HP products are functionally interrelated, the exchange of ideas throughout the company is continuous. A technological achievement in one product area often contributes to improved capabilities in other products and items. Similarly, the wide range of customer needs improves HP's sensitivity and response. HP considers customer comments and suggestions essential to its continuing efforts to improve product quality and usefulness.

Worldwide Support

All HP products come with complete documentation, including instructions for their most effective and efficient operation. Wherever they are sold, worldwide, HP products are supported by customer training programs, by system analyst and customer engineer assistance where required, and by a worldwide network of parts and repair centers for maintenance and service. For more information on HP instrument support, see pages 648 and 678. To locate the HP office nearest you, please see the listing on pages 681-688.

Budgetary Prices

Price information which may be supplied with this catalog provides you with helpful budgetary guidance and are net prices prevailing at time of printing.

Please call your nearby Hewlett-Packard sales office to determine a product's delivered price.

Hewlett-Packard reserves the right to change prices, and those prices prevailing at the time an order received will apply.

Contents overleaf

Function Generators & Frequency Synthesizers 322	Oscillators 305	Pulse Generators 307	Sweep Oscillators 365
PLL 28	Oscilloscopes 180	Recorders & Printers 250	Waveform Recorders 176
	Plotters 627	Signal Analyzers 469	
	Power Supplies 224	Signal Conditioners 262	

Network Analyzers 424	Power Meter 412	Signal Generators 338
Noise Figure Meter 420	RF Impedance Meters 108	Sweep Oscillators 365
Oscilloscopes 180	RF Voltmeter 81	Transceiver Test Equipment 537
Plotters 250, 627	Signal Analyzers 469	Waveguide Test Equipment 392

Microprocessor Development

System 157
Plotters 250, 627
Signature Analyzers 132, 142, 523



Digitizer 634	Graphics Tablet 634	Recorders, Plotters & Printers 250
Electronic Counters 278	Hewlett-Packard Interface Bus 30	Waveform Recorders 176
Frequency & Time Data Acquisition 282	Hewlett-Packard Interface Loop 28	
	Multiprogrammers 65	

Microwave Test Equipment 392	Pulse Code Modulation 540	Telecommunications Test 540
Noise Figure Meter 420	Pulse Generators 307	Transceiver Test Equipment 537
Plotters 250, 627	Signal Generators 338	
Power Meter 412	Sweep Oscillators 365	

Graphics Display System 637	Oscilloscopes 180	Pulse Generators 307
Graphics Tablet 634	Plotters 250, 627	Sources 169, 224, 307, 322, 338, 365
Measurement & Control Processor 56	Power Figure Meter 412	Telecommunications Test 540
Multiprogrammers 65	Power Supplies 225	Waveform Recorders 176

Graphics Tablet 634	Line Printers 624	Recorders & Plotters 250, 627
Hardcopy Terminals 622	Multiprogrammers 65	Tape Drives 617
Hewlett-Packard Interface Bus 30	Portable Computers 588	Technical Computers 602
Hewlett-Packard Interface Loop 28	Printers 622	

Microwave Semiconductors 671	X-Ray Systems 676
Photoelectronic Devices 670	
Pressure & Temperature 646	
Printing & Video Tapes 652	

CONTENTS

ALPHABETICAL INDEX	1
MODEL NUMBER INDEX	12
About Hewlett-Packard.....	24
Instrument Support.....	648
Publications.....	677
Information Request Card.....	back of catalog
Ordering Information.....	680
Sales & Support/Offices.....	681
Post-Sale Support Services.....	678

PRODUCT SECTIONS:

Analytical Instruments for Chemistry.....	672	Medical Instrumentation.....	674
Amplifiers.....	72	Microwave Test Equipment.....	392
Analog Voltmeters.....	75	Network Analyzers.....	424
Cabinet Accessories.....	658	Noise Figure Measurement.....	420
Cables & Adapters.....	656	Oscillators.....	305
Graphics Displays.....	212	Oscilloscopes.....	180
Circuit Test Systems.....	132	Power Figure Meters.....	412
Component Measurement.....	98	Power Supplies.....	224
Computers, Peripherals & Calculators.....	582	Pressure & Temperature.....	646
Data Acquisition, Control & Test.....	42	Pulse Generators.....	307
Data Generators & Data Analyzers.....	169	Recorders, Plotters & Printers.....	250
Data Communications Test Equipment.....	568	Signal Analyzers.....	469
Digital Circuit Testers.....	141	Signal Generators.....	338
Digital Voltmeters.....	82	Sweep Oscillators.....	365
Dimensional Measurement.....	644	Solid State Devices.....	670
Electronic Counters.....	278	Telecommunications Test Equipment.....	540
Function Generators & Frequency Synthesizers.....	322	Training/Video Tapes.....	652
Frequency & Time Standards.....	270	Transceiver Test Equipment.....	537
Hewlett-Packard Interface Bus (HP-IB).....	30	Waveform Recorders.....	176
Hewlett-Packard Interface Loop (HP-IL).....	28	X-Ray, Scientific & Industrial.....	676
Logic Analyzers & Development Systems.....	153		



Identifies products having the Hewlett-Packard Interface Bus (HP-IB) capability. HP-IB is our implementation of the IEEE Standard 488 and the identical ANSI Standard MC1.1, "Digital interface for programmable instrumentation." For the complete story, see pages 30-41.



Identifies products having Hewlett-Packard Interface Loop (HP-IL) capability. HP-IL provides serial loop interfacing for portable, battery-powered systems on the bench or in the field. See page 28.



Identifies newly introduced products or capabilities. New products are also indicated by **boldface** listings in the Model Number Index.

Specifications describe the product's performance. Parameters that are described as **typical**, **nominal**, or **approximately** (\approx) are supplemental characteristics intended to provide information useful to applying the product.



- A**
- AC**
- Digital Voltmeter 82–96
 - Probes 97
 - True RMS Voltmeters 76, 87, 90–92
- Access and Test System 566
- Accessories**
- Cabinet 658–669
 - Cables/Connectors 8, 97, 461, 656
 - Camera 209
 - Connectors, Adapters 463, 657
 - Graphics Software 217, 637
 - Logic Analyzer 167
 - Modular Enclosures (System II) 658–661
 - Network Analyzer 434–437, 445, 453, 461–465
 - Oscilloscope 202
 - PCM/TDM 548
 - Signal Generator 364
 - SLMS 552, 554, 557
 - Spectrum Analyzer 491, 514, 515, 517
 - Transit Cases 664–666
 - Voltmeter 97
- AC to DC Converter 264
- Active Probes 148, 290, 457
- Adapters**
- 50-75 Ω 436, 453, 514, 657
 - Cables/Connectors 656
 - Quasi-Peak 491
- Air Line Extensions 398
- Alphanumeric LED Displays 670
- Alphanumeric Printer 269, 623
- AM/FM Signal Generators 340–352
- AM/FM/ ϕ M Modulation Analyzer 530–533
- AM/FM/ ϕ M Signal Generator 342–347
- AM/FM Test Source 530–533
- Amplifiers**
- Broadband Power 72–74
 - Broadband Preamp 74
 - Distribution 276
 - Plug-Ins for Oscillographic Recorder 262–265
 - Power Supply 245
 - RF/Microwave 72, 73
- Analog Circuit Test System 82–96, 134–138
- Analog-to-Digital Converter 39, 177
- Cards, Multiprogrammer
 - High Speed 67, 69
 - Low Level 67, 69
- Analog Input/Output Cards,
 - HP-1000 A-Series 58
- Analog Voltmeters 76–81
- Analizers**
- Audio 535
 - Audio Spectrum 504
 - Automatic Network 440, 454, 466, 467
 - Automatic Scalar Network 430
 - Automatic Spectrum 477–522
- Baseband 559
 - Correlation 523
 - Data 170
 - Data Line 570
 - Digital Signal 523
 - Digital Transmission 546
 - Distortion 523, 527–529, 535
 - Fourier (FFT) 517, 523
 - Frequency Stability 361, 520, 526
 - Gain-Phase 440, 442, 523
 - Logic 153
 - Low Frequency Spectrum 504, 523
 - Mechanical Impedance 523
 - Microwave Link 562
 - Modal 523
 - Modulation 523, 530–533
 - Network 424–468
 - Phase Noise 361, 526
 - Phase Noise, Side Band 361
 - Primary Multiplex 542
 - Protocol 580, 581
 - RF Impedance 108
 - RF Signal Modulation 530–533
 - Selective Level 554, 571
 - Semiconductor 116, 124
 - Spectrum 477–522
 - Signature 141, 142, 145
 - Software Performance Analyzer 157
 - Structural Dynamics 523
 - Telephone Line 570
 - Transfer Function 523
 - Vibration 515, 523
 - Wave 480, 529
- Applications Manual, Optoelectronics 670
- Applications Support 651
- APC-3.5 series Adapters 463, 657
- APC-7[®] series Adapters 463, 657
- Assembler ROM 595
- Atomic Clock/Frequency Standard 271
- Attenuators**
- 75-Ohm General Purpose 562
 - Coaxial, Fixed 400
 - Coaxial, Microwave, OEM 400
 - Waveguide 399
- Automatic**
- Audio Distortion Analyzer 535
 - Calibration DMM 84, 88, 90
 - Capacitance Bridge 116
 - Computer Aided Test System 65
 - Data Acquisition Systems 42–55, 64
 - Data Logger 45–50
 - LCR Meter 100–103
 - LCZ Meter 104–107
 - Pair Identifier (office unit) 549
 - Test Systems 71, 490

Measurement & Analysis System	64	Power Meter Calibrator for 432 Series	
Network Analyzer	440, 454, 466, 467	Power Meters	418
Scalar Network Analyzer	430	Range Calibrator for 435A Power Meter	415
Selective Level Meter	551, 557	Capacitance Bridges; Meters	116
Synthesizer	334-337, 340-347, 346, 358, 360	Cardiography/Cardiovascular Instrumentation	674
Spectrum Analyzer	477-522	Carrier Preamp	263
Transceiver Test System	537	Carrier Testing	550
		Cases, Combining	662
B		Cavity Frequency Meters	407
Balanced 2/4 Wire Audio Channel Selector	543	Centralized Remote Access and Test System	566
Bar Code Decoder Board	670	Cesium Beam Frequency Standard	271
Bar Code Printer, Dot Matrix	623	Circuit Test Systems	132-141
Bar Code Readers	670	Circuit Testers, Digital	136, 140, 141, 148-151
Bar Code Wand, Digital	670	Clip, Logic	150
Bar Graph Array, LED	670	Clock, Atomic	270
Baseband Analyzer	559	Clock, Digital	39
Baseband Analyzer System Software	560	Clock, Thermal Printer	269
Battery Operated		Coaxial Instrumentation	395
Calculators/Computers	584-588	Accessories	398, 411, 657
Counters	298-301, 304	Adapters	657
DMM	84-95, 304	Air Lines	398
Microwave Power Meter	415, 418	Attenuators	400-403
Beam Lead Diode	671	Crystal Detectors	405, 406
Bit Error Rate Test Set	574-576	Directional Couplers	404
BNC Series Adapters	657	Directional Detectors	405
Board Test, Fixtures	139	Dual Directional Coupler	404
Board Tester, Analog	132-138	Fixed Attenuators	400
Board Tester, Digital	134-138	Filters	290, 410
Breadboard Cards, Multiprogrammer	67, 69	Frequency Meters	407
Bridge, Directional	432	Harmonic Mixer	410
Broadband Amplifiers	72-74	Low-Pass Filters	290, 410
Broadband Phase Comparator	271	Noise Sources	423
Broadband Sampling Voltmeter	81	Pad Attenuators	400
Business Computers	601	Power Sensors	416, 419
		Shorts	409
C		Sliding Load	409
Cabinet Identification	658, 662	Slotted Line Carriage	408
Cable Assemblies	656	Slotted Line	408
Cable Fault Locator	549	Slotted Section	408
Cable Maintenance & Construction	549	Step Attenuators	402
Cables/Connectors	656, 670	Switches	411
Cables, HP-IB	37	Terminations	409
Calculators, Handheld Computers & Peripherals		Thermistor Mounts	419
Card Reader	585	Thermocouple Mounts	416
Cassette Drive	589	Waveguide Adapters	398
Desktop Programmable Printing	584	Comb Generator	514
Enhancement Module	586	Combining Cases	662
Financial Programmable	584	Communications, Series 80	595
Memory Modules	586	Communications Test Equipment	334, 336, 337, 540-569, 571
Optical Wand	585	Communications Test Set	577
Printer/Plotter	585, 589	Comparator, Logic	150
Scientific Programmables	584, 585, 588	Comparator, Phase	271
Calibration Data, Attenuators	401	Component Measurement	98-129
Calibrators		Components	
AM/FM (8901A)	530	Solid State	670, 671



- Component Testers
 - Digital IC Test System 116, 124, 126, 130
 - Digital IC Tester 130
 - Impedance, LCR Meters 100-120
 - Semiconductor Parametric Test 122-128
- Computer-based Spectrum Analyzer 490, 520
- Computers & Peripherals
 - A, E & F-Series Computers 605
 - A-Series Measurement & Control Cards 58
 - Automatic Test Systems 65, 71
 - Business Oriented Computer Systems 601
 - Computer Support 640
 - Disc Drives 620, 621
 - Disc/Tape Drives 621
 - Display Terminals, CRT 610
 - Engineering Workstations 602
 - Flexible Disc Drives 618
 - Graphics Tablets 634-635
 - Handheld Computers 585
 - HP-IL Peripherals 589, 590
 - Interactive Terminals 610
 - MicroWinchester Disc Drives 619
 - Modems 615, 625
 - Modular Computer 602
 - Personal Computers 584-600
 - Plotters 628-633
 - Speech Output Module 609
 - Support 640
 - Tape Drives 617
 - Technical Computers 602-607
 - Thermal Graphics Printers 269
 - Workstation Printers 622, 623
- Conductor Fault Locator 549
- Connector Adapters 657
- Connectors, Microwave Precision 463, 657
- Converters
 - A-to-D 39, 45-55, 58, 67, 69, 84-95
 - D-to-A 38, 48, 52, 56, 58, 67, 69
 - Serial-to-Parallel 38
- Counters, Electronic 278-304
 - Counter/Synchronizer 286
 - Counter/Timer 278-282, 294-304
 - Counter/Tracking Generator 506
 - Digital Multimeter/Counter 142, 304
 - DVM 291, 294-296
 - F&T Data Acquisition System 282
 - HP-IB /HP-IL 302
 - Low Cost 298-304
 - Microwave 283-287
 - Microwave Source, Synchronizer 286
 - Oscilloscope Expansion Module 163
 - Plug-In Adapter 281
 - Portable, Battery Operated 298-301, 304
 - Pulsed RF 283
 - Reciprocal 280, 288, 291, 294, 295, 298
 - Time Interval 280, 288, 291, 294-296, 298, 301, 304
 - Time Interval Probes 290
 - Universal 278-281, 288-304
- Counter/Totalizer Card 67, 69, 183
- Coupler, Acoustic 590
- Couplers, Directional (Coax and Waveguide) 404
- CP/M® System, Series 80 595
- CRT Displays 212, 593
- Crystal Detectors 406
- Crystal Oscillators 275
- Current Probe 97
- Current Tracer, Digital 149
- D**
 - D/A Converter 38, 52-55, 67, 69, 243
 - D/A Converter Cards, Multiprogrammer 67, 69
 - Daisywheel Printer 622
- Data
 - Acquisition Systems 42-56, 64, 282
 - Analyzers 170
 - Communications 568-581, 595
 - Error Analyzer 578
 - Generators 170, 546
 - Line Analyzer 570
 - Logger 45, 50
 - Transmission Test Set 578
- DC
 - Milliammeters 76, 80, 86
 - Voltage Source 122
 - Voltmeters 75-81, 84-95
- DC Power Supplies
 - Amplifier/Power Supply 245
 - Autoranging 234, 240, 242
 - Condensed Listing 225
 - Constant-Current Sources 247
 - Digitally Controlled 244
 - Dual Tracking 229-233
 - General Information 224
 - General Purpose: 10-30 W Output 229
 - General Purpose: 25-200 W Output 232
 - General Purpose: 100-2000 W Output 234
 - General Purpose: 300-11,000 W Output 238
 - High Voltage 248
 - HP-IB Programmable 226, 240-244
 - Microprocessor 234
 - Modular, Single Output, Series Regulated 249
 - Modular, Dual Output, Series Regulated 249
 - Modular, 200-600 W, Switching Regulated 249
 - Modular, 110 W Switching Regulated 249
 - Modular, Triple-Output Switching 249
 - Precision Voltage Sources 246
 - Programmable 224-227, 240, 242, 243
 - Specifications Definitions 228
- Decade Capacitors and Attenuators 121
- Degaussers 268, 271
- Delay Generator 321
- Detectors
 - Adapter 436



- Coaxial, Microwave, OEM 406, 434, 440
 - Crystal, Coaxial and Waveguide 406
 - Error 545-546
 - Slotted Line 408
 - Development Station 157
 - Development Systems, Logic 157
 - Digital
 - AC Voltmeters 76-79, 81, 82-96
 - Analyzer, Logic 153
 - Analyzer, Signature 141-145
 - Board Tester 132-140
 - Cassette Drive 589
 - Circuit Test 132-145
 - Current Tracer 149
 - DC Voltmeters 82-97
 - Education Course 152
 - IC Tester 124-130, 136-138
 - IC Test System 130
 - Impedance Meter 108-112
 - In-Circuit Board Test System 136
 - LCR Meter 100-103, 114-116
 - Microprocessor Troubleshooting 141-145
 - Multimeter 86-95, 141, 142, 582
 - Multimeter, Signature 141, 142
 - Noise Figure Meter 422
 - PC Board Test System 132-140
 - Pressure Gauge 646
 - Programmable Power Supplies 225-227, 240-244
 - Power Meter 413, 414
 - Signal Analyzers 141-145, 469-536
 - Signal Generators 356, 358
 - Signature Analyzer 141-145
 - Spectrum Analyzers 477-522
 - Stimuli 149
 - Test Sets, Digital Logic 141, 146
 - Thermocouple Card, Multiprogrammer 69
 - Thermometer 647
 - to-Analog Current Converter Card 66, 68
 - to-Analog Voltage Converter Card 66, 68
 - Transmission Analyzer 546
 - Troubleshooting 141-145, 148-151
 - Troubleshooting (Video Tape) 652
 - Voltmeters 82-96
 - Digital Electronics
 - Programmable Calculator 579
 - Digital In-Circuit Board Test System 136
 - Digital Input/Analog Comparator Card 67, 69
 - Digital Input/Output Card
 - HP-1000 A-Series 58
 - Digital Input/Output Module 60
 - Digital Input Card, Multiprogrammer
 - Common Ground 67, 69
 - Isolated Input 67, 69
 - Digital-to-Analog Converters 38, 52, 58, 67, 69
 - Digital Output Card, Multiprogrammer 67, 69
 - Digitizing Oscilloscopes 177, 182
 - Diodes 671
 - Directional Bridge 433
 - Disc Drives 620, 621
 - Flexible 618
 - Micro Winchester 619
 - Disc/Tape Drives 621
 - Displays
 - Cathode-ray Tube 212, 593
 - Computer Graphics System 219
 - Display System 218, 638
 - Graphics Generator (HP-IB Interface) 218, 638
 - Imaging 223
 - Instrumentation 220
 - Large Screen 219, 222
 - LED 670
 - Tape Storage Module 179
 - Distortion Analyzers 523, 527, 529, 535
 - Distribution Amplifier 276
 - Double Balanced Mixer 410
 - Doublers, Frequency 362, 534
 - Down Converter (1.7-14.5 GHz to 70/140 MHz) . . . 513, 564
 - Drafting Plotters 632-633
 - Dual Tracking, Power Supply 229, 232
 - Dual VHF Switch Module 60
 - Dynamics Analyzer, Structural 523
- E**
- Eight Channel Bank Amplifiers 265
 - Eight-pen Plotters 630-631
 - Emitters/Detectors 670
 - Optical Reflective Sensor 670
 - Electronic Counters 278-304
 - HP-IB/HP-IL 302
 - EMI Measurement Accessory 491
 - Emulators, Microprocessor 146
 - EPROM Development Kit 602
 - Error Rate Measurements 544-546
 - Exerciser, Microprocessor 146
 - Extenders, HP-IB 40
 - External Mixers 513
- F**
- Faxitron® X-Ray Systems 676
 - FDM/Carrier Systems Testing 550, 557
 - FDM Network Surveillance Software 553, 557, 563
 - Fiber Optics
 - Cable 670
 - Connectors 670
 - Multiplexer 670
 - Transmitters/Receivers 670
 - Filters
 - Coaxial and Waveguide 410
 - High Pass 410, 435
 - Low Pass 290, 435, 500
 - Flexible Disc Drives 618
 - Fourier Analyzer 523



- FM Modulation Analyzer 530
 FM Signal Generators 340–352, 354, 356
 Frame Alignment Monitor & Error Detector 543
 Frequency
 Counters 278–304
 Counter/Tracking Generator 506
 Doublers 362
 Meters, Coaxial and Waveguide 407
 Stability Analyzer 520, 526
 Synthesizer, Microwave 356, 358, 359, 360
 Frequency Reference Card, Multiprogrammer 67, 69
 Frequency Standards 270
 Cesium 271
 Distribution Amplifier 276
 Frequency and Time Standards
 General Information 270
 Quartz 275
 Rubidium 272
 Standby Power Supplies 277
 Frequency and Time Standards 270
 Frequency Selective Meter and
 Tracking Oscillator 336, 337, 480, 554
 Frequency Stability Analyzer 520, 526
 Frequency Synthesizers 334–337, 340–347, 356, 358, 359
 Function Generators 324–327, 334
- G**
- Gas Chromatograph 672
 GC/Mass Spectrometer Systems 672
 General Purpose Interface
 HP-IL 28–29, 586, 594
 General Purpose Integrator Preamp 264
 General Purpose Relay Module 60
 Generators
 Data 546
 Function 322, 324–327, 334
 Graphics 218, 638
 Jitter 547
 Noise 422
 Pattern 544–546
 Pulse 307
 Signal 338–364
 Square Wave 324, 326, 327, 334, 360
 Sweep 327, 334, 336, 337, 365–391
 Timing 39
 Tracking 336, 337, 494, 498, 504, 506, 508, 511
 Graphics
 Generator (HP-IB Interface for displays) 218, 638
 Plotters 628–631
 Printers 622, 623
 Software 635
 Tablets 634
 Terminals 612
 Group Delay (Network Analyzer) 440, 467
 Guarded Digital Multimeter 90, 94
- H**
- Handheld Computers 585
 Hardware Support 678
 Harmonic Mixer (Coaxial and
 Waveguide) 513
 Hewlett-Packard Interface
 Bus (HP-IB) 30–41, 594
 Hewlett-Packard Interface Loop 28–29, 585, 588, 590, 594
 High Gain DC Preamplifier 263
 High Power Attenuators 263, 400
 High Power Sensors 416
 High Resistance Meter 119
 High Speed A/D Converter Card, Multiprogrammer 67, 69
 High Speed System Voltmeter 90, 93
 How to Solder (Video Tape) 655
 How to Use an Oscilloscope (Video Tape) 655
 HP-IB
 Analog-to-digital converter 39, 177
 ASCII-to-parallel converter 38
 Cables 37
 Controlled Attenuator/Switch Driver 403
 Controlled Channel Selector 543
 Digital Clock 39
 Digital-to-Analog Converter 38, 243
 Extenders 40
 Frequency Counters 302
 General Information 30
 Graphics Tablet 634
 Relay Actuator 38, 403
 Switch/Control Unit (HP-IB) 60
 Timing Generator 39
 VHF Switch 38
 HP-IL 28–29, 46, 84, 585, 588–590, 594
 Frequency Counters 302
 Hybrid ROM Development System 595
- I**
- IC Tester, Digital 130
 IC Test System, Digital 130
 IC Testers, Parametric 124–128
 Impact Printer 589, 623
 Impedance Analyzer 108–111
 Impedance Meters 112–124
 Impedance Transformers (50-75 Ω) 514
 In-circuit Functional Tester 132
 Indicators, LED 670
 Industrial Data Acquisition/Control System 56
 Instrument Support 648
 Training Support 649
 Applications Support 651
 Software Support 651
 Hardware Support 678
 Insulation Resistance Meter 90, 119
 Integrators, Reporting 673

Interface Bus (HP-IB)	30
Interface Cards for Computers	594, 602, 603
Interface Loop	28
Interface Kits	
HP-IL	590
Logic Analyzer	167
Multiprogrammer	69
Interfaces, Series 80	594
Interfacing Summary for Computers	608
Interrupt Card, Multiprogrammer	67, 69
J	
Jitter Generator & Receiver	547
K	
Kits, Overhead Transparency	636
Kits, Rack Mounting	658, 659, 662
Kits, Fiber Optic Link	670
L	
Laboratory Automation Systems	673
Laser Measurement Systems	644
Laser Printers	624
LCR Meter	100-103, 114-115
LCZ Meter	104-107
LED Displays	670
LED Indicators	670
Light Bar Modules, LED	670
Light Emitting Diodes	670
Limiter	283, 285, 287, 514
Liquid Chromatographs	673
Log Level Preamp	264
Logic	
Analyzer, Development System	153
Analyzers	153
Analyzer Accessories	167
Clip	150
Current Tracer	149
Comparator	150
Development System	157
Probes	148
Pulser	149
Signal Sources	169, 307
Troubleshooting System	141, 151
Low Distortion Generator	337, 554
Low Distortion Measurement	527
Low Frequency Spectrum Analyzer	504, 523, 524
Low Gain Preamplifier	263
Low Level A/D Converter Card, Multiprogrammer	67, 69
Low Resistance Meter	90, 119
M	
Machinery Analyzer	523
Magnetic Bubble Memory Card	602
Magnetic Tape Recorders, Analog	267
Mass Selective Detectors	672
Mass Spectrometers	672
Matrix Switch (HP-IB)	60
Measurement and Control Cards, HP-1000 A-Series	58
Measurement and Analysis System	64
Measurement and Control System	523
Measuring Receiver	532
Mechanical Impedance Analyzer	523
Medical Instrumentation	674, 675
Memory Card, Multiprogrammer	67
Memory Modules, Series 70	588
Memory Modules, Series 80	593
Meters	
AC	78-81, 84-96
AC Resistance	119
Capacitance	100-117
Conductance	100-117
Digital Multimeter	82-96
Distortion	527, 528
Frequency	407
Impedance	108-112
LCR	100-103, 114-118
LCZ	104-107
Milliammeter, DC	80, 82-95
Milliohmmeter	84-95
Modulation	80-81, 530-533
Multifunction	78-79, 84, 87-95, 119
Noise Figure	422
Ohmmeter	78-79, 84-95
Peak Power	419
Power (RF/Microwave)	413-419
Signature Multimeter	142
Standing-Wave-Ratio (SWR)	408
Susceptance	90, 96
True RMS	76, 87
Vector Impedance	120
Microprocessor Exerciser	146
Microprocessor Power Supplies	230
Microprocessor Training	152
Microprocessor Troubleshooting	141-146, 153
Microwave	
Amplifiers	72, 73
Counters	283-287
Diodes	406, 434, 671
Down-Converter	361
Link Analyzers	562
Network Analyzers	458, 459, 466, 467
Noise Figure Meter	422
Power Measuring Equipment	412-419
Radio Testing	550
Signal Generators	353-363
Source Synchronizer	286
Spectrum Analyzers	482, 487, 494, 500, 510
Sweep Oscillators	365-391
Synthesizers	356-360
Test Equipment	392-406
Transistors	671
Milliohmmeter	78, 82-96

Miniature Fiber Optic Link 670
 Mixers, Double-balanced 410
 Mixers, Coaxial and Waveguide 410, 513
 Modal Analysis 523, 525
 Modems 590, 615, 625
 Modular Spectrum Analyzers 496-512
 Modulation Analyzer 530-533
 Modulator/Demodulator 561
 Modulators, Absorptive 362, 363, 436
 Modulators, PIN 362, 363
 Modulation Test Source 530-533
 Modules (Series 40) 586
 Multi-frequency LCR Meter 100-103
 Multimeter 78, 79, 82-93
 Multimeter, Signature 142
 Multiplex (Primary) Analyzer 542
 Multiprogrammers 62

N
 Network Analysis, General Information 424-429
 Network Analyzers 110, 430-440, 444-468
 Accuracy Enhancement Program for 8409C 467
 Automatic 454, 466, 467
 Automatic Scalar 430
 Scalar 431, 438
 Noise
 Figure Meter 422
 Generator 423
 Measurements 361, 420

O
OEM
 Computers 601, 607
 Displays, CRT 219
 Graphics Plotters 628, 630
 HP-IL Interface Kit 590
 Microwave Attenuators 399
 Microwave Components 399, 403, 411
 Microwave Crystal Detectors 406
 Microwave Switches 411
 Optoelectronic Components 670
 Power Supplies 249
 Strip Chart Recorders 260-261
 X-Y Recorders 256-259
 Ohmmeters 78-79, 84-95
 Open and Split Locator 549
 Operating & Transit Cases 664
 Optical Shaft Encoders 670
 Optional Operational Systems, Series 80 595
 Optocouplers 670
 Optoelectronics 670
 OR Monitors 675
Oscillators
 Audio 306
 Function 306, 324-327, 334
 General Information 305, 322, 323

Low Frequency 334
 Sinewave 306
 Squarewave 306, 324-327, 334
 Sweep 327, 334, 336, 337, 365-391
 Synthesized Sweep 334, 336, 337, 356-360
 Test 306
Oscillographic Recorders 262
Oscilloscopes 180
 Accessories 202
 Camera 209
 Contrast Filters 206
 Digital Waveform Storage 177, 183
 Digitizing 177, 183
 Measurement System 182
 100 MHz Third-channel Trigger View 188
 Delta Time 188
 Fast Variable Persistence Storage 192
 Precision Time Interval 190
 Variable Persistence Storage 193
 200 MHz Delta Time Measurements 196
 275 MHz Delta Time Measurements 196
 275 MHz Delta Time Measurements
 with Microprocessor 196
 275 MHz Fast Variable Persistence Storage 197
 General Information 180
 Inverter Power Supply for 1700
 Series Oscilloscopes 208
 Light Shields 206
 Low Frequency 200
 Plug-In, 180 series 200
 Rack Mount Slides and Adapters 206
 Software, Oscilloscope Measurement System 183
 Spectrum Analyzer Plug-In 496, 498, 500
 Testmobiles 210
 TV/Video Sync Retrofit Kit 207
 Variable Persistence Storage 192
 Viewing Hoods 206
 Outside Plant Cable Test Equipment 549
 Overhead Transparency Kits 636

P
 pA Meter 122
 Pad, Coaxial Attenuator 400
 Page Printers 624
 Patient Monitors 675
 Pattern Generator/Error Detector 544, 545
 PC Board Testers 132-140
 PCM Test Equipment 540-548
 PCM Test Systems 542
 Peak Power Meter, Analog 419
 Peak Power Meter, Digital 419
 Perinatal Instrumentation 674
 Personal Calculators & Handheld Computers 584-591
 Personal Computers 584-600
 Phase Comparator 271
 Phase Meters 291, 442
 Phase Modulation Analyzer 530-533



- Phase Modulation, Signal Generator 342-347
- Phase Noise Measurement 342, 361, 520, 526
- Phase Sensitive Demodulator 264
- PIN Modulators, Microwave 362, 363
- PIN Photodiodes 670
- Plotter Accessories and Supplies 636
- Plotters, Drafting 632-633
- Plotters, Graphics 628-631
- Portable
- Counters 298-304
 - Computers 592
 - Data Logger/Data Acquisition System 46
 - Power Meter 415, 418
 - Spectrum Analyzers 496-501, 515, 529
 - Voltmeter 79, 84-97
 - X-Ray Systems 676
- Power Amplifiers 72-74
- Power Line Conditioner 643
- Power Meter Calibrators 415, 418
- Power Meter/Measuring Receiver 532
- Power Meters, RF & Microwave 413-419
- Power MOS FET 671
- Power Sensors, RF & Microwave 416-419
- Power Splitter 436
- Power Supplies
- Amplifier/Power Supplies 245
 - Atomic Clock 277
 - Condensed Listing 225
 - Constant Current Sources 247
 - Digitally Controlled 226, 240-244
 - Dual Tracking 229-233
 - Frequency Standards 277
 - HP-IB Programmable 226, 240-244
 - Laboratory 224
 - Microprocessor 230
 - Modular, Series Regulated 249
 - Modular/Switching Regulated 249
 - Multiprogrammer Control 62
 - Precision Voltage Sources 246
 - Programmable 226, 240-244
 - Specifications Definitions 228
 - Standby 277
- Power Supply/Amplifier 245
- Practical Transistors (Video Tape) 652
- Preamplifiers 74, 262-265, 290
- Precision Coaxial Connectors 657
- Precision Frequency Source 270
- Precision Oscillator 275
- Preselector 511
- Pressure Gauge, Quartz 646
- Primary Multiplex Analyzer 542
- Primary Multiplex Analyzer Systems 542
- Printer, Graphics 622-624
- Printer, Line 623, 624
- Printer/Printer Terminal 623
- Printers, Letter Quality Daisywheel 622
- Printers, Thermal Graphics 623
- Printer, Thermal Instrumentation 269
- Probes 148
- Accessories 97, 148, 290
 - Active 290, 514
 - Digital Multimeter 97
 - High Frequency 97
 - Logic 148
 - Miniature 202
 - Slotted Line 408
 - Temperature 208, 647
 - Time Interval 290
 - Voltage Divider 97
- Programmable Digitizers 177, 183
- Programmable Modulation Analyzer 530-533
- Programmable ROM Module 595
- Programmable Signal Source 327, 333, 334, 336, 337, 340-347, 356-360, 365-385
- Programming Development Aids, Series 80 595
- PROM Programmer 157
- Protocol Analyzer 580, 581
- Pulse Adder, Splitter, Inverter 320
- Pulse Generators 307
- Accessories 320
- Pulse/Function Generators 307, 322, 327
- Pulsers, Logic 149
- Q**
- Q-Meter 118
- Quartz Frequency Standard 275
- Quasi-Peak Adapter 491
- Quartz Pressure Gauge 646
- Quartz Thermometer 647
- R**
- Rack Mount Kits 658-662
- Rack Slides 658-662
- Range Calibrator (for 435A Power Meter) 415
- Readers, Card 585
- Receiver, Measuring 532
- Recorders
- Oscillographic 262
 - Instrumentation Tape 267
 - Strip Chart 260-261
 - Waveform 177
 - X-Y 256-259
- Reflection/Transmission Test Sets 461, 464
- Reflectometer Bridge 434
- Relay Actuator (HP-IB) 38, 403
- Relay Output Card, Multiprogrammer 67, 69
- Remote Access and Test System 566
- Resistance Meter 78, 82-96
- Retrofit, Signature Analysis 146
- Resuscitation Instrumentation 674
- RF Amplifiers 74
- RF Impedance Analyzer 108
- RF Spectrum Analyzers 480, 484, 496, 498, 506, 508



- RF Test System 537
 RMS Voltmeter 76, 87-95
 ROM's, Series 80 594
 Rotary Air Line, Coaxial 398
 Rotary Joint, Coaxial 398
 Rotary Vane Attenuators, Waveguide 399
 Rubidium Frequency Standard 272
- S**
- S-Parameter Test Sets 460, 462
 Scalar Network Analyzers 430-439
 Scanner Cards, Multiprogrammer 67, 69
 Selective Level Measuring Set 551, 554
 Selective Level Voltmeters 480, 529, 551, 554, 571
 Selective Voltmeter 480, 529, 551, 554, 571
 Self-Test Digital Multimeter 90-92, 94-95
 Semiconductor/Component Test System 126-129
 Semiconductor Parameter Analyzer 124-129
 Sensor Modules 534
 Sensors, Microwave Power 416, 419
 Serial Data Analyzer 579
 Series 10 Professional Calculators 584
 Series 40 Handheld Computers 585
 Series 70 Portable Computers 588
 Series 70 Software 588
 Series 80 Communications 595
 Series 80 Interfaces 594
 Series 80 Optional Operating Systems 595
 Series 80 Personal Computers 592
 Series 80 Programming Development Aids 595
 Series 80 ROM's 594
 Series 80 Software 596
 Shorts, Coaxial 409, 463
 Shorts, Waveguide 409
 Signal Analyzers 469-536
 - Audio 535
 - Automatic Spectrum 477, 490, 517
 - Digital 145, 525
 - Distortion 527, 535, 571
 - General Information 469-476
 - Modular Spectrum 496-512
 - Modulation 530-533
 - Phase Noise 361
 - Spectrum 477-525
 Signal Analyzer, Digital 145
 Signal Conditioners 262-265
 Signal Generators
 - Accessories 364
 - Avionics 351
 - General Information 338
 - HF, VHF, UHF, SHF 340-352
 - Microwave 352-360
 - Programmable 340-347, 360
 - Pulse Modulator 362, 363
 - Synthesized 340-347, 360
 Signal Sources 340-352
 Signal Sources, Programmable 340-347
 Signature Analysis, Troubleshooting System 141
 Signature Analysis 142-146
 Signature Analysis Stimulus 146
 Signature Analyzer, Digital 142-145
 Signature Multimeter, Digital 142
 Single Sideband Phase Noise 361
 Slides for Rack Mounting 658-662
 Sliding Load (Coaxial and Waveguide) 409
 SLMS System Software 553, 557
 Slotted Lines (Coaxial and Waveguide) 408
 SMA, SMB, SMC Series Adapters 657
 Software
 - Applications Solutions 586, 601
 - Business 586, 601
 - Graphics 217, 601, 635
 - Logic State Analyzer 157
 - Oscilloscope Measurement System 183
 - Series 10 584
 - Series 40 586
 - Series 70 588
 - Series 80 596
 - Spectrum Analyzer System 490, 520
 Software Pacs, Transceiver Test 533
 Solid State
 - Displays, Lamps, Arrays 670
 - Diodes, Transistors, Integrated Products,
Power MOS FET's 671
 Software Support 651
 Source, AM/FM Test 347
 Source, Signal 340-352
 Spectrophotometer, Diode Array 673
 Spectrophotometric Detector, Hi Speed 673
 Spectrum Analyzers, General Information 469-476
 Spectrum Analyzers 477-523, 559
 Spectrum Analyzer Preselector 511
 Speech Output Module 609
 Stability Analyzer, Frequency 361, 520, 526
 Standards: Frequency and Time 270
 Standby Power Supply 277
 Standing Wave Ratio (SWR) Meter 408
 Stepping Motor Control 67, 69
 Step Attenuators, Coaxial 402
 Storage-Normalizer 439
 Strip Chart Recorders 260-261
 Structural Dynamics 523
 Sweep Oscillators, General Information 365-367
 Sweep Oscillators 306, 327, 334, 336, 337, 368-391
 Sweep Signal Generator 342-344
 Sweeper Synthesizer 334, 336, 337
 Switch Controller, HP-IB 403, 552
 Switches
 - AC Power Controller 67
 - Access, Distribution and Bi-directional 552
 - Actuators 403

HP-IB Driver 403
 Coaxial, Microwave OEM 411
 Matrix Microwave 411
 Matrix (HP-IB) 60
 5-Port Coaxial 411
 SPDT 411
 VHF Switch, HP-IB 38, 60
 Swivel Adapter 398
 Synchronizer/Counter 286
 Synchronizer, Microwave Source 286
 Synthesized Function Generator 334
 Synthesized Signal Generators 340-347, 356-360
 Synthesized Signal Sources 334, 336, 337, 340-347, 356-360,
 Synthesized Sweep Oscillator 334, 336, 337, 368
 Synthesizer, Time 321
 Synthesizers, Automatic 334, 336, 337, 340-347, 356-360
 Synthesizers, Frequency 334, 336, 337, 340-347
 System, Logic Development 157
 System I, System II Cabinets 658, 662
 System, Digital Diagnostic 141
 System Software, Baseband Analyzer 560
 Systems, Automatic Test 64, 65, 71
 Systems, Modem 625
 Systems, Real Time Computer 605

T
 Tablets, Graphics 634-635
 Tape Degausser 268
 Tape Drives 617
 Tape Recorders, Analog Magnetic 267
 Technical Computers and Peripherals 602-604
 Asynchronous Serial Interface 603
 BCD Input Interface 604
 Breadboard Card 604
 Color Video Interface 602
 Disc Interface 604
 Eight-Channel Multiplex Card 603
 EPROM Development Kit 602
 EPROM Card Datacommunications Interface 602
 Flexible Disc Drives 618
 General Interface 603
 Graphics Tablets 634-635
 HP-IB Interface 602, 603
 HP-IL/Series 80 Interface 594
 Incremental Plotter Interface 604
 I/O Expander 62, 603
 Intelligent Datacomm Interface 604
 Interfacing Summary 608
 Magnetic Bubble Memory Card 602
 Micro Winchester Disc Drives 619
 Multiprogrammer: I/O Expander & Converter 62
 Plotters, Graphics 628-631
 Plotter (Incremental) Interface 604
 Programmable Datacomm Development Package 602

Programmable Datacomm Interface 602
 Real Time Clock Interface 604
 Resource Management Interface 604
 RS-232-C Serial Interface 55, 604
 Serial Interface 604
 Thermal Graphics/Printers 269
 Two Channel DMA Controller Interface 602
 Telecommunications Test Equipment 540-567, 554, 571
 Access Switch 552
 Amplifier, Error Detector Input 548
 Amplifier-IF 562
 Attenuator—75 Ω General Purpose 562
 Audio Channel Selector: HP-IB Controlled 543
 Balanced 2/4-wire Audio Channel Selector 543
 Baseband Analyzer 559
 Baseband Analyzer System Software 560
 Bi-directional Switch 552
 Cable Maintenance and Construction
 Test Equipment 549
 Carrier Testing 550, 554, 571
 Centralized Remote Access and Test System 566
 Controller: Switch 552
 Converter, 75 Ω Unbal/110 Ω Bal 548
 Data Generator 546
 Data Line Analyzers 570
 Detector, Error 545, 546
 Digital Transmission Analyzer 546
 Down Converter 361, 564
 Error Rate Measurements 544-546
 FDM Measurements 550-554, 557
 FDM Surveillance Software 553, 557
 Frame Alignment Monitor & Error Detector 543
 HP-IB Controlled Channel Selector 543
 Isolator, PCM Test Equipment 548
 Jitter Generator & Receiver 477, 547
 Microwave Link Analyzers 562
 Microwave Network Analyzer 458, 459, 466, 467
 Microwave Radio Testing 550
 Modulation Analyzer 530-533
 Modulator/Demodulator 561
 Pattern Generator/Error Detector 544-545
 PCM Terminal Test Set 541
 PCM Test Systems 542
 PCM Testing 540
 Power Meters 412-419
 Primary Multiplex Analyzer 542
 Remote Automatic Surveillance Systems 553
 Selective Level Measuring Set 551, 554, 557
 Selective Level Meter 551, 554, 557
 SLMS Accessories 552
 Spectrum Analyzer 559
 Sweeper, RF 565
 Switch: Access 552
 Switch Controller 403, 552
 Telephone Line Analyzer 570
 Transmission Impairment Measuring Set 574

Voice & Data Testing 568
 White Noise Testing 559
 Temperature Measurement 42, 97, 647
 Termination Panel, Multiprogrammer 69
 Terminations, Coaxial and Waveguide 409
 Test Oscillators 306
 Test Sets, Digital Logic 151
 Test Sets, Signal Generator 533
 Thermal Printers 269, 585, 589, 623
 Thermal Graphics Line Printers 623
 Thermistor Sensors, Coaxial and Waveguide 419
 Thermocouple Power Meters 413, 414
 Thermocouple Power Sensors 416
 Thermocouple Scanning Card, Multiprogrammer 69
 Thermometer, Quartz 647
 Time Base 257
 Time Interval Standard 207
 Time Module, Series 40 586
 Time Standard 270
 Time Synthesizer 321
 Timer/Pacer Card, Multiprogrammer 67, 69
 Timing Generator, HP-IB 39
 Touch-Hold Probe 97
 Tracer, Current 149
 Tracking Generators 336, 337, 494, 498,
 504, 506, 508, 511
 Training/Logic 152
 Train, Microprocessor 152
 Training Support 649
 Training/Video Tapes 652-655
 Transceiver Modulation Analyzer 530-533
 Transceiver Test System 537-539
 Transfer Function Analyzer 517
 Transient Digitizers 177
 Transient Recorders 177
 Transmission Impairment Measuring Set 574-576
 Transmission Test Set 577
 Transistor Bias Supply 463
 Transistor Test Fixtures 460, 462
 Transistors
 Bipolar 671
 GaAs Field Effect 671
 Transit Cases 664-669
 Troubleshooting, Digital 141, 145, 151, 652
 True RMS Voltmeter 76, 87, 90-92, 97
 Tuners, Microwave 410
 Two-Channel Real Time
 Spectrum Analyzer 523-525
 Type N Series Adapters 463, 657
 Type N Short 409, 463

U
 UCSD p-System, Series 80 595
 UHF Signal Generators 342-353
 Ultrasonic Leak Detector 549

Ultrasound Imaging 674
 Understanding Microprocessors (Video Tape) 652
 Upconverter Simulator for Microwave
 Link Analyzer 565

V
 Vector Impedance Meters 112-113, 120
 Vector Network Analyzer 424, 444, 458
 Vector Voltmeter 447
 VHF Generator 348
 VHF Switch Module 60
 Vibration Analyzer 523-525
 Video Interface 590
 Video Tapes 652-655
 Voice/Data Testing 568
 Voltmeters 75-97
 Analog 75-87
 Digital 82-97, 296
 RF 81

W
 Waveform Analyzers 177, 517, 523-525
 Waveform Digitizers 177
 Waveform Recorders 177
 Waveguide 397
 Attenuators 399
 Coaxial Adapters 398
 Crystal Detectors 407
 Directional Couplers 405
 Frequency Meters 407
 Harmonic Mixer 410, 513
 Holder 398
 Low-Pass Filters 410
 Movable Shorts 409
 Reflection/Transmission Test Sets 464
 Shorting Switch 409
 Slide Screw Tuners 410
 Sliding Loads 409
 Sliding Shorts 409
 Slotted Section 408
 Stand 398
 Terminations 409
 Thermistor Mounts 419
 Variable Attenuators 399
 Waveguide-Waveguide Adapters 398
 White Noise Test Set 559
 Wideband Amplifiers 72-74
 Workstation Printers 622, 623

X
 X-Ray Systems, Scientific & Industrial 676
 X-Y Recorders 256-259

MODEL NUMBER INDEX

New product listings are printed in bold face type

HP-10C Programmable Scientific	584
HP-11C Advanced Programmable	584
HP-12C Advanced Financial Programmable	584
HP-15C Advanced Programmable with Matrices	584
HP-16C Advanced Programmable for Digital Electronics and Computer Science	584
HP-41C Handheld Computer	585
HP-41CV Handheld Computer with 5X Memory	585
DTS-70 Digital Test Systems	140
HP-75C Portable Computer	588
HP-85B Personal Computer	592
HP-86B Personal Computer	592
HP-87XM Personal Computer	593
HP-97 Programmable Printing Calculator	584

100

105A/B Quartz Frequency Standards	275
HP 120 Personal Computer	599, 600
HP 125 Personal Computer	599, 600
140T Spectrum Analyzer Mainframe	503
141T System Spectrum Analyzers	502
141T Spectrum Analyzer Mainframe	502
180 series Plug-in Oscilloscopes	200
180C, D High Writing Speed Oscilloscope Mainframes	200
180TR Rack-mount Display Mainframe	496, 498, 500
181AR, Variable Persistence Storage Mainframes	200
181T, TR Variable Persistence/Storage Display Mainframes	496, 498, 500
182T Large Screen Display Mainframe	496, 498, 500
197B Oscilloscope Camera	209

200

200CD Wide Range Oscillator	306
204C Oscillator	306
204D Oscillator	306
209A Oscillator	306
214B Pulse Generator	309
HP 250 Business Computer System	601
281 series Coaxial-Waveguide Adapters	398
292 series Waveguide-Waveguide Adapters	398

300

334A Distortion Analyzer	528
339A Distortion Measuring Set	527
346A/B/C Noise Source	422
355 series Coaxial Step Attenuators	402
360 series Coaxial Low-pass Filters	410
362A series Waveguide Low-pass Filters	410
375 series Waveguide Variable Attenuators	399
382 series Waveguide Precision Variable Attenuators	399
393A Coaxial Variable Attenuator	399
394A Coaxial Variable Attenuator	399

400

400E & EL AC Voltmeters	77
400F & FL AC Voltmeter	77

400 GL AC Voltmeter	77
410C Voltmeter	78
415E SWR Meter	402, 408
420C Coaxial Crystal Detector	406
422A Series Waveguide Crystal Detectors	407
423A/B Coaxial Crystal Detectors	406
424A Series Waveguide Crystal Detectors	407
427A Voltmeter	79
428B Clip-on DC Milliammeter	80
432 Series Power Meters	418
435B Power Meter	415
436A Power Meter	414
436A-E40 Power Sensor Calibration System	417
438A Dual Power Meter	413
442B Slotted Line RF Probe	408
444A Slotted Line Untuned Probe	408
447B Slotted Line Detector Probe	408
478A Coaxial Thermistor Mount	419
486A series Waveguide Thermistor Mounts	419
489A TWT Amplifier	73
491C TWT Amplifier	73
493A TWT Amplifier	73
495A TWT Amplifier	73

500

532 series Waveguide Frequency Meters	407
536A Coaxial Frequency Meter	407
537A Coaxial Frequency Meter	407
545A Logic Probe	148
546A Logic Pulser	149
547A Current Tracer	149
548A Logic Clip	150

600

654A Test Oscillators	306
680 Strip Chart Recorder	260

700

752 series Waveguide Directional Couplers	405
774D Coaxial Dual Directional Coupler	404
775D Coaxial Dual Directional Coupler	404
776D Coaxial Dual Directional Coupler	404
777D Coaxial Dual Directional Coupler	404
778D Coaxial Dual Directional Coupler	404
779D Coaxial Directional Coupler	404
784C Directional Detector	565
786D Coaxial Directional Detector	405
787D Coaxial Directional Detector	405
788C Coaxial Directional Detector	405
789C Coaxial Directional Detector	405
796D Coaxial Directional Coupler	404
797D Coaxial Directional Coupler	404
798C Coaxial Directional Coupler	404

800

809C Slotted Line Carriage	408
810B series Waveguide Slotted Sections	408



816A Coaxial Slotted Section	408
853A Spectrum Analyzer Display	496, 498, 500
870A series Waveguide Slide Screw Tuners	410
895A General Purpose Power Supply	236

900

905A Coaxial Sliding Load	409
907A Coaxial Sliding Load	409
908A Coaxial 50-Ohm Termination	409, 447
909A/C Coaxial 50-Ohm Termination	409
910 series Waveguide Terminations	409
911A/C Coaxial Sliding Loads	409
914 series Waveguide Sliding Loads	407
920 series Waveguide Moving Shorts	407
923A Waveguide Sliding Short	407
930A Waveguide Shorting Switch	407
932A Waveguide Harmonic Mixer	410
934A Coaxial Harmonic Mixer	410
938A Frequency Doubler Set	362
940A Frequency Doubler Set	362

1000

HP 1000 Computers and Systems	605-607
1000/6+ Microsystem	606
1000/26 Computer System	606
1000/27 Computer System	606
1000/29 Computer System	606
1000/60 Computer System	606
1000/65 Computer System	606
1006A Testmobile	210
1007A Testmobile	210
1008A Testmobile	210
1040A Spectrophotometric Detector	673
1051A & 1052A Combining Cases	662
1090 Liquid Chromatograph	672
1110B Current Probe	204
1111A AC Current Amplifier	204
1112A Inverter Power Supply	208
1117B Testmobile, Oscilloscope	210
1120A 500 MHz Active Probe	205
1121A AC Probe	457
1122A Probe Power Supply	204
1124A 100 MHz Active Probe	204
1200B Dual Channel Oscilloscope, 100 μ V/div	201
1201B Dual Channel Storage Oscilloscope, 100 μ V/div	201
1304A 32 cm (13 in.) Display	222
1310B 48.3 cm (19 in.) Display	219
1311B 35.6 cm (14 in.) Display	219
1317B 43.2 cm (17 in.) Display	219
1321B 53.3 cm (21 in.) Display	219
1332A Small Screen Display	223
1335A Small Screen Display	223
1336S Small Screen Display	223
1340A Display Module	222
1345A Digital Display	220
1346A HP-IB Display Module	220
1347A HP-IB Display	220
1351A Graphics Generator	218
1351S Computer Graphics Display System	218

1630A/D Logic Analyzer	163
1640B Serial Data Analyzer	579
1630 A/D + 24D Logic Analysis Measurement Techniques	650
1645A Data Error Analyzer	578
1645S Data Transmission Test Set	578
1700 series Oscilloscopes	188
1715A 200 MHz Δ Time Oscilloscope	196
1722B 275 MHz Δ Time Oscilloscope, with Microprocessor	196
1725A 275 MHz Δ Time Oscilloscope	196
1726A Time Interval Oscilloscope, 275 MHz	190
1727A 275 MHz Oscilloscope	197
1740A 100 MHz Oscilloscope, Third-Channel Trigger View	188
1741A 100 MHz Oscilloscope, Variable Persistence Storage, Third-Channel Trigger View	192
1742A 100 MHz, Time Interval Oscilloscope	188
1743A 100 MHz Crystal Δ Time Oscilloscope, Third Channel Trigger View	190
1744A 100 MHz Oscilloscope, Fast Variable Persistence Storage, Trigger View	193
1745A 100 MHz Oscilloscope, large-screen	188
1746A 100 MHz Oscilloscope, large-screen, Δ time	188
1801A Dual Channel Vertical Amplifier, 50 MHz	200
1805A Dual Channel Vertical Amplifier, 100 MHz	200
1809A Four Channel Vertical Amplifier, 100 MHz	200
1821A Time Base/Delay Generator	201
1825A Time Base and Delay Generator	201
1950A Two Channel Expansion Module	182
1965A Gated Universal Counter Module	183
1980 Oscilloscope Measurement System	182
1980B + 24A Waveform Measurement System Training	649

2000

2106BK Board Computer	607
2107AK Board Computer	607
2113E Computer	607
2117F Computer	607
2137A Computer	607
2139A Computer	607
2156B Computer	607
2178C Model 60 Computer Systems	606
2179C Model 65 Computer Systems	606
2186C/D Model 6+ Microsystem	606
2196C/D Model 26 Computer Systems	606
2197C/D Model 27 Computer Systems	606
2199C/D Model 29 Computer Systems	606
2250 Measurement & Control Processor	56
2382A Office Display Terminal	610
2486A Micro 26 Computer System	606
2487A Micro 27 Computer System	606
2489A Micro 29 Computer System	606
2563A Line Printer	624
2601A Daisywheel Printer	594, 622
2602A Daisywheel Printer	594, 622
2621B Interactive Display Terminal	611
2622A Display Terminal	611
2623A Graphics Terminal	612



2624B Display Terminal	613
2626A Display Station	613
2626W Word Processing Workstation	613
2627A Color Graphics Terminal	612
2635B Printer Terminal	623
2645A Display Station	614
2647F Intelligent Graphics Terminal	614
2648A Graphics Terminal	614
2671A Printer	594, 623
2671G Graphics Printer	594, 623
2673A Intelligent Graphics Printer	594, 623
2680 Laser Printing System	624
2687A Page Printer	624
2688A Page Printer	624
2703 Color Graphics Workstation	615, 616
2804A Quartz Thermometer	647
2813B Quartz Pressure Probe	646
2816A Pressure Signal Processor	646
2932A Impact Printer	594, 623
3000	
HP 3000 Series 39, 42, 48 & 68/Business	
Computer Systems	601
3040A Network Analyzer	440
3046A/B Selective Level Measuring System	557
3047A Spectrum Analyzer System	520
3054A Automatic Data Acquisition/Control	
System	48
3054C Automatic Data Acquisition/Control System	51
3054C + 24D Board Test System User Training	650
3054DL Automatic Data Logger	50
3056DL Data Logger	45
3061A/3062A In-circuit Functional Test System (HP-IB)	134
3065 Board Test Family (HP-IB)	136
HEDS-3200 Digital Bar Code Wand	670
3310A Function Generator	324
3310B Function Generator	324
3311A Function Generator	325
3312A Function Generator	326
3314A Function Generator	327
3325A Function Generator/Frequency	
Synthesizer/Sweeper	334
3335A Frequency Synthesizer	336
3336A/B/C Synthesizer/Level	
Generator	337, 554
3350 series Laboratory Automation Systems	673
3390A Reporting Integrator	673
3400A RMS Voltmeter	75
3403C True RMS Voltmeter	96
3406A Broadband Sampling Voltmeter	81
3421A Data Acquisition/Control Unit	46
3435A Digital Voltmeter	86
3437A High Speed Digital Voltmeter	93
3455A 6½ Digit DMM	94
3456A Systems DVM	90
3466A 4½ Digit Autoranging DMM	87
3468A/B 5½ Digit Multimeter (HP-IL)	84
3478A 5½ Digit Multimeter (HP-IB)	88
3488A Switch Control Unit (HP-IB)	60
3495A Scanner	59
3497A Data Acquisition/Control Unit	52
3529A Magnetometer Probe	80
3551A Transmission Test Set	577
3552A Transmission Test Set	577
3575A Gain/Phase Meter	442
3580A Spectrum Analyzer	515
3581A Wave Analyzer	529
3581C Selective Voltmeter	571
3582A Spectrum Analyzer	517
3585A Spectrum Analyzer	477
3586A/B Selective Level Meter	554
3586C Wave Analyzer	480
3702B IF/BB Receiver (70 MHz IF)	562
3710A IF/BB Transmitter (70 MHz IF)	562
3711A IF/BB Transmitter (70/140 MHz IF)	562
3712A IF/BB Receiver (70/140 MHz IF)	562
3717A 70 MHz Modulator/Demodulator	561
3724A Baseband Analyzer	559
3725A Display	559
3726A Filter Mainframe	559
3730B Down Converter: RF to IF	564
3736B RF Module (1.7 to 4.2 GHz)	564
3737B RF Module (3.7 to 8.5 GHz)	564
3738B RF Module (5.9 to 11.7 GHz)	564
3739B RF Module (10.7 to 14.5 GHz)	564
3743A IF Amplifier	562
3746A Selective Level Measuring Set (32 MHz)	551
3750A Attenuator: 75 Ω	562
3754A Access Switch	552
3755A Switch Controller	552
3756A 90 MHz Bi-directional Switch	552
3757A 8.5 MHz Access Switch	552
3762A Data Generator	546
3763A Error Detector	546
3764A Digital Transmission Analyzer	546
3770B Telephone Line Analyzer	570
3771A Data Line Analyzer (CCITT)	570
3771B Data Line Analyzer (BELL)	570
3776A PCM Terminal Test Set	541
3776B PCM Terminal Test Set	541
3777A HP-IB-controlled Channel Selector	543
3779C Primary Multiplex Analyzer (CEPT)	542
3779D Primary Multiplex Analyzer (Bell)	542
3780A Pattern Generator/Error Detector	544
3781A Pattern Generator (CEPT and	
CCITT Compatible)	545
3781B Pattern Generator (BELL Compatible)	545
3782A Error Detector (CEPT and CCITT Compatible)	545
3782B Error Detector (BELL Compatible)	545
3783A Frame Alignment Monitor & Error Detector	543
3785A Jitter Generator & Receiver (CEPT)	547
3785B Jitter Generator & Receiver (Bell)	547
3964A Instrumentation Tape Recorder	267
3968A Instrumentation Tape Recorder	267
4000	
4061A Semiconductor/Component Test System	126
4062A Semiconductor/Parametric Test System	128
4140B pA Meter/DC Voltage Source	122
4145A Semiconductor Parameter Analyzer	124
4191A RF Impedance Analyzer	108
4192A LF Impedance Analyzer	110



4193A Low Frequency Impedance Analyzer	112
4261A Digital LCR Meter	114
4262A Digital LCR Meter	114
4274A LCR Meter	100
4275A LCR Meter	100
4276A LCZ Meter	104
4277A LCZ Meter	105
4280A 1 MHz C Meter	116
4328A Milliohmmeter	119
4329A High Resistance Meter	119
4342A Q Meter	118
4440B Decade Capacitor	121
4800A Vector Impedance Meter	120
4904A Cable Fault Locator	549
4905A Ultrasonic Leak Detector	549
4910G Open and Split Locator	549
4918A Ultrasonic Leak Detector	549
4925A Bit Error Rate Test Set	574-576
4930A Conductor Fault Locator	549
4935A Transmission Impairment Measuring Set	574-576
4936A Transmission Impairment Measuring Set	574-576
4945A Transmission Impairment Measuring Set	572
4955A Protocol Analyzer	580
4955A + 24A Protocol Analyzer User's Training	650
4960B Automatic Pair Identifier (office unit)	549
5000	
5001A Microprocessor Exerciser (6800)	146
5001B Microprocessor Exerciser (6802, 6808)	146
5001C Microprocessor Exerciser (8085)	146
5001D Microprocessor Exerciser (Z80)	146
5005A Signature Multimeter	142
5005B Signature Multimeter	142
5006A Signature Analyzer	145
5011T Logic Troubleshooting Kit	151
5015T Logic Troubleshooting Kit	151
5021A Logic Troubleshooting Kit	151
5022A Logic Troubleshooting Kit	151
5023A Logic Troubleshooting Kit	151
5024A Logic Troubleshooting Kit	151
5035T Logic Lab	152
5036A Microprocessor Lab	152
5045A Digital IC Tester	130
5046C Digital IC Test System	130
5061A Cesium Beam Frequency Standard	271
5061A with Option 004 Tube	271
E21-5061A Flying Clock (Cesium)	271
5065A Rubidium Frequency Standard	271
E21-5065A Portable Rubidium Time Standard	271
5087A Distribution Amplifier	276
5089A Standby Power Supply	277
5150A Thermal Printer	269
5180A Waveform Recorder	177
5181A Display/Tape Storage Module	180
5300A Counter Mainframe	304
5300B Counter Mainframe	304
5301A 10 MHz Counter Module	304
5302A 50 MHz Universal Counter Module	304
5303B 500 MHz Counter Module	304
5304A Timer/Counter Module	304
5305B 1300 MHz Counter Module	304
5306A Digital Multimeter/Counter	304
5307A Frequency Counter Module	304
5308A Timer Counter Module	304
5310A Battery Pack Module	304
5311B Digital-to-Analog Converter	304
5312A HP-IB Interface Module	304
5314A Universal Counter	301
5315A & 5315B Universal Counters	298
5316A Universal Counter	298
5328A Universal Counter	296
5334A Universal Counter	294
5335A Universal Counter	291
5340A Microwave Frequency Counter	287
5342A Microwave Frequency Counter	284
5343A Microwave Frequency Counter	284
5344S Microwave Source Synchronizer	286
5345A Electronic Counter	280
5355A Automatic Frequency Converter	283
5356A, B, C Frequency Converter Heads	283
5359A Time Synthesizer	321
5363B Time Interval Probes	290
5370B Universal Time Interval Counter	288
5381A Frequency Counter	303
5382A Frequency Counter	303
5383A Frequency Counter	303
5384A Frequency Counter	302
5385A Frequency Counter	302
5390A Frequency Stability Analyzer	526
5391A Frequency and Time Data Acquisition System	282
5420B Digital Signal Analyzer	523
5423A Structural Dynamics Analyzer	523
5427A Digital Vibration Control System	525
5501A Laser Transducer	644
5528A Laser Measurement System	644
5880A Gas Chromatograph	672
5890A Gas Chromatograph	672
5970B Mass Selective Detector	672
5987A GC/Mass Spectrometer	672
5995B GC/Mass Spectrometer	672
6000	
6002A Extended Range DC Power Supply	242
6111A-6116A Precision DC Power Supplies	246
6012A Autoranging Power Supply	234
6024A Autoranging DC Power Supply	234
6034A 200 Watt Autoranging System Power Supply	240
6129C-6131C Digitally Controlled Voltage Sources	244
6140A Digital Current Source	244
6177C Precision DC Current Source	247
6181C Precision DC Current Source	247
6186C Precision DC Current Source	247
6200B-6209B DC Power Supplies	229
6212B-6218B DC Power Supplies	229
6227B Dual Tracking DC Power Supply	232
6228B Dual Tracking DC Power Supply	232
6234A Dual Output Power Supply	229
6235A Triple Output Power Supply	230
6236B Triple Output DC Power Supply	230



New product listings are printed in bold face type

6237B Triple Output DC Power Supply	230
6253A Dual Output DC Power Supply	232
6255A Dual Output DC Power Supply	232
6259B DC Power Supply	236
6260B DC Power Supply	236
6261B DC Power Supply	236
6263B DC Power Supply	236
6264B DC Power Supply	236
6265B DC Power Supply	236
6266B DC Power Supply	236
6267B DC Power Supply	236
6268B DC Power Supply	236
6269B DC Power Supply	236
6271B DC Power Supply	236
6274B DC Power Supply	236
6281A DC Power Supply	232
6282A DC Power Supply	232
6284A DC Power Supply	232
6286A DC Power Supply	232
6289A DC Power Supply	232
6291A DC Power Supply	232
6294A DC Power Supply	232
6296A DC Power Supply	232
6299A DC Power Supply	232
6434B DC Power Supply	238
6438B DC Power Supply	238
6443B DC Power Supply	238
6448B DC Power Supply	238
6453A DC Power Supply	238
6456B DC Power Supply	238
6459A DC Power Supply	238
6464C DC Power Supply	238
6466C DC Power Supply	238
6469C DC Power Supply	238
6472C DC Power Supply	238
6475C DC Power Supply	238
6477C DC Power Supply	238
6479C DC Power Supply	238
6483C DC Power Supply	238
6515A High Voltage DC Power Supply	248
6516A High Voltage DC Power Supply	248
6521A High Voltage DC Power Supply	248
6525A High Voltage Power Supply	248
6824A DC Power Supply/Amplifier	245
6825A DC Power Supply/Amplifier	245
6826A DC Power Supply/Amplifier	245
6827A DC Power Supply/Amplifier	245
6901S Measurement & Analysis System	64
6940B Multiprogrammer	62, 68
6941B Multiprogrammer Extender	62, 68
6942A Multiprogrammer	63
6942A + 24D Multiprogrammer User's Training	649
6942S Computer Aided Test System	65
6943A Multiprogrammer Extender	63
7000	
7010B X-Y Recorder	256
7015B X-Y Recorder	256
7035B X-Y Recorder	257
7044B X-Y Recorder	258-259
7045B X-Y Recorder	258-259
7046B X-Y Recorder	258-259
7130A Strip Chart Recorder, 2 Pen	261
7131A Strip Chart Recorder, 1 Pen	261
7132A Strip Chart Recorder, 2 Pen	261
7133A Strip Chart Recorder, 1 Pen	261
7220T 8-Pen Plotter/Paper Advance	630-631
7221T 8-Pen Plotter/Paper Advance	630-631
7414A 4-Channel Oscillographic Recorder	262
7418A 6 to 8 Channel Oscillographic Recorder	262
7470A 2-Pen Graphics Plotter	594, 628-629
7475A 6-Pen Graphics Plotter	594, 628-629
7580B 8-Pen Drafting Plotter	594, 632-633
7585B 8-Pen Drafting Plotter	594, 632-633
7906 Disc Drive	620
7908 Disc/Tape Drive	621
7911 Disc/Tape Drive	621
7912 Disc/Tape Drive	621
7914 Disc/Tape Drive	621
7920 Disc Drive	620
7925 Disc Drive	620
7933 Disc Drive	621
7935 Disc Drive	621
7970B/E 1/2" Magnetic Tape Subsystem	617
7971A 1/2" Tape Drive	617
7974A 1/2" Magnetic Tape Subsystem	617
7976A Magnetic Tape Subsystem	617
8000	
8005B Pulse Generator	315
8007B Pulse Generator	318
8011A Pulse Generator	315
8012B Pulse Generator	316
8013B Pulse Generator	316
8015A Pulse Generator	317
8016A Word Generator	173
8018A Serial Data Generator	175
8080A Mainframe	320
8081A Repetition Rate Generator, 300 MHz	320
8082A Pulse Generator	319
8083A Output Amplifier, 300 MHz	320
8084A Word Generator, 300 MHz	320
8091A Repetition Rate Generator, 1 GHz	320
8092A Delay Generator/Freq. Divider	320
8093A Output Amplifier, 1 GHz	320
8111A 1 Hz-20 MHz Pulse/Function Generator	330
8112A Programmable Pulse Generator	310
8116A Pulse/Function Generator	331
8160A Programmable Pulse Generator	312
8161A Programmable Pulse Generator	312
8165A Programmable Signal Source	333
8170A Logic Pattern Generator	174
8180A Data Generator	170
8181A Data Generator Extender	170
8182A Data Analyzer	170
8340A Synthesized Sweeper	360, 368-370

8349A Broadband Solid-state Amplifier 73
8350B Sweep Oscillator Mainframe 372-375, 565
8403A Modulator 363
8404A Leveling Amplifier 371
8405A Vector Voltmeter 447
8406A Comb Generator 514
8407A Network Analyzer 456
8408B Network Analyzer Subsystem 466
8408S Automatic Network Analyzer System 466
8409C Network Analyzer Subsystem 467
8409C + 24D Automatic Network Analyzer User's Course 650
8409S Automatic Network Analyzer System 467
8410C Network Analyzer Mainframe 458
8410S series Network Analyzers 465
8411A Harmonic Frequency Converter 459
8412B Phase-Magnitude Display 456, 459
8413A Phase Gain Indicator 465
8414B Polar Display 456, 459
8418B Auxiliary Power Supply 459
8443A Tracking Generator-Counter 506
8444A Tracking Generator 508
8444A Option 059 Tracking Generator 492, 494, 498, 511
8445B Automatic Preselector 511
8447 series Amplifiers 74
8450A Diode Array/Spectrophotometer 673
8451A Diode Array Spectrophotometer 673
8470A/B Coaxial Crystal Detectors 406
8471A Coaxial Crystal Detector 406
8472A Coaxial Crystal Detector 406
8473B/C Coaxial Crystal Detectors 406
8477A Power Meter Calibrator 418
8478B Coaxial Thermistor Mount 419
8481A/B/H Power Sensors 416
8482A/B/H Power Sensors 416
8483A Power Sensor 416
8484A Power Sensor 416
8485A Power Sensor 416
8491A/B Coaxial Fixed Attenuators 400
8492A Coaxial Fixed Attenuator 400
8493A/B/C series Coaxial Fixed Attenuators 400
8494A/B/G/H series Coaxial Step Attenuators 400
8495A/B/D/G/H/K series Coaxial Step Attenuators 402
8496A/B/G/H series Coaxial Step Attenuators 402
8497K Coaxial Step Attenuator 402
8498A Coaxial Fixed Attenuator 402
8501A Storage-Normalizer 451
8502A & B Reflection Transmission Bridges 445, 452
8503A & B S-Parameter Test Sets 452
8505A Network Analyzer 448
8507D Network Analyzer Subsystem 454
8507S Automatic Network Analyzer System 454
8552A Spectrum Analyzer—IF Section 502
8552B Spectrum Analyzer—IF Section 502
8553B Spectrum Analyzer, Tuning Section 506
8554B Spectrum Analyzer, Tuning Section 508
8555A Spectrum Analyzer, Tuning Section 510

8556A Spectrum Analyzer, Tuning Section 504
8557A Spectrum Analyzer 496
8558B Spectrum Analyzer 498
8559A Spectrum Analyzer 500
8565A Spectrum Analyzer 494
8566A Spectrum Analyzer 482, 487
8566A + 24D Spectrum Analyzer Programming 649
8566S Automatic Spectrum Analyzer 490
8568A Spectrum Analyzer 482, 484
8568A + 24D Spectrum Analyzer Programming 649
8568S Automatic Spectrum Analyzer 490
8569B Spectrum Analyzer 492
8569B Option E30 External Mixer Kit 492
8600A Digital Marker 371, 457
8601A Generator/Sweeper 371, 457
8614A Signal Generator 353
8616A Signal Generator 353
8620C Sweep Oscillator 385-391, 565
8640A,B AM/FM Signal Generators 348
8640B Option 004, Avionics Signal Generator 351
8654A Signal Generator 352
8654B Signal Generator 352
8656A Signal Generator 340
8660A Synthesized Signal Generator 345
8660C Synthesized Signal Generator 345
8662A Synthesized Signal Generator 342
8663A Synthesized Signal Generator 342
8671A Microwave Frequency Synthesizer 359
8672A Synthesized Signal Generator 356
8672S MW Synthesized Generator (0.1 to 18 GHz) 359
8673B Synthesized Generator (2 to 26.5 GHz) 356
8673C/D Synthesized Signal Generator (0.1 to 18/26 GHz) 358
8683A/B Signal Generators 354
8684A/B Signal Generators 354
8709A/B Phase-lock Synchronizer 465
8717B Transistor Bias Supply 463
8721A Coaxial Directional Bridge 457
8731-8735 series PIN Modulators 363
8743B Reflection/Transmission Test Unit 461
8745A S-Parameter Test Set 460
8746B S-Parameter Test Set 462
8747A/B Waveguide series Reflection/Transmission Test Units 464
8748A S-Parameter Test Set 445
8750A Storage-Normalizer 456, 468
8754A Network Analyzer 444-446
8755C Scalar Network Analyzer Plug-in 439
8755S Scalar Network Analyzer 438
8756A Scalar Network Analyzer 431, 432
8756S Automatic Scalar Network Analyzer System 430-437
8761A & B Coaxial Switches 411
8801A Low Gain Preamplifier 263
8802A Medium Gain Preamplifier 263
8803A High Gain Preamplifier 263
8805A Carrier Preamplifier 263
8805B Carrier Preamplifier 263
8806B Phase Sensitive Demodulator 264
8807A AC/DC Converter 264



MODEL NUMBER INDEX

New product listings are printed in bold face type

8808A Logarithmic Preamplifier	264
8809A Signal Coupler	264
8815A General Purpose Integrator	264
8820A DC Bank Amplifier	265
8821A DC Bank Amplifier	265
8900C/D Peak Power Meter	419
8901A Modulation Analyzer	530
8901B Modulation Analyzer	530
8902A Measuring Receiver	532, 534
8903A Audio Analyzer	535
8952A Signal Generator Test Set	533
8953A Transceiver Test Set	538
8954A Transceiver Interface	538, 539
8955A R.F. Test System	537
8956A System Interface	537, 539
8970A Noise Figure Meter	422
9000	
HP 9000 Engineering Workstation	603
9020B/C/S/T HP 9000 Model 20 Computer	603
9030A HP 9000 Model 30 Computer	603
9040A/S/HP 9000 Model 40 Computer	603
9111A Graphics Tablet	594, 634
9121D/S 3.5 in.—Flexible Disc Drive	593, 618
9133V Winchester/3½" Micro Floppy	619
9133XV Winchester/3½" Micro Floppy	619
9134XV 14.5 MByte Winchester	619
9411B Switch Controller	71
9412A Modular Switch	71
9413A VHF Switch	71
9414A Matrix Switch	71
9816A/S Technical Computer	602
9826 Computer System	602
9836A Desktop Computer	602
9845B, C, T Desktop Computer	602
9872T 8-Pen Plotter/Paper Advance	594, 630-631
9876A Thermal Graphics Line Printer	623
9885M/S Flexible Disc Drive (8")	618
9888A Bus Expander	604
9895A Flexible Disc Drive (8")	618
9920A Modular Computer	602
10000	
10001A 10:1 Divider Probe	203
10001B 10:1 Divider Probe	203
10002A 50:1 Divider Probe	203
10002B 50:1 Divider Probe	203
10003A 10:1 Divider Probe	203
10004D 10:1 Divider Probe	203
10005D 10:1 Divider Probe	203
10006D 10:1 Divider Probe	203
10007B 1:1 Probe	203
10008B 1:1 Probe	203
10011B BNC Adapter Tip	206
10013A 10:1 Divider Probe	203
10014A 10:1 Divider Probe	203
10016B 10:1 Divider Probe	203
10017A Miniature Divider Probe	202
10018A Miniature Divider Probe	202
10019A Cable Assembly	205
10020A Resistance Divider Probe	203
10021A Miniature 1:1 Probe	202
10022A Miniature 1:1 Probe	202
10023A Temperature Probe	97, 208
10024A IC Test Clip	206
10026A Miniature 1:1 Probe (50 Ω)	202
10027A Miniature 1:1 Probe (50 Ω)	202
10028A Jumper Cable	206
10029A TV/Video Sync Retrofit Kit	207
10034A Probe Ground Lead Kit	205
10035A Probe Tip Kit	205
10036B Probe Tip Kit	205
10037B Probe Tip Kit	205
10040A 10:1 Miniature Divider Probe	202
10041A 10:1 Miniature Divider Probe	202
10042A 10:1 Miniature Divider Probe	202
10080A Miniature 10:1 Probe	202
10081A Miniature 10:1 Probe	202
10082A Miniature 10:1 Probe	202
10083A Miniature 1:1 Probe	202
10084A Miniature 1:1 Probe	202
10100C 50 ohm Feedthrough Termination	206
10100B 100 ohm Feedthrough Termination	206
10110B BNC Male to Dual Banana Plug	657
10111A Shielded Banana Plug to BNC Female	657
10113A Triple Banana Plug to Dual BNC Female	657
10116A Light Shield for 1220 Series Oscilloscopes	206
10140A Viewing Hood for 1700 Series Oscilloscopes	206
10166A Front Panel Cover (180A, 181A, 184A)	206
10173A RFI Filter and Contrast Screen for 1700 Series Oscilloscopes	206
10176A Viewing Hood for 12.7 cm (5 in.) Rect. CRT	206
10178A Metal Mesh Contrast Screen for 181 and 184 series Oscilloscopes	206
10221A 50 Ohm Probing Tee	205
10229A Retractable Hook Tip Adapter	206
10235A Interface Cover for 1645A	578
10269A Probe Interface (1630A/D)	167
10275A PDP-11 UNIBUS Interface	168
10276A LSI-11 Interface	168
10326A Time Interval Standard	207
10387A Interface, Type 303 Modems (1645A)	578
10388A Interface, CCITT V35 (1645A)	578
10389A Interface, Breakout Box (RS-232C) (1645A)	578
10407B Plug-in Extender (180 system)	206
10475A 3 in. Drawer for 1117B	211
10476A 8 in. Drawer for 1117B	211
10501A Cable Assembly	656
10502A Cable Assembly	656
10503A Cable Assembly	656
10514A Double-balanced Mixer	410
10525T & 10525E Logic Probes	148
10526T Logic Pulser	149
10529A Logic Comparator	150



10533A BCD Interface Cable (5150A, 5300A)	269
10534A Double-balanced Mixer	410
10541A Reference Boards	150
10541B Preprogrammed Reference Boards	150
10590A Plug-in Adapter (5345A)	281
10595A Board Extender Kit (5345A)	281
10638A Degausser	274
10656A 5035A/T Texts & Lab Workbooks	152
10657A 5035A/T Component & Wire Kit	152
10833 A/B/C/D HP-IB Cables	37, 269
10834A HP-IB Cable Adapter	37
10842A Extender Board Kit (5342/5343/5344S)	285
10844B Programming Interface Kit (5045A)	131
10845A Program Card (5045A)	131
10846A Program Card Coupon Book	131
10847A 5045A Service Kit	131
10855A Broadband Preamplifier (5363B)	290, 297
10856A Low Pass Filter Kit (5363B)	290, 297
10870A Service Kit	288
10871A Service Kit	179
10872A Parallel Interface	179
10873A Rack Mount Kit	179
10874A Slide Mount Kit	179
11000	
11000A Cable Assembly	656
11001A Cable Assembly	656
11002A Test Leads	656
11003A Test Leads	656
11035A Cable Assembly	656
11036A AC Probe for 410C	78
11075A & 11076A Instrument Cases	663
11096B High Frequency Probe	97
11143A Cable Assembly	656
11170A/B/C Cable Assembly	656
11500A/B Cable Assembly	656
11501A Cable Assembly	656
11509A Fuseholder	364
11511A Coaxial Short	409
11512A Coaxial Short	409, 447
11515A Waveguide Adapter	398
11516A Waveguide Adapter	398
11517A Mixer	513
11518A-11520A Waveguide Taper Sections	513
11524A APC-7 to N (female) Adapter	657
11525A APC-7 to N (male) Adapter	657
11533A APC-7 to SMA (male) Adapter	657
11534A APC-7 to SMA (female) Adapter	657
11536A Probe Tee for 8405A	447
11540A Waveguide Stand	398
11545A-11548A Waveguide Holders	398, 447
11549A Power Splitter for 8405A	447
11565A Coaxial Short	409
11566A Air Line Extension	398
11567A Air Line Extension	398
11570A Accessory Kit for 8405A	447
11581A Attenuator Set	400
11582A Attenuator Set	400
11583A Attenuator Set	400
11588A Swivel Adapter	398
11589A & 11590A Bias Networks	463
11599A Quick-Connect Adapter for 8745A	464
11600B Transistor Fixture	460
11602B Transistor Fixture	460
11604A Universal Extension for 8745A	460
11605A Flexible Arm for 8743A	464
11606A Rotary Air Line	398
11607A Small Signal Adapter for 8745A	464
11608A Transistor Fixture	462
11609A Cable Kit for 8410S	463
11610B Test Port Extension Cable	461
11650A Accessory Kit for 8410S	463
11652A Reflection/Transmission Kit for 8407A	457
11664A/B Detector for 8755 and 8756	434
11664C Detector Adapter for 8755 and 8756	436
11665B Modulator for 8755 and 8756	436
11666A Reflectometer Bridge for 8755 and 8756	434
11667A dc-18 GHz Power Splitter	436
11668A 50 MHz High Pass Filter for 8755 and 8756	435
11672A Service Accessory Kit for 8660A/C	345
11675B Leveling Cable Assembly for 784C	565
11678A Low Pass Filter Kit	435
11679A/B Extension Cables for 8755 and 8756	436
11683A Range Calibrator	415
11684/5/6/8/9A Low Pass Filters	435
11687A Adapter, 50 to 75 Ω	364
11690A Frequency Doubler	364
11691D Coaxial Directional Coupler	404
11692D Coaxial Dual Directional Coupler	404
11693A Limiter	514
11694A Matching Transformer, 50-75 Ω	514
11697A/B/C Bandpass Filters	364
11708A Attenuator (for Calibrating 8484A)	417
11710B Down Converter	364
11712A Service Support Kit (for 8671A, 8672A/S)	356, 359
11713A Attenuator/Switch Driver	403
11714A Service Support Kit (for 8662A, 8663A)	342
11715A AM/FM Test Source	534
11716A, B Interconnection Kits	403
11717A Attenuator/Switch Rack Mount Kit	403
11720A Pulse Modulator	362
11721A Frequency Doubler	364, 536
11722A Sensor Module	534
11723B Software Application Pac for 8953A & 85F	538
11724A Software Package Pac for 8955A & 9835A	537
11725A Software Package Pac for 8955A & 9845A	537
11726A Support Kit for 8673B/C/D	356, 358
11729B Carrier Noise Test Set	361
11731A Frequency Extension Retrofit Kit	359
11732A Frequency Extension Retrofit Kit	359
11790A/B Software Application Pac for 8953A & 9826/36A	538
11791A Software for 8955A, 9816S & 9836S	537
11850A & B Power Splitters	445, 452
11851A RF Cable Kit for 8505A	445, 453
11852A 50-75 Ω Minimum Loss Pad	453
11853A 50 Ω Type N Accessory Kit	453
11854A 50 Ω BNC Accessory Kit	453

MODEL NUMBER INDEX

New product listings are printed in bold face type

11855A 75 Ω Type N Accessory Kit	453
11856A 75 Ω BNC Accessory Kit	453
11857A/B Test Port Extension Cables for 8503A & B	447, 453
11858A Rigid Interconnect Adapter	453
11863E/F Accuracy Enhancement Program for the 8409C	467
11866A APC-7 Calibration Kit	463
11867A RF Limiter	514
11869A Adapter for 86200 Series Sweeper Plug-ins	384, 390
11870A Low Pass Filter	500
11873A Accuracy Enhancement Program (for 8408B)	466
11970 Series Harmonic Mixers	513
11971 Series Harmonic Mixers	513
11975A Microwave Power Amplifier	72
12000	
12060 8 Channel Input Card	58
12061 32 Channel Analog Input Expansion Card	58
12062 4 Channel Analog Output Card	58
12063 32 Channel Digital Multifunction Card	58
12103A-D Memory Cards, 128 kb to 1 Mb	607
12104A Error Correcting Memory, 512 kb	607
12153A Writable Control Store Card	607
12156A Floating Point Processor	607
12157A Battery Backup System	607
13000	
13064A Tape Degausser	268
14000	
14513A Rack Kit (for one unit, 3½ in. H)	231
14515A Rack Kit (for one unit, 5¼ in. H)	233
14521B Rack Kit (for Bench Series)	231
14523A Rack Kit (for two units, 3½ in. H)	231
14525A Rack Kit (for two units, 5¼ in. H)	233
14533B Pocket Programmer	244
14534A Pocket Programmer Cable	244
14535A Interface Kit, DCPS-to-HP 1000 Computers	244
14536A DCPS Chaining Cable	244
14539A Cable Assembly, DCPS to HP 1000 Computers	244
14540A 1000 Cable Assembly, Multiprogrammer-to HP 1000 Computers	69
14541A Chaining Cable, 6940B or 6941B to 6941B	69
14550B Interface Kit, Multiprogrammer-to- HP 1000 Computers	69
14551A Multiprogrammer Service Kit	69
14558A Termination Panel	69
14750A Computer Aided Test Programming Package	65
15000	
15104A Pulse Adder/Splitter	320
15115A Pulse Splitter/Inverter	320
15116A Pulse Inverter	320
15179A Rack Adapter Frame	316
15406A-15423A 8180A/82A Accessories	172
15413A Tristate Pod for 8180A/81A	172

15414A Tristate Unit for 8180A/81A	172
15452A-15458A 8170A Accessories	174
15506A Frame Alignment Generator	548
15507A Isolator	548
15508B Impedance Converter	548
15508C Converter (75 Ω Unbal. - 120 Ω Bal.)	548
15509A/B Amplifier	548
15510A 75 Ω Cable Accessory	548
15511A 120 Ω Cable Accessory	548
15512A Cable	548
15513A Cable	548
15514A Transit Case	548
15515B Loop Holding Unit	548
15580A 20 MHz High-Impedance Active Probe	552
15581B 25 MHz High-Impedance Passive Probe	552
15582A Return Loss Kit	552
15589A Instrument Cart	552
15600A Isolator (3.7 to 4.2 GHz)	564
15601A Isolator (5.9 to 6.5 GHz)	564
15602A Isolator (7.1 to 8.1 GHz)	564
15603A Isolator (10.7 to 11.7 GHz)	564
15609A Remote Extender Cable	564
16000	
16008A Resistivity Cell	119
16014A Series Loss Test Adapter	118
16023B dc Bias Controller	103
16034B Test Fixture for chip components	103
16047B Test Fixture with Safety Cover	103
16047C Test Fixture for high frequencies	103
16048A Test leads, BNC	103
16048B Test leads, RF miniature	103
16048C Test leads with Alligator Clips	103
16048D Test leads, BNC (2m)	107
16061A Test Fixture	115
16062A Test Cables	115
16063A Test Cables	115
16064A Retrofit Kit	107
16065A External DC Bias Test Fixture	107
16081A Test Leads	117
16082A Test Leads	117
16091A Coaxial Fixture Set	109
16092A Spring Clip Fixture	109
16093A Binding Post Fixture	109
16093B Binding Post Fixture	109
16094A Probe Fixture	103
16095A Probe Fixture	111
16096A 2-port Component Test Fixture	111
16097A Accessory Kit	111
16099A Test Fixture Adapter	113
16380A Decade Capacitors	121
16470A/B/C Reference Inductors	118
16800A Programmable Bar Code Reader	670
16801A Non-Programmable Bar Code Reader	670
17000	
17108A Time Base	257
17580A HP-ISPP Software	635
17623A Graphics Tablet	634-635



18000			
18021A Contact Probe (for Ultrasonic Detectors)	549	34111A High Voltage Probe	97
18043A Ultrasonic Reflector	549	34112A Touch-Hold Probe	97
18107A External Oscillator (2804A)	647	34118A Test Lead Kit	97
18108A Line Amplifier (2804A)	647	35030A Power Line Conditioner	643
18110A Laboratory Probe and Cal Module, 26 mm (1 in.) (2804A)	647	37014B FDM Measurement Software	553
18111A Laboratory Probe and Cal Module, 232 mm (9.1 in.) (2804A)	647	37016A FDM Network Surveillance Software	553
18112A Laboratory Probe and Cal Module, 486 mm (19.1 in.) (2804A)	647	37018A/B Baseband Analyzer System Software	560
18115A Heavy Duty Probe and Cal Module, 29 mm (1.1 in.) (2804A)	647	37050S FDM Network Monitoring System	553
18116A Heavy Duty Probe and Cal Module, 129 mm (5.1 in.) (2804A)	647	37051S FDM Measurement System	553
18117A Heavy Duty Probe and Cal Module, 179 mm (7.1 in.) (2804A)	648	37100S Centralized Remote Access and Test System	566
		37201A HP-IB Extender	40
19000		37203A HP-IB Extender	41
19800A/B Waveform Measurement Library	183	37203L HP-IB Extender (Plug-In Card)	41
19081A/B/C Waveform Measurement Library	183	37212A Stand Alone Modem	625
19807A Service Extender for 1980 Expansion Modules	187	37213A Modem Card	625
19811A Plot/Sequence ROM	187	37214A Modem Interface Card Cage	625
19860A Digital Waveform Storage	183	37215A Modem Interface Card	625
		37216A Terminal Interface Card	625
20000		37222A Integral Modem	625
25501B 16 Channel High Speed Analog Input Card	57	37230A Short Haul Modem	626
25502B 32 Channel High Level Multiplexer Card	57	37264A Band Defining Filter (for 3726A)	559
25503B 32 Channel Low Level Multiplexer Card	57	37265A Band Stop Filter (for 3726A)	559
25503C 32 Channel Low Level Multiplexer with Thermocouple Reference Connector	57	37266A Band Pass Filter (for 3726A)	559
25504B 16 Channel Relay Multiplexer Card	57	37267A Adapter Case (for 3726A)	559
25504C 16 Channel Relay Multiplexer with Thermocouple Reference Connector	57	37268A Dummy Plug-in (for 3726A)	559
25510B 8 Channel Isolated Voltage/Current Analog Output Card	57	37269A Front Panel Input Connector (for 3726A)	559
25511B 32 Channel Digital Input Card	57	37461A Display	551
25512B 4 Channel Counter Card	57	39301A Fiber Optic Multiplexer	670
25513B 32 Channel Digital Output Card	57		
25515B 4 Channel Pulse Output Card	57	40000	
25516B 16 Point In/16 Point Out Digital Multifunction Card	57	43700 Flash X-Ray Systems	676
27110A HP-IB Interface	603	43855A Cabinet X-Ray Systems	676
27112A General-purpose Interface	603	44401A 10 Channel Low Thermal Relay Assembly	59
27116A HP-CIO Extender Card	604	44402A 10 Channel Relay Actuator Assembly	59
27128A Asynchronous Serial Interface	603	44403A 9 Channel Reference Assembly With Thermocouple Compensation	59
27130A Eight-Channel Multiplex Card	603	44404A 20 Channel Low Thermal Relay Assembly	59
27201A Speech Output Module	609	44405A 19 Channel Reference Assembly With Thermocouple Compensation	59
		44413A High Speed Control Board	59
30000		44462A 10 Channel Multiplexer Assembly	47
33300 series Coaxial Step Attenuators	399	44463A Extra Connector Block	47
33311B/C Coaxial Switches	411	44464A Breadboard Assembly	47
33311B-C04 Microwave Matrix Switch	411	44465A 8-bit in, 8-bit out Digital I/O Assembly	47
33311B-C05 5-Port Switch	411	44466A Extra Connector Block for 44465A	47
33320 series Coaxial Step Attenuators	399	44468A Data Acquisition Pac for 41CV	47
33330B, C Coaxial Crystal Detectors	406	44469A Six 10:1 Dividers	47
33340A/B/C Coaxial Attenuator	403	44538A Small Test Fixture	139
34110A Carrying Case	97	44539A Large Test Fixture	139
		44540A Dial Test Fixture	139
		44854 + 24A 3060A Enhancement Training	650
		50000	
		50011A HP-IB Instrument System Training with Model 26 Controllers	649
		50600B Instrument Application Services	651
		52126A Intel Multibus Interface	168
		55005S Logic Troubleshooting System	141

MODEL NUMBER INDEX

New product listings are printed in bold face type

55280A/55283A + 24A Laser Measurement System Training	650	69501A-69513A Power Supply Control Cards	69
59301A ASCII-Parallel Converter	38	69520A Power Supply Programming Card	69
59303A Digital-to-Analog Converter	38	69602B Timer/Pacer Card	69
59306A HP-IB Relay Actuator	38	69700A-69706A Resistance Output Card	67
59307A HP-IB VHF Switch	38	69709A Power Supply Control Card	67
59308A HP-IB Timing Generator	39	69720A Digital-to-Analog Voltage Converter Card	67
59309A HP-IB Digital Clock	39	69721A Digital-to-Analog Current Converter Card	67
59313A HP-IB Analog-to-Digital Converter	39	69730A Relay Output Card	67
59401A Bus System Analyzer	37	69731B Digital Output Card	67
59500A Multiprogrammer HP-IB Interface	69	69735A Pulse Train Output/Stepping Motor Control Card	67
59501B HP-IB Power Supply Programmer	39, 243	69736A Timer/Pacer Card	67
K70-59992 Rack Mount Adapter Kit (5342A, 5343A)	285	69750A Scan Control/Pacer Card	67
K34-59991A Broadband Linear Phase Comparator	271	69751A Analog-to-Digital Converter Card	67
		69752A 64 Channel FET Scanner Card	67
60000		69754A 32 Channel Relay Scanner Card	67
62000 & 63000 Modular Power Supplies (OEM)	249	69755A 16 Channel FET Scanner Card	67
62005A-62048G Modular Power Supplies	249	69770A Isolated Digital Input Card	67
62212A-62215G Dual Output Modular Supplies	249	69771A Digital Input/Analog Comparator Card	67
62410A Modular Supply Rack Mounting Tray	249	69775A Counter/Totalizer Card	67
64000 Logic Development System	157	69776A Interrupt Card	67
64100A Development Station	157	69790B Memory Card	67
64110A Development Station	157	69793A Breadboard Card	67
64200S Emulator, 8080/8085	157		
64210S Emulator, 6800	157	80000	
64220S Emulator, 8086/8088	157	82104A Card Reader (41C/CV)	585
64230S Emulator, Z8001/Z8002	157	82106A Memory Module (41C/CV)	586
64242S Emulator, 68000	157	82143A Printer/Plotter (41C/CV)	585
64250S Emulator, Z80	157	82153A Optical Wand (41C/CV)	585
64262S Emulator, 8048	157	82160A HP-IL Module	586
64302A Logic Analyzer	157	82161A Digital Cassette Drive	589
64310A Software Performance Analyzer	157	82162A Printer/Plotter	589
64500A PROM Programmer	157	82164A RS-232C Interface	590
64600S Hardware/Timing Analyzer (Mar. 1983)	157	82165A HP-IL GPIO Interface Converter	590
64620S Software/State Analyzer (Mar. 1983)	157	82166C HP-IL Interface Kit	590
64620S + 24F Advanced State/Software Training	650	82168A Acoustic Coupler	590
64650A GP Preprocessor Module (Mar. 1983)	167	82169A HP-IL/HP-IB Interface	590, 594
64817 + 24D 64000 System Pascal Programming Course	650	82170A Quad Memory Module (41C/CV)	586
69280A Breadboard Card	69	82180A Extended Functions/Memory Module	586
69321B D/A Voltage Converter	69	82181A Extended Memory Module	586
69322A Quad D/A Voltage Converter Card	69	82182A Time Module	586
69330A Relay Output Card	69	82183A Extended I/O Module	586
69331B Digital Output Card	69	82184A Plotter Module	586
69332A Open Collector Output Card	69	82500A Custom Modules	591
69335A Stepping Motor Control Card	69	82500B Custom Modules	591
69336B Scanner Card	69	82502A HP-41 Custom Magnetic Cards	591
69351C Voltage Regulator Card	69	82505 Software Development System	591
69370A D/A Current Converter Card	69	82700A 8K-Byte Memory Module	588
69380A Breadboard Output Card	69	82702A, B, C, D HP-75C Custom ROM Modules	591
69422A High Speed A/D Converter Card	69	82713A Plug-in Module Simulator	591
69423A Low Level A/D Converter Card	69	82720A, B, C, D HP-75 Custom ROM Modules	591
69430A Isolated Digital Input Card	69	82722A HP-75 Custom Magnetic Cards	591
69431A Digital Input Card	69	82821A Series 80 Data Communications Pac	595
69433A Relay Output With Readback Card	69	82825A UCSD p-System/FORTRAN-77	595
69434A Event Sense Card	69	82826A UCSD p-System Pascal	595
69435A Pulse Counter Card	69	82827A UCSD Pascal Compiler	595
69436A Process Interrupt Card	69		
69480A Breadboard Input Card	69		
69500A Unloaded Resistance Output Card	69		



82828A FORTRAN-77 Compiler	595	86290A, 86290B & 86290C Broadband Sweeper	
82829A UCSD p-System Runtime Module	595	Plug-ins for 8620C and 8350B	387
82900A CP/M System	595	86720A Frequency Extension Unit	359
82900A Opt. 001 TERM/80 Terminal Emulation System	595	88100A Graphics Tablet System Tools	635
82901M Flexible Disc Memory (5¼")	593, 618	88101A Graphics Tablet System Tools	635
82902M Flexible Disc Memory (5¼")	593, 618		
82903A 16K Memory Module			
(Series 80 Computers)	593		
82905B Printer	589, 594, 622	90000	
82906A Graphics Printer	595, 622	90100A Practical Transistor Series (Videotape) VHS(SP)	652
82908A 64K Memory Module	593	90100B Practical Transistor Series (Videotape) BETA I	652
82909A 128K Memory Module	593	90100D Practical Transistor Series (Videotape) U-matic	652
82912A 9-Inch Monitor (86B)	593	90301RA Understanding Microprocessors (Videotape) VHS(SP)	652
82913A 12-Inch Monitor (86B)	593	90301RB Understanding Microprocessors (Videotape) BETA I	652
82928A System Monitor	595	90301RD Understanding Microprocessors (Videotape) U-matic	652
82929A Programmable ROM Module	595	90307RA Microprocessor Fundamentals (Videotape)	653
82929A Opt. 001 Hybrid ROM Development System	595	90420A Digital Troubleshooting (Videotape) VHS(SP)	652
82936A ROM Drawer	594	90420B Digital Troubleshooting (Videotape) BETA I	652
82937A HP-IB Interface	594	90420D Digital Troubleshooting (Videotape) U-matic	652
82938A HP-IL Interface	590, 594	90741A Understanding Oscilloscopes (Videotape)	654
82939A Serial Interface	594	90751A How to Solder (Videotape)	655
82940A GPIO Interface	594	90838A What's a dB?-Power (Videotape)	655
82941A BCD Interface	594	97098A I/O Expander	603
82949A Printer Interface	594	98032A 16-bit Parallel Interface	604
82950A Series 80 Modem	595	98033A BCD Input Interface	604
82966A Data Link Interface	594	98034B HP-IB Interface	604
82967A Speech Synthesis Module	595	98035A Real Time Clock Interface	604
83522A 0.01-2.4 GHz RF Plug-in for 8350B	378	98036A Serial Interface	604
83525A/B 0.01-8.4 GHz RF Plug-in for 8350B	378	98040A Incremental Plotter Interface	604
83540A/B 2-8.4 GHz RF Plug-in for 8350B	380	98041A Disc Interface	604
83545A 5.9-12.4 GHz RF Plug-in for 8350B	380	98046B Intelligent Datacomm Interface	604
83570A 18-26.5 GHz RF Plug-in for 8350B	382	98253A EPROM Development Kit	602
83572A/B 26.5-40 GHz RF Plug-in For 8356	382	98255A EPROM Card	602
83590A 2-20 GHz RF Plug-in for 8350B	376	98259A Magnetic Bubble Memory Card	602
83592A/B/C 0.01-20 GHz RF Plug-in for 8350B	376	98620B Two Channel DMA Controller/Interface	602
83594A 2-26.5 GHz RF Plug-in for 8350B	376	98622A 16-Bit Interface	602
83595A 0.01-26.5 GHz RF Plug-in for 8350B	376	98623B BCD Interface	602
84811A Peak Power Sensor	419	98624A HP-IB Interface	602
85011A System Software for 8507D	455	98626A Serial Interface	602
85015A System Software for 8756S	435	98627A Color Video Interface	602
85020A/B RF Directional Bridge	432, 433	00085-150XX Series 80 ROM's	594
85021A/B/C Microwave Directional Bridge	432, 433	00087-150XX Series 80 ROM's	594
85022A System Cable Kit for 8756S	435	0960-0054 SMA-female short (50 ohm)	409
85023A/B/C/D System Verification Kit for 8756S	435	0960-0055 SMA-male short (50 ohm)	409
85031A APC-7 Calibration and Verification		1250-XXXX Series Adapters and Connectors	657
Kit for 8507D	455	1251-2277 Dual Banana plug to BNC Female	657
85032A 50 Ω Type-N Calibration Kit	455, 463	1251-2816 Dual Banana plug (for cable)	657
85033A SMA Calibration Kit	455, 463	1460-XXXX Series Cabinet Parts	661
85033B APC-3.5 Calibration Kit	463	1490-XXXX Series Slide Kits, Casters	663
85036A 75 Ω Type N Calibration Kit		1494-XXXX Series Slide Kits	660
for 8507D	455	5040-XXXX Series Rack Frames	662
85040B Reflection/Transmission Test Set	464, 466	5060-0789 Cooling Kit	663
85650A Quasi-Peak Adapter	491	5060-0796 Cooling Kit	663
85862A HPL Software Pac for 8566A or 8568A	490	5060-XXXX Control Panel Covers	663
85863A BASIC Software Library for 8566A or 8568A	490	5060-XXXX Filler Panels	662
86200 series Sweeper Plug-ins for 8620C and 8350B	390	5060-XXXX Rack Adapter Frames	662
86222A & B Sweeper Plug-ins for 8620C and 8350B	388	5060-XXXX Rack Mounting Kits	662
86240A/B/C Sweeper Plug-ins for 8620C and 8350B	389	5060-XXXX Series Racking Accessories, Covers	662, 663
86251A 7.5-18.6 GHz Plug-in for 8620C and 8350B	391	5061-XXXX Series System II Cabinet Parts	658
		9211-XXXX Series Transit Cases	664



ABOUT HEWLETT-PACKARD

Hewlett-Packard Company is in the business of developing, manufacturing and marketing computing and measuring products used by people in science, engineering, business, industry, education and medicine. These products are known for their high quality, reliability and advanced technology and include computers and computer systems, electronic instruments, instruments for chemical analysis, and electronic components.

Headquartered in Palo Alto, California, Hewlett-Packard employs approximately 70,000 people worldwide, of whom some 48,000 work in the U.S.A. Product research and manufacturing activity is highly decentralized, with facilities in the U.S., Europe, Japan, Southeast Asia, Latin America and Canada. The worldwide sales organization includes more than 100 sales and support offices in the U.S., and some 220 sales and support offices and distributorships in 70 other countries.

With 1982 sales in excess of four billion dollars, HP is ranked in the top 100 U.S. industrial corporations. About half of these sales were generated outside the United States.

HP Instruments

Hewlett-Packard's first product, developed in 1939, was an audio oscillator based on a new and innovative design. In the company's first 20 years, this oscillator was the foundation for an ever-broadening line of test and measurement instruments used primarily by engineers and scientists. The first HP catalog, published in 1943, used 24 pages to describe a total product offering of 12 instruments. This 1984 edition has 688 pages on which are detailed some 1,400 instruments, computers and accessories out of the company's total offering of more than 4,000 products.



In 1982 Yokogawa-Hewlett-Packard (YHP) was awarded Japanese industry's coveted Deming Prize for improved performance through quality control. YHP's TQC, total quality control, stressed better assessment of customer needs, incorporation of those needs into new products, and improved manufacturing processes to produce more reliable products. The TQC methods that earned YHP the Deming award have been applied throughout HP's manufacturing divisions and have significantly increased the company's success in achieving one of its long-standing objectives: "... products must be manufactured at a reasonable cost with superior workmanship."

Customers use HP instruments to evaluate the performance of their own electrical equipment, in developing products, in controlling quality and manufacturing processes, and in field service applications.

In addition to the electronics in-

dustry, major markets for HP instruments include telecommunications, aerospace, aviation, and scientific research. In fact, HP instruments are used in almost every industry where precise testing, measurement and control are required.



The HP Series 200 Computers, HP's newest family of desktop and rack-mountable computers optimized for instrument control and engineering applications, are based on the powerful 68000 microprocessor. The resulting high-speed processing improves efficiency in all applications, including measurement systems.

HP Computers

HP's first computer was introduced in 1966. Its purpose was to gather and analyze the data produced by HP electronic instruments. Today, HP computers and their peripheral devices (terminals, mass storage devices, printers and plotters) are themselves a major product line and account for a substantial portion of the company's sales.

The broad range of HP computation products and systems offers solutions for businesses, manufacturers and individuals as well as engineers and scientists.

HP leadership in key technical computer markets has been the outgrowth of the company's strong familiarity with engineering, scientific and manufacturing applications. A recent example of this was the introduction in 1982 of a desktop computer with mainframe power that is dedicated to individual use. This new computer eliminated the need for engineers and designers to "take turns" when their tasks called for the power of a large computer.

By linking networks of personal computers and terminals, powerful HP mini-computers provide mainframe capabilities for thousands of businesses and industries. Other computers are optimized for control of instrument systems, making it easier for customers to design and assemble electronic test systems.

HP's advanced data communications technology is the key to the enhanced productivity of such computerized systems. With the ability to combine words, data, and graphics, HP computer networks automate the many tasks involved. Specific application solutions along these lines are offered not only to engineers and scientists but also to manufacturers, distributors, retailers, financial institutions, hospitals, government agencies and schools.

HP Measurement Systems

Under the impact of a growing scarcity and rising cost of technical manpower, the need is accelerating for measurement systems, with their higher speed, accuracy, repea-

tability and productivity. HP instruments and computers are designed with systems in mind. In this catalog, system-ready products are marked with the symbol



In 1965, HP set about creating its own internal standard for the interfacing of all future HP instruments and HP computers. That standard became a worldwide standard, IEEE-488, and it is used by more than 170 manufacturers in 14 countries. We call this standard HP-IB, the Hewlett-Packard Interface Bus.

In all cases, the goal of HP systems is to provide essential information in useful form and in the most efficient and timely manner. The end result is improved productivity of our customers' processes and organizations—the unifying purpose of HP's business.



In keeping with a long-term commitment to measurement automation, HP instruments are designed with systems in mind. HP's dedication to instrumentation systems extends beyond a broad selection of bus-compatible instruments and computers to comprehensive support that includes help with system definition, component selection, system integration, software development, and maintenance.



Other HP Products

In addition to electronic measurement and computation products, HP manufactures a number of other product lines, all of them related by basic electronics technology. Among these are electronic components such as microwave semiconductor and optoelectronic devices. Other important fields of interest include medicine and analytical chemistry. Today, hospitals and clinics use HP equipment for patient monitoring, diagnosis and therapy, as well as data management. Analytical instruments are widely used in the chemical, energy, pharmaceutical and food industries, as well as in medical and chemical research programs for government and industry.

HP Innovation

The continuing growth of Hewlett-Packard is based to a significant degree on a strong commitment to research and development. Between 8 and 10 cents of every dollar of sales revenue is invested in R&D. In 1982, this amounted to 424 million dollars. This increasing investment has enabled HP to stay at the forefront of technology and to maintain a steady flow of new and useful products. More than half of the company's sales revenue in 1982 came from products introduced during the previous three years, a clear indication of the importance of HP's product-development efforts.

Each of HP's 50 product divisions has the primary responsibility for developing its own products. Together, the divisions account for close to 85 percent of the company's annual R&D budget. The remaining 15 percent is invested in more basic, higher risk, longer term research undertaken by HP Laboratories, the central source of technical support for the divisions. Through endeavors in areas of science and technology, the corporate laboratories



This HP 9000 computer is an example of Hewlett-Packard's commitment to designing the most advanced technology into its products. A breakthrough in VLSI technology made it possible to pack the power of a mainframe computer into a desktop work station. The five "superchips" in the foreground are the nucleus of this 32-bit computer. The chips are mounted on boards contained in the lunchpail-size module which is the computer's basic power package.

also help the company develop new areas of business. Customers benefit through access to computers and instruments that are at the forefront of technology.

HP Support

The same high level of engineering excellence that HP commits to the development of advanced products also goes into creating high quality support services. Hewlett-Packard's support organization consists of a worldwide sales and service net-

work staffed by highly trained engineers and technicians. Our support starts before you purchase an HP product and continues long after the product has been delivered.

Before you purchase a product or system, HP Sales Representatives are available to help you assess your needs and choose the product or system that meets your immediate and longer term requirements.

If your needs are best filled by an instrument system, we offer applica-



tions and training support to help you obtain full use of your system, hardware support to help maximize system up time, and software support to keep your system software current and productive.

To help you plan your system and its use, we offer the consulting and training expertise of experienced Systems Engineers. For the installation and maintenance of your system and its components, we offer the services of Customer Engineers. And for the long-term support of your system, HP offers an extensive menu of services. The menu includes contract or as-needed calibration and repair with on-site and at-HP options, as appropriate. Update services are available for both software and hardware, as is training for your own service personnel.

HP's worldwide support network ensures prompt availability of replacement parts throughout the production life of products and beyond. Replacement parts services also include parts stocking recommendations based on extensive component reliability histories and the numbers and mix of HP products to be supported.

For those products requiring consumable supplies such as recording paper, ribbons, and magnetic media, we offer fast, convenient service from well-stocked supply centers that can also provide personal computers and software, peripherals and terminals, cables and connectors, workstation furniture, books and learning aids.

HP's comprehensive support also includes extensive information services. In addition to supplying excellent hardware and software manuals, HP makes available a wide variety of no-charge publications to help you choose the HP products

that best fill your needs, to help you benefit from applications knowledge acquired by users inside and outside of HP, and to help you maintain your HP products. These publications range from new-product announcements, catalogs, product family brochures and single-product data sheets, through application notes and programming aids, to service notes and maintenance periodicals.

The support services outlined above are described in more detail in the back sections of this catalog. Your nearest HP office can either supply the support services you need or help you obtain them. The locations of HP offices are listed on the back pages of this catalog.

The HP Catalog

This catalog is divided into sections that are based on product families: circuit test systems, oscilloscopes, signal analyzers, telecommunications test equipment and so on. Many of these sections are prefaced by descriptions of basic kinds of measurements and the techniques of measurement that are associated with the featured products.

The catalog offers two different indexes. One is alphabetical by instrument type or name; the other is numerical by HP model number.

The product descriptions presented in the catalog are as complete as reasonably possible in a publication such as this. In some cases it will be necessary to refer to a data sheet for a full set of specifications. Data sheets are available on request at local HP sales offices.

The locations of HP sales and service offices are listed on the back pages of this catalog. The listing also indicates the types of products nor-

mally available through each office (not all offices handle the full line of HP products).

Contacting HP

Your calls to your local HP office will be routed to the person best qualified to give you assistance if you tell the operator your specific product interest: instruments, computers, medical, analytical, or components.

Our sales force is made up of specialists in each of these 5 major product areas. Staff engineers are always available during business hours to respond to your needs or to obtain answers from appropriate sources. Our HP sales representatives are supported by the HP systems engineering organization which has specialists in measurement and computation systems.

Information on product availability, prices and order status is immediately available through our worldwide order processing network.

Suggestions Welcomed

The purpose of this catalog is to give you the most information possible about Hewlett-Packard products, along with some company background that may be useful in reaching decisions as to product and system needs. The major emphasis in this catalog is instrument products and systems, with some representation by HP's other product categories. Literature describing these other product categories is available through your local sales office.

If you have any comments and suggestions about how we can make this catalog more useful to you, please let us know by writing to:

Hewlett-Packard Co.
Steve Duer
Catalog Manager
1819 Page Mill Road
Palo Alto, CA 94304

HEWLETT-PACKARD INTERFACE LOOP

Low Cost Interface for Battery-Operable Systems

Hewlett-Packard Interface Loop (HP-IL)

The Hewlett-Packard Interface Loop, HP-IL, is a bit-serial interface designed for low cost battery-operable systems. HP-IL allows Series 40 and Series 70 computers to be used as system controllers, capable of transmitting and receiving data, and performing a wide variety of information management and instrument control functions.

In HP-IL systems, devices are connected by two-wire cables leading from the output port of one device to the input port of the next, until all devices form a closed loop. This loop structure provides a unique capability through: auto address assignment, device capability identification, power ON/OFF control, and error checking.

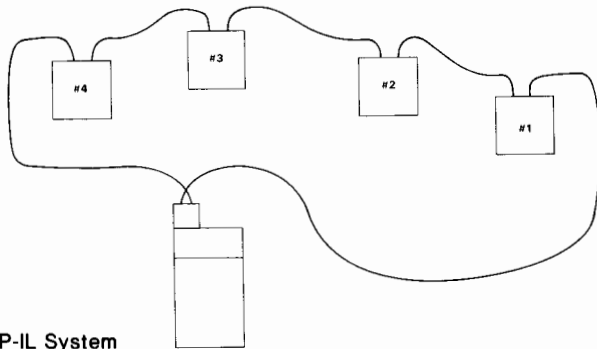

HP-IL System

Auto Address Assignment

In order to distinguish between devices on the loop, each device must have an address, a number from 1 to 30. A Series 40 or Series 70 mainframe, as the controller, uses the address to specify and control the devices on the loop. HP-IL enables the controller to assign addresses automatically, starting with the address 1 for the device next to the controller in the direction of the information transfer.

Device Capability Identification

Most HP-IL devices contain an accessory capability number that tells the system controller its device type, such as "printer" or "mass storage device". Upon execution of a PRINT command, the controller polls each device on the loop until it finds the device that responds with the appropriate accessory ID number for printers. Device capability identification frees the user from having to know the address of each device on the loop. This feature also allows software to be run and written without regard to system orientation, address switches or preassigned addresses.

Power ON/OFF Control

Several HP-IL peripherals support STANDBY mode. Peripherals can be powered on or off, under program control, to conserve battery life. The ON/OFF feature enables the use of an HP-IL system for remote applications.

Automatic Error Checking

HP-IL allows for automatic error checking of any data being transmitted on the loop. Because each character must return to the device that originally sent it, the device compares the returning character with a copy of the one that was sent. If the two do not match, an error message is generated.

Hold-Until-Ready Protocol

HP-IL provides a simple means of coordinating the transfer of data. Some devices send and receive data at high rates while other devices work at a slower pace. In the HP-IL system, devices hold each piece of information until they are ready to receive another. When ready, they pass the information to the next device. By the time a piece of information makes a complete loop, all devices are ready to accept new information. This "hold-until-ready protocol" assures that fast and slow devices can operate in the same HP-IL system.

The Versatility of HP-IL

HP-IL is an ideal, low cost interface option for those applications requiring low power and maximum portability. HP-IL also provides a link between battery-powered devices and more powerful computational products. Through HP-IL interface converters, a Series 40 or Series 70 computer can pass information to desktop computers, modems, terminals, instruments and peripherals. Another HP-IL product, the Interface Kit, allows building an HP-IL interface into microprocessor-based products, making them compatible with an HP-IL device.

HP-IB and HP-IL

HP-IL is not intended as a replacement for HP-IB, but rather as a low cost, low power alternative extending below the traditional scope of HP-IB in price and performance.

Although HP-IB and HP-IL serve the same basic function—interfacing controllers, instruments and peripherals—they differ in many respects.

1. Because of HP-IL's lower power consumption, it is usable with portable, battery-powered systems. Generally, HP-IB is not.
2. HP-IL system components will generally be low cost and have moderate performance; HP-IB system components are at the medium- to high-end of the performance spectrum and generally cost more.
3. HP-IL systems work at relatively low data rates. HP-IB systems work at relatively high data rates.
4. HP-IL allows device separations of up to 100 metres with shielded, twisted pairs (10 metres with zip cord). HP-IB requires extender hardware for long distance connections.

The HP-IL Logo

Just as the HP-IB interface is designated by the HP-IB symbol, Hewlett-Packard identifies the HP-IL interface with its own symbol. Wherever this logo appears, it indicates that that mainframe, peripheral, instrument, etc., is HP-IL compatible.



HP-IL and the Future

HP-IL adds a new dimension to Hewlett-Packard's instrumentation and computing capability. HP-IL enables battery-powered products to communicate with each other, and to communicate with personal computers, modems, terminals, instruments and peripherals. Watch for new HP-IL controllers, peripherals and instruments to be added to HP-IL's ongoing product line.





HP-IL Products and Applications Summary

Model	Application	See Page
HP-41 Handheld Computer (with HP 82160A HP-IL Interface Module)	Control: HP-IL bench/field controller Computation: Field data collection	585
HP-75C Portable Computer (with HP-IL built-in)	Control: HP-IL bench/field controller Computation: Data acquisition, field analysis Remote transaction processing	588
Series 80 Personal Computers (with HP 82938A Interface)	HP-IL bench controller field data analysis control	590
HP 82169A HP-IB Interface	Bench conversion from HP-IL to most computers, peripherals and instruments	590
HP 82164 RS-232C Interface	Bench conversion between HP-IL and RS-232C signals for terminals, modems, computers and peripherals	590
HP 82165A GPIO Interface	Bench conversion between HP-IL and parallel Digital data acquisition interface from HP-IL to most computers	590
HP 82938A Series 80 Interface	Bench conversion from HP-IL to Series 80 Personal Computers	590
HP 82166C HP-IL Interface Kit	Components that can be built into a device, providing HP-IL capability	590
HP 82161A Digital Cassette Drive	Field/bench program storage Field/bench data storage Field/bench data logging Field data collection	589

Model	Application	See Page
HP-82162A Thermal Printer/Plotter	Field/bench hard copy Data logging Simple plotting Computational hard copy	589
HP 82905B Impact Printer Opt. 248, 348, 448	Bench 80-Column Printer utility hard-copy output (for program debugging, data output, and data presentations)	589
HP 2671A/G Alphanumeric/Graphics Printers Opt. 048	Bench full-page, hard-copy output Low noise environments High-resolution graphics and text	589
HP 7470A Graphics Plotter Opt. 003	Bench color graphics and charts Paper or transparency film output (for trend analysis, result comparison and information summaries)	589
HP 82168A Acoustic Coupler (Modem)	Remote communications capability Telephone data access	590
HP 3468A Digital Multimeter	Bench/field automated measurement Scientific experimentation Lab bench experimentation & trouble shooting Bench/field automated service & diagnostic tool	84
HP 3421A Data Acquisition/Control Unit	Bench/field automated measurement, channel selections and control Lab bench experimentation and control Portable experimentation and data collection	46
HP 5384A/HP 5385A Frequency Counters	Bench, systems, field automated measurement	302





HEWLETT-PACKARD INTERFACE BUS

Versatile Interconnect System for Instruments and Controllers



Individual Hewlett-Packard Products Available with HP-IB Capability

Products Related to	Model	Product Name/Characteristics	Page
Control and Computation	85B	Personal Computer (uses 82937A Interface)	592
	86B	Personal Computer (82937A interface built-in)	592
	87XM	Personal Computer (82937A Interface built-in)	593
	9816A/S	Personal Technical Computer	602
	9826A/S	Personal Technical Computer	602
	9836A/C/S/CS	Personal Technical Computer	602
	9845B/T	Desktop Computer System 45 (uses 98034B Interface)	602
	9920A/S	Modular Computer	602
	9020B/C/S/T	Computer	603
	9030A	Computer	603
	9040A/S	Computer	603
	HP 1000 A600	Computer (2156B; uses 12009A Interface)	605
	HP 1000 A700	High Performance Computer (2137A; uses 12009A Interface)	605
	HP 1000 A900	High Performance Computer (2139A; uses 12009A interface)	605
	HP 1000 E-series	Computers (2109E & 2113E use 59310B Interface)	605
	HP 1000 F-series	High-performance computers (2117F uses 59310B Interface)	605
	Stimulus	3314A	Function Generator: 0.01 Hz to 19.99 MHz
3325A		Synthesizer/Function Generator/Sweeper: 1 μ Hz to 21 MHz	334
3335A		Synthesizer/Level Generator: 200 Hz to 80 MHz	336
3336A/B/C		Synthesizer/Level Generator: 10 Hz to 20.9 MHz	337
4140B		PA Meter/DC Voltage Source	122
5359A		Time Synthesizer: 1 ns accuracy: 50 ps increments, 100 ps jitter	321
6002A Option 001		DC Power Supply: 200 W autoranging. Listen only	242
6034A		System Power Supply: 200 W Autoranging w/status-readback	240
6129C Opt. P05 or J99		Precision Voltage Sources: \pm 50 Vdc at 5 A (requires 59301A Converter)	244
6130C Opt. P05 or J99		Precision Voltage Source: \pm 50 Vdc at 1A (requires 59301A Converter)	244
6131C Opt. P05 or J99		Precision Voltage Source: \pm 100 Vdc at 0.5 A (requires 59301A Converter)	244
6140A Opt. P05 or J99		Precision Current Source: \pm 100 mA at 100 Vdc (requires 59301A Converter)	244
6940B		Multiprogrammer (requires 59500A interface)	68
6942A		Multiprogrammer	65
8016A Option 001		Word Generator: 9 x 32 bit. Listen only	173
8018A Option 001		Serial Data Generator: 50 MHz, 2048-bit memory. Listen only	175
8112A		Programmable Low Cost Pulse Generator: 20 ns to 950 ms Period	310
8116A		Programmable Pulse/Function Generator: 1 mHz to 50 MHz	331
8160A		Programmable Pulse Generator: 20 ns to 999 ms period	312
8161A		Programmable Pulse Generator: 10 ns to 980 ms period	312
8165A		Programmable Signal Source: 0.001 Hz to 50 MHz	333
8170A		Logic Pattern Generator: 8 x 1024/16 x 512 bit	174
8180A		Data Generator: 50 MHz, 1024 bit/channel	170
8181A		Data Generator Extender	172
8340A		Synthesized Sweeper: 10 MHz–26.5 GHz	360, 368
8350B		Sweep Oscillator: 10 MHz to 40 GHz	374
8620C Option 011		Sweep Oscillator: 10 MHz to 22 GHz	386
8656A		Signal Generator: 0.1 to 990 MHz	340
8660A, C Option 005		Synthesized Signal Generators: 10 kHz to 2.6 GHz. Listen only	345
8662A		Synthesized Signal Generator: 10 kHz to 1280 MHz.	342
8663A		Synthesized Signal Generator: 100 kHz to 2560 MHz.	344
8671A		Microwave Frequency Synthesizer: 2 to 6.2 GHz	359
8672A		Synthesized Signal Generator: 2 to 18 GHz	356
8672S	Synthesized Signal Generator: 100 MHz to 18 GHz	359	
8673B	Synthesized Signal Generator: 2 to 26.5 GHz	356	
8673C/D	Synthesized Signal Generator: 50 MHz to 18, 26.5 GHz	358	
59501B	Power Supply Programmer: Isolated D-to-A Converter \pm 10 Vdc @ 10 mA	243	
Measurement	436A Option 022	Power Meter: -70 dBm to +44 dBm, to 26.5 GHz	414
	438A	Dual-channel Digital Power Meter: -70 dbm to +44 dbm, to 26.5 GHz	413
	853A	Spectrum Analyzer Display	496–501
	1630A/D	Logic Analyzer	163
	1640B Option 001	Serial Data Analyzer: 2048 bit memory	579
	1726A	Time Interval Oscilloscope	190
	1980A/B	Oscilloscope Measurement System: fully programmable	182
	19800/19801	Waveform Measurement Library: Application Software for Series 200 and Series 80 computers	183
	1950A	Two Channel Expansion Module for 1980 System	182
	1965A	Gated Universal Counter for 1980 System	183
	19860A	Digital Waveform Storage for 1980 System	183
	2250	Measurement & Control System	56
	2804A Option 010	Quartz Thermometer: 0.05°C accuracy	647
	3040A	Network Analyzer: 50 Hz to 13 MHz	440
	3421A	Data Acquisition/Control Unit	46
	3437A	System Digital Voltmeter: high speed, 3½ digits	93
	3455A	Digital Voltmeter: 5½ or 6½ digits, auto calibration	94

Individual Hewlett-Packard Products Available with HP-IB Capability (cont.)

Products Related to	Model	Product Name/Characteristics	Page
Measurement (cont.)	3456A	Digital Voltmeter: 3½ to 6½ digit voltmeter 1 nV sensitivity	90
	3478A	Digital Multimeter: 3½ to 5½ digits; 5 functions	88
	3497A	Data Acquisition Control Unit	52
	3582A	2-channel Real Time (FFT) Spectrum Analyzer	518
	3585A	Swept Spectrum Analyzer: 20 Hz to 40 MHz	477
	3586A/B/C	Selective Level Meter: 50 Hz to 32.5 MHz	480
	3717A	Wideband 70 MHz modem	561
	3724/25/26A	Baseband Analyzer	559
	3746A	32.5 MHz Selective Level Measuring Set: CCITT and Bell FDM Systems	551
	3764A	Digital Transmission Analyzer	546
	3776A	PCM Terminal Test Set: CEPT/CCITT networks	541
	3776B	PCM Terminal Test Set: Bell/Japanese/CCITT networks	541
	3771A Option 005	Data Line Analyzer: CCITT measurement standards	570
	3771B Option 005	Data Line Analyzer: Bell measurement standards	570
	3779C	Primary Multiplex Analyzer: CEPT 2 Mb/s PCM systems	542
	3779D	Primary Multiplex Analyzer: Bell 1.5 Mb/s PCM systems	542
	3781A/3782A	Pattern Generator/Error Detector: CEPT and CCITT PCM/TDM systems	545
	3781B/3782B	Pattern Generator/Error Detector: Bell PCM/TDM systems	545
	3785A	Jitter Generator and Receiver: CEPT PCM/TDM systems	547
	3785B	Jitter Generator and Receiver: Bell PCM/TDM systems	547
	4140B	PA Meter/dc Voltage Source	122
	4145A	Semiconductor Parameter Analyzer	124
	4191A	RF Impedance Analyzer	108
	4192A	LF Impedance Analyzer	110
	4193A	Vector Impedance Meter	112
	4262A Option 101	Automatic LCR Meter	114
	4274A	Multifrequency LCR Meter: 10 steps, 100 Hz to 100 kHz	100
	4275A	Multifrequency LCR Meter: 10 steps, 10 kHz to 10 MHz	100
	4276A	LCZ Meter	104
	4277A	LCZ Meter	104
	4280A	C Meter/CV Plotter	116
	4945A Option 010	Transmission Impairment Measurement System (TIMS)	572
	4955A	Protocol Analyzer	580
	5005B	System Signature Multimeter	142
	5006A	Signature Analyzer	145
	5180A	Waveform Recorder	176
	5312A	HP-IB interface (Talker) for 5300B Counter System	304
	5316A	Universal Counter: 0-100 MHz	298
	5328A Option 011	Universal Counter: to 512 MHz, 10 ns Time Interval	296
	5334A	Automatic Universal Counter: 100 MHz/1.3 GHz, 2 ns TI	294
	5335A	Automatic Universal Counter: 200 MHz/1.3 GHz, 2ns TI	291
	5340A Option 011	Automatic Microwave Counter: 10 Hz to 18 GHz	287
	5342A Option 011	Automatic Microwave Counter: 10 Hz to 18 GHz	284
	5343A Option 011	Microwave Frequency Counter: 10 Hz to 26.5 GHz	284
	5344S	Microwave Source Synchronizer .5 GHz to 18 GHz	286
	5345A Option 011,012	General Purpose Plug-In Counter	280
	5355A	Automatic Frequency Converter plug-in for 5345A	283
	5363B	Time Interval Probes	290
	5370B	Time Interval Counter: ± 20 ps single-shot resolution	288
	5384A	225 MHz Frequency Counter	302
	5385A	1 GHz Frequency Counter	302
	5420A	Digital Signal Analyzer	523
	5423A	Structural Dynamics Analyzer	523
	5501A	Laser Transducer	644
	5528A	Laser Measurement System	644
	6940B	Multiprogrammer (requires 59500A interface)	63
	6942A	Multiprogrammer	63
	8182A	Data Analyzer: 50 MHz real-time capability; 1024 bit/channel	170
	8501A	Storage Normalizer for 8505A RF network analyzer	451
	8503A & 8503B	S-Parameter Test Set: 50 or 75 Ohm, for 8505A	452
	8505A	RF Network Analyzer: 500 kHz to 1.3 GHz	448
	8507D	Network Analyzer Subsystem: 500 kHz to 1.3 GHz	454
	8566A	Spectrum Analyzer: 100 Hz to 300 GHz	482, 487
	8568A	Spectrum Analyzer: 100 Hz to 1.5 GHz	482, 484
	8569B	Spectrum Analyzer: 10 MHz to 115 GHz	492
	8756A	Scaler Network Analyzer: 10 MHz to 40 GHz	430
	8901A	Modulation Analyzer: 150 kHz to 1.3 GHz	530
	8901B	Modulation Analyzer: 150 kHz to 1.3 GHz	530
	8902A	Measuring Receiver: 150 kHz to 1.3 GHz	532
	8903A	Audio Analyzer: 20 Hz to 100 KHz	535
	8954A	Transceiver Interface	539
	8956A	System Interface	539
	8970A	Noise Figure Meter: 10 to 1500 MHz	422
	11729B	Carrier Noise Test Set: 5 MHz to 18 GHz	361
	85650A	Quasi-Peak Adapter	491

Individual Hewlett-Packard Products Available with HP-IB Capability (cont.)

Products Related to	Model	Product Name/Characteristics	Page
Switching Scanning Translation or Timing	2250	Measurement and Control Subsystem	56
	3421A	Scanner: to 30 channels; A/D converter	46
	3488A	Versatile switching for automated testing (VHF, matrix, G.P.)	60
	3495A	Scanner: to 80 channels, low thermal; (to 40 relay channels)	59
	3497A	Data Acquisition Control Unit	52
	3754A	25 MHz Access Switch (requires 3755A switch controller)	552
	3756A	90 MHz Switch (requires 3755A)	552
	3757A	8.5 MHz Access Switch (requires 3755A)	552
	3777A	Telecommunications Channel Selector: up to 30 channels; dc to 110 kHz	543
	6940B	Multiprogrammer (requires 59500A interface)	63
	6942A	Multiprogrammer (no interface required)	63
	9411B	Switch Controller	71
	9412A	Modular Switch (requires 9411B switch controller)	71
	9413A	VHF Switch (requires 9411B)	71
	9414A	Matrix Switch (requires 9411B)	71
	11713A	Attenuator/Switch Driver (controls coax switches, step attenuators and microwave matrix switches)	402
	37201A	HP-IB Extender Twisted-Pair or Modems	40
	37203A/L	HP-IB Extender: Coax and Fiber Optics	41
	59301A	ASCII-to-Parallel Converter: string to 16 characters	38
	59303A	Digital-to-Analog Converter	38
59306A	Relay Actuator: for programmable switches, attenuators	38	
59307A	VHF Switch: two 50 Ohm, bidirectional, dc to 500 MHz	38	
59308A	Timing Generator	39	
59309A	Digital Clock: month, day, hour, minute, second	39	
59313A	Analog-to-Digital Converter	39	
59501B	Power Supply Programmer: isolated D-to-A converter ± 10 V dc at 10 mA	243	
Storage	3964A Option 007	Instrumentation Tape Recorder: 4 channel Listen only	267
	3968A Option 007	Instrumentation Tape Recorder: 8 channel Listen only	267
	9121D/S	3.5" Flexible Disc: 540K bytes (Dual); 270K bytes (Single) of random access storage.	618
	82901M	5¼" Flexible Disc: 540K bytes random access storage (dual-drive).	618
	9895A	8" Flexible Disc: 2.36M bytes mass storage (dual-drive).	618
	9134XV	5¼" Micro-winchester Disc: 4.6/9.6M bytes storage.	619
	9133V, XV	Combination Storage Unit: 5½" Winchester (4.6/14.6M bytes) + 3½" microfloppy (270 bytes)	619
	7970E	½" Magnetic Tape Subsystem: 40M bytes formatted capacity	617
	7974A	½" Magnetic Tape Subsystem: 40M bytes formatted capacity	617
	7976A	½" Magnetic Tape Subsystem: 140M bytes formatted capacity	617
Data Entry, Displays	1346A	HP-IB Display Module	220
	1347A	HP-IB Display	220, 637
	1351S	Graphics Display System	218, 638
	2563A	Line Printer: 300 lines/minute dot matrix	624
	2602A	Daisywheel Printer	622
	2635A	Printing Terminal	623
	2671A	Alphanumeric Thermal Printer: 80 columns	623
	2671G	Graphics Thermal Printer: 80 columns	623
	2673A	Intelligent Graphics Printer: 80 columns	623
	2680A, 2688A	Page Printer	624
	2932A	Impact Printer	623
	37461A	Display	551
	5150A Option 001	Alphanumeric Thermal Printer: 20 Columns. Listen only	269
	7470A	Graphics Plotter: 2-pen	628
	7475A	Graphics Plotter: 6-pen	628
	7580B, 7585B	Large Format Drafting Plotters	632
	9111A	Graphics Tablet: graphics input	634
9872T	Graphics Plotter: 8-pen Flatbed Plotter	630	
9876A	Thermal Graphics Printer: 480 lines/minute	623	
Interface Cabling	10833A-10833D	HP-IB Interconnection Cables	37
	10834A	HP-IB Interconnection Cable Adapter: 2.3 cm (.91 in)	37
HP-IB Extension	37201A	HP-IB Extender: Twisted Pair or modems	40
	37203A/L	HP-IB Extender: Coaxial or Fiber Optic Cable	41
Design/Serviceing	59401A	Bus System Analyzer	37



HEWLETT-PACKARD INTERFACE BUS

Versatile Interconnect System for Instruments and Controllers



Standard HP-IB Measurement Systems

Many application requirements can be satisfied with a standard HP-IB measurement system — a system assembled, tested, and

documented by Hewlett-Packard. Preconfigured systems save you design and setup time, and HP guarantees overall specified

system performance. Installation and service contracts are available from your local HP Sales and Service Office.

Standard HP-IB Measurement Systems

Application	Model	Use Controller	System name/characteristic	Page
Data Logging, Acquisition, and Control	2250	1000	Industrial Data Acquisition & Control	56
	3054A	85/9825/9826	Fast, flexible, and precise data acquisition system with a wide choice of controllers	48
	3054C	9835/9845	Computer based automatic data acquisition/control system	51
	3054DL	1000	Complete data logger	50
	3056DL	85	Complete data logger (HP-IB & HP-IL)	45
Network Analysis	8408B	85	Automatic Microwave Network Analyzer: 500 MHz to 18 GHz	466
	8409C	9845/9826/9836	Automatic Microwave Network Analyzer: measures transmission and reflection parameters, 110 MHz to 18 GHz.	467
	8507D	9816/9826/9836	Automatic RF Network Analyzer: measures complex impedance, transfer functions, group delay; 500 kHz to 1.3 GHz.	454
	8756S	9816/9826/9836	Automatic Scalar Network Analyzer: measures insertion loss, gain, return loss, SWR, reflection coefficient & power	430
Spectrum Analysis	8568S	Series 200, Models 16, 26, or 36	Automatic Spectrum Analyzer: covers 100 Hz to 1.5 GHz; exceptional frequency tuning accuracy and resolution.	490
	8566S	Series 200, Models 16, 26, or 36	Automatic Spectrum Analyzer: covers 100 Hz to 22 GHz; exceptional frequency tuning accuracy and resolution.	490
Frequency Stability Analysis	3047A	9845/9836	Spectrum Analyzer System: high resolution and phase noise measurements	520
Signal Generator Calibration	8952A	Series 200	Performance verification for HP 8640B, 8656A, 8662A Signal Generators	533
Transceiver Testing	8953A	85/9816/9826/9836	Transceiver Test Set for AM and FM transceivers, 150 kHz to 990 MHz.	538
	8955A	9816/9836/9845	RF Test System for AM and FM transceivers, to 1000 MHz, transmitters to 120 W.	537
Circuit Testing	DTS-70	1000	Digital Test System: fast, accurate fault location on loaded printed circuit boards.	140
	3061A/3062A	200 Series	In circuit functional Test System	134
	3065C	200 Series	Analog Board Test System: Fast, accurate fault location on loaded printed circuit boards. Option 100 test microprocessors	136
	55005S	85	Semiautomatic, at-speed functional testing of digital products	141
Digital IC Testing	5046S	9816/9826/9836	Digital IC Test System: Reduces production costs through the isolation of faulty components prior to printed circuit board loading.	130
Frequency Division Multiplex (FDM) Network Surveillance	3046A/B	85	Frequency Division Multiplex (FDM) network surveillance system: automates 3586A/B Selective Level Meters	557
	37050S	1000	FDM Network Monitoring System: simultaneous control of multiple selective level measuring sets.	553
	37051S	9816	FDM Measurement System: sequential control of multiple selective level measuring sets.	553
Semiconductor/Component Testing	4061A	9835/9845	Semiconductor/Component Test System: evaluation of fundamental characteristics of semiconductor and electronic components (I-V, HF, C-V, + quasi static C-V)	126
	4062A	1000	AC/DC Parametric Test System; 48-pin matrix switch	128
Pressure Recording	2820B	9825	Pressure recording system: displays, prints, and records pressure test data from oil and gas wells. Used with the 2813B Quartz Pressure Probe.	646
Power Sensor Calibration	436A-E40	85	Calibrates RF & MW power sensors; good for metrology labs.	417



HEWLETT-PACKARD INTERFACE BUS

Versatile Interconnect Systems for Instruments and Controllers



HP-IB Training and Support

Hewlett-Packard has field sales people trained in electronic instruments, desktop computers and computer systems to assist you in configuring HP-IB measurement systems. Also available for technical consultation are computing controller systems engineers and HP-IB instrumentation specialists.

HP-IB training courses on HP-IB controllers and instruments are listed below. Courses are conducted at selected Hewlett-Packard locations. For specific information on schedules and locations, contact your nearest HP office.

Instrumentation Systems

Course Name	Duration
• HP-IB Programming on the Series 200	4 days

Computer Systems

Course Name	Duration
• Instrument Interface with HP-IB	4 days

Desktop Computer Systems

Course Name	Duration
• HP BASIC Programming	4 days
• 9845 BASIC Operating and Programming	5 days
• BASIC Language I/O-Programming	4 days
• Series 200 Pascal Programming	5 days
• 9000 Family Basic Language Operating and Programming	5 days
• HPL Operating and Programming	5 days
• Series 80 Beginners Programming	2 days
• Series 80 General I/O Programming	3 days
• Series 80 Assembly Language	3 days

Service and Warranty Considerations

Hewlett-Packard has dedicated measurement system service people who perform on-site maintenance of HP instrumentation on both customer configured systems as well as HP configured systems. Service contract coverage is available to meet your specific measurement system service needs and can be tailored to include extended warranty, calibration and extended hours of coverage. Contact your local sales and service office for further information on HP-IB service contract information.

Every HP-IB device and HP configured system carries a standard Hewlett-Packard warranty appropriate to that product. The warranty period for each product will be provided on request at the time of sale and is specified in documentation supplied with the product. HP takes responsibility for standard HP-IB systems performing as specified. However, software or interfacing which has not been provided by Hewlett-Packard as part of a standard system delivered by HP is not covered by this warranty.

In all cases, overall operational responsibility for those HP-IB *systems assembled by a customer* from individual HP-IB devices shall rest with the customer.

HP-IB Specifications Summary

Interconnect Devices

Up to 15 maximum on one contiguous bus.

Interconnection Path

Star or linear bus network; total transmission path length 2 metres times number of devices or 20 metres, whichever is less. Operating distances can be extended; see pages 40 and 41.

Message Transfer Scheme

Byte-serial, bit-parallel asynchronous data transfer using locked 3-wire handshake technique.

Data Rate

One megabyte per second maximum over limited distance; 250-500 Kbytes per second typical over full transmission path (actual data rate depends on individual device characteristics).

Address Capability

Primary addresses, 31 TALK and 31 LISTEN; secondary (2-byte) addresses, 961 TALK and 961 LISTEN. Maximum of 1 TALKER and up to 14 LISTENERS at a time.

Control Shift

In systems with more than one controller, only one can be active at a time. A currently active controller can pass control to another, but only designated system controller can assume control over others.

Interface Circuits

Driver and receiver circuits are TTL-compatible.

Connector Lock Screw Compatibility

HP-IB products delivered now and in recent years are equipped with connectors having ISO *metric-threaded* lock screws, and stud mounts. (Very early HP-IB products have non-metric parts, but are readily distinguished from the metric by color: metric-threaded parts are black and stamped with the letter "M" whereas non-metric parts have a shiny nickel finish.) HP-IB Metric Conversion Kit (P/N 5060-0138) is available to convert these early instruments.

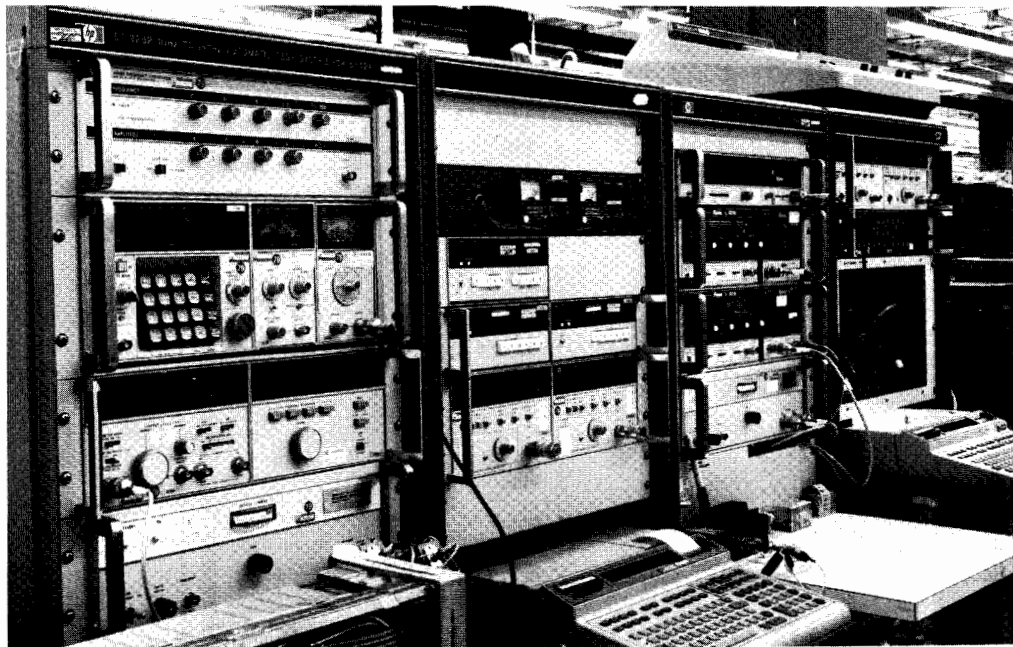

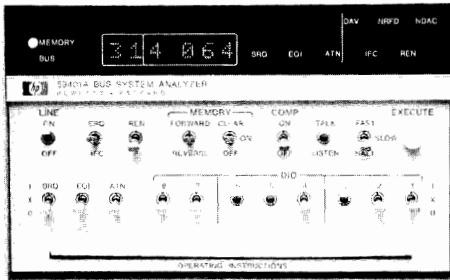

59401A

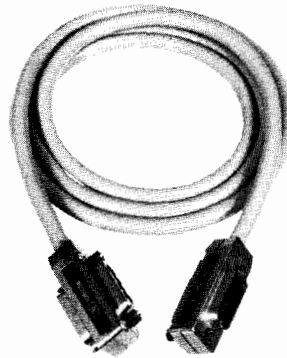

10833A/B/C/D



10834A

59401A Bus System Analyzer

The HP-IB (IEEE 488) concept has greatly simplified many of those things which have in the past made instrument interfacing a burdensome task. Even so, software errors can occur if the system designer does not completely understand the bus system or the capabilities of the instruments and other devices being interfaced. Hardware problems can occur if the instruments/devices are not functioning properly, or if they are not completely compatible with the bus standard.

The 59401 Bus System Analyzer is especially useful in design and service work. It simplifies and speeds up the diagnosis of software and hardware problems by allowing the user to see the status of all bus lines, including the actual characters on the bus data lines. Because the 59401A can also drive all bus lines, it can completely exercise another Talker, Listener or Controller—which is especially useful in verifying compatibility of new or user-designed products with the HP-IB.

There are several choices of analyzer operating speed. It may be operated at one character at a time (useful for software debugging), at 2 characters per second, or at regular bus speed. It may also be operated at a variable rate as determined by the external clock input.

The analyzer's 32 character memory can be used to store bus characters in the Listen mode, or to output characters to the bus in the Talk mode. When the analyzer is in the Compare mode, a stream of bus traffic may be stopped on a pre-selected character—and at that time, a trigger pulse is available, which is very useful when analyzing transient or timing problems related to the bus.

59401A Specifications

Display: monitors all bus lines. Represents data lines, any memory location, or DIO front panel switch settings; in octal code and ASCII character.

Listen mode: stores up to 32 characters of bus traffic in memory for real time and repetitive testing. In Compare mode, halts bus traffic when a selected character is present, and user can display any one of the previous 31 characters stored in memory.

Timing: accept <750 ns; ready <750 ns.

Talk mode: bus lines can be driven directly from front panel switches; memory can be loaded from front panel switches for driving bus with a 32 character sequence.

Timing: (1) data changed >500 ns before DAV pulled low; (2) ATN driven low >1 μ s before DAV pulled low; (3) DAV driven high <700 ns after NDAC is false; (4) DAV driven low <700 ns after NRFD is false, if conditions 1 and 2 are met.

Operating speeds: one character at a time, 2 characters per second, regular bus speed, or variable rate determined by external clock input; in either Listen or Talk mode.

External clock input: 1 standard power TTL gate input; \leq 10 MHz repetition rate.

Compare output: provides 1 standard power TTL gate output (LOW TRUE) sync pulse when bus character is same as front panel switches.

HP-IB load: 1 bus load (capable of driving 14 other bus devices).

General

Temperature ranges: operating, 0 to 50°C; storage, -40 to +75°C.

Humidity: 95% relative, 0 to 40°C.

Power requirements: 100, 120, 220, or 240 V +5%, -10%; 48 to 66 Hz; \leq 42 VA.

Size: 145.5 H, 205.1 W, 495.3 mm D (5.730" x 8.075" x 19.500").

Weight: net, 5.64 kg (12.44 lb).

Accessories

5061-0089 front handle kit

10833B 2 m (6.6 ft) bus cable, furnished

59401A Bus System Analyzer

HP-IB Interconnection Cables

Cables for interconnecting HP-IB devices are available in four different lengths. The connector block at both ends of each HP-IB cable (photo above) has a plug on one side and a matching receptacle on the other, so that several cables may be conveniently connected in parallel, thus simplifying system interconnection. Lock screws provide for secure mounting of each connector block to an HP-IB instrument, or to another cable connector block.

SPECIAL NOTE: HP-IB cables are not always included with individual HP-IB devices, particularly those that normally connect directly to an HP computing controller. (The HP-IB interface for HP computing controllers contains the necessary cable and connector). Product listings in this catalog should be checked to see if HP-IB cables are furnished.

The 10833 series of cables feature an improved shielding design to help improve RFI levels in systems. This series of cables, with the RFI shielding, exhibits significantly lower radiated emissions than previous HP-IB cables.

The 10834A adapter is a shielded HP-IB to HP-IB adapter. It provides additional clearance between the HP-IB cable and the rear panel of the instrument. This allows easier access to switches, cables, and other connectors that may be in close proximity to the HP-IB connector.

Ordering Information

10833A HP-IB Cable, 1m (3.3 ft)

10833B HP-IB Cable, 2m (6.6 ft)

10833C HP-IB Cable, 4m (13.2 ft)

10833D HP-IB Cable, 0.5m (1.6 ft)

10834A Adapter

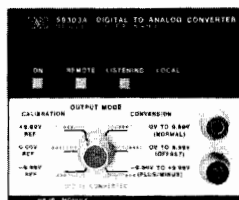

59303A

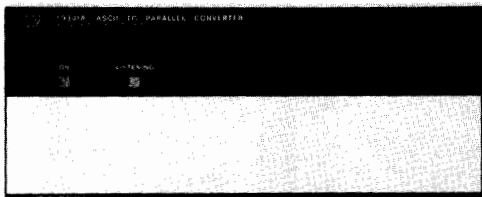

59301A

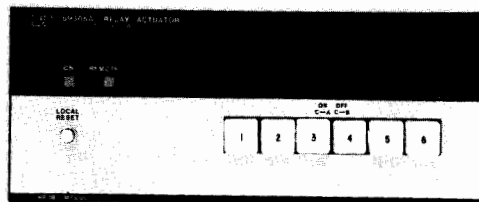

59306A

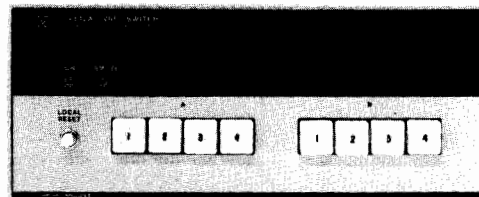

59307A

HP-IB Accessory Modules

Modules in the HP 59300, 59400 and 59500-series are ideal building blocks for use with instruments to extend measurement capabilities. Modules listed here can be interconnected via the HP-IB to HP measuring instruments, signal sources and recording devices capable of operating directly on the HP-IB. In addition, these modules frequently serve as useful ways to interconnect with devices which are not themselves capable of direct HP-IB operation.

Instrument requirements differ. Some only output or accept data on the HP-IB. Others can be remotely programmed by ASCII characters sent along the bus. These modules can work with instruments on any of these levels with or without a controller. Each module having controls can be operated stand-alone from its front panel, or it can be placed in automatic operation under program control.

Module provision for stand-alone, local operation also has important system benefits. The operator can set up and check out the system under manual control, avoiding otherwise complex and time consuming error tracing. Each module has status indicator lights that make it easy to monitor operation.

59301A ASCII-to-Parallel Converter

Accepts byte-serial ASCII characters from the HP-IB and converts them to parallel output. In operation, ASCII characters transmitted serially along the bus are converted into 4-bit characters with the first ASCII character received being interpreted as the most significant digit. A string of up to 16 characters terminated by linefeed is converted and placed upon the output lines. The linefeed character causes the 59301A to output a print command (strobe).

With the 59301A, instruments controlled via BCD or binary can be operated using HP-IB. For example, the 59301A can be used with HP 6129C through 6131C and 6140A (Option J99 or P05) digitally-controlled power supplies for HP-IB programmable voltage and current. The 59301A can additionally be used to control other functions using its hexadecimal format.

General

Size: 101.6 mm H¹ x 212.9 mm W x 294.6 mm D (4" x 8.38" x 11.6").
Weight: net 1.70 kg (3.78 lb). Shipping 2.33 kg (5.16 lb).

59301A ASCII-to-Parallel Converter

59303A Digital-to-Analog Converter

Accepts a string of serial ASCII characters and converts any three consecutive input digits to an analog output voltage, accurate to 0.1% in 30 μ s. Fully programmable via the HP-IB or manually operated from the front panel. A concentric control on the front panel makes it easy to select the digit group for conversion and the output mode. The

¹Height includes feet. With feet removed height is 88.1 mm (3.45").

conversion switch is used to select the three digits of the character string that the DAC will change into analog voltage. The three output modes (NORMAL, OFFSET, and PLUS/MINUS) make the converter convenient for use directly with a variety of data logging devices, avoiding the need for auxiliary equipment to shift zero level or change polarity.

A primary application for the HP 59303A is to present on a logging device the data points being taken with a measuring instrument (like a frequency counter). A controller is not required for operation. Compatible logging devices include strip chart recorders, X-Y plotters, and displays.

General

Size: 101.6 mm H¹ x 105.9 mm W x 294.6 mm D (4" x 4.17" x 11.6").
Weight: net 2.61 kg (5.80 lb). Shipping 3.17 kg (7.04 lb).

59303A Digital-to-Analog Converter

59306A Relay Actuator

Has six Form-C relays that provide for control of external devices either manually from front panel pushbuttons or remotely from the HP-IB. Relay contacts are specified to switch 24 V dc or 115 V ac at 0.5 A. Each relay can be programmed independently or multiple relays can be switched together. Front panel pushbuttons light to indicate the state of each relay.

The 59306A is ideal for providing control of microwave coaxial switches (HP 8761 A/B) as well as control of microwave programmable step attenuators (HP 8494 through 8496 G/H) using external dc power supplies.

General

Size: 101.6 mm H¹ x 212.9 mm W x 294.6 mm D (4" x 8.38" x 11.6").
Weight: net 2.64 kg (5.87 lb). Shipping 3.23 kg (7.18 lb).

59306A Relay Actuator

59307A Dual VHF Switch

This module provides two single pole 4-throw switches controlled from front panel pushbuttons or remotely from the HP-IB. The 59307A is a dc to 500 MHz 50 Ω switch designed to maintain fast pulse transition times. The switches are independent and bidirectional for optimum use in multiplexing 50 Ω signal lines into measuring instruments. The 59307A is ideal to switch a standard delay, frequency, or voltage into a measurement loop for purposes of system calibration.

General

Size: 101.6 mm H¹ x 212.9 mm W x 294.6 mm D (4" x 8.38" x 11.6").
Weight: net 2.64 kg (5.87 lb). Shipping 3.23 kg (7.18 lb).

59307A VHF Switch

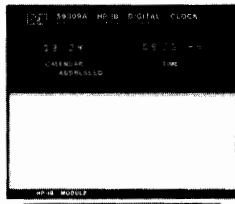

59309A

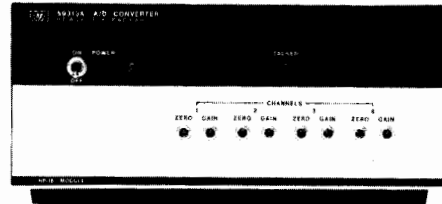

59313A

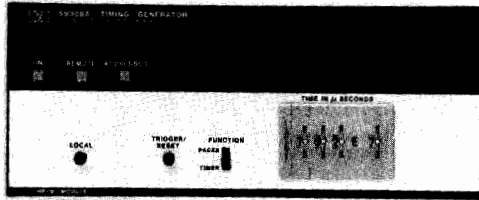

59308A

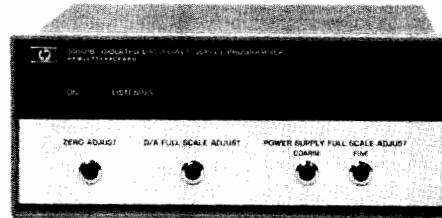

59501B

59308A Timing Generator

Provides a timing reference as either a Timer (digital delay generator) or a Pacer (precision time marker generator). In the Timer mode, a timing pulse is provided at a specified interval after a trigger is received. In the Pacer mode, a train of timing pulses of a specified period is provided on and after the receipt of a trigger.

The timing pulses are output on rear-panel BNC connectors and signal the HP-IB with appropriate signals. The timing can be set via the front panel thumbwheel switches, or via HP-IB. Times from 1 μs to more than a day are available. Trigger inputs are available via HP-IB commands and rear panel connector. Outputs are available from both TTL and ECL levels, with switch selection of a squarewave or pulse output positive- or negative-going edge. Output pulses are 500 ns ± 100 ns wide, and rise time is < 50 ns into 50 Ω.

General

Size: 101.6 mm H¹ x 105.9 mm W x 294.6 mm D (4" x 4.17" x 11.6").
Weight: net 1.70 kg (3.78 lb). Shipping 2.84 kg (6.31 lb).

59308A Timing Generator

59309A HP-IB Digital Clock

Displays month, day, hour, minute, and second, and upon command will output time via the interface bus. Time can be set into the clock by local control, or by remote commands received from the HP-IB. The clock accepts a small internal battery which can provide more than a day's standby in case of short power interruptions. Additionally, an auxiliary power supply such as the K10-59992 can sustain the clock for up to one year.

General

Size: 101.6 mm H¹ x 105.9 mm W x 294.6 mm D (4" x 4.17" x 11.6").
Weight: net 1.70 kg (3.78 lb). Shipping 2.84 kg (6.31 lb).

59309A HP-IB Digital Clock

¹Height includes feet. With feet removed height is 88.1 mm (3.45").

59313A Analog-to-Digital Converter

Four channel converter allows analog data with a full scale range of up to ± 10 V dc to be digitized and transmitted via HP-IB to a computing controller.

On command from the controller, the instrument can be programmed to perform a single conversion or a series of internally-paced conversions in six selectable rates of up to 200 per second on one channel, or up to 50 per second on each of four channels. Sampling can also be initiated externally by a TTL transition or contact closure to ground. Included is a program-controlled reverse channel capable of driving small lamps, relays or TTL devices.

General

Size: 101.6 mm H¹ x 212.9 mm W x 345.4 mm D (4" x 8.38" x 13.6").
Weight: net 5.45 kg (12.0 lb). Shipping 6.36 kg (14.0 lb).

59313A Analog-to-Digital Converter

59501B Power Supply Programmer (isolated DAC)

This single-channel digital-to-analog converter can control a wide range of power supplies (output voltage, or current), as well as other analog programmable devices. It may also be used as a low level signal source, depending on the speed of the controller. It has two output ranges (0–1 and 0–10 V dc in unipolar mode; –1 to +1 and –10 to +10 V dc in bipolar mode), as well as photo-isolators which electrically separate HP-IB control and data lines from power supply circuitry by up to 600 V dc. (Additional details on page 243)

General

Size: 101.6 mm H¹ x 212.9 mm W x 194.6 mm D (4" x 8.38" x 11.6").
Weight: net 2.61 kg (5.80 lb). Shipping 3.17 kg (7.04 lb).

59501B Power Supply Programmer

Model	Description	Dimensions—max. height x width x depth mm (inches)	Net Weight kg (lb)	Shipping Weight kg (lb)
59301A	ASCII-to-Parallel Converter	101.6 x 212.9 x 294.6 (4 x 8.38 x 11.6)	1.70 (3.78)	2.32 (5.16)
59303A	Digital-to-Analog Converter	101.6 x 105.9 x 294.6 (4 x 4.17 x 11.6)	2.61 (5.80)	3.17 (7.04)
59306A	Relay Actuator	101.6 x 212.9 x 294.6 (4 x 8.38 x 11.6)	2.64 (5.87)	3.23 (7.18)
59307A	VHF Switch	101.6 x 212.9 x 294.6 (4 x 8.38 x 11.6)	2.64 (5.87)	3.23 (7.18)
59308A	Timing Generator	101.6 x 212.9 x 294.6 (4 x 8.38 x 11.6)	2.10 (4.67)	3.83 (8.51)
59309A	HP-IB Digital Clock	101.6 x 105.9 x 294.6 (4 x 4.17 x 11.6)	1.70 (3.78)	2.84 (6.31)
59313A	Analog-to-Digital Converter	101.6 x 212.9 x 345.4 (4 x 8.38 x 13.6)	5.45 (12.0)	6.36 (14.0)
59401A	Bus System Analyzer	145.5 x 205.1 x 495.3 (5.73 x 8.08 x 19.5)	5.64 (12.44)	9.1 (20)
59501B	Power Supply Programmer	101.6 x 212.9 x 294.6 (4 x 8.38 x 11.6)	2.61 (5.80)	3.17 (7.04)

HEWLETT-PACKARD INTERFACE BUS

Versatile Interconnect System for Instruments and Controllers

Model 37201A



- Transparent extension of HP-IB systems
- Operation over twin-pair cable or modems
- Automatic error detection and correction
- High immunity to electrical interference
- Multi-point (multi-drop) capability
- Auto-dialler interface

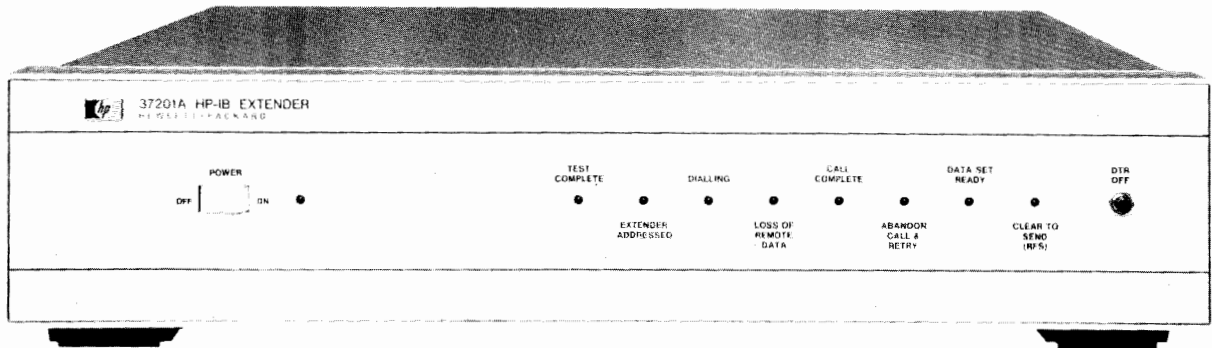

The 37201A HP-IB Extender overcomes the limited range available with direct HP-IB cable interconnections. Each 37201A converts parallel data from the interface bus into a serial bit stream, suitable for transmission to a remote site, and reconverts incoming serial data to bit-parallel HP-IB format. An HP-IB system can therefore be split into two or more discrete parts separated by HP-IB Extenders and a serial data link. A range of 1000 metres is obtainable if twin-pair cable is used for the transmission path, and virtually unlimited range is available if a modem link is used. Communication between Extenders is full duplex, allowing information to flow in both directions simultaneously.

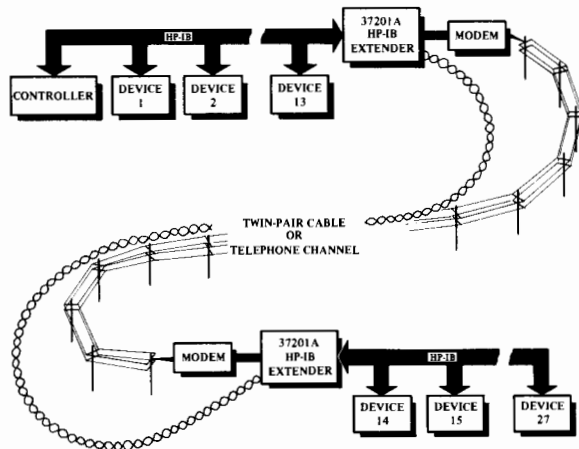

Point-to-point connection using twin twisted pair cable or full duplex modem link.

A pair of HP-IB Extenders provides a transparent interface between local and remote HP-IB devices. Program control of the 37201A is seldom necessary. Consequently, HP-IB Extenders can be added to an HP-IB system usually without any modification of software and without writing special routines to control the Extenders. The 37201A supports the full range of HP-IB functions with the exception of Parallel Poll and Pass Control.

Integrity of HP-IB data and control signals is assured by an automatic error-checking protocol, which retransmits any data corrupted in transmission. The 37201A is in general compliance with each of the following standards and supports their major capabilities:

- IEEE Standard 488-1978
- ANSI Standard MC1.1
- IEC Standard 625-1

Twin-Pair Cable Operation

Twin twisted-pair cable provides a simple inexpensive transmission medium for distances up to 1000 metres. The serial data rate is nominally 20 kbit/s. Suitable cable is available as an accessory (HP Part Number 8120-1187). Transformer coupling within the 37201A gives a high degree of immunity from the effects of common mode signals. This, combined with the automatic error correction capability, makes the 37201A suitable for use in an electrically hostile environment.

Modem Link Operation

The 37201A is designed to operate with a wide range of synchronous and asynchronous modems over private lines, leased lines, or the public switched (dial-up) telephone network. The data interface is compatible with EIA RS-232C and CCITT V.24 and V.28 standards. Asynchronous data rates provided are: 150, 300, 600, and 1200 bit/s. For synchronous modems, operation at any bit rate up to 19.2 kbit/s is possible. Besides operating in point-to-point mode, the 37201A can be used with modems in a multi-point (multi-drop) leased line configuration involving up to 31 remote sites. When operating over the public switched telephone network, connections may be dialled manually. Alternatively, an external auto-dialler may be used to make connections under program control. The 37201A has an RS-366/V.25 interface to permit operation with an auto-dialler.

The error checking/correcting communications protocol used in the 37201A protects against errors introduced by poor quality data circuits. It even provides immunity to major interruptions in the data link, such as dropouts, line breaks and modem sync loss, and recovers automatically without loss of data.

37201A HP-IB Extender

HEWLETT-PACKARD INTERFACE BUS

Versatile Interconnect System for Instruments and Controllers

Models 37203A, 37203L

- Transparent HP-IB extension up to 1000 metres
- HP-IB transfer rate up to 50 k bytes / s
- Supports all HP-IB functions including pass control and parallel poll

- Electrical isolation plus error detection and correction protect HP-IB from transmission errors
- Transmission over single low-cost coaxial cable or, with option 001, dual optical fiber

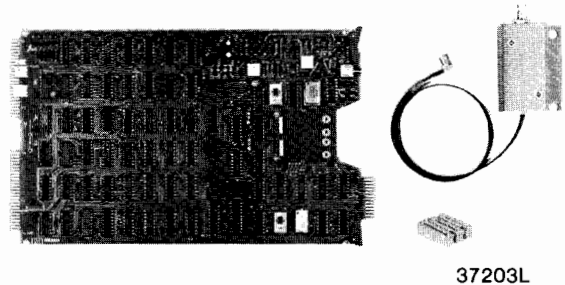
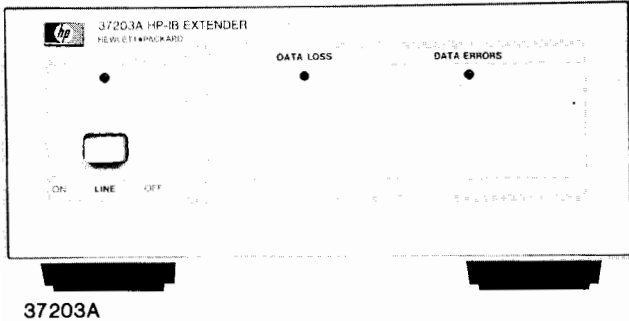

37203A HP-IB Extender

The 37203A HP-IB Extender overcomes the range limitations imposed by the cabling rules of the Interface Bus and provides high-speed, low-cost extension up to 1000 metres.

37203A's are used in pairs: each Extender serialises the normally parallel HP-IB information and transmits it to the other Extender where it is reconverted back to its original format. The transmission medium can be a single low-cost coaxial cable for both directions of transmission or, when Option 001 is fitted, dual optical fiber.

The 37203A is in general compliance with each of the following standards and supports their major capabilities

- IEEE Standard 488-1978
- ANSI Standard MC1.1
- IEC Standard 625-1

37203L HP-IB Extender

The 37203L is a repackaged version of the 37203A on an L-series computer card specifically designed for installation in the HP 2250A Measurement and Control Processor and HP 1000 L-series Computer. It operates in conjunction with a 37203A or another 37203L at the other end of the link. The transmission media and distances are the same as for the 37203A. The 37203L is supplied as a single circuit card together with two cable assemblies. Power is supplied from the 2250A or Computer mainframe. Operating characteristics are identical to those of the 37203A.

Operating Characteristics (37203A/L)

Speed / Range

The table below shows the trade-off between maximum byte transfer rate and distance for coaxial cable and optical fiber.

Table 1. Nominal HP-IB Transfer Rates and Response Times

	Max HP-IB byte transfer rate (kbytes/sec)	Max SRQ propagation delay (μ s)	Max Parallel Poll response time (μ s)
Coaxial Cable			
Short* (at normal speed)	50	14	20
250m (max range at normal speed)	40	18	25
500m (max range at 1/2 speed)	14.2	55	75
1000m (max range at 1/6 speed)	2.75	200	270
Fiber Optics (opt 001)			
Short*	50	14	20
250m	39	20	25
1000m	25	30	40

*For distances <250m, interpolate between Short and 250m.

Parallel Poll Operation

The 37203A supports the Parallel Poll function but because of the absolute transmission delay, a guaranteed response cannot be delivered within 200 ns, as required by IEEE 488. Instead, the response from distant devices is returned as rapidly as possible to the polling controller.

Error Detection and Correction

Data is transmitted across the link in frames. Each frame includes a cyclic redundancy check code which is rechecked when the frame is received. Any transmission errors which are detected cause the frame to be rejected. Data integrity is maintained by automatic retransmission of the rejected data frame. The presence of errors in the received data causes the DATA ERRORS indicator on the 37203A front panel to be illuminated.

Transmission Over Coaxial Cable

The standard serial link between Extenders is a single coaxial cable which is used for transmission in both directions. Coaxial cable was chosen for this link because it is relatively inexpensive, easy to handle, and easy to obtain. The use of Belden type 9248B cable (or equivalent) is recommended.

Transmission Over Optical Fiber

Option 001 of the 37203A/L provides the capability of operation over duplex optical fiber as a user-selectable alternative to coaxial cable. The use of optical fiber removes the metallic path between the Extenders and, therefore, eliminates all risk of electromagnetic pick-up on the link. Option 001 is recommended for use in severe electrical environments or where the use of electrical signaling is not acceptable. A further advantage of optical fiber is that it enables a higher byte transfer rate to be attained for transmission distances greater than 250m than is possible with coaxial cable (see Table 1).

39200 Series Fiber Optic Cables

Operating temperature: -20 to 70°C.

Storage temperature: -40 to 85°C.

Relative humidity: 95% at 70°C (max).

Max. tensile force on cable: 300N.

Max. tensile force on connector/cable: 100N.

Min. bend radius: 7 mm (0.3 in).

Flexing: 50000 cycles (180° bending at min bend radius).

Crush load: 20 kg (44 lb).

Options (37203A / L)

001: Fiber Optic Interface

301: Rack Mount Adaptor (37203A only)

302: Dual Rack Mount Adaptor (37203 only)

Ordering Information

37203A HP-IB Extender

37203L HP-IB Extender



3056DL

Hewlett-Packard's automatic data acquisition and control equipment serves an ever-growing role as the world's industry strives to increase its productivity. More and more industries are discovering that automation is the key to remaining competitive and profitable. This section will outline some of the points that should be considered when evaluating automation solutions.

Industrial automation applications can be organized into three ideal categories: **Test**, **Measurement**, and **Control**.

Test

The approach to industrial automation described as **Test** represents a situation where a product or device is being checked to its design standards. The variables to be measured and the requirements for accuracy and precision are well known. As an example of the **Test** philosophy, consider battery testing. A definite set of variables are measured (output voltage, voltage under load, output current charge capacity, etc.). Expected values and allowable tolerances for all inputs are known in a test application.

Measurement

A measurement approach to industrial automation includes applications that evaluate or research a device, design or phenomenon. Unlike the **Test** approach, the measurement model is not known, in fact the quantities may not be understood. **Measurement** is the gathering of the data to construct a model of the unknown. As an example, scientists are researching ways to maximize food production by optimizing plant watering methods. These scientists might adopt a **Measurement** philosophy by attempting to characterize the response of crops to various watering strategies. Quantities they might need to measure include plant weight, growth, leaf temperature, etc. It is very likely that as they develop a model of how a plant reacts to different watering strategies they will want to measure other things, i.e., they will seek to improve their model.

Control

A **Control** type of application is similar to a **Test** application in that the model or process is well understood. A **Control** system makes

a series of events take place, measures them and takes corrective action. Consider the sequence of events in a metal casting and curing operation. Because the parts may be used in aircraft, careful control and documentation of the process will be needed. For example, the controls on the curing oven will be set according to the particular part being produced. In addition, to comply with the documentation requirements the temperature of the curing oven must be recorded. To insure against costly rework or scrap, the control operation needs to sense other critical events and to take appropriate action.

The three classes of industrial automation described above are ideal and any real world application would probably be a composite of all three. However, they emphasize certain requirements that will help in recognizing what equipment is best suited to fit a specific automation application. The following sections will analyze test, measurement and control applications in regard to instrument and computer features.

Accuracy

High accuracy, wide dynamic range and good resolution are the requirements for measurement applications. In these situations the input signal is frequently small and high accuracy is needed to aid in developing the most accurate model possible. In contrast, in control and production test applications the input is well characterized and therefore the demands of accuracy and resolution may not be as stringent.

Comparison of Analog Measurement Performance

	Sensitivity	Resolution	Accuracy
3421A	1 μ V	1 part in 300,000	.01%
3497A	1 μ V	1 part in 120,000	.007%
3054A/C	100 nV	1 part in 1,200,000	.0032%
6940B	10 μ V	12 bit	.20%
6942A	50 μ V	12 bit	.15%
2250	1.56 μ V	14 bit	.08%

Measurement Speed

Maximizing measurement speed is often a characteristic of test and control applications where throughput and production efficiency are of great concern. As a general rule there is a trade-off between speed and accuracy—the longer something is measured, the more accurately it is measured. Or conversely, the faster an input is measured, the less accurate the measurement.

Comparison of Analog Measurement Speed

	Resolution	Maximum Readings/Second
3421A	1 part in 300,000	4
	1 part in 30,000	23
	1 part in 3,000	38
3497A	1 part in 120,000	50
	1 part in 12,000	200
	1 part in 1,200	300
3054A/C	1 part in 1,200,000	48
	1 part in 120,000	210
	1 part in 12,000	330
	1 part in 2,000	5,000
6940B	12 bit	7 (integrating converter)
	12 bit	20,000
6942A	12 bit	33,000
2250	14 bit	50,000

Control Features

The Hewlett-Packard products considered in this section have capability to sense digital inputs, count pulse trains, close relays and provide programmable voltage and current outputs. Consider each product in regard to your particular application.

Instrument	Digital Input/Interrupt	Actuator Output	Programmable Voltage & Current	Counter Input	Timer	Pulse Train Output
3421A	X	X	—	X	—	—
3497A	X	X	X	X	X	—
3054A/C	X	X	X	X	X	—
6940B	X	X	X	X	X	X
6942A	X	X	X	X	X	X
2250	X	X	X	X	X	X



2250

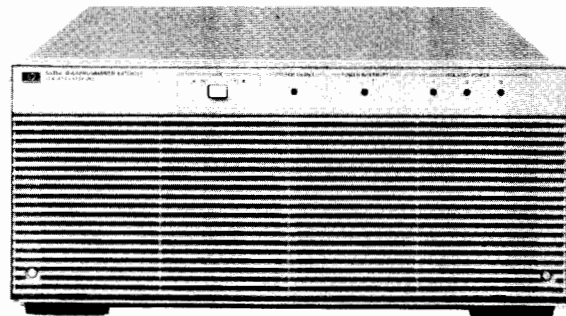

6942A

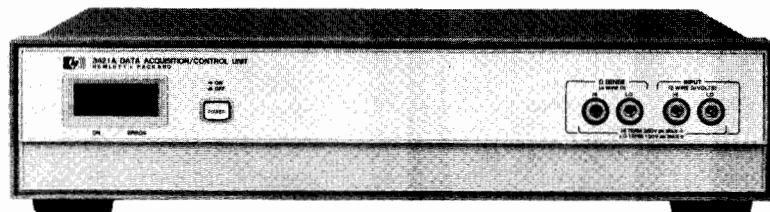

3421A

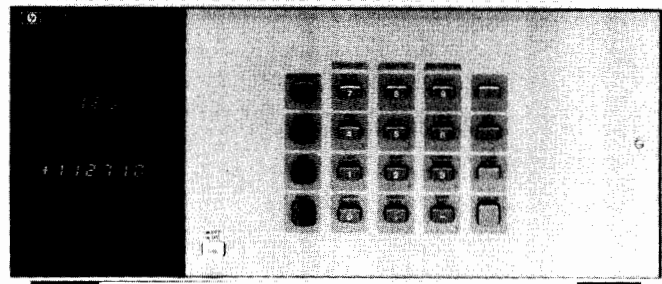

3497A

Instrument Intelligence

Applications differ in how much they will require instruments to do independently of a computer.

Measurement applications are usually closely coupled to the computer and place few demands on the instrument. **Test** and **control** applications may have higher instrument intelligence requirements. In **Test** applications the instrument may operate stand alone from the computer and only report exceptions to the test limits. In **Control** applications it may be desirable for the instrument to operate separately from the computer to protect against computer or I/O link failure. Some products rely on more powerful microprocessors that can operate independently of the main computer. Other products, specifically the 6940 and 6942, rely on card to card cabling to provide additional capability.

	Relative Rating of Standalone Product Intelligence (doesn't include computer)	Reading Storage	Program Storage
3421A	Low	Yes	No
3497A	Low	Yes	No
3054A/C	Low	Yes	No
6940B	Low	No	No
6942A	Moderate	Yes	Yes
2250	High	Yes	Yes

Environment

Consideration of the operating environment is a very important step in choosing a measurement, test or control system. Any application can require that a test, measurement or control system operate in hot, dusty and corrosive environments. In addition, the electrical environment should also be considered in regard to the amount of electrical noise (both common and normal mode) present in the area.

While all Hewlett-Packard instruments are designed to operate in moderately harsh environments, the 2250 Measurement and Control Processor has been specially designed to tolerate more harsh industrial conditions. This includes elevated temperatures and high common mode voltages. Refer to

the 2250 literature for additional information.

Integrated Systems

In addition to providing the individual instruments and computers needed for automation, Hewlett-Packard also provides dedicated SYSTEMS that combine instruments, computers, and software with rack mounting and integration. Systems range from the 3054DL Data Logger which provides an easy to use software package for the first time user to the 3054A/C systems which provide utility subprograms that the customer can use to build his own program. Systems have the advantage of providing a more complete solution and allowing the user to concentrate more on his automation task.

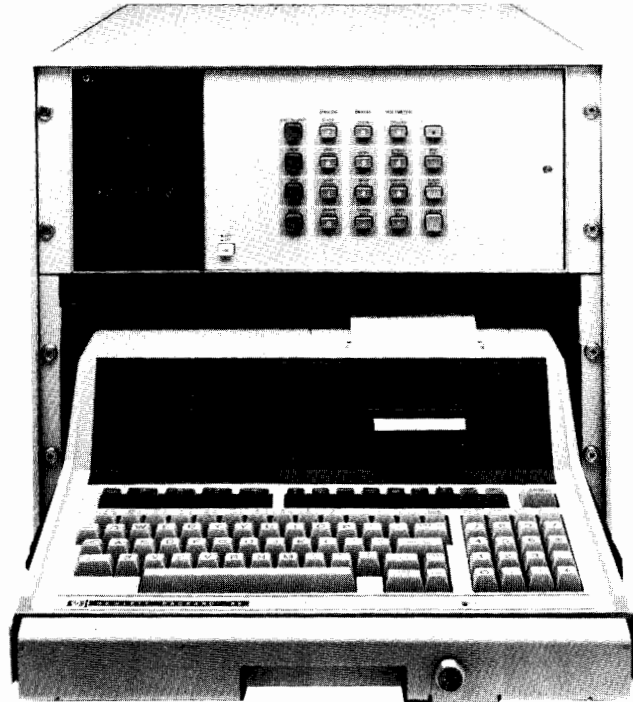

3054DL

Base Instrument	System
3421A	3056DL Data Logger
3497A	3054DL Data Logger
3497A/3456A/3437A	3054C Automatic Data Acquisition/Control System
3497A/3456A/3437A	3054A Automatic Data Acquisition/Control System
6940B	Software Available
6942A	Software Available
2250	Software and Integration Available

Customized system integration is also available using the ATS/1000 system integration service. This service combines customer specified measurement and control equipment with HP 1000 computers. Integration ranges from simple racking and cabling to installation of the system and writing of software.

For further information on these products, please refer to the following catalog pages. Separate technical brochures are also available on each product.

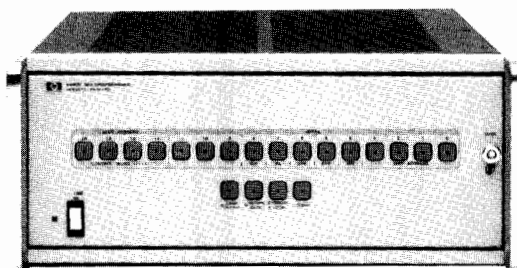

6940B

Automation Hardware	Catalog Page	Technical Brochure #
3421A	43	5953-6912
3497A	52	5952-8886
3054A	48	5952-8897
3054C	51	5952-8865
3054DL	50	5952-8862
3056DL	45	5953-6912
6940B	62	5952-4025
6942A	62	5952-4034
2250	56	5953-4288



- Up to 60 channels
- Graphics
- Data stored on tape
- Menu and subroutine software

- Adaptive data logging
- User definable functions
- Choose from 18 separate functions

User Definable Functions

There are no less than 17 separate functions to choose from:

- DCV •ACV •Digital Read •Actuate
- 2-Wire Ohms •4-Wire Ohms •Frequency •4-20 mA
- Thermocouples: J•K T•E R•S
- 2-Wire RTD •4-Wire RTD •2.2K Thermistor

Each function is selected simply by pressing the appropriate key on the HP 85F computer.

When the 17 available functions are not adequate, you can generate your own linearization equation: $mX+B$, a 5th order polynomial, or even a BASIC subroutine that you write yourself.

Adaptive Data Logging

When a specified channel exceeds its measurement limits, you can instruct the system to print to display a warning, or jump to a completely different measurement routine. For instance, you can scan slowly while the process you are monitoring is stable, and then adapt the scanning rate when an out-of-limit condition occurs. This "adaptive scanning" philosophy makes efficient use of data storage space and computer time.

Ordering Information

Options

Input Assemblies

- 020:** 10 Channel Multiplexer Assembly, connector block
- 040:** Breadboard Assembly, connector block
- 050:** Digital Assembly, connector block

Power Line Options

- 315-346:** Options for 100 V/50 Hz through 240 V/60 Hz

Systems Options

- 201***: add HP-IB Interface to the 3421A (allows the use of EITHER HP-IB or HP-IL)
- 202***: two 3421A's (both HP-IL) for up to 60 channel capacity
- 203***: two 3421A's (both HP-IB) for up to 60 channel capacity
- 400:** delete 16 in. cabinet, locking drawer
- 541:** add 41CV, 44468A Data Acquisition Pac for 41CV, 82160A HP-IL Module and 82182A Time Module
- 561:** add 82161A HP-IL Digital Cassette Drive
- 562:** add 82162A HP-IL Printer/Plotter
- 910:** extra set of 3056DL manuals, pre-recorded tape cartridge

Computer

Order either the 85F or the 85F Option 006. To operate the 3056DL, you need all three items—the 85, the extra 16K memory module and the Advanced Programming ROM

85F: Personal computer with graphics CRTs and printer, tape drive, 16K memory, HP-IB Interface Card (82937A), I/O ROM (00085-15003) and drawer (82936A)

Opt 006: same as 85F, but with HP-IL Interface

82903A: additional 16K Memory Module

00085-15005: advanced Programming ROM

3056DL Data Logger: includes one 3421A Data Acquisition/Control Unit with 5½ digit DVM, VDC, VAC, Ω, Counter, 30-reading storage, HP-IL Interface, sliding drawer and cabinet, software levels 1 and 2. Computer is ordered separately.

* Select no more than one

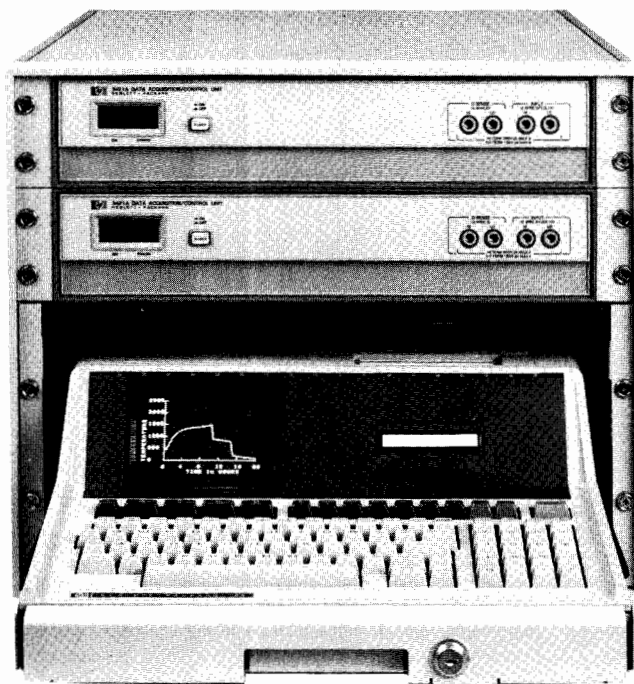

Description

The 3056DL Data Logger merges the measurement capabilities of up to two 3421A Data Acquisition/Control Units with the programming versatility of the HP 85F computer. It comes in an attractive locking cabinet with two dedicated software packages and all necessary cables.

The Hardware

Each 3421A Data Acquisition/Control Unit used in the 3056DL Data Logger has the accuracy and resolution for critical applications. The basic accuracy is .01%, with a 5½ digit A/D Converter, a sensitivity of one microvolt, signal conditioning for thermocouples, DCV, ACV, Ohms, and Frequency. Each has a scanning capacity of up to 30 channels as well as 30-reading storage buffer. The 3421A assures you of precise transducer measurements at a surprisingly low price.

The HP 85F Personal Computer communicates with the 3421A via either HP-IL or HP-IB. The 85F has the data logging features you need all in a single integrated package: keyboard, magnetic tape drive, graphics printer and CRT.

The Software

Two levels of software come with each 3056DL Data Logger. The 3056DL Menu Software is ideal for the first-time user, yet powerful enough for an expert.

For the BASIC programmer, there are measurement subroutines in the 3056DL software. Integrate these subroutines into your own programming material to get the optimum speed and efficiency from the data logger.

DATA ACQUISITION, CONTROL & TEST

Data Acquisition/Control Unit

Model 3421A

- Up to 30 differential channels, 56 single-ended channels
- Electronic calibration for repeatable answers
- Built-in 5½ digit A/D converter with 1 μV sensitivity
- HP-IL (standard) and HP-IB (optional) with rear panel switch
- Optional 12 volt battery power
- "Sleep mode" for extended battery life in remote locations
- Front terminals for convenient DCV, ACV, 2- & 4-wire ohms, frequency and temperature
- Display shows channels closed, digital states and self-test conditions

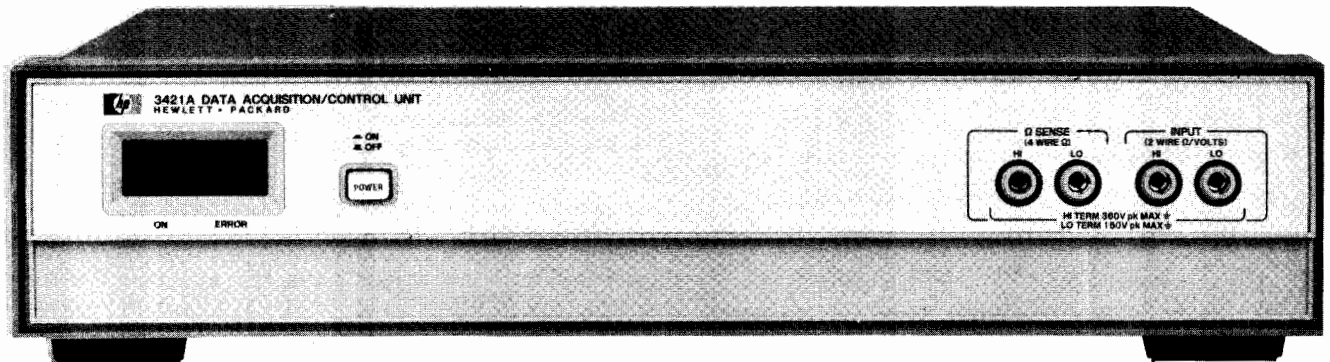

Description

The HP 3421A Data Acquisition/Control Unit is the system that beats the high cost of data logging. Use it for that small data acquisition project with the assurance that it will quickly pay its own way.

The 3421A scans up to 30 channels, measuring DCV, ACV, 2- and 4-wire Ohms, Frequency, and Temperature. It also reads and writes digital information and stores up to 30 analog readings. The standard 3421A comes with an HP-IL interface for battery-powered flexibility or HP-IB for more computational power.

Up to three of the following assemblies may be added to the 3421A mainframe:

- 10-Channel analog multiplexer/actuator assembly with thermocouple compensation
- 8-bit input/8 bit output digital assembly
- Breadboard assembly for custom circuitry

Measurement Integrity

With its 5½, 4½, 3½ digit A/D converter, the 3421A can resolve 1 μV out of 300 mV to monitor thermocouples, strain gage bridges and other low-level transducers. Or it can read higher level signals by auto-ranging up to 300 volts dc.

System Versatility

Each 3421A can scan up to 30 differential channels or 56 single-ended channels of analog information. The 3421A is battery-powered, with latching relays that will not change state when the ac line power is removed. Battery power gives the 3421A its own uninterrupted power supply.

All functions are remotely programmable via either HP-IL or HP-IB. Use HP-IL with the 41 CV handheld calculator as a self-contained battery-powered data logger, or use HP-IB with the HP 85F Personal Computer for more programming performance.

Special 41C/CV ROM

To make the 3421A more convenient for benchtop or field use, a Data Acquisition Pac (HP 44468A) is available for the HP 41C/CV handheld computers. Using the HP-IL I/O, this Pac gives the HP 3421A an operational front panel from the computer's keyboard using "soft" keys defined by a keyboard overlay and special ROM. It also includes a data logger program complete with special keyboard overlay to allow the user to enter beginning-and-ending scan se-

quence, to define the functions to be measured, to automatically compensate for the most common types of thermocouples and to simplify storage of data. Prompting is done on the HP 41 handheld computer's LCD display. The HP 41C/CV can be equipped with an HP 82182A Time Module which allows the operator to specify at what time scanning sequences are to take place and at what interval measurements are to be made.

The 41CV System

Combine the 41CV, the 3421A, the 82161A Digital Tape Drive, and the 82162A Printer/Plotter to make a portable low-cost data logger. The 44468A Data Acquisition Pac makes programming easy. It contains a 41CV Control ROM for the 3421A as well as two special 41CV keyboards. Each keyboard is dedicated to providing fast, simple function programming with the 41CV.

The 85F System (The 3056DL)

The 3421A can also be combined with the 85F Personal Computer for even easier and more powerful data logging. Dedicated software enhances the system with Menu programming, Subroutine programming, instrument panel emulation and graphic analysis. It makes data logging as easy as answering a few questions on the CRT display.





Use thermocouples with the HP 3421A to measure the temperature of a bridge section to tell the best time to resurface the roadbed. Or use the dc voltage function to monitor the galvanic effect that causes steel reinforcing rods to corrode inside the concrete.

The HP 41CV handheld calculator can turn on the 3421A Data Acquisition/Control Unit, trigger it to scan a list of 30 channels, instruct the digital cassette to store all 30 readings on tape and then power down the entire system until the next time interval passes.

The 3421A is not limited to portable applications. It is equally useful in laboratory situations, where its 0.01% accuracy, 1 microvolt sensitivity and 5½ digit resolution assure you of reliable answers.

Digital inputs, actuator outputs and a breadboard assembly give the laboratory designer a great deal of instrument flexibility while HP-IB compatibility adds the option of a more powerful instrument controller.



3421A Mainframe Specifications

The 3421A mainframe comes with:

- A 5½, 4½, and 3½ digit integrating A/D converter
- Thermocouple compensation
- Type T thermocouple linearization built in
- HP-IL
- 30-reading storage buffer
- LCD 30 channel display with power and error indicators
- Electronic calibration
- Rechargeable battery
- High level command set

All specifications apply for relative humidity less than 85% at 30 degrees C.

DC Voltage

Ranges: 300 mV, 3 V, 30 V, 300 V, Autorange

Basic accuracy: ±(.009% Reading + 3 counts); 5½ digits

Reading rates: 2 to 35 readings/second

Resistance

Ranges: 300 Ω, 3 kΩ, 30 kΩ, 300 kΩ, 3 MΩ, 30 MΩ; Autorange

Basic accuracy: ±(.012% Reading + 3 counts); 5½ digits

Reading rates: 2 to 35 readings/second

AC Voltage

Ranges: 3 V, 30 V, (300 V with 44469A divider)

Converter type: averaging

Resolution: 3½ or 4½ digits

Basic accuracy: 4½ digits: ±(0.5% reading + 60 counts), 45 Hz to 500 Hz; ±(1% reading + 60 counts), 30 Hz to 1 kHz

Counter

The counter is part of the mainframe circuit, and is multiplexed through the channel relays.

Resolution: 65,535 counts

Frequency: 1 Hz to 10 kHz

Modes: frequency, Totalize

Thermocouple Thermometer

Type T thermocouple linearization is built in. For other thermocouple types, the reference junction temperature is available on each multiplexer assembly.

Option 020 10-Channel Multiplexer Assembly

Each multiplexer assembly has 10 relays. They can be configured as 10 multiplexers, 9 multiplexers plus one actuator, or 8 multiplexers plus two actuators. The actuators are capable of switching 252 VAC. One 3421A mainframe can accommodate up to 3 assemblies.

Option 040 Breadboard Assembly

The breadboard assembly is convenient for constructing custom circuitry. It comes complete with a manual describing the circuit that enables the 3421A to communicate directly with an 8-bit microprocessor.

Option 050 Digital I/O Assembly

Option 050 has 8 isolated input lines and 8 isolated output lines for both monitoring and controlling external digital devices.

Option 212 12 Volt Power Assembly

The 12 volt assembly provides the necessary isolation and voltage regulation to allow use of a 12 volt automotive battery as a power supply. This option also provides connectors to charge the 41CV controller, the 82161A Cassette Drive and the 82162A Printer/Plotter. The system will operate in an automotive environment such as from a cigarette lighter with the engine running or off. Option 212 cannot be ordered if Option 201 has been specified.

Ordering Information

Options

Input and I/O Assemblies

020: Ten Channel Multiplexer Assembly with thermocouple compensation, connector block.

040: Breadboard Assembly with connector block

050: 8 bit in, 8 bit out Digital I/O Assembly with connector block

201: add HP-IB interface. Allows use of EITHER an HP-IB or HP-IL controller

212: add 12 volt power assembly. Cannot be added if opt 201 is specified

3421A/41CV System Options

541: Add 41CV for 3421A control. This option includes the HP 41CV handheld calculator, 44468A Data Acquisition Pac with 3421A/41CV Control ROM, 82160A HP-IL Interface Module for 41CV, and an 82182A Time Module

561: Add 82161A Digital Cassette Drive (HP-IL)

562: Add 82162A Printer/Plotter (HP-IL)

Power and Frequency Options

315-346: Line Power options from 100 V/50 Hz-240 V/60 Hz

Rack Mount and Manual Options

401: Side Handle Kit

907: Front Handle Kit

908: Rack Mount Kit

909: Rack Mount with Handle

910: Extra Manuals

Field Installation Kits

44462A: 10-Channel Multiplexer Assembly with thermocouple compensation, connector block

44463A: extra connector block for above

44464A: Breadboard Assembly with connector block

44465A: 8 bit in, 8 bit out digital I/O assembly with connector block

44466A: Extra connector block for digital or breadboard assembly

44468A: Data Acquisition Pac for 41CV

44469A: Six 10:1 dividers for measuring 300 VAC (one pair comes standard with each option 020)

Accessories

34118A: Test Lead Kit

3421A Data Acquisition/Control Unit

DATA ACQUISITION, CONTROL & TEST

Automatic Data Acquisition/Control System
Model 3054A

- Improve productivity in research and manufacturing
- Low cost data acquisition
- Precision transducer measurements and analysis
- 1000 analog channels and 1360 digital points
- Control functions for closed-loop applications

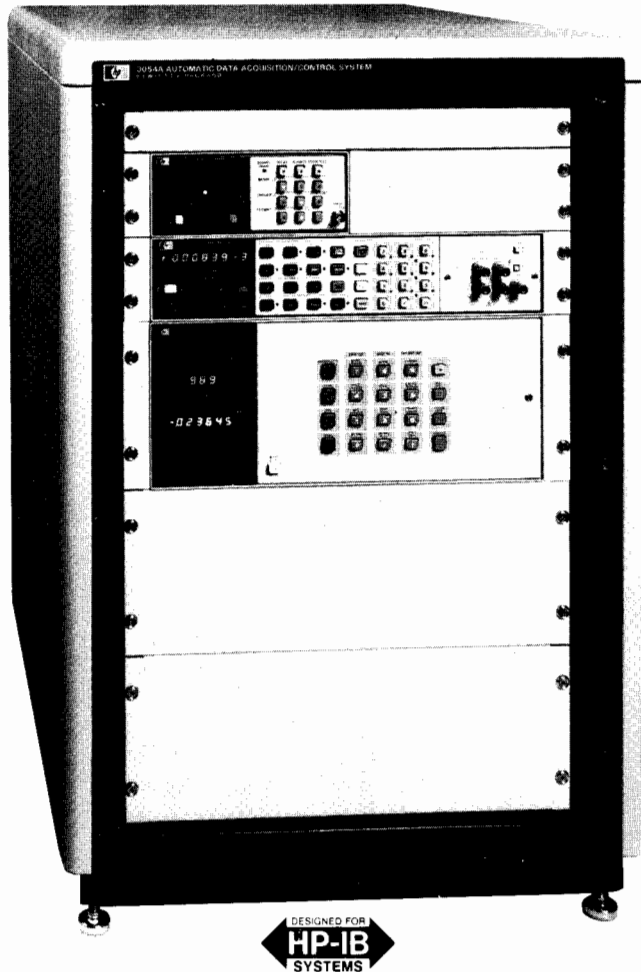

Description

The 3054A is a computer-based automatic data acquisition and control system. The 3054A combines speed, precision and a variety of control functions with full computation and analysis capabilities. The 3054A offers flexibility, convenience, and performance to solve many data acquisition applications.

The system has the flexibility to make a wide variety of measurements, including outputs of thermocouples, strain gages, RTD's, flow meters, and other transducers. The 3054A also has digital inputs and outputs, voltage and current D/A converters for precision closed-loop control.

The 3054A offers the convenience of using instrumentation that is designed as a system. To help the user get started fast, the measuring system is rack-mounted and pre-tested. System specifications represent the summation of all instrument errors. An Introductory User's Guide is part of the system documentation package which enables the user to quickly learn how to use the system for his or her application.

The 3054A system performs by combining speed, accuracy and computational power. Measurement rates from 4800 readings/second to 48 readings/second are possible with resolutions from 3½ digits to 6½ digits. DC measurements of low level transducers can be made with 100 nanovolt resolution with greater than 150 dB of noise rejection. An HP desktop computer or mini-computer will automate the system, store data, linearize transducers, and provide computation and analysis.

The 3054A system is a powerful yet economic system for transducer measurements.

System Configuration

The 3054A system includes:

The 3497A Data Acquisition/Control Unit is the instrument that provides the analog multiplexing, digital monitoring, and control functions using plug-in assemblies. The 20 Channel Reed Relay Assembly provides low level guarded switching with $<2 \mu\text{V}$ of thermal offset. An isothermal connector is provided as an option to this assembly for thermocouple compensation. An FET multiplexer assembly provides fast scanning and high reliability. Digital input and output assemblies are available for monitoring and control. And you get specialized measurement and control using the Reciprocal Counter Assembly and the programmable D/A Converter Assemblies. Up to five of these optional plug-in assemblies can be contained in the 3497A mainframe. Expansion to more than five assemblies is provided by the 3498A Extender. Each 3498A can hold ten more assemblies. A total of thirteen extenders can be supported by one 3497A mainframe, giving a maximum of 1000 analog channels and 1360 digital channels.

System timing is accomplished through the non-volatile real time clock in the 3497A.

The optional DVM assembly for the 3497A has $1 \mu\text{V}$ sensitivity, 5½ digit resolution, integration, and guarding—capability previously available only on stand-alone system DVMs. (Refer to page 52.)

The 3456A Digital Voltmeter is a 3½ to 6½ digit integrating voltmeter with high accuracy, 100 nanovolt sensitivity, and speed to 330 readings/second. Its DC and True RMS AC voltage and resistance measurement capability reduce the amount of signal conditioning necessary. The 3456A can detect 100 nanovolt changes in 100 mV signals at speeds of 48 readings/second. This capability is necessary for measuring thermocouples with the 3054A system to better than 0.01°C resolution. Common mode rejection of 140 dB makes the 3054A system particularly suited for repeatable low level measurements in the presence of noise.

The built-in memory of the 3456A can store both readings and sequences of measurement commands. The 3456A can store internally up to 350 readings or up to 1400 ASCII programming characters or combinations of both readings and programming characters. Use it with Option 030 FET Multiplexer Assembly to scan sequential channels at up to 4800 channels per second.

The **3437A System Voltmeter** is a high speed 3½ digit DC voltmeter which provides precisely timed sample and hold readings. Use it to analyze repetitive signals up to 1 MHz or transients down to 1 msec. in a fraction of the time required by conventional means. Use it with Option 030 Fet Multiplexer Assembly to scan sequential channels at up to 4800 channels per second.

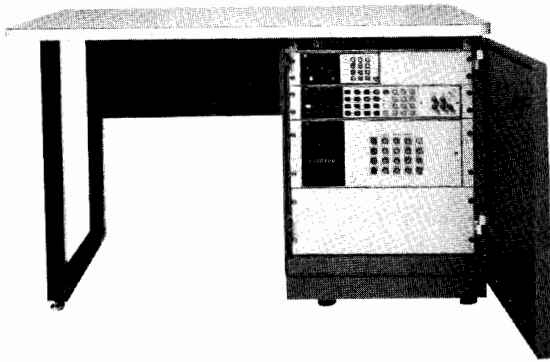

The variety of cabinet options with the 3054A can be configured to fit a wide range of applications.

Power and Performance in Desktop Computers

A choice of computers with the 3054A provides a wide range of capability and performance for automating data acquisition applications. The desktop computers supported with the 3054A are the HP 85F, Series 200, 9825B and 9845T. The computers automate the system by controlling the instruments and gathering the data over HP-IB. All of these computers offer easy interaction to greatly simplify the writing and editing of programs. The friendly languages of the computers and the 3054A software package make it easy to get started. The presentation of data is very versatile when using a computer and external peripherals. Transducer data can be converted to engineering units, statistical analyses of the data can be performed and graphical representations of the data can be produced. The individual capabilities of each computer such as speed, memory size, and output devices should be considered for the different data acquisition applications.

Software and Documentation

The system software is an integral part of the 3054A Automatic Data Acquisition/Control System. Specially written software and documentation packages are supplied for each of the computers. This complete software package greatly simplifies programming and enables the user to get started fast.

The complete software and documentation package supplied with the 3054A includes:

- operational verification programs
- system sub-programming routines
- typical application programs

The system verification/diagnostic programs can be used to verify that the system is in operating condition at the time of installation. The programming of the 3054A is most effectively accomplished by combining the system sub-program with other system operations. Sample application programs are also provided for assistance in developing functional software.

Racks and Cabinets

Other cabinets may be chosen besides the standard 30" rack for the 3054A. A 16" case is offered as a compact and portable package for the 3054A. A desk provides rack space for the instrument and a table top for software development. The 56" cabinet provides space for additional equipment and future expansion.

For more information on the 3054A, contact the local HP Field Engineer or nearest HP Sales Office.

System Options

Input Assemblies for the 3497A

- 010:** 20 Channel, Low Thermal Relay Multiplexer Assembly
- 020:** Relay Multiplexer Assembly with Thermocouple Compensation
- 030:** 20 Channel FET Multiplexer Assembly
- 050:** 16 Channel, Isolated, Digital Input/Interrupt Assembly
- 060:** Reciprocal Counter Assembly
- 070:** 10 Channel, 120Ω Strain Gage/Bridge Assembly
- 071:** 10 Channel, 350Ω Strain Gage/Bridge Assembly

Output Assemblies for the 3497A

- 110:** 16 Channel Actuator/Digital Output Assembly
- 115:** 8 Channel High Voltage Actuator
- 120:** ±10V Dual D/A Converter Assembly
- 130:** 0 to 20 mA or 4 to 20 mA Dual D/A Converter Assembly
- 140:** Breadboard card for custom designs
- 230:** U.S. Clock Format for the 3497A (Month:Day:Hours:Min:Sec)
- 231:** European Clock Format for the 3497A (Day:Month:Hours:Min:Sec)
- 260:** Delete Keyboard and Display on 3497A
- 261:** Delete 3437A SVM and HP-IB cable
- 262:** Delete 3456A DVM and HP-IB cable
- 280:** Add 5½ digit DVM and current source for the 3497A. NOTE: Only one DVM may be deleted from system, unless optional 3497A DVM assembly is added.
- 298:** Add 3498A Extender and connecting cables

Cabinet Options

- 400:** Delete 30" cabinet; rack-mounting hardware supplied
- 416:** Add 16" combining case with power strip; delete 30" cabinet
- 456:** Add 56" cabinet with fan and power strip; delete 30" cabinet
- 490:** Add 44530A systems desk with fan, power strip, and 23" rack space; delete 30" cabinet
- 496:** Add locking drawer, 8" high, for 85A
- 498:** Add locking drawer, 18" high

Software and Documentation Options

- 841:** Complete 3054A System Documentation—85A
- 842:** Complete 3054A System Documentation—9825B
- 844:** Complete 3054A System Documentation—9845T
- 800:** Complete 3054A System Documentation—Series 200 (BASIC) on 3½" flexible disc
- 801:** Complete 3054A System Documentation—Series 200 (BASIC) on 5½" flexible disc
- 804:** Complete 3054A System Documentation—9826A (HPL)

Basic 3054A System



DATA ACQUISITION, CONTROL & TEST

Data Loggers Model 3054DL

- 5½ Digit measurement
- Graphics

- Data analysis
- Graduated software

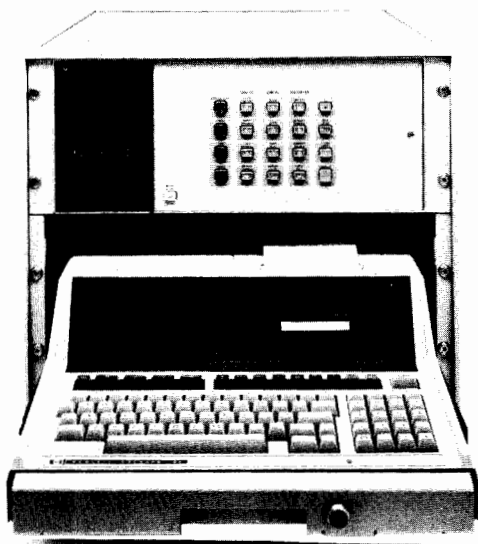

Description

The 3054DL consists of a precise measurement unit housed inside an attractive locking cabinet. When you add the computational capability of the 85F scientific computer, the combination becomes more than just a data logger—it becomes a complete scientific measurement station with data and program storage, graphics and excellent measurement performance.

The measurement unit contains a 5½ digit digital voltmeter with a dc current source for ohms measurements as well as a 5-slot mainframe for optional plug-in assemblies. Each slot accepts either a counter, a low-thermal multiplexer, a thermocouple multiplexer, a digital input card or a digital output (alarm relay) card. Advanced noise-rejection techniques such as Multi-Slope Integration and Tree Switching compliment the 1 microvolt sensitivity of the voltmeter.

The 85F computer is not only a system controller, it is a full function BASIC language scientific computer with data analysis capabilities, graphics CRT and printer, and a built-in tape cartridge for both data and program storage.

Temperature measurements, whether made with thermocouples, RTD's or thermistors, are all specified in terms of total system accuracy. The thermocouple reference junction is located on the connector block and is read automatically via the data logger software.

Resistance can be measured in a 4-wire configuration to eliminate the effects of lead wire resistance.

The reciprocal counter accepts logic-level inputs and can operate in either a period measurement mode or a totalize mode.

Digital inputs and digital (alarm relay) outputs are available for monitoring switch positions and controlling external devices.

Graduated software

The program, or "software" that instructs the measurement unit is stored on a magnetic tape cartridge in the 85F computer. This software flexibility allows you to choose any one of the three programming methods that fits your need best:

- Level 1: Menu entry . . . no programming language required
- Level 2: Line entry . . . no computer language required . . . just enter data logger information
- Level 3: Subroutine . . . enter a short BASIC program that uses prewritten subprograms.

Graphic presentation is the key to understanding the data. From the graphic display to the program flexibility to the precise measurement capability, the 3054DL is the complete data logger.

3054DL Specifications

The following specifications include all contact resistances, contact voltages and DVM errors. Accuracy specifications apply when the 3054DL is in an ambient environment of 23°C ± 5°, <85% R.H. Temperature coefficients are applied when the ambient temperature is 0 to 18°C or 28 to 50°C.

DC voltmeter (use option 010 or 020)

Ranging: auto or fixed range

A/D technique: integrating

Maximum input voltage: hi to lo: ±120 V peak

Lo to guard: ±170 V peak

Any terminal to chassis: ±170 V peak

Range	Maximum Reading	Resolution	Accuracy (90 days) (%Rdg.+Counts)	Temperature Coefficient (%Rdg.+Counts)/°C	Z _{in}
.1 V	.119999	1 μV	.007 + 5	.00025 + .15	>10 ¹⁰
1 V	1.19999	10 μV	.006 + 2	.0002 + .02	>10 ¹⁰
10 V	11.9999	100 μV	.006 + 1	.0002 + .01	>10 ¹⁰
100 V	119.999	1 mV	.006 + 1	.00025 + .03	10 MΩ ±0.5%

For >90 days, add 10 ppm/month to accuracy

Normal mode rejection: 60 dB (50 or 60 Hz ± .1%)

Effective common mode rejection

AC: 150 dB (50 or 60 Hz ± .1%)

DC: 104 dB (100 channels)

Ohmmeter (use option 010 or 020)

Type: 2-wire or 4-wire

Current source: floating

Range	Maximum Reading	1 Count Resolution	Current Through Unknown	Accuracy (90 days) (%Rdg.+Counts)	Temperature Coefficient (%Rdg.+Counts)/°C
100 Ω	119.999	1 mΩ	1 mA	.032 + 5	.0028 + .15
1 kΩ	1.19999	10 mΩ	100 μA	.032 + 5	.0028 + .15
10 kΩ	11.9999	100 mΩ	10 μA	.032 + 5	.0028 + .15
100 kΩ	119.999	1 Ω	10 μA	.031 + 2	.0027 + .02

For >90 days, add 20 ppm/month to basic accuracy

Options

Option # (choose up to 5 total option cards—3054DL capacity is 5 slots)

010: 20 channel guarded input relay card

020: 19 channel guarded input relay card with thermocouple compensation. Measures JKERT thermocouples or dc volts

050: 16 channel optically isolated digital input

060: Frequency counter, totalizer

110: 16 channel digital output actuator relay card

115: 8 channel high voltage actuator

230: Clock format: Mo:Day: Hr:Min:Sec

231: Clock format: Day:Mo: Hr:Min:Sec

260: Delete scanner display and controls

400: Delete locking cabinet with sliding drawer

841: Add Level 3 software for custom data acquisition programs

910: Extra set of Level 1 & 2 software (one set comes with 3054DL at no charge)

Computer (order both items to complete the 3054DL)

85F: Computer with CRT, printer, keyboard, graphics, magnetic tape drive, 82937A HP-IB I/O card, 00085-15003 I/O ROM, 82936A ROM Drawer

82903A: 16K Memory Module

3054DL: Includes 5½ digit DVM, current source, real time clock, HP-IB interface, sliding drawer and cabinet, software Levels 1 & 2, and pre-initialized data tape

- Precise measurement and analysis
- Execute multiple programs simultaneously
- Communicate to other computers in a distributed network

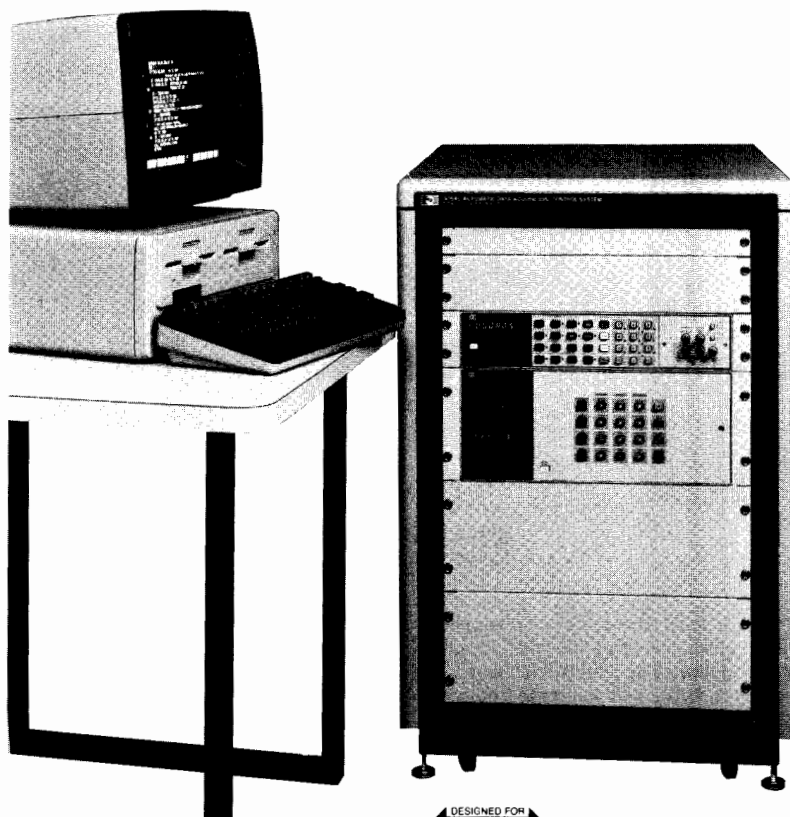

Description

The 3054C Automatic Data Acquisition/Control System combines precise instrumentation with the power and versatility of HP 1000 computers. The 3054C is similar to the 3054A system except that the 3054C supports software compatible with the HP 1000 series of computers. The 1000 series of computers give you increased analysis capabilities and can be used to create multitasking, distributed, data acquisition and control networks. Distributed systems allow you to control instruments with one computer while another computer in the network analyzes or processes the data. The multitasking capability of the HP 1000 allows any computer in the network to simultaneously control instruments with one program while another program performs other, possibly unrelated, tasks.

Instrumentation

The 3054C consists of a 3497A Data Acquisition/Control Unit and a 3456A Digital Voltmeter. The 3497A is a card cage instrument that can be custom configured to meet your needs. Assemblies are available for A/D conversion, multiplexing, strain gage/bridge completion, digital inputs/interrupts, counting, actuator outputs, and voltage and current D/A outputs. The 3456A is a very precise voltmeter and has the resolution and noise rejection required for measuring low levels in a noisy system environment.

Computers

The 3054C software package is compatible with the HP 1000A, L, E, and F series of computers. These computers allow you to configure or expand your system as needed. The L series of computers offers the lowest cost solution for controlling the 3054C. The HP 1000 A series offers significantly more computing power at slightly more cost. The HP 1000 E and F series provides more versatility and the easiest program development. The 1000 A, E, and F series computers are recommended as host computers in a distributed system.

Software

The 3054C software package consists of over 35 subroutines that can be used as building blocks to create a useful measurement program. The subroutines allow the user to write sophisticated programs without knowing instrument programming codes. Included in the 3054C software package are linearization programs for most thermocouples, 120 and 350 Ohm strain gages, thermistors and RTD's. The routines include error trapping to locate and identify system problems.

System Configuration

The 3054C consists of the following. The computer, other computer peripherals and computer operating systems are ordered separately.

3054C

Instruments

- 3497A Data Acquisition/Control Unit
- 3456A Digital Voltmeter

Software and Documentation

3054C Software package consisting of measurement, conversion, utility and HELP routines.

Rack/Integration

30" Rack (shown) is standard. Other racks are available. Integration includes HP-IB cables, instrument connecting cables and test assemblies.

Verification/Installation

The 3054C is installed and tested with the HP 1000 computer at the customer's site.

Ordering Information

**Basic 3054C Automatic Data Acquisition/
Control System**



Data Acquisition/Control Unit Model 3497A

- Relay multiplexing
- DVM
- FET multiplexer — new
- Real time clock
- Bridge completion
- Digital inputs/outputs
- Counter
- Programmable D/A's
- Optional RS 232C interface

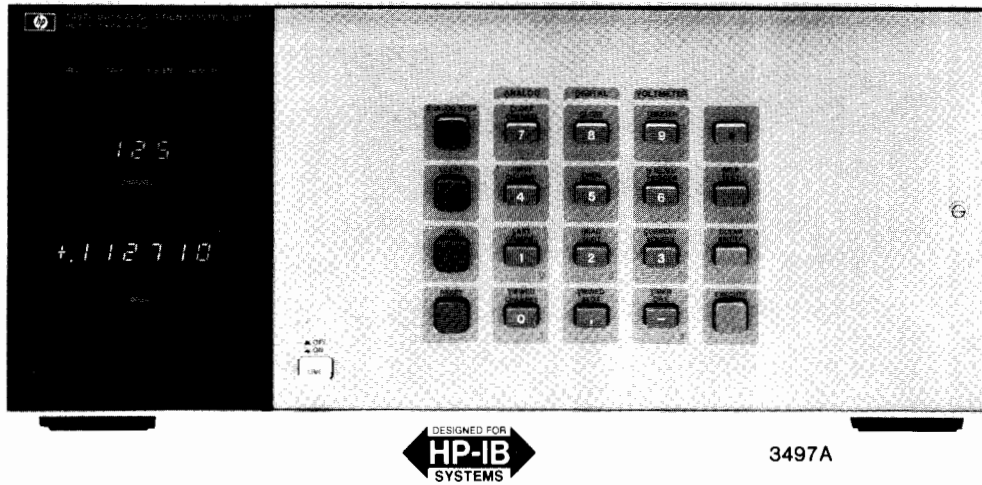

3497A

Description

The 3497A Data Acquisition/Control Unit combines the capabilities of several instruments and is a basic building block of an automatic data acquisition and control system. The 3497A will be used in an HP-IB automated system and can be viewed as a precision measurement and control computer peripheral.

The 3497A has been designed to be a very versatile and very powerful instrument. A basic 3497A consists of a mainframe that includes a front panel keyboard and display, a non-volatile real time clock, and an HP-IB interface. Available as an option is a 5½ digit integrating digital voltmeter and current source that occupies a dedicated slot in the 3497A chassis. Capability is added to the 3497A by using any combination of plug-in assemblies. Available plug-in assemblies are:

- Relay Multiplexers with or without thermocouple compensation
- FET Multiplexer
- Digital Input/Interrupt
- Counters
- Strain gage/bridge completion
- Actuators
- Programmable voltage and current D/A's
- Breadboard Assembly

Up to 5 assemblies can be added to a 3497A and the 3498A Extender chassis can hold up to 10 more plug-in assemblies.

High Performance

The 3497A DVM can resolve 1 microvolt signals and is ideal for the precise measurement of the outputs of thermocouples, strain gauges and other transducers. Included on the DVM is a programmable current source that allows four terminal resistance measurements. The multiplexer assemblies switch 3 wires (Hi, Lo, and Guard) and add less than 2 microvolts of thermal offset to the measured signal.

Flexible Hardware Configuration

The 3497A card cage can hold 5 of any combination of the plug-in assemblies. This allows the multiplexing of up to 100 3-wire inputs to the DVM in a single 3497A or a single 3497A might contain 60 multiplexer channels, 16 digital inputs, 16 actuator outputs, and a DVM. By using the 3498A Extender, up to 1000 analog channels and 1360 digital channels can be controlled, all at a single bus address.

Ease of Use

The 3497A keyboard and display make the 3497A very easy to use and makes debugging of a 3497A based system easy. The calibration adjustments for the 3497A DVM are located behind a hinged front

panel; this allows complete calibration of the DVM without removing it from the test rack. Connections to all of the 3497A assemblies are made using screw terminals, therefore eliminating the need for soldering.

Automatic Data Acquisition and Control Systems

The 3497A is an integral part of the 3054A/C Automatic Data Acquisition and Control Systems. The 3054A consists of a 3456A Digital Voltmeter for high accuracy measurements, a 3437A Systems Voltmeter for high speed measurements and a 3497A for multiplexing, digital I/O and control. The 3054A includes software compatible with the HP 85, 9825, 9835 or 9845 and Series 200 computers. The 3054C is similar to the 3054A but it does not include the 3437A and the software is compatible with the HP 1000 series of computers. The 3497A is also a part of the 3054 DL data logger.

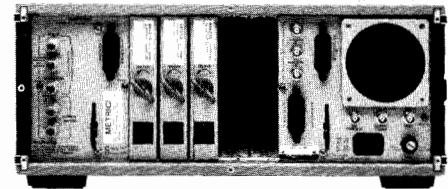

Real Time Clock

The 3497A mainframe includes a quartz referenced non-volatile real time clock. In addition to providing timing data, the clock can measure elapsed time, interrupt at a pre-settable time, and output a programmable pulse train.

Clock Format

Month:Day:Hours:Minutes:Seconds (U.S. Format)

Day:Month:Hours:Minutes:Seconds (European Format)

Modes	Max. Time	Resolution	Accuracy
Real Time Mode:	1 year	1 second	±(.005% of time + .1 s)
Elapsed Time Mode:	10 ⁶ seconds	1 second	±(.005% of time + .1 s)
Time Alarm Mode:	24 hours	1 second	±(.005% of time + .1 s)
Time Interval Mode:	24 hours	1 second	±(.005% of time + .1 s)
Timer Output Mode:	1 second	100 μs	±.02% of time

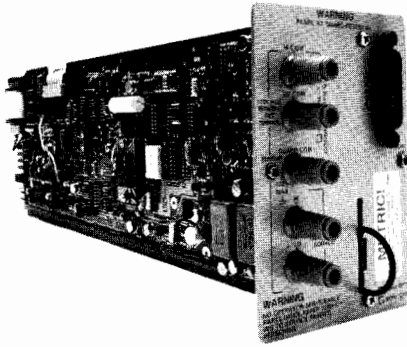

Option 001—5½ Digit DVM and Current Source

The 3497A DVM assembly is a systems quality, 5½ digit, 1 micro-volt sensitive DC Voltmeter. The DVM is fully guarded and uses an integrating A/D conversion technique; this yields excellent common and normal mode noise rejection.

Included on the DVM assembly is a three level programmable current source. The current source, when used simultaneously with the DVM, can be used to make high accuracy four terminal resistance measurements with 1 milliohm resolution. Maximum speed is 300 readings per second in 3½ digit mode.

Voltmeter Specifications

Range	Max. Display	5½ Digit Resolution	Accuracy 90 Days, 23°C ± 5°C 5½ Digits	Input Z
.10 V	±.119999	1 μV	±(.007% RDG + 3 counts)	10 ⁹ Ω
1.0 V	±1.19999	10 μV	±(.006% RDG + 1 count)	10 ⁹ Ω
10.0 V	±11.9999	100 μV	±(.006% RDG + 1 count)	10 ⁹ Ω
100.0 V	±119.999	1 mV	±(.006% RDG + 1 count)	10 ⁹ Ω

Maximum Input Voltage

High to low: 120 V peak

Low to guard: 170 V peak

Guard to chassis: 170 V peak

Current Source

Accuracy: 90 days

Range	23°C ± 5°C
10 μA	2.5 nA
100 μA	25.0 nA
1 mA	250 nA

Compliance: >+15 volts

Isolation voltage: 170 volts peak

General Information

Maximum Reading Rate: (readings/second)

Auto Zero	60 Hz Operation Digits Displayed			50 Hz Operation Digits Displayed		
	5½	4½	3½	5½	4½	3½
ON	25	100	150	20	83	125
OFF	50	200	300	40	166	250

Delay: 0 to 99.9999 sec. in 100 μs steps

Buffer size: packed format: 100 readings; ASCII format: 60 readings

Number of readings per trigger: 1 to 999

Measurement Speeds

For the 3497A DVM and the relay multiplexer, speeds are given for measurements on random channels (using software channel selection) and sequential channels (using external hardware increment). Speeds include I/O times to the indicated computers.

60 Hz Operation (50 Hz operation)

	Number of Digits Selected	Computer 9826*			
		85	1000L	1000E,F	
Sequential Channels using external increment	5½ digits	39 (33)	39	39 (25)	30 (25)
	4½ digits	97 (88)	103	108 (79)	88 (79)
	3½ digits	112 (107)	123	127 (99)	107 (99)
Random Channels using software	5½ digits	13 (11)	27	21 (16)	22 (16)
	4½ digits	14 (11)	51	31 (28)	35 (30)
	3½ digits	14 (11)	55	33 (29)	35 (32)

*9826 speeds for BASIC operating system

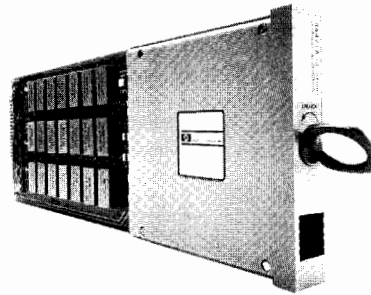

Option 010—20 Channel Relay Multiplexer

This assembly uses reed relays to multiplex signals to the DVM or other instruments. Each assembly switches 20 channels, each channel consists of HI, Lo, and Guard lines. Two channels may be closed per assembly and relays may be closed in a random sequence or incremented between programmable limits. The low thermal offset of the relays make it suitable for measuring the outputs of strain gage and other transducers. Each channel can be configured with a filter or current shunt for additional flexibility.

Input Characteristics

Maximum input voltage: < 170 V peak between any two input terminals

Maximum current: 50 mA per channel non-inductive

Maximum power: 1 VA per channel

Thermal offset: direct Switched: < 1 μV Differential, Tree Switched: < 2 μV Differential

Closed Channel Resistance

In series: 100 Ω ± 10% in High, Lo and Guard

Relays contacts only: < 1 Ω per contact

Open channel isolation: > 10¹⁰ Ω (Hi to Lo, 40°C, < 60% R.H.)

Maximum switch rate: 475/second (using hardware increment)

Rated switch life at 1 VA: 10⁷ operations

All Relays are Break-Before-Make

Option 020—Relay Multiplexer with Thermocouple Compensation

The option 020 assembly uses the same relay multiplexer as option 010 but incorporates a special isothermal connector block to allow thermocouple compensation. Two types of compensation (selectable by the user) are available. A temperature-dependent voltage is generated for software compensation; this voltage is then used in a computer program to compensate the thermocouple voltage. Hardware compensation involves inserting a voltage in the measurement circuit that automatically compensates the thermocouple voltage.

Reference Junction Compensation Comparison

	Software	Hardware
Compatible Thermocouples	Any mixture	One of the following types: B,E,J,K,R,S,T
Measurement channels available per assembly	19	20
Reference junction compensation accuracy (23° C ± 5° C)	.1°C	

DATA ACQUISITION, CONTROL & TEST

Data Acquisition/Control Unit (cont.)

Model 3497A

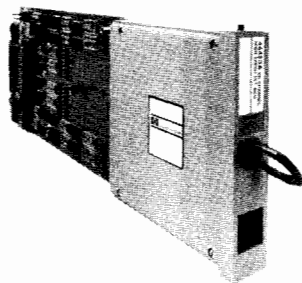

Option 030-20 Channel FET Multiplexer Assembly

The option 030 assembly is used to multiplex input signals to a DVM in a manner similar to option 010. The option 030 assembly provides high speed, low level multiplexing. Maximum signal levels are 12 volts peak between any high, low or guard input and any other guard input, guard common or chassis ground.

Maximum sequential scanning rate: 4800 readings/sec (at 60 Hz) using an HP 3437A Voltmeter and Series 200 computer. 4000 readings/sec at 50 Hz power.

Bias currents: sourced by either high or low to guard

	0-28°C	28-55°C
Channel closed:	± 300 nA	Current doubles
Channel open:	+ 15 nA	every 15°C
From each deselected FET assembly:	± 15 nA	above 28°C

Differential offset voltage: includes effects of bias currents and series resistance. Does not include effects of voltmeter bias and noise currents.

	0-28°C	28-55°C
± 1.4 mV		Add ± 140 μV/°C for each degree above 28°C
± 0.15 mV per deselected FET assembly		Add ± 15 μV/°C above 28°C for each selected FET assembly

Series resistance for each input: intrinsic resistance of the FET switch (when ON) plus series protection resistor.

	0-55°C
High, low	5500 Ohms
Guard	3500 Ohms

Maximum current: ± 1 mA per channel

Option 050— 16 Channel Isolated Digital Input/Interrupt

The option 050 assembly can sense up to 16 channels of digital data. The first 8 channels can also be used as interrupt lines to detect transient signals. The assembly can accept a wide range of input levels and all functions and masks are fully programmable. A five volt supply is provided for driving external contact closures and open collector outputs.

Input Signal Characteristics

Input Level	Low Voltage Maximum	High Voltage Minimum	Maximum Input Voltage Between High & Low Terminals	Minimum Input Current
5 V	0.8 V	2.4 V	30 V	400 μA
12 V	3.0 V	7.0 V	42 V	1 mA
24 V	6.0 V	13.0 V	42 V	2 mA

Maximum voltage: ± 170 V peak between any terminal and chassis
Logic polarity: positive True (Negative True is Jumper Selectable)

Interrupt Mode (bits 0-7)

Minimum pulse width: 100 microseconds

Triggering: each interrupt line is individually programmable for positive or negative edge triggering.

Masking: each interrupt line may be enabled or disabled using a programmable mask.

Option 060— 100 kHz Reciprocal Counter

This option can be used to measure mechanical and low frequency electronic signals. The counter can measure the period of signals up to 100 kHz and the pulse width of signals down to 18 μs. The counter can also count up or down from a programmable start point. It can accept a wide variety of input signals including CMOS, open collector TTL and passive contact closures.

Input Signal Characteristics

Input Levels

Input Level Range	V(Lo) (Maximum)		V(Hi) (Minimum)	
	Isolated	Non-iso	Isolated	Non-iso
5 V	1.0 V	1.0 V	4.2 V	4.2 V
12 V	1.8 V	2.7 V	10.3 V	8.0 V
24 V	2.6 V	6.0 V	18.4 V	16.5 V

(5 V level is standard, 12 and 24 volt levels are jumper selectable. Other voltages can be accepted using customer supplied resistors.)

Input circuit: switch selection of optically isolated or non-isolated input. Non-isolated input has 19.5 kΩ minimum input impedance.

Maximum isolation voltage: 170 V peak between any terminal and ground. Isolated mode only.

Period Mode

Maximum input frequency: 100 kHz

Minimum on time: 5 μs

Minimum off time: 5 μs

Range Characteristics

Range	Least Significant Digit (LSD)	
	HP-IB	Display
9999.999 s	1 ms	10 ms
99.99999 s	10 μs	100 μs
0.9999999 s	100 ns	1 μs
.09999999 s	10 ns	1 μs

Accuracy: ± (0.1% of reading + 2 LSDs + Trigger Error)

Pulse Width

Minimum start to stop time: (pulse width): 18 μs

Minimum stop to start time: 18 μs

Range Characteristics

Range	Least Significant Digit (LSD)	
	HP-IB	Display
9999.999 s	1 ms	10 ms
99.99999 s	10 μs	100 μs
0.999999 s	1 μs	1 μs
.099999 s	1 μs	1 μs

Accuracy: ± (0.1% of reading + Trigger Error + (2 LSDs or 18 μs, whichever is greater)).

Totalize/Down Count Mode

Maximum input frequency: 100 kHz

Minimum pulse width: 5 μs

Range: 0 to 999,999

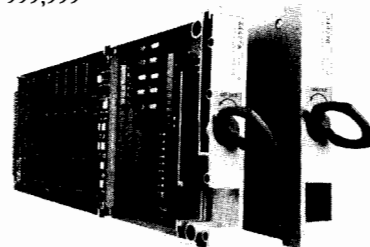

Option 070— 120 Ohm Strain Gage/Bridge Completion Assembly

Option 071— 350 Ohm Strain Gage/Bridge Completion Assembly



The option 070/071 assemblies may be used to provide bridge completion for measuring strain gages, RTD's pressure sensors and load cells. Each card uses an internal shared half bridge and can complete 10 channels of ¼ and ½ and full bridges in any combination. When used with a +5 V excitation supply (such as the HP 6214A) and the 3497A DVM, the assembly provides .1 μ E sensitivity with 1 μ E accuracy. Provisions are made for shunt calibration and checking gage leakage and lead resistance.

Specifications

Bridge Type	Sensitivity (excitation voltage at 5 volts)		Accuracy	
	3497A DVM	3456A DVM	Range at Best Resolution	90 Day 23°C ± 5°C
¼	.4 μ E	.04 μ E	42400 μ E	25 μ E
½	.2 μ E	.02 μ E	21200 μ E	5 μ E
Full	.1 μ E	.01 μ E	9500 μ E	1 μ E

Excitation Supply Requirements

V max: 5.4 Vdc; I (out): 250 mA per 10 channels (120 ohm gages)

Option 110 16 Channel Actuator

Option 115 8 Channel High Voltage Actuator

Option 110 consists of 16 mercury wetted form C (single pole-double throw) relays. Each relay can be individually closed and can switch one amp at 100 volts. The actuator assembly can be used to switch test fixture power or to actuate alarm bells. This flexibility of this assembly allows it to be used as a digital output or matrix switch.

Option 115 is an 8 channel high voltage actuator assembly that can switch voltages up to 252 VRMS and currents up to 2 amperes. The Option 115 assembly is ideal for switching power line voltages to small motors, alarm bells and lights, motor starters and solenoids.

Option 110 and 115 Specifications

	Option 110	Option 115
Switch Form	C	A
Contact Type	Mercury Wetted	Dry
Number of channels	16	8
Maximum Voltage	100 V Peak	252 VRMS 48 VDC
Maximum Current	1 amp	2 ARMS or DC
Maximum Power	100 VA	500 VA AC 60 VA DC

Option 120—Dual Voltage D/A

Option 130—Dual Current D/A

Option 120 consists of two 0 to ± 1 10 V programmable voltage sources. These sources can be used to provide a programmable test stimulus or to control voltage programmed devices like power supplies and VCO's.

Option 130 consists of two 0 to 20 mA or 4 to 20 mA programmable current sources. These sources, especially when using the 4 to 20 mA range, can be used as transmitters in industrial current loops and can drive up to 600 ohms of total loop resistance.

Option 120 Specifications

Output: 13 bits including polarity

Least significant bit: 2.5 mV

Output range: -10.2375 V to +10.2375 V

90 day accuracy: $\pm .070\%$ of programmed value ± 4.0 mV

Maximum output current: 15 mA (output within specifications)

Option 130 Specifications

Output: 12 bits

Least significant bit: 5 μ A (0 to 20 mA range)

4 μ A (4 to 20 mA range)

Output range: 0 to 20.475 mA or 4 to 20.380 mA (each source jumper selectable)

90 day accuracy: $\pm 0.07\%$ of programmed value ± 10.0 μ A

Compliance voltage: 12.0 volts

Option 140 Breadboard Card

Option 140 is a breadboard card compatible with the 3497A card-cage. Using this card, 3497A users can construct special purpose assemblies that communicate with the 3497A backplane.

Option 232 RS232C Interface

Option 232 to the 3497A deletes the standard HP-IB interface and adds an RS232C (CCITT/V.24) compatible interface. The option 232 interface is also compatible with the new RS423 (CCITT/V.10) version of the RS449 interface.

The option 232 interface allows you to remotely locate the 3497A. HP technical brochure part number 5952-8884 contains additional information on 3497A option 232.

Option 298—3498A Extender

The 3498A Extender chassis allows low cost expansion of 3497A-based systems. Each 3498A can hold up to ten 3497A plug-in assemblies. Use of one or more 3498A's requires a 3497A (for control); all required connecting cables are supplied with the 3498A.

Number of slots per 3498A: 10

Maximum number of added analog multiplexer channels (options 010, 020): 900 channels (45 assemblies)

Maximum number of added non-analog acquisition assemblies (options 050, 060, 110, 120, 130): 85 assemblies

Maximum number of 3498A's per 3497A: 13

General

Size (3497A or 3498A): 190.5 mm H x 428.6 mm W x 520.7 mm D (7½" x 16⅞" x 20½")

Net weight: 3497A, 20.4 kg (45 lbs.) and 3498A, 20.4 kg (45 lbs.) with assemblies in all slots.

Shipping weight: 3497A and 3498A maximum with assemblies in all slots are 26.3 kg (58 lbs.)

Operating temperature: 0°C to 55°C

Non-operating temperature: -40°C to 75°C

Humidity: to 95% at 40°C except as noted

Operating power: switch selection of 110, 120, 220 and 240 volts $\pm 10\%$, 48-66 Hz, 150 VA 3497A and 3498A.

Ordering Information

Price

Each 3497A can hold one DVM assembly (Opt 001) and up to 5 plug-in assemblies. Each 3498A (Opt 298) can hold 10 additional plug-ins. For plug-ins in excess of cardcage capacity, order as 444XXX Field Installation Kits.

Required on Every Order:

- A Clock Format (Option 230 or 231)
- A Power Line Frequency and Voltage (Options 315 through 346)

Opt 001: 5½ Digit DVM and Current Source

Opt 010: 20 Channel Relay Multiplexer Assembly

Opt 020: Relay Multiplexer Assembly with thermo-couple compensation

Opt 030: 20 channel FET Multiplexer Assembly

Opt 050: 16 channel isolated Digital Input/Interrupt Assembly

Opt 060: 100 kHz Reciprocal Counter;

Opt 070: 120 Ohm Strain Gage/Bridge Completion Assembly

Opt 071: 350 Ohm Strain Gage/Bridge Completion Assembly

Opt 110: 16 Channel Actuator/Digital Output Assembly

Opt 115: 8 Channel High Voltage Actuator Assembly

Opt 120: Dual Output Voltage DAC Assembly

Opt 130: Dual Output Current DAC Assembly

Opt 140: Breadboard Card

Opt 230: Clock Format (Month:Day:Hours:Min:Sec)

Opt 231: Clock Format (Day:Month:Hours:Min:Sec)

Opt 232: Delete HP-IB Interface, add RS232C Interface

Opt 260: Delete Keyboard and Display

Opt 298: Add 3498A Extender & connecting cables

3497A Data Acquisition/Control Unit

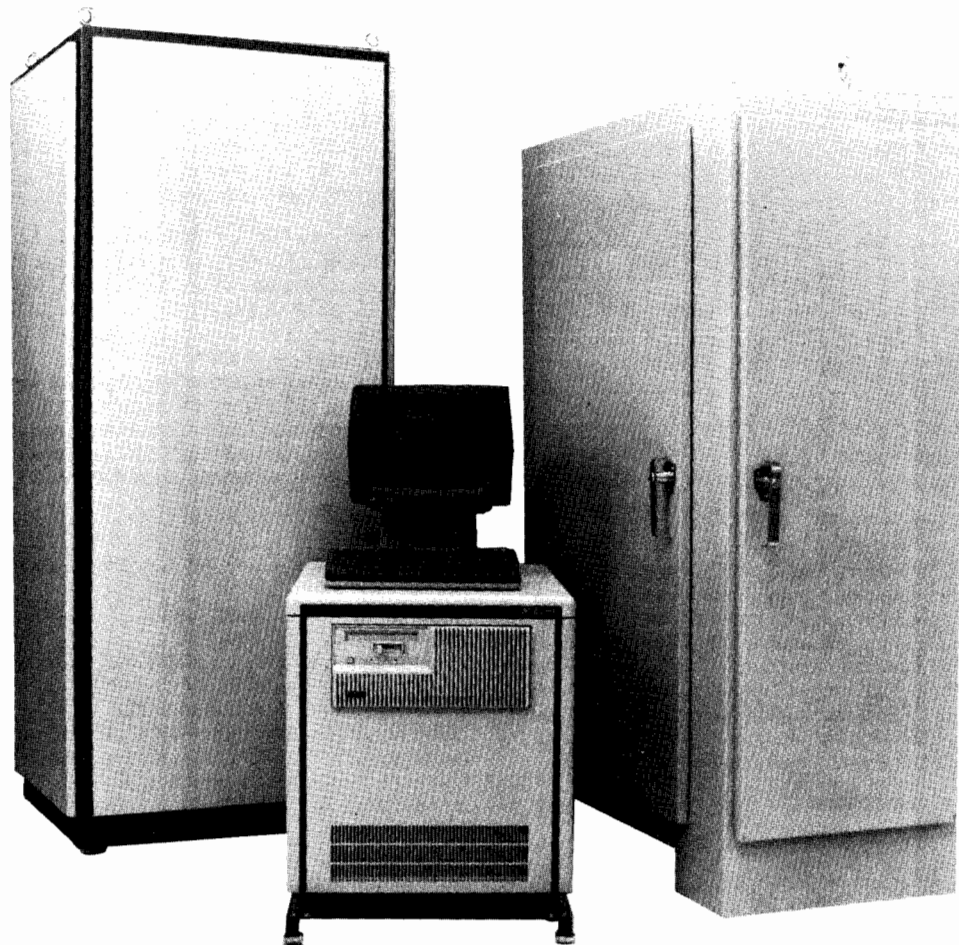

System Description

The HP 2250 Measurement and Control Processor is the nucleus of a family of HP automation systems that provide powerful capabilities for laboratory and industrial automation applications. The HP 2250's modular hardware structure gives you the versatility of selecting only the product you need for a cost-effective solution to your specific automation problem—yet you have the flexibility to expand your capabilities as your automation needs grow.

The HP 2250 operates in conjunction with an HP 1000 or HP 9800 series computer via the HP-IB, Hewlett-Packard Interface Bus, our implementation of IEEE Standard 488-1978 and identical ANSI Standard MC1.1. A single HP-IB cable connection is all that is required to link your computer to the HP 2250, creating a high-performance automation system. For those applications that require the 2250 to be remotely located, a coaxial cable or fiber optic HP-IB extender is available to extend the computer/2250 link up to 1000 metres.

The HP 2250 has a built-in LSI microcomputer and MCL/50 firmware, a software command set comprised of over 100 applications oriented mnemonic commands that can be used in many combinations to optimize measurement and control operations. MCL/50 Measurement and Control language software is easy to learn and use, allowing a user who is not a computer scientist to program his applications and control all 2250 function cards without tying up or intervention from the host computer. This decoupled operation facilitates a simpler and faster implementation of your automation solution, and results in more predictable and repeatable performance.

Measurement and control applications exist in many different environments—and the modular HP 2250 hardware is designed with the flexibility to meet the diverse requirements of these applications. A comprehensive set of high performance analog and digital function cards are available to interface to the broad range of sensors and actuators commonly found in laboratory and industrial environments today. Additionally, most function cards include provisions for on-board signal conditioning modules that permit accurate and reliable interfacing in demanding industrial applications. Also available are convenient industrialized field wiring assemblies accommodating up to 10 AWG wire.

System Features

- High-performance analog measurement capability includes
 - 14-bit resolution and 17-bit dynamic range
 - 0.08% accuracy from 0 to 50°C
 - 50,000 samples per second average throughput to disc
 - 45,000 samples per second paced throughput to disc
 - 350 Volt common mode protection
 - isolated voltage and current outputs
- Wide range of function cards are available, with 42 separate, plug-on signal conditioning modules.
- HP MCL/50 high level command set enables real-time task delegation and decoupled controller operation.
- Solid state output relay digital design is ruggedized to enable mechanical relay replacement.
- All I/O points can be floated or isolated.

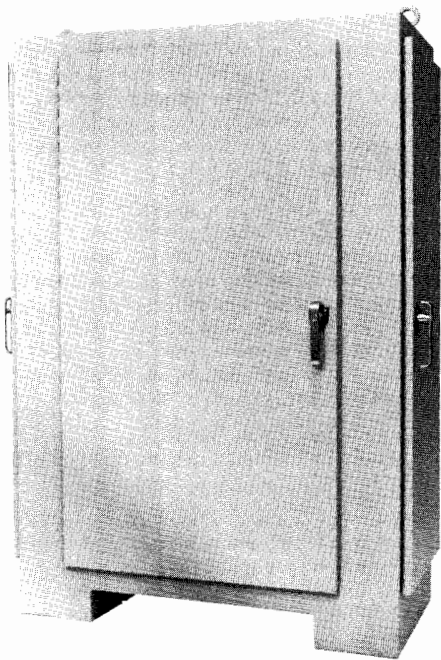

2250A Industrial Measurement and Control System

The 2250A is a complete measurement and control system in an industrial package. This system is designed for local machine or process control in harsh factory environments. It has two separate compartments for field-wiring connections. A third compartment contains the 2104B processor unit and room for two 2251B Measurement and Control Units.

The 2104B Processor Unit provides the local intelligence for computer-decoupled operation. The hardware consists of a power supply, steel frame, and four printed circuit assemblies. The 2251B MCUs each contain one BIF (backplane interface) card, through which the processor unit communicates with measurement and control function cards, and space for 8 function cards. The function card interface directly with the automation application.

The processor unit in the 2250A includes an additional backplane where an HP 1000 L-series computer can be installed. This provides the capability of having the measurement and control system and its host computer built into an industrial package. The computer may be either stand-alone or part of a distributed systems network.

Features

- Integrated measurement and control system in an industrial NEMA-12 package
- Integral mounting panels for supporting field wiring assemblies
- Removable metal access plates allowing conduit exit and entry for field wiring
- Space for two 2251Bs
- System power distribution unit with built-in power switch
- Separate lockable compartments for electronics and field wiring
- Floor-standing

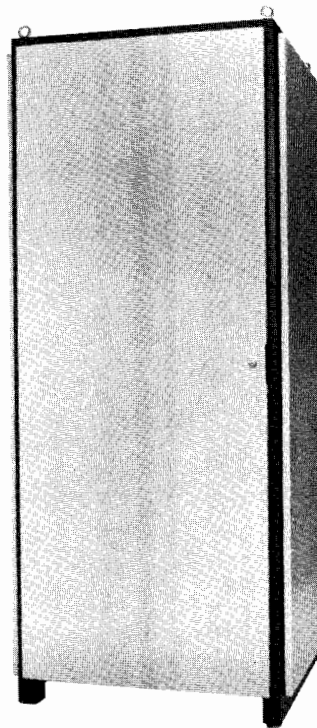

2250H Measurement & Control System

The 2250H is a complete measurement and control system in an upright, standard 19 inch cabinet. This system is appropriate for large point count interfacing to laboratory and industrial processes. The 2250H contains a 2104B processor unit and room for two 2251Bs. In addition, the 2255H may be added to expand the space available for both 2251Bs and field wiring assemblies.

Features

- Integrated measurement and control system in an upright rack cabinet with locking doors
- Integrated mounting panels for supporting field wiring assemblies
- Space for two 2251B Measurement and Control Units
- System power distribution unit with built-in power switch
- 2255H expands system capability to four 2251Bs.

Ordering Information

2250A Industrial Measurement and Control System

2250H Measurement and Control System

2255H Measurement and Control Subsystem

2104B Processor Unit

2251B Measurement and Control Unit

25501B 16 Channel High Speed Analog Input Card

25502B 32 Channel High Level Multiplexer Card

25503B 32 Channel Low Level Multiplexer Card

25503C 32 Channel Low Level Multiplexer with Thermocouple Reference Connector

25504B 16 Channel Relay Multiplexer Card

25504C 16 Channel Relay Multiplexer with Thermocouple Reference Connector

25510B 8 Channel Isolated Voltage/Current Analog Output Card

25511B 32 Channel Digital Input Card

25512B 4 Channel Counter Card

25513B 32 Channel Digital Output Card

25514B 16 Channel Relay Output Card

25515B 4 Channel Pulse Output Card

25516B 16 Point In/16 Point Out Digital Multifunction Card

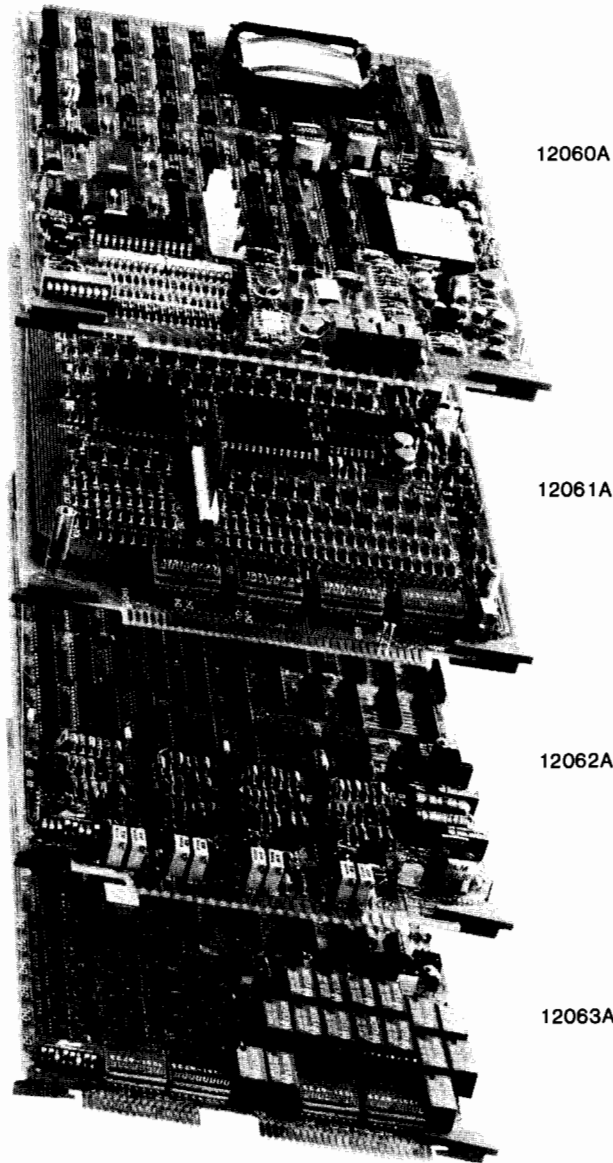

Description

The 12060A, 12061A, 12062A, and 12063A are plug-in cards for HP 1000 A-Series Computers. They provide low cost, high performance, analog and digital I/O for use in distributed measurement and control applications. The A-series product in which these cards are used must have a 25 kHz power supply. Hood connectors with each card allow the user to build cables for connection to his application.

12060A 8 Channel Analog Input Card

The 12060A is capable of acquiring up to 55,000 readings per second with 12-bit resolution. Auto scanning or single-channel sampling is possible to 55 kHz. Provisions for external pacing/trigging of sampling and scanning is provided. The 12060A includes four programmable full scale ranges from plus or minus 1.28 V to plus or minus 10.24 V. Maximum resolution is 0.625 mV on the 1.28 V range. A separate "zero reference" on the card allows the user to measure actual offset due to temperature drift, and correct readings on all channels for higher accuracy. The card has 8 differential channels.

12061A 32 Channel Analog Input Expansion Card

The 12061A provides 32 additional differential inputs for the 12060A card. The 12061A card fastens directly onto the 12060A card, creating a two-board unit that occupies two I/O slots in an HP 1000 A-series computer. Programming information is passed from the 12060A directly to the 12061A; analog signals on the additional 32 channels are in turn passed back to the 12060A for digitizing. The 12061A includes removable plug-in headers so the user can add current sense resistors for current loop measurements. These headers allow the board to be adapted to the specific application without soldering components directly on the board and are easily removable for repair purposes.

12062A 4 Channel Analog Output Card

The 12062A Analog Output Card provides 4 independent bipolar voltage outputs. Remote sensing per channel provides accurate output voltages to compensate for long distances of field wiring. Undedicated digital outputs may be used in pen up/down control, CRT display, or X-Y plotters. DMA compatibility provides fast analog updates on a per channel basis or between channels. Programmable time delay between DMA updates provides signal reconstruction capability with a full power bandwidth of 20 kHz.

12063A 32 Channel Digital Multifunction Card

Input Characteristics

The 12063A provides 16 fully isolated digital inputs via voltage threshold opto-couplers. Input voltage levels are selectable by the user for each channel by installing the appropriately valued resistors on removable plug-in headers (8 resistors per header = 8 channels). These headers allow the board to be adapted to the specific application without soldering components directly on the board, and are easily removed for repair purposes. Plug-in opto-couplers (supplied) allow user selection of ac or dc coupling for each channel by merely installing the opto-coupler in the ac position or dc position. For ac coupling, a plug-on jumper is provided for each channel to select 60 Hz ac filtering of the rectified input if desired.

Event Detection

In addition to status, any input may be user programmed to function as an interrupt to be generated on the rising edge or falling edge of the input or both (whichever occurs first). This capability is easily activated by the user via loading the appropriate pattern into the three registers. The on-card microprocessor takes over to cause the interrupt to be generated when that event occurs. User programming is required to service the interrupt.

Debounce Delay

The same microprocessor also provides the user programmable debounce delay up to 246 msec on any input when monitoring contact closures, and may be used in both status mode and event sense mode.

Output Characteristics

Sixteen form C (SPDT) relay outputs are provided on the same card. Both the normally open (NO) and normally closed (NC) contacts are available to users. Two removable headers allow for arc suppression devices to be added by the user for each channel without soldering directly to the board. Each header handles 8 output channels. Plug-on jumpers select the arc suppression across the NO or NC contacts. An on-card isolated power supply derived from the 25 kHz ac supply in the A-Series processor provides coil power for the relays. This technique minimizes any coupling of relay contact noise in the computer itself.

Ordering Information

- 12060A 8 Channel Analog/Digital Converter
- 12061A 32 Channel Analog Input Expansion
- 12062A 4 Channel Digital/Analog Converter
- 12063A 32 Channel Digital Multifunction Card

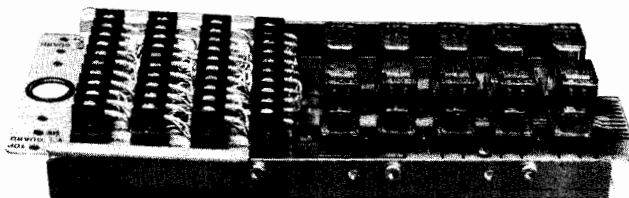
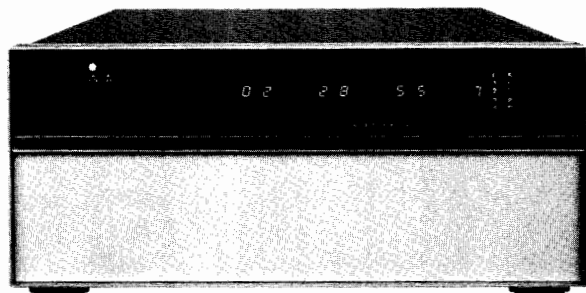

Option 002

Description

General

The 3495A Scanner switches analog input signals to an appropriate measuring device (voltmeter). It can also control external devices with relay actuator closures. Ideal for many data logging and data acquisition applications, the scanner can be used for sequential or random scanning. Any Hewlett-Packard Interface Bus (HP-IB) compatible controller can be used to operate the Scanner. Any combination of four relay assemblies (discussed below) can be used per scanner mainframe. More than four assemblies requires additional scanner mainframes.

Five optional relay assemblies are available with the scanner, four low thermal assemblies and one actuator assembly.

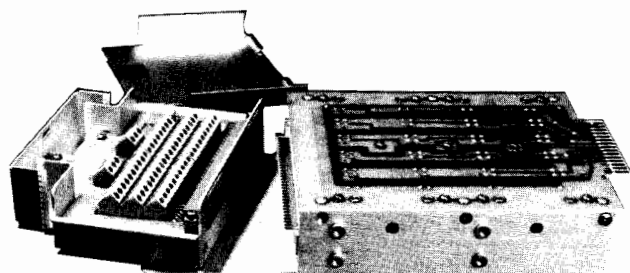

Option 004

Low Thermal Relay Multiplexer Assemblies

These assemblies are used to multiplex signals into a common detector, often a digital voltmeter. Typical applications are the multiplexing of low level dc voltages and resistances like the outputs of thermocouples, thermistors, strain gages and other transducers. Options 001 and 004 have 10 and 20 channels respectively. Options 003 and 005 have 9 and 19 channels respectively, an isothermal connector block and a thermistor to sense the temperature of the isothermal block. This gives options 003 and 005 thermocouple compensation capability.

Multiplexer Comparison

	Option 001	Option 003	Option 004/005
Number of Channels	10	9	20/19
Voltage Maximum	230 V Peak	42 V Peak	42 V Peak
Current Maximum	200 mA	200 mA	40 mA
Thermal Offset	<2 μ V	<2 μ V	<1 μ V
Isolation	>10 ¹⁰ Ohms	>10 ⁷ Ohms	>10 ⁷ Ohms
Switching Time	10 msec max.	10 msec max.	10 msec max. 1 msec max. using 3495A high speed controller

Relay Actuator Assembly

Applications: process control, actuate visual or audio indicators, control high current relays, up to 2 × 5 × 2 Matrix switching.

Ten Channel Relay Actuator Assembly: This relay actuator assembly provides ten independently programmable 2-wire closures for controlling high current relays, distributing low current dc or ac voltages, or external control function. Each two-pole relay can switch currents up to 2 A rms. Any combination of channels on this assembly may be closed or opened simultaneously.

Maximum contact ratings: voltage: 100V rms; Current: 2 A rms; Maximum input voltage: 230V peak; Thermal offset: < 30 μ V differential EMF; Switching time: 40 ms max. (Caution: For use in circuits fused at 2 amperes or less and less than 200 VA).

General

Operating temperature: 0°C to +55°C

Humidity range: 95% R.H., 0°C to +40°C

Power: 100/120/220/240 +5%, -10%
48 to 66 Hz line operation, <100 VA

Size: 190.5 H x 428.6 W x 520.7 mm D (7.5" x 16.87" x 20.5").

Weight: depends on options. Net: 18 kg (39.6 lbs.) maximum with four relay assemblies. Shipping: 22 kg (48.4 lbs.) maximum.

Option

001: Ten Channel Low Thermal Relay Assembly

002: Ten Channel Relay Actuator Assembly

003: Nine Channel Reference Assembly With Thermocouple Compensation

004: Twenty Channel Low Thermal Relay Assembly

005: Nineteen Channel Reference Assembly With Thermocouple Compensation

100: High Speed Control Board

Field Installation Kits

44401A Ten Channel Low Thermal Relay Assembly

44402A Ten Channel Relay Actuator Assembly

44403A Nine Channel Reference Assembly With Thermocouple Compensation

44404A Twenty Channel Low Thermal Relay Assembly

44405A Nineteen Channel Reference Assembly With Thermocouple Compensation

44413A High Speed Control Board

In addition, options 001 or 004 can be field modified to include thermocouple compensation by ordering the appropriate terminal connectors.

Additional Terminal Connectors for

Ten Channel Low Thermal Relay Assembly 03495-64101

Ten Channel Relay Actuator Assembly 03495-64104

Nine Channel Thermocouple Reference Assembly 03495-64103

Twenty Channel Low Thermal Relay Assembly 03495A-64114

Nineteen Channel Thermocouple Reference Assembly 03495-64115

3495A Scanner

DATA ACQUISITION, CONTROL & TEST

Low Cost, Versatile HP-IB Switching

Model 3488A

- DC—300 MHz signal switching
- Matrix, multiplexer, & general purpose relays
- Digital I/O control & actuation
- Up to 50 channels
- 40 configuration storage registers
- 6 switch & control modules

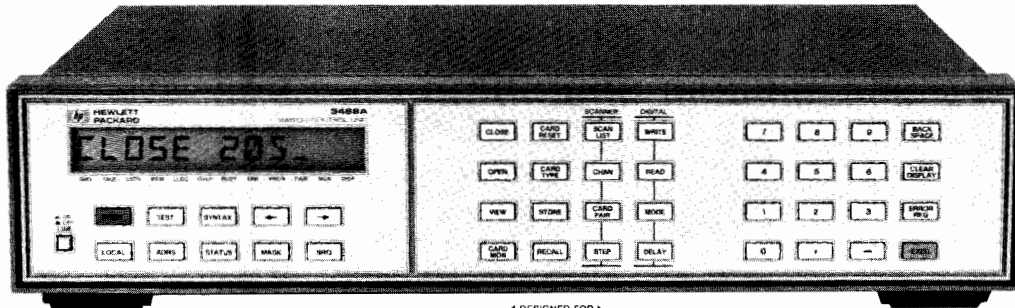

Description

The 3488A Switch/Control Unit brings versatile, HP-IB programmable switching to tests requiring multi-channel measurements. The 3488A provides signal switching with the integrity and isolation needed for high performance test systems in production. It also offers a flexible, low cost interconnection solution for automating experiments on the bench and for development testing in the lab. The 3488A is designed to hold any combination of up to 5 of the following optional switch and control modules:

- 10 Channel Relay Multiplexer
- 10 Channel General Purpose Relay
- Dual 4 Channel VHF Switch
- 4 x 4 Matrix Switch
- 16 Bit Digital Input/Output
- Breadboard

Flexible Switching

The 3488A offers an economical approach to switching flexibility through plug-in modules. The user can select the right combination of switching functions to meet both performance and budget requirements. Testing is simplified by having one solution for connections of low level DVM inputs, high level DC & AC power, and VHF signals to 300 MHz. Additional devices such as microwave relays and programmable attenuators are easily controlled with digital I/O functions. Custom circuitry can also be implemented on breadboard modules.

Versatile Performance

The 3488A can store up to 40 complete switch configurations for convenient recall in automated test programs. Switch operation can be with multiple relay closures or with selectable channels in a break-before-make mode. Break-before-make closures and recallable complete switch configurations can be combined in a programmable scan list. The 3488A uses removable screw terminal connectors that provide easily interchangeable wiring configurations for each test. Built-in self-test capability assures proper operation.

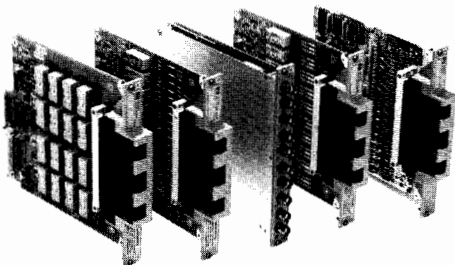

Multiplexer (option 010)

Option 010 is a 10 channel multiplexer for scanning or multiple signal connections. Channels switch 2 wires (Hi & Lo) with 2PST relays for DVM inputs and other signals up to 250 V and 2A. This module can also be used to multiplex signals to other switching functions such as the matrix module.

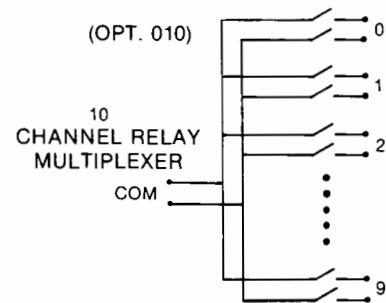

General Purpose Relays (option 011)

This module consists of 10 SPST independent relays for general signal switching and control of external devices. The quality connections provided make this module ideal for switching signals when multiplexing isn't required or for supplying switchable power to the device under test.

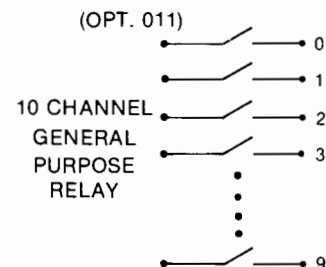

Matrix Switch (option 013)

Option 013 offers highly flexible switching with a 4 x 4, 2 wire matrix. Any combination of 4 input channels may be connected to any combination of 4 output channels. Each cross point or node in the matrix uses a 2PST relay to switch 2 lines (Hi & Lo) at a time. Multiple 4 x 4 modules can be connected to form larger matrices. Multiplexers can be used in conjunction with this module to effectively expand the number of inputs and outputs of the matrix.

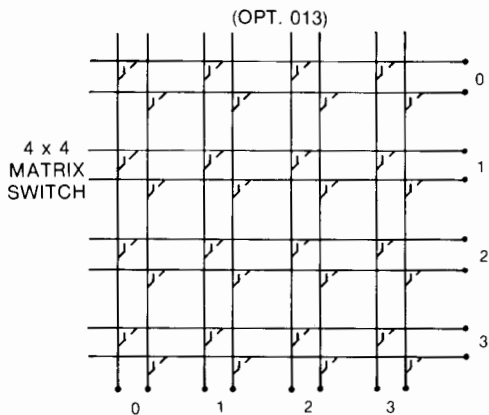

AC Isolation / Performance

(50 Ω termination)	100 kHz	1 MHz	10 MHz
Insertion Loss (dB)	<0.30	<0.35	<0.90
Crosstalk (dB)	<-73	<-53	<-33

Specifications For Option 012 VHF Switch Module

Input Characteristics

Maximum Voltage

Center-center, center-low: 250 V DC, 30 V AC RMS, 42 V AC Peak
Low-chassis, low-low: 42 V DC

Maximum current (per channel): 30 mA DC, 300 mA AC RMS

Maximum power (per channel): 50 W DC, 80 VA AC (<30 MHz), 15 dBm (30-100 MHz), 10 dBm (100-300 MHz)

Thermal offset: <15 μV per channel

Characteristic impedance: 50 Ω

AC Isolation / Performance

	30 MHz	100 MHz	300 MHz
Insertion Loss (dB)	<0.5	<1.0	<1.5
Crosstalk (dB) Channel-Channel, Channel-Common	<-100	<-80	<-60

All channels break-before-make within a group of 4 channels.

Specifications for Option 014 Digital I/O Module

I/O Lines

Maximum voltage = +30 V DC (Line-Chassis)

Output characteristics: V (high) ≥ 2.4 V; V (low) ≤ 0.4V

I (low) maximum = 125 mA @ V (low) ≤ 1.25 V; fused at 250 mA.

Input characteristics: V (high) ≥ 2 V; V (low) ≤ 0.8 V

External increment: advances 3488A to next programmed configuration on falling edge of TTL pulse.

Channel closed: indicates completion of new configuration; TTL pulse

General Specifications

Environmental

Operating Temperature: 0 to 55°C

Humidity: 95%, 0 to 40°C

Power: 86-132 V or 195-250 V switch selectable, 48 to 440 Hz; 18 VA.

Size: 89 mm H (without feet) x 425 mm W x 292 mm D (3.5" x 16.75" x 11.5"). Allow 76 mm (3") additional depth for wiring.

Weight: net: 9 kg (20 lbs.). Shipping: 18 kg (40 lbs.).

Connectors (all modules except option 012 44472A VHF switch): Removable screw terminal connector. Each terminal accepts 18-26 gauge (16-40 mils) wire, with strain relief for wiring. Option 012 44472A VHF Switch: BNC Connectors

Ordering and Configuration Information

Options

(Switch Modules-includes terminal connectors)

010: 10 Channel Relay Multiplexer Module

011: 10 Channel General Purpose Relay Module

012: Dual 4 Channel VHF Switch Module

013: 4x4 Matrix Switch Module

014: 16 Bit Digital Input/Output Module

015: Breadboard Module

Rack Mounting and Manuals

401: Side Handle Kit (P/N 5061-1171)

907: Front Handle Kit (P/N 5061-1170)

908: Rack Flange Kit (P/N 5061-1168)

909: Rack Flange with Handles (P/N 5061-1169)

910: Extra Operating & Service Manuals

3488A Switch / Control Unit

VHF Switch (option 012)

The VHF module provides broadband switching capability for high frequency and pulse signals. The 2 independent groups of bidirectional 1 x 4 switches can be used for signals from DC to 300 MHz. All channels have 50 ohm characteristic impedance and are break-before-make within a group of 4 channels. Each group is isolated from the other and from ground to prevent ground loops. Excellent isolation makes this module ideal for high frequency signal analyzer measurements requiring a large dynamic range.

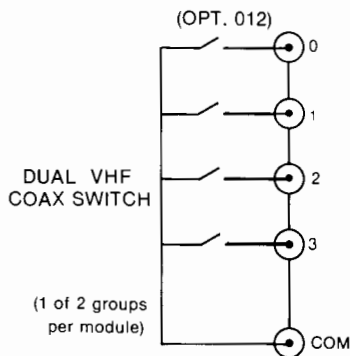

Digital I/O (option 014)

This module offers 16 very flexible bidirectional I/O lines and 4 TTL compatible handshake lines for sensing and control of external devices. The digital inputs can be used to sense contact closures to ground. Each channel provides current sinks for remote switching of external relays such as the HP 33311 series of coaxial switches.

Breadboard (option 015)

The breadboard modules provide a convenient way to implement custom circuits and special functions that interface directly with the 3488A's backplane control signals.

Specifications for Option 010 Multiplexer, Option 011 General Purpose Relay, and Option 013 Matrix Switch Modules

Input Characteristics

Maximum voltage (terminal-terminal or terminal-chassis): 250 V DC, 250 V AC RMS, 350 V AC Peak

Maximum current (per channel or module): 2 A DC, 2 A AC RMS

Maximum power (per channel or module): 60 W DC, 500 VA AC

Thermal offset: < 3 μV

DC Isolation (40°C, 95% RH)

Channel-channel, open channel: > 10⁹ Ω

DATA ACQUISITION, CONTROL & TEST

Multiprogrammer: Versatile Automatic Test, Data Acquisition and Control
Models 6940B and 6942A

*Use the MULTIPROGRAMMER to implement customized solutions for your
.....High Speed Data Acquisition
.....Computer Aided Test
.....Control Applications.
First select the MULTIPROGRAMMER, 6940B or 6942A, best suited for
your application.....*

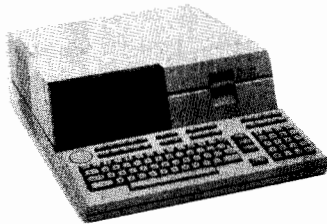

HP Desktop Computer

Then, Choose an HP Controller and Interface Kit . . . Use either a Desktop or Minicomputer . . .

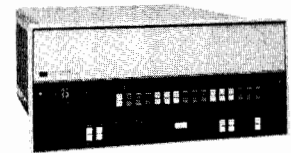

HP Minicomputer

Then select from a wide range of these MULTIPROGRAMMER CARDS for the MAINFRAMES . . .

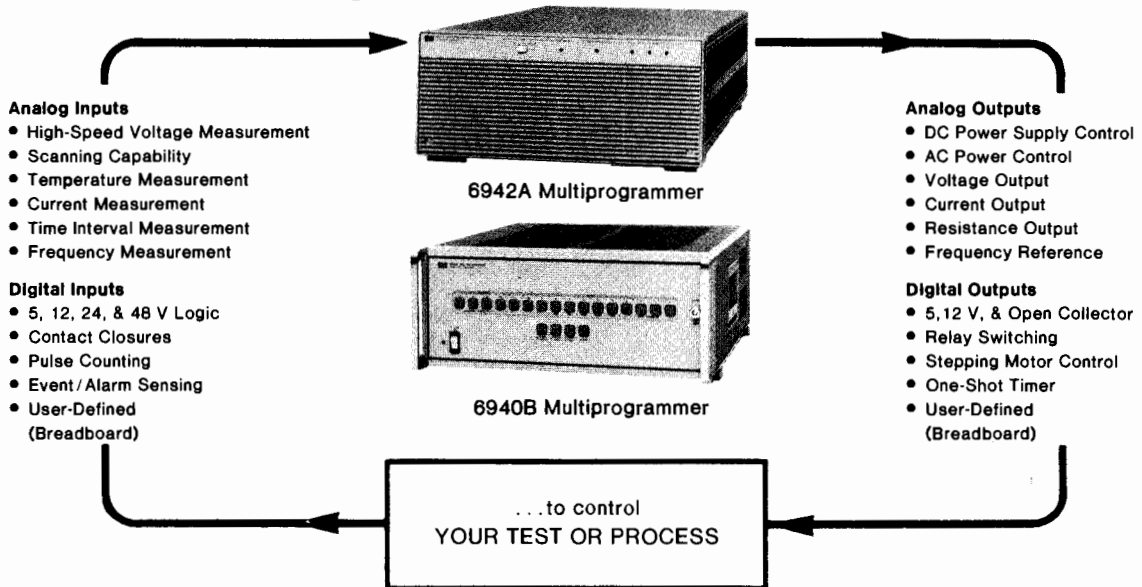

Introduction

The Multiprogrammers' high speed makes them well suited for data acquisition and Computer Aided Test applications. Voltage measurements can be acquired at 33,000 readings per second from a single channel, or from several thousand channels using the Multiprogrammers' scanning capabilities. Digital data can be acquired at a 125 kHz rate. Thousands of Multiprogrammers are in use in Computer Aided Testing of electrical and mechanical devices. They improve quality and productivity throughout the manufacturing process in areas like incoming inspection, component test, subassembly test, final test, life test, and quality control test. Multiprogrammers are also used in the R&D environment to automate both short and long term experiments.

The Multiprogrammer Family gives you the choice of two mainframes, the 6940B and the 6942A, and two new systems, the 6901S and 6942S. Both systems improve productivity: the 6942S speeds software development, and the 6901S allows you to begin making measurements immediately. The 6942A, 6942S, and 6901S all use the powerful Multiprogrammer Series II I/O cards.

Complete Technical Data

If you would like additional information on Multiprogrammer pro-

ducts we have a free, 68-page brochure on the 6940B and one on the 6942A. The brochures include detailed specifications, applications, programming, interfacing, and ordering information. Ask your HP Field Engineer for publication 5952-4077 (for the 6940B) or 5952-4089 (for the 6942A), or use the card at the rear of this catalog.

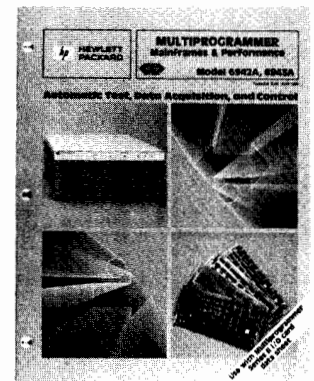
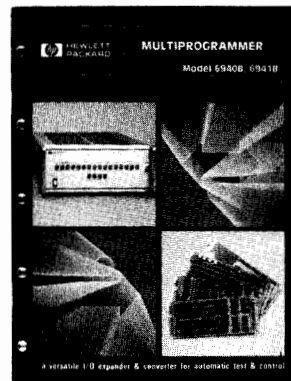

- Action-oriented instructions
- Isolated analog inputs and outputs
- Built-in self test

- Overlapped input and output
- Internal or external pacing
- Easy to configure

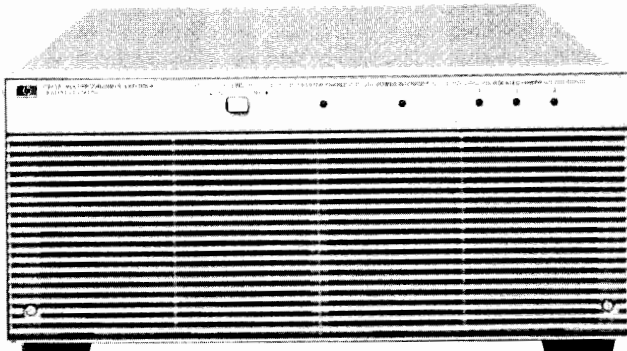

6942A



The Multiprogrammer Performs Operations in Parallel

With this one instrument you can control several processes at once. And, while you are controlling the processes, the Multiprogrammer can also be watching for interrupt conditions. The internal microprocessor manages all the parallel operations and monitors the alarm lines; when the operations have completed or if an alarm condition occurs, the Multiprogrammer interrupts the controller.

How does the 6942A Connect With Your Controller?

The 6942A Multiprogrammer interfaces with your controller (desktop or minicomputer) using the HP-IB, Hewlett-Packard's implementation of IEEE Standard 488 and the identical ANSI Standard MC1.1. Data and status readback make use of the extended bus addressing features of the HP-IB.

Programming Flexibility

Mnemonic, action-oriented instructions make the 6942A Multiprogrammer simple to learn and use. For instance, the output instruction "OP" works with all output cards. When you send an instruction, the internal microprocessor checks which type of card you are addressing and automatically converts the data to the proper format for that card. You select the units with which you want to program each card. Whether you want to use volts, millivolts, amps, degrees, feet, or any other units, the Multiprogrammer does the converting for you.

Mainframe Memory Unburdens The Controller

The mainframe memory of the 6942A will accept up to 76 instructions from the controller at one time. This leaves your controller free for other processing activities while the Multiprogrammer works on the I/O operations. This mainframe memory may also be used to collect up to 1440 data readings and hold them until the controller is free to take them. For even more data storage, 4K Memory Cards, 69790B, may be used to store 4096 16-bit words of input or output data.

Real Time Clock

Built-in real-time clock gives you time-of-day readings and pacing of measurements. The clock detects which power line frequency you are using, 50 Hz, or 60 Hz, and automatically synchronizes itself to this frequency. The range of the clock is 65,534 days, with resolution to a tenth of a second.

Computers and Documentation

The 6942A can be operated with a wide variety of computers, including the HP Series 80, Series 200, Series 1000, 9825, and 9845 computers. Documentation packages are available for all of these computers. Each one contains a User's Guide with programming examples, a utility program tape or flexible disc, operating and service manuals, and a binder to hold this material. One no charge documentation option must be specified to select the documentation appropriate for your computer.

Accessories

14700A extender kit: this kit contains the transmission boards which go into the master mainframe (6942A) and the last extender mainframe in the chain.

14701A intermediate extender kit: when more than two mainframes are in a chain, the card in this kit must be used in each intermediate extender mainframe.

14702A chaining cable: this is the cable which chains together the master and extender mainframes. One cable is required for each extender mainframe. Length: 1.5 m (5 ft).

14703A card edge connector: extra connectors for the I/O cards may be ordered in addition to the one supplied with each I/O card.

6942A / 6943A Specifications

Plug-in I/O card positions: maximum of 16 plug-in output or input cards per mainframe. Removable rear cover provides access to card slots.

Computer interface (6942A only): the Multiprogrammer is connected to a controller via the Hewlett-Packard Interface Bus (HP-IB), Hewlett-Packard's implementation of IEEE Std. 488.

Real time clock (6942A only): the built-in real time clock is automatically synchronized with the 50/60 Hz ac power line frequency. The clock is read and set with data in the form of days, hours, minutes and seconds with a resolution of 0.1 seconds.

Extender interface kits (6943A only): each 6943A Extender requires one 14700A or 14701A Interface Kit and one 14702A Chaining Cable for operation with the 6942A.

Maximum number of mainframes per chain: up to seven 6943A Multiprogrammer Extenders may be placed in a chain with one 6942A Multiprogrammer.

Maximum chain length: a chain of mainframes can be up to 152 meters (500 feet) long. This maximum length is the sum of the lengths of all 14702A Chaining Cables used in one chain.

Power supplies: all power supplies for up to 16 I/O cards are built-in including three ± 18 V supplies isolated from each other and from the ground.

Cooling: built-in forced air cooling draws air in through the front panel and exhausts air through the ventilated rear cover.

Front panel indicators: five light emitting diodes on the front panel indicate power supply and self-test status.

Operating temperature range: 0°C to 55°C.

Power: 100/120/220/240 Vac (selectable), +5%, -10%, 47 to 63 Hz, 600 VA.

Dimensions: 177.0 mm high x 425.5 mm wide x 597.0 mm deep, (6.969 in. high x 16.250 in. wide x 23.500 in. deep).

Weight (without I/O cards): net, 20 kg. (45 lbs). Shipping, 27 kg. (60 lbs).

Accessories furnished: PC board Extender Card (HP Part No. 5060-2792).

Ordering Information

Opt 010-386: One Set Documentation/Software

Opt 410-786: Extra Documentation/Software

Opt 908: Rack Flange Kit

Opt 910: Extra Manual

14700A Extender Interface Kit

14701A Extender Interface Kit

14702A Chaining Cable

14703A Spare Card Connector

14711A Field Service Kit

6942A Multiprogrammer

6943A Multiprogrammer Extender



DATA ACQUISITION, CONTROL & TEST

Multiprogrammer: Measurement & Analysis System

Model 6901S

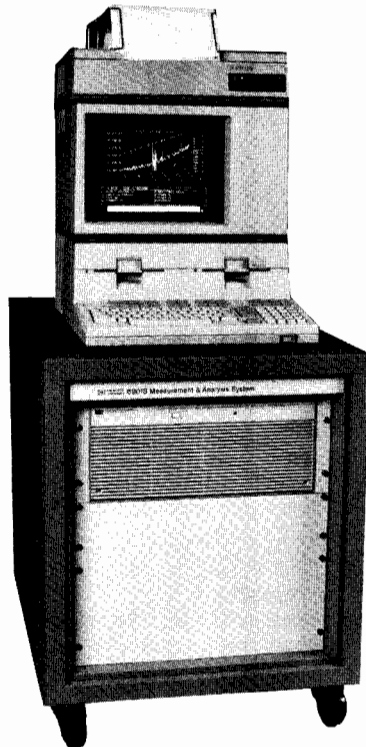

Description

Hewlett-Packard's new 6901S Measurement and Analysis System is a fully integrated, high speed, scanning system for measuring multiple channels of voltage, current or resistance. It's a complete, ready to use solution which improves productivity by allowing a user to begin making measurements immediately. And it also retains the flexibility to be customized for individual applications.

Easy to Use

A comprehensive software package makes the 6901S easy to use—for many applications, *no* software writing is required. Friendliness is enhanced via the use of descriptive menus. Sequencing of menus is controlled by the 6901S general purpose mainline program.

The system comes fully assembled in a desk-height rack which provides a convenient work surface for any of the HP Series 200 Computers. User connections are easily made with a screwdriver to a factory-wired termination panel in the rear of the rack.

Hardware Features

The standard HP 6901S will scan 1 to 64 single-ended, analog channels at up to 25,000 channels per second, or up to 100 scans per second with programmable limit checking. (A scan is one complete pass through every channel.) By adding additional scanning cards, the standard system can scan up to 256 channels, or up to 768 channels with user supplied termination panels. Options for double-ended and 4-wire scanning are also available.

As shipped, the 6901S will measure signals in the ± 10.23 volt range with 12 bit resolution. ± 1.023 volt and ± 102.3 millivolt ranges are switch selectable.

Software Features

The 6901S software includes one burst and three continuous scanning modes:

- Burst mode is used for applications requiring high speed scanning for up to 4095 readings.
- Limit mode is used to look at data before and after the occurrence of an out-of-limit condition on any channel. Both high and low limits are programmable for each channel.
- Strip chart mode produces a continuous hard copy record to indicate long term change.
- Running statistics mode outputs a statistical summary of long-term tests.

The 6901S graphics utilities support the following types of outputs: Multichannel plotting, histogram plotting, cumulative distribution plotting, and tabular listings. Interactive graphics are provided within

each plotting utility for extracting and analyzing the important information from the plots. The system also supports the HP 2671G Graphics Printer and three HP graphics plotters for hard copies and overhead transparencies.

Four of the HP Series 200 Computers can be specified with the 6901S. These are the Model 16S, 26S, 36S and 36CS computers.

Easy to Customize

Both the 6901S hardware and software can be easily customized for the customer with special needs. The standard system software makes use of many separate utilities, all of which are available to the user. Each one is written in BASIC, and can be accessed by the user by modifying the mainline program.

The 6901S is also easily customized by users with special hardware needs. By using the HP 14750A CAT Programming Package, included with the system, a variety of HP Multiprogrammer Series II I/O Cards can be added to the system. This family of 24 cards, described on pages 66 and 67, performs many functions. This type of customization makes the 6901S a partially integrated solution to a broad range of automatic test, data acquisition, and control needs.

Specifications

Maximum Scanning Rates (single-ended only)

Burst mode: 25 kHz (channels/second), ± 10 V, ± 1 V ranges
14 kHz ± 100 mV range
Buffer Size: 4095 words

Limit mode: 100 Hz (scans/second) with limit checking on up to 30 channels.

Strip chart mode: 1 Hz (scans/second) for any 8 channels.

Running statistics mode: 5 scans/second average for up to 16 channels with no more than 400 milliseconds between successive readings on any one channel.

Minimum Out-of-Limit Condition Duration of an Input Signal In Limit mode:

10 ms for 100 Hz scanning rate

Slots available for multiprogrammer cards: 16 (The standard system uses 5 of these.) Up to seven 6943A Multiprogrammer Extenders can be added external to the rack.

Operating temperature range (6901S): 10–40°C

Dimensions (6901A): 725 mm high x 600 mm wide x 900 mm deep, (28.6 in. high x 23.7 in. wide x 35.6 in. deep).

Power (6901A): 100/120/220/240 Vac (selectable), +5%, –10%, 47 to 63 Hz, 600 VA.

Weight (6901A): net, 81.7 kg. (180 lbs.). Shipping, 107 kg. (235 lbs.)

Ordering Information

Step 1: Specify the 6901S

6901S Measurement & Analysis System

Step 2: Order two RAM Boards and one Computer

Two 98256A 256 kbyte RAM boards @ \$1,060

9836CS Computer

9836S Computer

9826S Computer

9816S Computer, Option 630

9888A Bus Expander (required for 9816S only)

9121D 3½-in. Dual Flexible Disc Drives (9816S only)

10833A HP-IB Cable; 1 m (3.3 ft.) (9816S only)

98612A BASIC Extensions 2.0, Option 630: (9816S only)

Step 3: Specify 6901A with one media option

6901A Scanning Subsystem

Opt 630: 3½-in. flexible discs for 9121D

Opt 655: 5¼-in. flexible discs for 9826/9836

Step 4: Options 1, 2, or 3 may be ordered as alternatives to the 64 channel FET scanner. Order as many expansion options as required.

Opt 001: Substitute 16-Channel FET

Opt 002: Substitute 16-Channel Double Ended Relay

Opt 003: Substitute 16-Channel 4-wire Ohms Scanner

Opt 004: Add 16 FET Channels

Opt 005: Add 64 FET Channels

Opt 006: Add 16 Double Ended Relay Channels

Opt 007: Add 16 4-Wire Ohms Scanning Channels

Opt 008: Right to copy software (deletes SW)

Step 5: Select peripherals required for hard copy (2671G Printer, and 9872C, 9872T, 7470A Plotters)

DATA ACQUISITION, CONTROL & TEST

Multiprogrammer: Computer Aided Test System

Models: 6942S, 14750A

65



- Easy to use menu entry
- Faster software development
- Improved 6942A performance



Description

The new 6942S is an easy to use computer aided test system that improves productivity by letting you implement your test system more quickly. This is achieved through the use of a new software package which greatly speeds up software development. In addition to being friendly and easy to use, the system actually improves the performance of the 6942A Multiprogrammer. So not only will you develop your test set more quickly, but the test will also run faster, resulting in more tests per hour. The 6942S consists of the 6942A Multiprogrammer, any Multiprogrammer Series II I/O cards required, the new 14750A Computer Aided Test Programming Package, and a Series 200, Model 16, 26 or 36 computer.

New 14750A CAT Programming Package

The 14750A is a comprehensive collection of software routines that provides the ATE system designer with a high-performance linkage between the BASIC language and Multiprogrammer hardware. Both friendliness and higher performance are combined in the software through an architecture which optimizes total system performance.

Friendliness is achieved by replacing traditional "computer language" statements with test-oriented commands. Communications with all supported instrumentation are via "functional names", chosen by the user, which have a close relationship with the function performed. For example, in the menu below, the name "valve", is used to program a 69720A Voltage D/A Converter. This lets you program in terms that are familiar to you and results in programs which are virtually self-documenting. Friendliness is further enhanced by convenient menu entries, which make it easy to enter all function names and parameters.

Unlike traditional "friendly" software, the 14750A actually improves instrumentation performance. In general, INPUT and OUTPUT operations execute four times faster than the 6942A's native instruction set. This higher performance is the result of using compiled PASCAL subprograms—which are transparent to the user—to handle all instrumentation I/O. A separate HP-IB interface for the Series 200 computer, included with the 14750A, and a custom HP-IB driver are also used. Execution speed is further improved by bypassing the 6942A's internal microprocessor and sending data directly to the I/O cards.

The 14750A reduces the amount of software written by the user and thus speeds program development. This improves productivity by shortening test set development time. To create test software, the user enters functional names, and other data into a series of menus. Then a program is written in HP-enhanced BASIC to handle all sequencing, computational, and decision-making operations. Whenever a stimulus, acquisition or control function is desired, the BASIC program is instructed to call a 14750A routine configured via the menus.

14750A Features

Some of the 14750A features are highlighted in a menu below. The timeout feature can generate an error if an operation has not com-

User selected name matches test function

Stimulus, acquisition or control function selected from supported instrumentation.

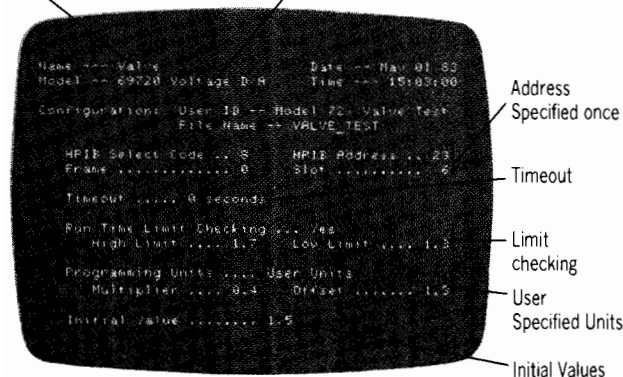

Address Specified once

Timeout

Limit checking

User Specified Units

Initial Values

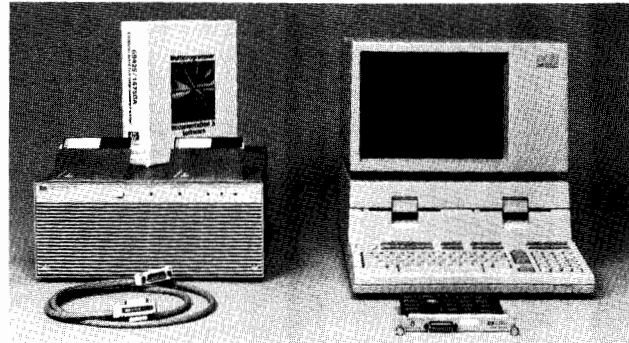

pleted in a specified time. Since the error can be trapped like any other BASIC error, corrective action can be programmed to occur automatically. Limit checking prevents out of range values from being executed, and data conversion permits programming with user specified units. Initial values can also be specified and, at run time, sent to all instrumentation with a single command.

Multiprogrammer Series II I/O Cards

The 14750A supports all present Multiprogrammer Series II I/O card functions, described on pages 66 and 67, and four popular multiple card functions. These include combinations such as using a high speed scanner, A/D, and memory card together. In addition, the 3478A 5½ digit Multimeter is supported for applications requiring high accuracy and high resolution measurements.

6942A Multiprogrammer

The Multiprogrammer is a high performance mainframe that provides the necessary interface for up to sixteen plug-in cards. Optional 6943A Multiprogrammer Extenders can be added to a system to further expand its capabilities. Up to seven Extenders, each holding up to sixteen plug-in cards, can be chained to one mainframe.

System Performance Specifications

NOTE: Specified times are for the 9826 and 9836 configurations. Actual times for the 9816 configuration may be slightly slower.

Single Point Data Transfer Rates (without scaling to user units)

Input: 1.9 ms

Output with limit checking disabled: 2.0 ms

Output with limit checking enabled: 2.1 ms

Scaling to user units: add 0.35 ms to the above times.

Block Data Transfer Rates

Block transfer overhead: 2.8 ms

Inputs: 12500 transfers per second

Outputs: 18000 transfers per second

Interrupt service response time: 13.7 ms

Ordering Information

Step 1: specify the 6942S

6942S Computer Aided Test System

Step 2: select Series II I/O Cards (pages 66 and 67).

Step 3: select one 6942A Multiprogrammer. Order a 6943A, Interface Kit, and Cable for each additional 16 slots.

6942A Multiprogrammer

6943A Multiprogrammer Extender

14700A Interface kit for first 6943A

14701A Interface for 2nd to 7th 6943A

14702A Chaining Cable, 1.5 m (5 ft)

Step 4: order two RAM boards and computer.

Two 98256A 256 kbyte RAM boards @ \$1,060

9836S Desktop Computer

9826S Desktop Computer

9816S Desktop Computer, Option 630:

9888A Bus Expander (required for 9816S only)

9121D Dual 3½" Floppy Drive (9816S only)

98612A BASIC Extensions 2.0, Option 630: (9816S)

Step 5: specify the 14750A with the appropriate option.

14750A Computer Aided Test Programming Package

Opt 630: 3½" flexible discs for 9121D

Opt 655: 5¼" flexible discs for 9826/9836

Opt 910: Extra set of documentation





DATA ACQUISITION, CONTROL & TEST

Multiprogrammer Series II I/O Cards

Models 69700A-69793A

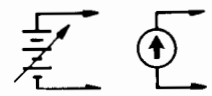
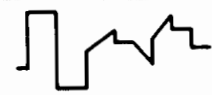
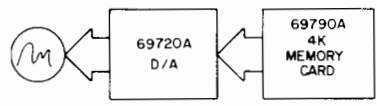
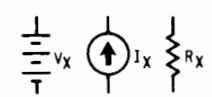
Multiprogrammer Series II I/O Cards for the 6942A, 6942S, and 6901S

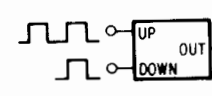
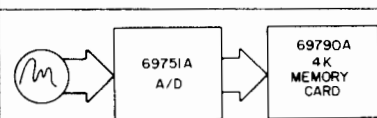
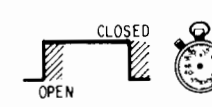
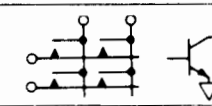
For a complete description of the Multiprogrammer Series II I/O Cards, ask for publication 5952-4090.

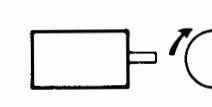
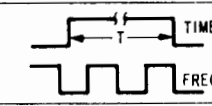
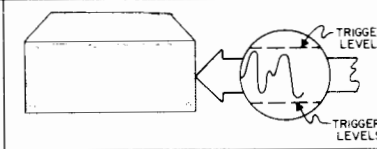
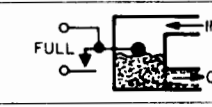
	Functions	Applications	Cards Used
S T I M U L U S	 <p>Programmable DC Voltage and Current</p>	The output voltage (up to 250V) and current (up to 1000A) of forty different HP power supplies can be programmed to provide bias in automatic test systems or control of electromechanical process equipment.	Resistance Output, 69700A-69706A; Power Supply Control, 69709A.
	 <p>Digital-to-Analog Conversion</p>	Twelve-bit voltage DAC's provide outputs for strip chart, x-y, and analog tape recorders as well as control of analog programmable instruments and stimulus of units under test. Control process equipment with 4-20 mA output.	Voltage DAC, 69720A; Current DAC, 69721A.
	 <p>Analog Waveform Synthesis</p>	The Memory card can continually supply pre-loaded data to the D/A card at rates of up to 100 kHz. Special waveforms may be loaded into the Memory card from the computer and used as stimuli for test and processes.	Memory card, 69790B; Voltage DAC, 69720A; or Current DAC, 69721A.
M E A S U R E M E N T	 <p>Voltage, Current, and Resistance Measurements</p>	A/D converters may be used to measure voltages from $\pm 50\mu\text{V}$ to $\pm 100\text{ V}$ in the presence of 250 V of common-mode noise. Connecting a resistor across the input permits current measurements for 4-20 mA current loops used in process control. Combine the A/D with the current DAC for resistance measurements.	High Speed ADC, 69751A.
	 <p>Frequency Measurements</p>	The Pulse Counter card accumulates counts over a precise time interval when a Timer card is connected to the enable line of the Counter. The program divides the count by the time interval to measure frequencies from 1 MHz to less than 0.001 Hz.	Counter, 69775A; Timer 69736A.
	 <p>Pulse Counting Preset Up/Down</p>	The Counter may be preset to any value within the count range of 0 to 65,535 and can cause an interrupt when it rolls over. The Counter may be enabled and disabled by pulses or levels. The computer may read the count without disturbing the counting process.	Counter, 69775A.
	 <p>Offline Analog Acquisition</p>	Differential or single-ended signals may be digitized at rates up to 33 kHz by the A/D, and stored on the Memory card. Each Memory card can store up to 4096 Readings. The digitizing process can take place independent of other Multiprogrammer activity.	High Speed ADC, 69751A; Memory card, 69790B.
	 <p>Time Interval Measurement</p>	Elapsed time between two events can be measured in the range of 10 μs to 65,000 days. The Counter card counts a known frequency over the unknown interval. This count is divided by the known frequency to determine the interval. For resolution of .1 sec, the built-in real time clock alone may be used. This real time clock provides time-of-day readings.	Counter 69775A; Timer/Pacer, 69736A.
	 <p>Digital Output and Switching</p>	Sixteen-bits of data in TTL, open collector, or SPST relay-contact form provide digital control of instruments and indicators. AC power, up to 6 Amps, can be switched to 12 loads with a 69731B, and 14570A AC Power Controller.	Digital Output, 69731B; Relay Output, 69730A; AC Power Controller, 14570A.
C O N T R O L	 <p>Digital Input</p>	Digital input cards accept 16-bits of data from digital measuring instruments, push-buttons, switches, relays, and other digital devices in the form of logic levels or contact closures. Digital data sources with more than 16-bits of data use several digital input cards.	Digital Input, 69771A; Isolated Digital Input, 69770A.
	 <p>Stepping Motor Control</p>	The Stepping Motor card can produce from 1 to 32767 pulses at either of two outputs (CW or CCW) to control motor translators. Output pulses are also used for pulse-train update of supervisory control stations. The pulse rate (motor speed) is also programmable.	Pulse Train/Stepping Motor, 69735A.
	 <p>Time and Frequency Reference</p>	Crystal controlled timing pulses, programmable from 1 μs to 18 hours, may be used as a time-base reference for control, measurement, and data acquisition. Period, duty cycle, and number of pulses are all programmable.	Timer, 69736A or Pulse Train, 69735A.
	 <p>Level Detecting</p>	When signals cross preset levels, the Digital Input card can trigger the interrupt card to interrupt the computer. The alarm trigger levels can be programmed with the D/A or fixed with resistors.	Digital Input 69771A; Interrupt card, 69776A.
A L A R M	 <p>Event Sensing</p>	A digital word may be used to trigger quick computer response with the interrupt card. The computer responds to the interrupt with a software routine. The interrupt may also cause immediate local response by triggering a preloaded output card.	Interrupt card, 69776A.

New Multiprogrammer plug-in cards are being developed. Ask your HP Field Sales Engineer for the latest technical data describing all Multiprogrammer products.



69752A 64 Channel FET Scanner Card

Scans 64 single-ended channels (± 10.24 V input signal range) at up to 25,000 readings per second. Cards cascable to 960 channels in a single mainframe.

69755A 16 Channel FET Scanner Card

Same as 69752A, except scans 16 channels.

69754A 32 Channel Relay Scanner Card

Scans 32 single-ended (16 double-ended) channels with a ± 100 V input signal range at speeds up to 1000 readings per second (625 readings double-ended). Switches currents up to 50 mA.

69750A Scan Control/Pacer Card

Provides all pacing and control functions for the scanner cards listed above. One required for each group of scanner cards (maximum of 15 cards—see data sheet for further clarification).

69709A Power Supply Control Card

Used for full system control of 6024A and 6012A Autorange Power Supplies.

14728A Buffered A/D Cable

Used to connect 69751A and 69790B in a buffered A/D configuration.

69700A-69706A Resistance output cards: the output of each of these cards is a programmable resistance value. Twelve mercury wetted relay contacts close across binary weighted precision resistors in a series string. The cards are designed to program the voltage or current output of an HP power supply with option 040.

69720A D/A voltage converter card: provides a high speed, bipolar output voltage programmable from -10.240 V to $+10.235$ V up to 5 mA load current.

69721A D/A current converter card: provides a bipolar -20.480 mA to $+20.475$ mA current output.

69730A Relay output card: provides sixteen independent, normally open, mercury wetted relay contacts. Contacts rated at 100 Vdc; or 1 Amp; and 28 VA.

69731B Digital output card: provides sixteen TTL or CMOS compatible outputs, or sixteen 100 mA open-collector switches.

69735A Pulse train output/stepping motor control card: generates up to 32767 pulses at a programmable frequency.

69736A Timer/pacer card: outputs a programmable pulse from one microsecond to eighteen hours or a programmable square wave.

69751A A/D converter card: this card measures bipolar dc voltages in one of four ranges, ± 100 mV, ± 1 V, ± 10 V, or ± 100 V, with 12 bit resolution at up to 33,000 readings per second.

69770A Isolated digital input card: breaks the path of potential ground loops with an optically coupled isolator in each of the sixteen digital input lines.

69771A Digital input/analog comparator card: monitors up to sixteen contact closures, switches, TTL signals, CMOS signals, or analog signals. The switching threshold can be set to any value between ± 9.5 volts by a screwdriver-adjustable potentiometer on the card or may be externally programmed.

69775A Counter/totalizer card: counts contact closures, TTL or CMOS logic level pulses, or analog waveform transitions in the range of 0 to 65,535.

69776A Interrupt card: compares up to sixteen logic level or contact closure inputs with a sixteen-bit reference word and interrupts for =, \neq , <, > conditions.

69790B Memory card (occupies 2 I/O slots): provides 4096 16-bit words for use with the DAC cards or the ADC cards or for other input/output tasks that need to run independent of other Multiprogrammer or computer tasks. Several Memory cards may be used to implement truly simultaneous operations.

69793A Breadboard card: the generalized grid area on this card may be used for mounting custom circuits.

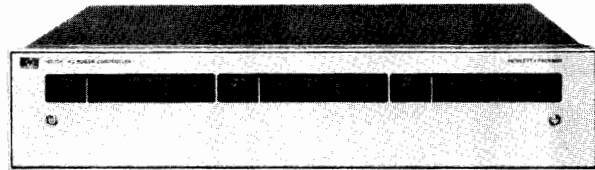

14570A AC Power Controller

- 12 AC Power Switches
- Switches up to 6 Amps RMS
- Low Noise
- Handles Inductive Loads
- True Zero-Crossing Switching
- Short Circuit Protections
- 115 and 230 Volt AC Outputs
- Rated for 2 Million Operations
- Quick Disconnect AC Plugs
- Designed to Meet UL, IEC & CSA
- 6940B, 6942A or TTL Control
- AC Line Filtering

The 14570A is a high reliability and low EMI alternative to using relays or conventional solid-state switches to control AC power. Up to 12 AC loads can be switched under computer control. Both 115 and 230 Vac loads of up to 6 amps can be controlled from a single unit. Primary uses include switching AC power on and off to instruments, power supplies, motors, and devices under test. It is also useful for burn-in, power cycling, and process control applications.

The AC outputs are organized into three groups of four switches. Each group has a single AC power input of either 115 or 230 Vac, which is distributed to four output connectors. Any switch can control up to 6 Amps, but each group of four switches is limited to a total of 15 Amps.

The unit is controlled by 12 TTL compatible lines, which can be driven by a Multiprogrammer Digital Output Card or a similar data source. Six additional lines allow system control. Each switch consists of a relay and a SCR in parallel. This approach to switching AC power offers a number of benefits over using relays or conventional solid-state switches. It features both the zero-crossing characteristics of a solid-state switch and the low power dissipation of a relay.

Unlike conventional solid-state switches, the 14570A is noise-free while a switch is closed, and it generates less EMI upon opening and closing than either a solid-state switch or relay. It also has a longer lifetime than these devices. The 14570A switches are rated at 2 million operations when switching 6 Amps, and at 10 million operations when switching 2 Amps.

The 14570A can handle most types of loads, including inductive loads such as motors. A complete description is given in the Multiprogrammer Series II I/O Cards data sheet (5952-4090).

Specifications

Line voltage: 115 or 230 Vac, +15%, -22%

Line frequency: 47 to 63 Hz

Isolation voltage: 1500 Vac rms

Maximum current (rms): up to 6 Amps per switch (at any lagging power factor*), with each group of 4 switches limited to 15 Amps.

*Loads with a leading power factor, such as power factor correction capacitors, should not be switched with the 14570A.

Maximum current (peak): 100 Amps per switch for less than 1 ms (non-repetitive). 20 Amps per switch continuously, subject to rms limitations.

Minimum load current: 20 mA

Off-state leakage: 2 mA through the external load

Maximum switching rate: 0.5 Hz

Turn-On delay: 6 to 30 ms. Turns on at zero voltage.

Turn-Off delay: 14 to 34 ms. Turns off at zero current.

Input characteristics: 1 k Ω pull-up resistors to +5 V

Logic High Level (Off) = 3.5 to 5.25 V

Logic Low Level (On) = -0.5 to 1.50 V

Required drive: negative-true, open collector; 5 mA maximum current sink at logic low level

Dimensions: 80 mm x 425 mm (3 1/2" x 16 3/4" x 16 3/4")

Weight: 9.5 kg (21 lbs)

14570A Options

040: 69331B card & cable for use with 6940B

042: 69731B card & cable for use with 6942A

050: Undertermined cable for use with other sources

14570A AC Power Controller

DATA ACQUISITION, CONTROL & TEST

Multiprogrammer: Versatile Automatic Test, Data Acquisition and Control

Model 6940B

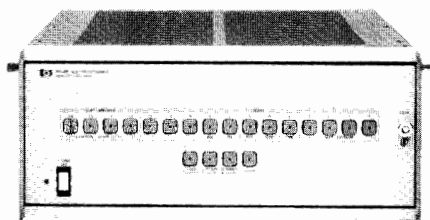

- Stimulus
- Measurement
- Control
- Data acquisition

Multiprogrammer I/O Card Function

	Functions	Applications	Cards Used
STIMULUS	<p>Programmable DC Voltage and Current</p>	The output voltage (up to 100V) and current (up to 1000A) of thirty-seven different HP power supplies can be programmed to provide bias in automatic test systems or control of electromechanical process equipment.	Resistance Output, 69501A-69513A; Power Supply Control, 69520A.
	<p>Digital-to-Analog Conversion</p>	Twelve bit voltage and current DAC's for strip chart, x-y, and analog tape recordings as well as control of analog programmable instruments and process control devices with 0-5 volt or 4-20 mA inputs.	Quad DAC, 69322A; Voltage DAC, 69321B; Current DAC, 69370A; Regulator, 69351C
	<p>Time and Frequency Reference</p>	Fully programmable, crystal-controlled time base generates one shot pulses from 1 μ s to 34 minutes in duration, or continuous pulse trains in the frequency range from 244 μ Hz to 500 kHz. Used to pace A/D and scanning measurements, and as a general purpose time base.	Time/Pacer, 69602A.
MEASUREMENT	<p>Voltage, Current, Resistance and Temperature Measurements</p>	High speed A/D measures voltages in the presence of 100 V of common mode noise. Connecting a resistor across the input permits current measurements for 4-20 mA current loops used in process control. Combine A/D and current DAC cards for resistance measurements. Low level A/D measures 6 channels of temperature.	High Speed A/D, 69422A; Current DAC, 69370A; Regulator, 69351C; Low Level A/D, 69423A.
	<p>Frequency Measurements</p>	The pulse counter card accumulates counts over a precise time interval when a programmable timer card is connected to the enable line of the counter. The program divides the count by the time interval to measure the frequencies from 200 kHz to 0.001 Hz.	Pulse Counter, 69435A; Timer/Pacer, 69602A.
	<p>Pulse Counting Preset Up/Down</p>	Counter may be preset to any value within count range of 0 to 4095. The program can examine the counter without disturbing the counting process (read-on-the-fly).	Pulse Counter, 69435A.
	<p>Time Interval Measurement</p>	Elapsed time between two events can be measured in the range of 10 μ s to 1 hour by counting a known frequency over the unknown interval. The program divides the accumulated count by the known frequency to determine the interval.	Pulse Counter, 69435A; Timer/Pacer, 69602A
CONTROL	<p>Stepping Motor Control</p>	One output word to card produces from 1 to 2047 square-wave pulses at either of two outputs (CW or CCW) to control motor translators. Output pulses are also used for pulse train update of supervisory control stations.	Stepping Motor Control, 69335A.
	<p>Digital Output and Switching</p>	Twelve bits of data in TTL, open collector, or SPST relay-contact form provide digital control of instruments and indicators. AC power, up to 6 Amps, can be switched to 12 loads with a 69331B and 14570A AC Power Controller.	TTL, 69331B; Open Collector, 69332A; Relay Out, 69330A; Relay Out/Readback, 69433A; AC Power Controller, 14570A.
ACQUISITION	<p>Scanning and Input Multiplexing</p>	The High Speed FET Scanner Card acts as an input multiplexer for the High Speed A/D. Single-ended voltages can be read at rates of up to 20,000 channels per second. Relay cards can also be used to multiplex double-ended signals at slower rates.	High Speed Scanner Card, 69336B; Relay/Readback, 69433A.
	<p>Event Sensing</p>	It is often necessary for a system to respond quickly to alarm conditions, operator intervention or other requests for immediate service. This service request is made via a program interrupt generated by either an event sense or a process interrupt card.	Event Sense, 69434A; Process Interrupt, 69436A.
	<p>Digital Input</p>	Digital input cards accept 12 bits of data from digital measuring instruments, push buttons, switches, relays and other digital devices in the form of logic levels or contact closures. Digital data sources with more than 12 bits of data use several digital input cards.	Digital Input, 69431A; Isolated Digital Input, 69430A.

Ask your HP Field Sales Engineer for the latest technical data describing all Multiprogrammer products.



6940B Multiprogrammer

The 6940B Multiprogrammer provides a convenient way to interface a variety of analog and digital signals to a computer. Its flexibility, inherent in its card cage design, makes it suitable for a wide range of high speed automatic test, data acquisition and control applications.

Performance

The performance of the 6940B Multiprogrammer is highly dependent upon the computer used to control it. In addition, the method used to interface the computer, either HP-IB or 16-bit duplex, has an effect upon system performance. Typical execution times for each of the supported computers and interfaces are listed in the 6940B Multiprogrammer data sheet (HP p/n 5952-4077).

Supported Computers and Documentation Options

A number of HP computers, fitting a wide range of user needs, can control the 6940B. Supported computers include the Series 200 (9816, 9826, and 9836), the Series 80 (HP-85, 86, 87 and 9915A), Series 1000 (E, F, and M), and the 9825 and 9845 computers. These computers are described in greater detail elsewhere in this catalog. 6940B programming information is obtained for each computer by specifying the appropriate documentation option with each 6940B order.

HP-IB or GPIO Interface?

The 6940B GPIO interface is generally faster than the HP-IB interface, and is necessary to obtain the maximum data transfer rate. The HP-IB interface is useful when maximum speed is not required, and a computer I/O slot is unavailable to add a GPIO interface. The cost of each interfacing method also varies from computer to computer.

14558A Termination Panel facilitates field wiring to the I/O cards. Used in conjunction with the 14560A, 14561A and 14562A cables, it brings the edge connections of the I/O cards out to a 19-inch rack mounting screw terminal barrier strip.

Condensed Specifications

6940B/6941B Common Specifications

Input/output card positions: maximum of 15 plug-in input or output cards per mainframe. Hinged front panel provides access.

Mainframe data connectors: two 50-contact, ribbon connectors.

Data transfer rate: up to 20,000 words/second.

Maximum data resolution: 12 bits per plug-in card.

Accessories furnished: Data Input Plug, PC Board Extender Card.

Cooling: natural convection.

Temperature: 0°C to 55°C operating, -40°C to +75°C storage.

Size: 172.2 H x 425.4 W x 539.8 mm D (6.78" x 16.75" x 21.25").

Power: 100/120/220/240 VAC selectable, 48-440 Hz, 230 watts.

6940B Specifications

Front panel controls: power ON/OFF switch and indicator lamp, REMOTE/LOCAL switch for selecting computer or manual control, 19 switches for manual data entry and control.

Weight: net, 15.9 kg (35 lb). Shipping, 19.5 kg (43 lb).

6941B Specifications

Front panel controls: power ON/OFF switch and indicator lamp.

Weight: net, 15.2 kg (33.5 lb). Shipping, 18.3 kg (40.3 lb).

59500A HP-IB Interface Unit Specifications

Converts the serial ASCII alphanumeric of the HP-IB to the 16-bit parallel format required by the 6940B/6941B Multiprogrammer. The 59500A design is optimized for ease of programming the 6940B/6941B.

Front panel controls: power ON/OFF switch and indicator. LED's indicate mode and gate/flag status between HP-IB and the Multiprogrammer for system check-out and maintenance.

Cooling: natural convection.

Temperature: 0°C to 55°C operating; -40°C to +75°C storage.

Size: 82.6 H x 425.4 W x 463.6 mm D (3.25" x 16.75" x 18.25").

Weight: 5.4 kg (12 lb).

Power: 100/120/220/240 VAC (selectable) 48-440 Hz, 15 W.

Ordering Information

Each 6940B can hold up to 15 I/O cards and a 69351C.

Each 6941B can hold up to 15 additional cards.

Select:

- A computer and any I/O ROMs necessary.
- One documentation option (required with 6940B order).
- HP-IB or GPIO interface products for the computer.
- All I/O cards required.
- One 14541A chaining cable for each 6941B ordered.

	I/O ROM req.	Documentation Option #	HP-IB					GP-IO			
			59500A	82937A	98034B	59310B	HP-IB Cable	6940B, Opt 185	98032A, Opt 040	98622A, Opt 003	14550B
85A	X	★	X	X				X			
86, 87	X	★	X	X				X			
9915A		★	X	X				X			
9816		016	X				X			X	
9825	X	025	X		X				X		
9826		026	X				X			X	
9836		036	X				X			X	
9845	X	045	X		X				X		
HP-1000		010	X			X					X

★HP-IB documentation: Opt. 085

GP-IO documentation & interface: Opt. 185

Options

Option 010-136: One Set Documentation

Option 185: Series 80 16-bit Duplex Interface

Option 410-536: Extra Documentation

Programmable Plug-In Cards

Output Cards

- 69500A-69506A Resistance Output Cards
- 69510A-69513A Resistance Output Cards
- 69520A Power Supply Programming Card
- 69321B Voltage D/A Converter Card
- 69322A Quad D/A Voltage Converter Card
- 69330A Relay Output Card
- 69433A Relay Output/Readback Card
- 69331B Digital Output Card
- 69332A Open Collector Output Card
- 69335A Stepping Motor Control Card
- 69370A Current D/A Converter Card
- 69380A Breadboard Output Card
- 69602A Timer/Pacer Card

Input Cards

- 69336B High Speed Scanner Card
- 69422A High Speed A/D Converter Card
- 69423A Low Level A/D Converter Card
- 69431A Digital Input Card
- 69430A Isolated Digital Input Card
- 69434A Event Sense Card
- 69435A Pulse Counter Card
- 69436A Process Interrupt Card
- 69480A Breadboard Input Card

Other Cards & Accessories

- 69280A Breadboard Card
- 69351C Voltage Regulator Card
- 14541A Chaining Cable
- 14550B Computer Interface Kit
- 14551A Service Kit

59500A HP-IB Interface Unit

6940B Multiprogrammer

6941B Multiprogrammer Extender

DATA ACQUISITION, CONTROL & TEST

Multiprogrammer Training and Support

Application Notes

A new series of application notes introduces a beginner to Computer Aided Test, and makes it easier for any user to implement four of the most popular 6942A configurations, such as waveform digitization, illustrated below. Each of the latter four notes contains a comprehensive study of an application, and includes theory, wiring information, and software listings for the basic functions. Information on advanced techniques is also provided. Although the programming information is oriented toward the HP 9826A and 9836A computers, the concepts are discussed in a general way that allows application to other computers. Copies of these application notes are available through your local HP office.

AN316-0 Introduction to Computer Aided Test

This introductory note is designed to take a CAT novice through the steps of evaluating, planning, and implementing a sample CAT system.

AN316-1 Buffered Analog-to-Digital Conversion

A buffered A/D allows the 6942A to acquire data rapidly, and store it without computer intervention. Additional buffered A/D's can be used to make measurements simultaneously from many channels. This note describes how to configure the 69751A A/D Converter and the 69790B Memory card with the 14728A cable set for these capabilities.

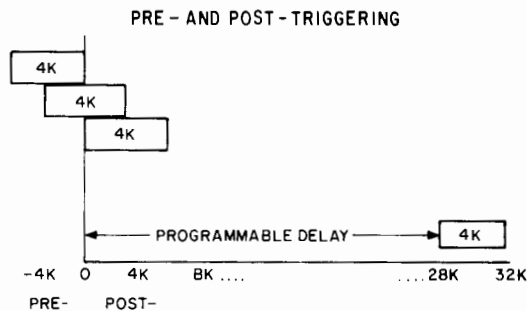

AN316-2 Waveform Digitization

The 6942A can also function as a logic analyzer for analog signals. As shown above, it can store a block of 4096 voltage readings occurring before, during or after an external event. This capability makes the 6942A useful for digitizing transients, and recording events with long propagation delays.

AN316-3 High Speed FET Scanning

High speed data acquisition from many channels is easily accomplished with the Multiprogrammer scanner system consisting of a 69750A Scan Control/Pacer card and one or more 69752A, 69754A or 69755A Scanner cards. This note covers sequential and random access scanning methods.

AN316-4 Power Supply Programming

Full system control of a power supply—including output voltage and current readback—is possible with a single Multiprogrammer card. The 69709A Power Supply Control card is designed for control of 6024A and 6012A power supplies equipped with Option 002.

Product Notes

A series of Product Notes is available for the Multiprogrammers. The first two, 6940B-1 and 6940B-2, are product oriented, and describe how to use particular Multiprogrammer cards. The others are Product "Application Stories" which describe how Multiprogrammer customers have implemented specific applications.

6940B-1 "Scanning with the 6940B Multiprogrammer" Describes use of 69336B FET Scanning card for high speed data acquisition.

6940B-2 "Power Supply Control" Describes use of 69520A card to control HP Autoranging power supplies.

6940B-3 "Subassembly Testing" Ford's Flexible Electronic Test Set reduces cost and design times.

6940B-4 "Automating Manual Equipment" Radiation monitoring.

6940B-5 "Basic Research" Control of scanning Electron Microscope for use in Electron-Beam Lithography system.



6940B-6 "Product Evaluation" BF Goodrich tests tire traction.

6942A-1 "Production Line Testing" Hybrid device test system.

6942A-2 "Heavy Industry" Metal Pipe production linked to Inventory Control System.

6942A-3 "Instrument Control" Production Testing using automatic modem test system.

Multiprogrammer Training Course

The fastest way to learn to use the 6940B or 6942A Multiprogrammer is to enroll in the Multiprogrammer Training Course, given at various sites around the country. At the Multiprogrammer School you will receive three days of in-depth training from Multiprogrammer experts. The school also gives you the chance to ask the experts questions regarding your particular application. The school offers a hands-on approach to get you programming the multiprogrammer fast.



6940B and 6942A Service Kits

The HP 14711A Field Service Kit is a service aid for the HP 6942A Multiprogrammer. It provides board exchange capability for users with a need for the shortest possible downtime.

The 14711A case contains seven pretested mainframe PC assemblies which can replace defective PC assemblies in the 6942A. Twelve additional slots can be filled by the user with spare I/O cards.

Troubleshooting information needed to isolate a malfunctioning mainframe PC assembly can be found in HP 6942A Installation and Assembly Level Service Manual (HP P/N 06942-90006). Interpretation of errors reported by defective I/O cards can be found in Appendix B of the HP 6942 User's Guide.

Defective boards which are replaced by boards from the 14711A can be sent to the local HP Service Center for repair.

The HP Model 14551A Multiprogrammer Service Kit for the Hewlett-Packard Model 6940A/B Multiprogrammer subsystems is designed to be used with an HP computer in the HP 1000 series, a 9825A desktop computer, or by the 6940B operating alone in the LOCAL mode.

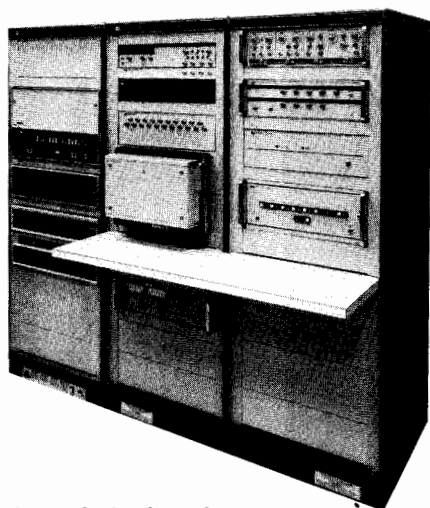

Customized automatic test systems,
integrated by Hewlett-Packard

Switches for Automatic Test

HP-IB switch products used in HP automatic test systems are available individually for HP 1000 system users who manufacture their systems in-house or those who have complex switching requirements in their HP 1000-based automated test systems. These switches provide a commercially-available solution for connecting the system to the unit-under-test (UUT). Three types of switching units are available, all controlled by a single 9411B Switch Controller that provides micro-processor control of multiple switch mainframes.

- **9411B Switch Controller**

The 9411B is for use on HP 1000 Computer Systems and is controlled via the HP-IB. It provides control logic and relay power for the switch mainframes. It performs comprehensive self-test and fault isolation of all signal relays in the 9412A and 9414A switch cards.

- **9412A Modular Switch**

Provides high-density, multi-function switching of signals up to 10 MHz. A built-in 1768-pin (34 x 52) matrix interface panel improves signal performance and eliminates "spider web" cabling. The 9412A accommodates five types of switch cards in any combination up to a total of 25 cards.

- **9413A VHF Switch**

Provides modular, flexible high-frequency switching of pulse and video signals up to 500 MHz. The 9413A accommodates up to 12 coaxial switch modules.

- **9414A Matrix Switch**

Provides maximum flexibility for switching signals up to 10 MHz. Designed for high-density, high-performance switching, the 9414A allows any UUT pin to be switched to any instrument in the system. The 16-input matrix can be configured in 30-pin increments (UUT pins) up to 120 pins. A distribution bus allows several instruments to share four of the 16 matrix inputs, thus minimizing switching requirements.

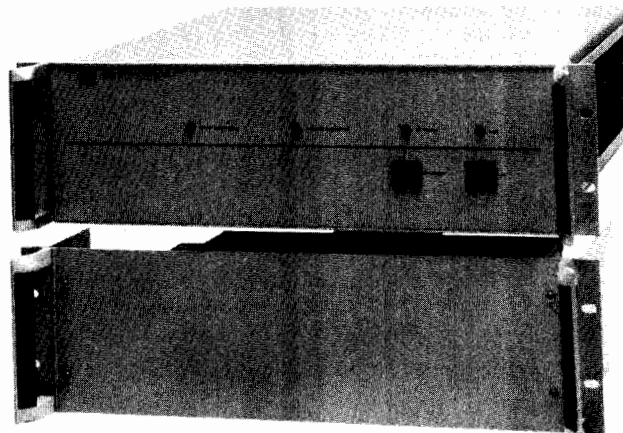

9411B Switch Controller

ATS/1000 Integration Services

Previously, when building an automatic test system, users had only two choices: purchase an already-assembled "turn-key" system or purchase computers and instruments separately and assemble them on their own. As a result of our experience with more than 1000 HP automatic test system installations worldwide, HP offers two categories of system-building assistance, called ATS/1000 Integration Services.

An automatic test system can be purchased at various levels of completion, depending on how much assistance the user desires. At the lowest level, called Racking and Cabling Service, HP consolidates the equipment, designs cabinet layout and power distribution, then installs the equipment in cabinets. The user assumes responsibility for software configuration and testing.

With the highest level of service, Configuration/System Test, the user receives a fully-integrated, fully-installed system, ready for developing application programs. HP consolidates the equipment, installs it in cabinets, configures the operating software, and checks out the system on-site.

Integration service prices vary, depending on the complexity and size of the system. A typical system that contains \$100,000 of instrumentation typically requires \$30,000 to \$40,000 of integration services to be fully configured and tested.

Ordering Information

93283A ATS Racking and Cabling Service

93284A ATS Configuration/System Test Service



AMPLIFIERS

Microwave Power Amplifier

Model 11975A

- 2 GHz to 8 GHz wideband frequency coverage
- 40 milliwatts (+16 dBm) output
- Adjustable, calibrated power level



11975A

Convenient Microwave Amplifier

The HP 11975A is a general purpose microwave amplifier which offers versatility, convenience, and reliability at an economical price. Combining state-of-the-art GaAs FET technology with a regulated power supply and control circuits makes this amplifier a complete tool for lab and production.

Broadband, Leveled Power

The amplifier delivers up to 40 milliwatts (+16 dBm) of leveled power for broadband input signals from 2 to 8 GHz. With ± 1 dB frequency response and ± 2 dB absolute power accuracy, the 11975A provides calibrated power for fixed or swept frequency needs.

Versatile Features

The 11975A has many features designed for general purpose use:
Automatic level control (ALC): output power is normally leveled unless the ALC switch (rear panel) is OFF or less than minimum input power required for leveling is available. An unlevelled light indicates the non-ALC condition.

Adjustable output power: calibrated output power can be adjusted from +6 to +16 dBm. An uncalibrated light indicates when greater than +16 dBm is present at the output connector.

Diode bias: positive or negative bias current needed for some harmonic mixers is provided by a separate connector and control knob.

Applications

- The 11975A supports many general purpose testing needs:
- As an LO booster and isolation amplifier, the 11975A improves mixer performance and testing.
 - As a pre-amplifier, the 11975A increases counter sensitivity and improves spectrum analyzer noise figure.
 - As an LO line driver for a harmonic mixer (such as an HP 11517A or HP 11970), the 11975A increases sensitivity, improves frequency response, and reduces gain compression.

Specifications

Frequency Specifications

Frequency range: 2.0 to 8.0 GHz in one band.

Output Specifications

Distortion

Harmonics (2nd and 3rd): < -20 dBc for $P_{out} \leq +16$ dBm.

Non-harmonics: < -60 dBc typical for $P_{out} \leq +16$ dBm.

Third order intercept (ALC OFF): +25 dBm typical.

1 dB gain compression (ALC OFF): +18 dBm typical.

Noise figure: 13 dB typical.

Output Power (ALC ON)

Power level control: single turn knob with 11 calibrated divisions in 1 dB steps; spring loaded detent for uncalibrated power above +16 dBm.

- Automatic level control
- Diode bias supply for harmonic mixers

Power range: +6 dBm to +16 dBm.

Absolute power accuracy: ± 2.0 dB; ± 1.5 dB typical.

Frequency response: ± 1.0 dB; ± 0.5 dB typical.

Uncalibrated power range: +16.75 dBm to +19 dBm typical; uncalibrated light warns of high level.

Reverse isolation: > 40 dB typical at +16 dBm output.

Output Connection

Connector: SMA female.

Impedance: 50 ohm nominal.

SWR: 1.7:1, ALC ON; 2.5:1 typical, ALC OFF.

Short circuit protection: continuous.

Input Specifications

Minimum input power: minimum power for leveling.

Small signal gain: gain with less than minimum input for leveling or with ALC switch OFF (rear panel).

Frequency	Minimum Input	Gain
2.0 GHz to 4.5 GHz	+2 dBm	15 dB
4.5 GHz to 6.1 GHz	+5 dBm	11 dB
6.1 GHz to 8.0 GHz	+8 dBm	9 dB

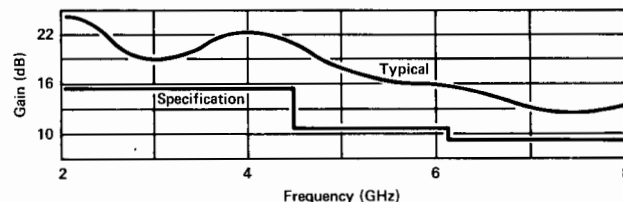

Small signal gain vs. frequency

Input Connection

Connector: SMA female.

Impedance: 50 ohm nominal.

SWR (ALC OFF): 2.7:1 typical.

Maximum input: = +30 dBm (1 watt); ± 35 Vdc.

Diode Bias Specifications

Bias control: five turn knob for positive and negative current adjustment with 10 μ A resolution.

Current range: 0 to ± 10 mA typical for single diode load.

Output Connection

Connector: BNC female.

Maximum voltage: ± 3 Vdc typical.

Short circuit protection: ≤ 10 mA typical.

General Specifications

Power requirements: 100, 120, 220, or 240 Vac (user selectable), +5%, -10%; 48 to 440 Hz; less than 36 VA; convection cooled.

Environmental: per MIL-T-28800C, Type III, Class 5, Style E.

Temperature: operating 0° to +55°C; storage -40° to +75°C.

EMI: conducted and radiated interferences are in compliance with methods CEO3 and REO2 of MIL STD 461A and CISPR Pub. 11 (1975).

Weight: net, 3.04 kg (6.8 lb). Shipping, 5.45 kg (12.2 lb).

Size: 102 H \times 213 W \times 297 mm D (4.0" \times 8.4" \times 11.7").

Ordering Information

11975A Amplifier

Opt 001: Type N Female Connectors

Opt 907: Front Handles

Opt 910: Extra Operating and Service Manual

Rack Mounting Kit: (P/N 5061-0072)

- Continuous 2 to 20 GHz coverage with 8349A
- 15 dB Gain with 8349A

- 100 milliwatts across full 8349A range
- 1 watt output with 400 series TWT

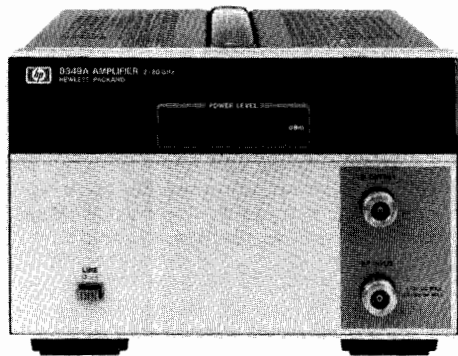

8349A

The HP 8349A Solid-state Amplifier and the HP 400 Series TWT Amplifiers deliver increased microwave power performance across a 2 to 20 GHz frequency range. These general-purpose broadband power amplifiers are designed for maximum reliability and configured for the greatest convenience in interfacing with Hewlett-Packard's microwave sources, namely, the 8350 or 8620C Sweep Oscillators, the 8340A Synthesized Sweeper, and the 8672A or 8673A Synthesized Signal Generators.

8349A Broadband Solid-State Amplifier (2–20 GHz)

Providing 100 milliwatts (20 dBm) of output power from 2 to 20 GHz, the 8349A is one of the most broadband solid-state power amplifiers available today. This general-purpose, broadband power performance is achieved using a GaAs FET design of multiple stages. This multiple stage design provides more than 15 dB of gain over the full 2 to 20 GHz range.

Externally leveled output power can also be provided by the 8349A without using an external coupler and detector, since these external leveling components are built-in and are compatible with Hewlett-Packard microwave sources. The 8349A is also equipped with an output power display. This display minimizes the need for an external power meter and enhances the amplifier's utility; for example, at the end of a long cable, where the microwave output needs to be amplified, leveled and measured.

Naturally, the versatile power control features of the microwave source (e.g., calibrated power, power sweep, power slope and remote power control via the Hewlett-Packard Interface Bus) can be accurately transmitted through the 8349A during external leveling operations.

8349A Amplifier Applications

The 8349A is an excellent power amplifier for microwave measurements in a versatile bench-top arrangement or in a dedicated rack-mount system.

The broadband power of the 8349A is also ideal for making antenna efficiency and antenna pattern measurements.

The 60 dB dynamic measurement range of the 8755C and 8756A Scalar Network Analyzers can be extended by >20 dB using the 8349A Amplifier.

High power pulse measurements (20 dBm output power, 80 dB on/off ratio, 25 ns rise and fall times) from 2 to 20 GHz can be achieved using the HP 8349A Amplifier and the HP 8340A Synthesized Sweeper or the HP 8673A Synthesized Signal Generator.

RFI susceptibility tests can also greatly benefit by the high quality amplifying characteristics of the 8349A.

8349A Specifications

Frequency range: 2.0 to 20 GHz.

Minimum power output (for 5 dBm input): 20 dBm (100 milliwatts).

Minimum gain (at 20 dBm output power): 15 dB.

Noise figure: <13 dB typical.

Input pulse rise/fall time: <10 ns typical.

Reverse isolation: >50 dB.

Maximum input power: 26 dBm.

Maximum dc input voltage: ±10V.

400 Series TWT Amplifiers (1.0–12.4 GHz)

One watt of output power with 30 dB of gain from 1.0 to 12.4 GHz make the HP 400 series of TWT amplifiers important building blocks for many microwave measurement systems. This high-power performance is delivered by four separate TWT amplifier models; each covering approximately an octave bandwidth.

All four TWT amplifiers provide dc-coupled amplitude modulation capabilities for externally leveled power operation and for modulation drive signals from dc to 50 kHz. A front panel CATHODE CURRENT meter and gain control knob also monitor and reduce tube current for extended tube life.

400 Series Specifications

Minimum power output (for 1 dBm input): 30 dBm (1 watt).

Minimum gain (at 30 dBm output power): 30 dB.

Noise figure: ≤30 dB.

Amplitude Modulation

Sensitivity: modulation input of >−20V peak reduces RF output by ≥20 dB from dc to 50 kHz.

Frequency response: dc to 500 kHz (typical 3 dB bandwidth).

Input pulse rise/fall time: <1 us.

	489A	491C	493A	495A
Frequency range (GHz)	1–2	2–4	4–8	7–12.4
Gain variation with freq. At rated output:	≤6 dB	≤6 dB	≤6 dB	≤6 dB
Small signal: Across any 10% of band	≤5 dB	≤5 dB	≤5 dB	≤5 dB for 300 MHz
Across full band	≤12 dB	≤12 dB	≤12 dB	≤12 dB

General

Input/Output

50 Ω nominal impedance.

Type N female connectors.

Size

133 H x 214 W x 348 mm D, (5.2" x 8.36" x 13.6") for 8349A.

133 H x 426 W x 467 mm D, (5.2" x 16.75" x 18.38") for 400 series.

Weight

Net, 7 kg (15 lb). Shipping 14 kg (31 lb) for 8349A.

Net, 18 kg (40 lb). Shipping 23.9 kg (53 lb) for 400 series.

Ordering Information

8349A 2 to 20 GHz Solid-state Amplifier

Opt 001 Rear Panel RF Input/Output

Opt 002 Rear Panel RF Input with Front Panel RF Output

489A 1 to 2 GHz TWT Amplifier

491C 2 to 4 GHz TWT Amplifier

493A 4 to 8 GHz TWT Amplifier

495A 7 to 12.4 GHz TWT Amplifier

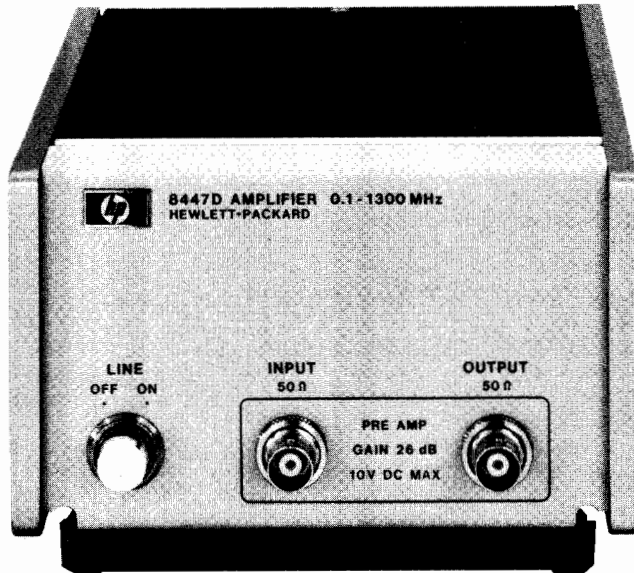

- Wide band
- Flat response
- Low noise

**8447D**

The HP 8447 series of general purpose amplifiers offers high reliability in the convenience of a small, lightweight package.

High Performance

These low noise, high gain, amplifiers provide the flat frequency response and low distortion required for a wide range of uses: to im-

prove the sensitivity of counters, spectrum analyzers, RF voltmeters, EMI meters, power meters and other devices; to increase the maximum power available from a signal generator or sweeper.

Broadband Frequency Coverage

The 8447 series offers an amplifier for nearly every application in the 100 kHz to 1.3 GHz frequency range. The amplifiers' wide bandwidths are compatible with other wideband instruments used for making measurements involving broadband spectra.

Options

A variety of options are available: Option 001 and Option 011 are dual channel versions with BNC and Type N connectors respectively for operation with dual channel systems such as oscilloscopes or network analyzers (or the channels may be cascaded for increased gain). Option 010 provides Type N connectors rather than the standard BNC connectors for the single channel amplifiers.

General

Weight: net, 1.56 kg (3.4 lb). Shipping, 2.30 kg (5.1 lb).

Size: 85.8 H x 130 W x 216 mm D (3.4" x 5.1" x 8.5").

Power requirements: 110 or 230 V ac \pm 10%, 48-440 Hz, 15 watts.

Ordering Information

8447A Preamp

Opt 910: Extra Operating and Service Manual (8447A)

8447D Preamp

8447E Power Amp

8447F Preamp-Power Amp

Opt 910: Extra Operating and Service Manual (8447D/E/F)

Specifications

	8447A Preamp	8447D Preamp	8447E Power Amp	8447F Preamp-Power Amp
Frequency Range	0.1-400 MHz	100 kHz-1.3 GHz	100 kHz-1.3 GHz	100 kHz-1.3 GHz
Typical 3 dB Bandwidth	50 kHz-700 MHz	50 kHz-1.4 GHz	50 kHz-1.4 GHz	50 kHz-1.4 GHz
Gain (Mean)	20 dB \pm 0.5 dB at 10 MHz	>26 dB (20°C-30°C)	22 dB \pm 1.5 dB (20°C-30°C)	
Gain Flatness Across Full Frequency Range	\pm 0.5 dB	\pm 1.5 dB	\pm 1.5 dB	
Noise Figure	<5 dB	<8.5 dB	<11 dB typical	
Output Power for 1 dB Gain Compression	>+6 dBm	>+7 dBm typical	>+15 dBm	
Harmonic Distortion	-32 dB for 0 dBm output	-30 dB for 0 dBm output (typical)	-30 dB for +10 dBm output	
Typical Output for <-60 dB Harmonic Distortion	-25 dBm	-30 dBm	-20 dBm	
VSWR	<1.7	<2.0 input <2.2 output 1-1300 MHz	<2.2 1-1300 MHz	
Impedance	50 Ω	50 Ω	50 Ω	
Reverse Isolation	>30 dB	>40 dB	>40 dB	
Maximum DC Voltage Input	\pm 10 V	\pm 10 V	\pm 10 V	
Options Available	001	001, 010, 011	010	010

1 8447D AND 8447E COMBINED IN A SINGLE PACKAGE

Selecting An Analog Voltmeter

Analog Voltmeters are used for many applications from general purpose bench or field use to special needs of true rms ac detection.

For measurements involving dc applications, select the instrument with the broadest capability meeting your requirements. For ac measurements involving sine waves with only modest amounts of distortion (<10%), the average-responding voltmeter can perform over a bandwidth extending to several megahertz. For high-frequency measurements (>10 MHz), the peak-responding voltmeter with the diode-probe input is the most economical choice. Peak-responding circuits are acceptable if inaccuracies caused by distortion in the input waveform can be tolerated. For measurements where it is important to determine the effective power of waveforms that depart from a true sinusoidal form, the True RMS-responding voltmeter is the appropriate choice.

Some analog voltmeters offer multiple functions such as dc and ac voltage plus resistance measurements.

Analog Voltmeter Accuracy

Before we can discuss meter accuracy, we must have a familiarity with the various meter scales available. Many instruments have meter scales marked in both volts and decibel (dB) units. It should be noted that dB and

voltage are complements of each other. That is, if a voltage scale is made linear, the dB scale on the same meter face will be logarithmic or nonlinear. Likewise, if the dB scale is made linear, the voltage scale becomes nonlinear. The term "linear-log scale" is applied to an instrument that has a linear dB scale and, therefore, a nonlinear voltage scale. Several different types of meter faces are illustrated in Figure 1.

Analog meters usually have nonlinearities and/or offsets present in the attenuators and amplifiers. The meter movement itself can have nonlinearities even with individually calibrated meter scales. Nonlinearities cause percent of reading errors, and offsets cause percent of full scale errors.

Looking at instrument specification sheets, accuracy specifications are usually expressed in one of three ways: 1. percent of the full-scale value, 2. percent of the reading, 3. (percent of reading + percent of full-scale). The first is probably the most commonly used accuracy specification. The second (percent of reading) is more commonly applied to meters having a logarithmic scale. The last method has been used more recently to obtain a tighter accuracy specification on a linear-scale instrument.

Hewlett-Packard uses the two-part accuracy specification to take advantage of the upper-scale accuracy and yet maintain a reasonable specification for the lower portion of the scale.

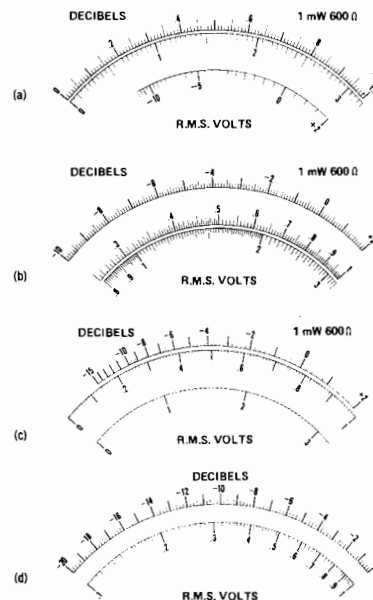

Figure 1. Four different types of meter scales available. (a) Linear 0-3 V and 0-10 V scales plus a dB scale. (b) Linear dB scale plus non-linear (logarithmic) voltage scales. (c) dB scale placed on larger arc for greater resolution. (d) Linear -20 to 0 dB scale useful for acoustical and communications applications.

Analog Voltmeter Selection Chart

Model	AC VOLTMETERS	Voltage Range	Frequency Range; Typical Accuracy	Page
3400A	RMS VOLTMETER provides rms readings of complex signals. Has dc output for driving DVM's or recorders	1 mV to 300 V (12 ranges)	10 Hz to 10 MHz ±1% to ±5%	76
400E 400 EL	HIGH ACCURACY AC VOLTMETER has dc output (±0.5%) for driving recorder	1 mV to 300 V; -60 dB to +50 dB	10 Hz to 10 MHz ±1% ±5%	77
400F 400 FL	FAST-RESPONSE AC VOLTMETER 100 kHz low-pass filter ac amplifier	100 μV to 300 V; -80 dB to +50 dB	20 Hz to 4 MHz; ±1% to ±4%	77
400GL	HIGH ACCURACY dB VOLTMETER 20 dB log scale (0 dB = 1 V)	-80 dB to +60 dB (8 ranges)	20 Hz to 4 MHz; ±0.2 dB to 0.4 dB	77
3406A	SAMPLING RF VOLTMETER provides True RMS measurements when used with 3400A. Many accessories	1 mV to 3 V (8 ranges)	10 kHz to >1.2 GHz ±3% to ±13%	81
Model	MULTI-FUNCTION METERS	Voltage Range (Accuracy)	Resistance Range (Accuracy)	Page
427A	BATTERY-OPERATED MULTI-FUNCTION METER has 10 MΩ dc input impedance and 10 MΩ/20 pF ac input impedance	dc: ±100 mV to 1000 V (±2%) 9 ranges ac: 10 mV to 300 V 10 Hz to 1 MHz (±2%) 10 ranges	10 Ω to 10 MΩ mid-scale ±5%; from 0.3 to 3 on the meter scale (7 ranges)	79
410C	VERSATILE VOLTMETER has 100 MΩ dc input impedance and 10 MΩ/1.5 pF ac impedance	dc: ±15 mV to ±1500 V (±2%) 11 ranges ac: 0.5 V to 300 V 20 Hz to >700 MHz (±3% at 400 Hz) 7 ranges	10 Ω to 10 MΩ (center scale) 0 to mid-scale: ±5% or ±2% of mid-scale (whichever is greater) 11 ranges current: dc: ±1.5 μA to ±150 mA (±3%)	78
Model	CURRENT METERS	Current Range	Frequency Range	Page
428B	dc MILLIAMMETER with clip-on probe eliminates direct connection	1 mA to 10 A FS (9 ranges)	dc to 400 Hz	80

ANALOG VOLTMETERS

10 Hz to 10 MHz True RMS Voltmeter

Model 3400A

- 10 MHz bandwidth
- High crest factor for accurate pulse measurements
- Stable, linear dc output

- 1 mV full-scale sensitivity
- 10 MΩ input impedance
- Taut-band individually calibrated meter

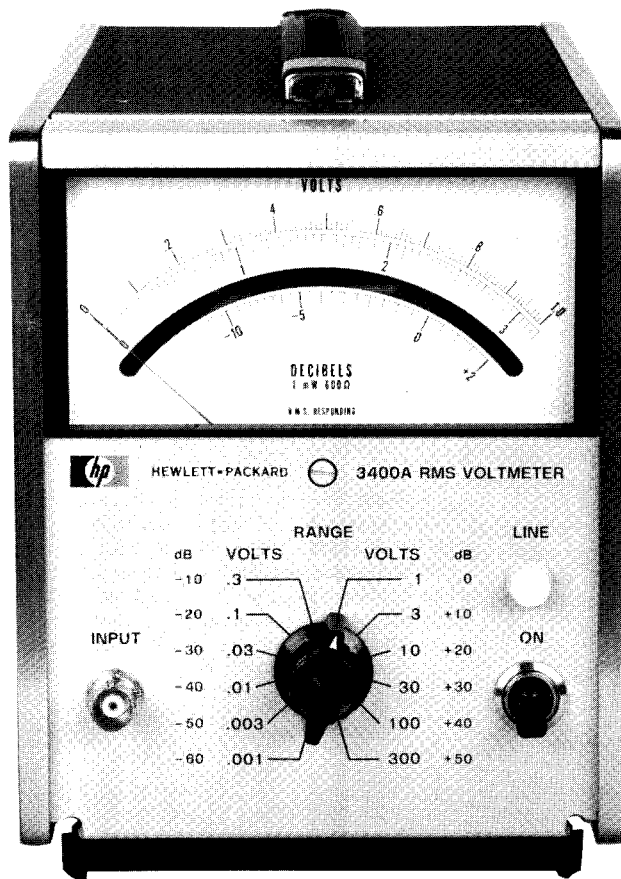

Description

The Hewlett-Packard Model 3400A is a true root-mean-square (rms) voltmeter, providing a meter indication proportional to the dc heating power of the input waveform.

Six-decade frequency coverage makes the 3400A extremely flexible for all audio and most RF measurements and permits the measurement of broadband noise and fast-rise pulses.

Pulses or other non-sinusoids with crest factors (ratio of peak to rms) up to 10:1 can be measured full scale. Crest factor is inversely proportional to meter deflection, permitting up to 100:1 crest factor at 10% of full scale.

Permanent plots of measured data and higher resolution measurements can be obtained by connecting an X-Y plotter, strip chart recorder or digital voltmeter to the convenient rear-panel dc output. The dc output provides a linear 0 to 1 volt drive proportional to meter deflection.

Specifications

Voltage range: 1 mV to 300 V full scale, 12 ranges.

dB range: -72 to +52 dBm (0 dBm = 1 mW into 600Ω).

Frequency range: 10 Hz to 10 MHz.

Response: responds to rms value (heating value) of the input signal for all waveforms.

Meter accuracy: % of full scale (20°C to 30°C)*

10Hz	50Hz	1MHz	2MHz	3MHz	10MHz
±5%	±1%	±2%	±3%	±3%	±5%

AC-to-DC converter accuracy: % of full scale (20°C to 30°C)*

10Hz	50Hz	1MHz	2MHz	3MHz	10MHz
±5%	±0.75%	±2%	±3%	±3%	±5%

* TC: ±0.1% from 0°C to 20°C and 30°C to 55°C.

Crest factor: (ratio of peak to rms amplitude of input signal): 10 to 1 at full scale (except where limited by maximum input) inversely proportional to meter deflection (e.g., 20 to 1 at half-scale, 100 to 1 at tenth scale).

Maximum continuous input voltage: 500 V ac peak at 1 kHz on all ranges; 600 V dc on all ranges.

Input impedance: from 0.001 V to 0.3 V range: 10 MΩ shunted by <50 pF. From 1.0 V to 300 V range: 10 MΩ shunted by <20 pF. ac coupled input.

Response time: for a step function, <5 s to final value.

AC overload: 30 dB above full scale or 800 V p, whichever is less, on each range.

Output: negative 1 V dc into open circuit at full-scale deflection, proportional to meter deflection from 10–100% of full scale. 1 mA maximum; nominal source impedance is 1000Ω. Output noise <1 mV rms.

Power: 115 or 230 V ±10%, 48 to 66 Hz, 15 VA max.

Size: 159 H (without removable feet) x 130 W x 279 mm D (6.25" x 5.1" x 11"); ½ module.

Weight: net, 3.3 kg (7.3 lb). Shipping, 4.5 kg (10 lb).

Accessories furnished: 10110A Adapter, BNC to dual banana jack.

Accessories Available

11170A Cable, 12 in., male BNC connectors

11170B Cable, 24 in., male BNC connectors

11170C Cable, 48 in., male BNC connectors

11002A Test lead, dual banana plug to alligator clips

11003A Test Leads, dual banana plug to probe and alligator clip

11076A Carrying Case

Ordering Information

3400A Opt 001 spreads out the dB scale by making it the top scale of the meter.

Rear terminals in parallel with front panel terminals and linear log scale uppermost on the meter face are available on special order.

3400A RMS Voltmeter

ANALOG VOLTMETERS

AC Voltmeter, 10 Hz to 10 MHz

Models 400E, EL, F, FL, GL

77

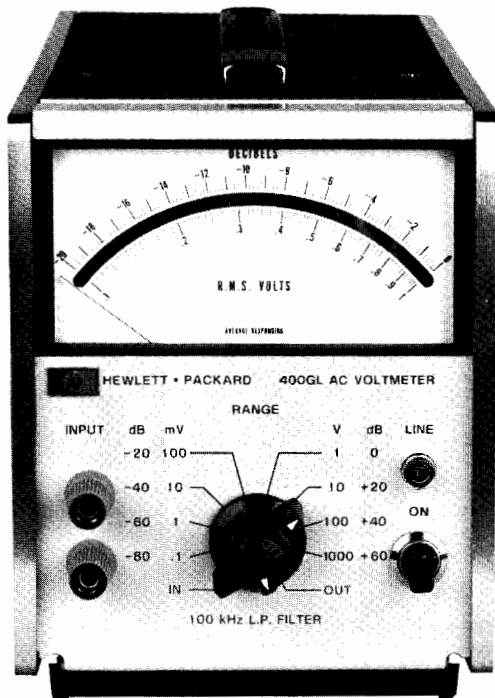

400GL

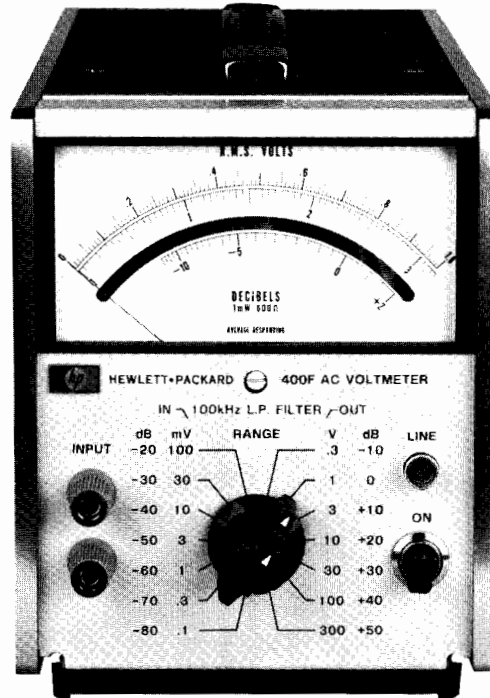

400F

Specifications

	400E/EL*	400F/FL*	400 GL
Voltage range	1 mV to 300 V F.S. 12 ranges	100 μ V to 300 V F.S. 14 ranges	-80 dB to +60 dB F. S. 8 ranges
Frequency range	10 Hz-10 MHz	20 Hz-4MHz	20 Hz-4 MHz
Input impedance	10 M Ω on all ranges <25 pF to <12 pF depending on ranges	10 M Ω on all ranges <30 pF to <15 pF depending on ranges	10 M Ω on all ranges <30 pF to <15 pF depending on ranges
Accuracy*	<p>\pm (% reading + % range)</p> <p>3 mV-300 V ranges</p> <p>10 Hz-40 Hz: $\pm(2.5 + 2.5)$</p> <p>40 Hz-2 MHz: $\pm(1 + 0)$</p> <p>2 MHz-4 MHz: $\pm(1.5 + 1.5)$</p> <p>4 MHz-10 MHz</p> <p>3 mV range: $\pm(2.5 + 2.5)$</p> <p>10 mV-3V range: $\pm(3.0 + 2.0)$ for 4 MHz to 6 MHz</p> <p>$\pm(3.75 + 3.75)$ for 6 MHz to 10 MHz</p> <p>10 V-30 V: $\pm(3.5 + 3.5)$</p> <p>1 mV range</p> <p>10 Hz-40 Hz: $\pm(2.5 + 2.5)$</p> <p>40 Hz-500 kHz: $\pm(1 + 0)$</p> <p>500 kHz-4 MHz: $\pm(2.5 + 2.5)$</p>	<p>(% reading + % range) (% reading)</p> <p>300 μV-300 V ranges</p> <p>F FL</p> <p>20 Hz-40 Hz: $\pm(2 + 2)$ ± 4</p> <p>40 Hz-100 Hz: $\pm(1 + 1)$ ± 2</p> <p>100 Hz-1 MHz: $\pm(\frac{1}{2} + \frac{1}{2})$ ± 1</p> <p>1 MHz-2 MHz: $\pm(1 + 1)$ ± 2</p> <p>2 MHz-4 MHz: $\pm(2 + 2)$ ± 4</p> <p>100 μV range</p> <p>30 Hz-60 Hz: $\pm(2 + 2)$ ± 4</p> <p>60 Hz-100 kHz: $\pm(1 + 1)$ ± 2</p> <p>100 kHz-500 kHz: $\pm(1 + (+0, -7))$ $+1, -8$</p>	<p>+60 dB range</p> <p>20 Hz-40 kHz: ± 0.4 dB</p> <p>40 kHz-100 kHz: ± 0.2 dB</p> <p>-60 dB thru +40 dB ranges</p> <p>20 Hz-40 Hz: ± 0.4 dB</p> <p>40 Hz-500 kHz: ± 0.2 dB</p> <p>500 kHz-2 MHz: ± 0.4 dB</p> <p>2 MHz-4 MHz: $+0.2, -0.8$ dB</p> <p>-80 dB range</p> <p>30 Hz-60 Hz: ± 0.4 dB</p> <p>60 Hz-100 kHz: ± 0.2 dB</p> <p>100 kHz-500 kHz: $+0.2, -0.8$ dB</p>
Recovery	<2 s for 80 dB overload		
Overload	**500 V rms ac, 300 V dc		**1200 V rms max. input; 1000 V dc max. input
Calibration	Responds to average value of input; calibrated in rms value of sine wave. Scale -10 to +2 dB between ranges, 100 divisions on 0 to 1 scale. The dB scale reads -10 to +2 dB; 10 dB between ranges.		Responds to average value of input; calibrated in rms value of sine wave. Linear -20 to 0 dB scale. 100 divisions. 20 dB per range. Log voltage scale.
Weight	Net, 2.7 kg (6 lb). Shipping, 4.1 kg (9 lb)		
Size	159 mm H (without removable feet) x 130 mm W x 297 mm D (6.25" x 5.13" x 11")		
Power	AC: 115 or 230 V $\pm 10\%$, 48 to 440 Hz, 6 VA max. DC: External batteries: + and - voltages between 35 V and 55 V		

* NOTE: 400 EL same as 400E, and 400FL same as 400F, except for calibration. Linear dB scale -10 dB to +2 dB, 10 dB between ranges. Log voltage scales 0.3 to 1 and 0.8 to 3, 120 divisions from -10 dB +2 dB. 400 FL accuracy is % of reading in dB only.

** AC overload voltage decreases with increasing frequency.

ANALOG VOLTMETERS

General Purpose Multi-Function Voltmeter

Model 410C

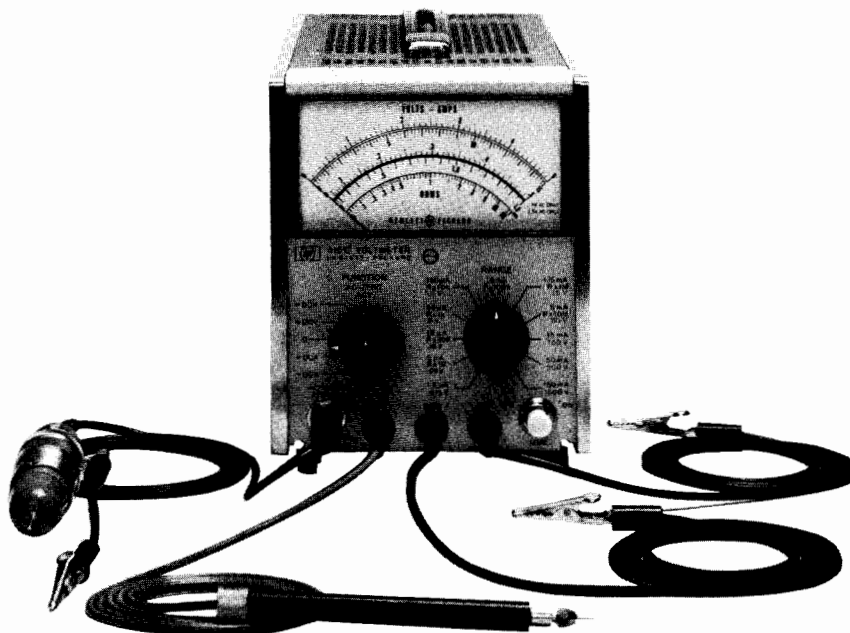

410C with 11036A

Description

HP's Model 410C is a versatile general purpose instrument for use anywhere electrical measurements are made. This instrument measures dc voltages from 15 mV to 1500 V, dc current from 1.5 μ A to 150 mA, and resistance from 0.2 Ω to 500 M Ω . With a standard plug-in probe, ac voltages at 20 Hz to 700 MHz from 50 mV to 300 V and comparative indications to 3 GHz are attainable.

Specifications

DC Voltmeter

Voltage ranges: ± 15 mV to ± 1500 V full scale in 15, 50 sequence (11 ranges).

Accuracy: $\pm 2\%$ of full scale on any range.

Input resistance: 100 M Ω $\pm 1\%$ on 500 mV range and above, 10 M Ω $\pm 3\%$ on 150 mV range and below.

AC Voltmeter

Voltage ranges: 0.5 V to 300 V full scale in 0.5, 1.5, 5 sequence (7 ranges)

Frequency range: 20 Hz to 700 MHz.

Accuracy: $\pm 3\%$ of full scale at 400 Hz for sinusoidal voltages from 0.5 V–300 V rms. The ac probe responds to the positive peak-above-average value of the applied signal. The meter is calibrated in rms.

Frequency response: $\pm 2\%$ from 100 Hz to 50 MHz (400 Hz ref.); 0 to -4% from 50 MHz to 100 MHz; $\pm 10\%$ from 20 Hz to 100 Hz and from 100 MHz to 700 MHz.

Input impedance: input capacitance 1.5 pF, input resistance > 10 M Ω at low frequencies. At high frequencies, impedance drops off due to dielectric loss.

Safety: the probe body is grounded to chassis at all times for safety. All ac measurements are referenced to chassis ground.

DC Ammeter

Current ranges: ± 1.5 μ A to ± 150 mA full scale in 1.5, 5 sequence (11 ranges).

Accuracy: $\pm 3\%$ of full scale on any range.

Input resistance: decreasing from 9 k Ω on 1.5 μ A range to approximately 0.3 Ω on the 150 mA range.

Special current ranges: ± 1.5 , ± 5 and ± 15 μ A may be measured on the 15, 50 and 150 mV ranges using the dc voltmeter probe, with $\pm 5\%$ accuracy and 10 M Ω input resistance.

Ohmmeter

Resistance range: resistance from 10 Ω to 10 M Ω center scale (7 ranges).

Accuracy: zero to midscale: $\pm 5\%$ of reading or $\pm 2\%$ of midscale, whichever is greater; $\pm 7\%$ from midscale to scale value of 2; $\pm 8\%$ from scale value of 2 to 3; $\pm 9\%$ from scale value of 3 to 5; $\pm 10\%$ from scale value of 5 to 10.

Amplifier

Voltage gain: 100 maximum.

AC rejection: 3 dB at 0.5 Hz; approximately 66 dB at 50 Hz and higher frequencies for signals < 1600 V p or 30 times full scale, whichever is smaller.

Isolation: impedance between common and chassis is > 10 M Ω in parallel with 0.1 μ F. Common may be floated up to 400 V dc above chassis for dc and resistance measurements.

Output: proportional to meter indications; 1.5 V dc at full scale, maximum current, 1 mA.

Output impedance: < 3 Ω at dc.

Noise: $< 0.5\%$ of full scale on any range (p-p).

DC drift: $< 0.5\%$ of full scale/yr at constant temperature. $< 0.02\%$ of full scale/ $^{\circ}$ C.

Overload recovery: recovers from 100:1 overload in < 3 s.

General

Maximum input: (see overload recovery). dc: 100 V on 15, 50 and 150 mV ranges, 500 V on 0.5 to 15 V ranges, 1600 V on higher ranges. ac: 100 times full scale or 450 V p whichever is less.

Power: 115 V or 230 V $\pm 10\%$, 50 Hz to 440 Hz, 15 VA (24 VA with 11036A ac probe).

Size: 165 mm H (without removable feet), x 130.2 mm W x 280 mm D (6 $\frac{1}{2}$ " x 5 $\frac{1}{8}$ " x 11") behind panel.

Weight: net, 3.6 kg (8 lb). Shipping, 6.35 kg (14 lb).

Accessories furnished: detachable power cord, 11036A AC probe.

Ordering Information

410C with HP 11036A Detachable ac probe

410C Option 002 (less ac probe)

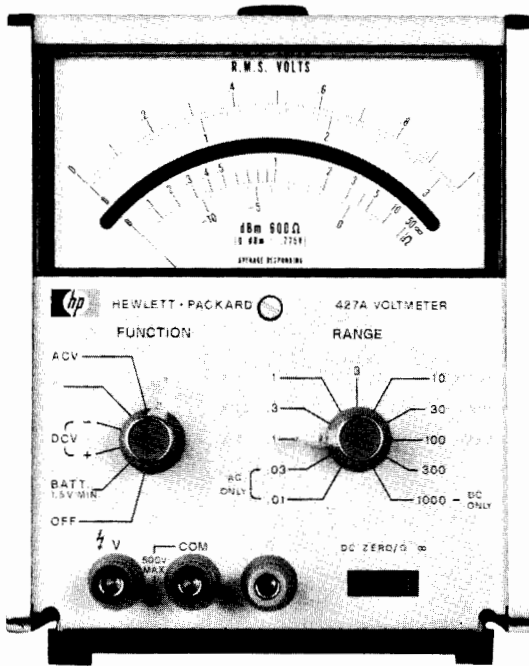

427A

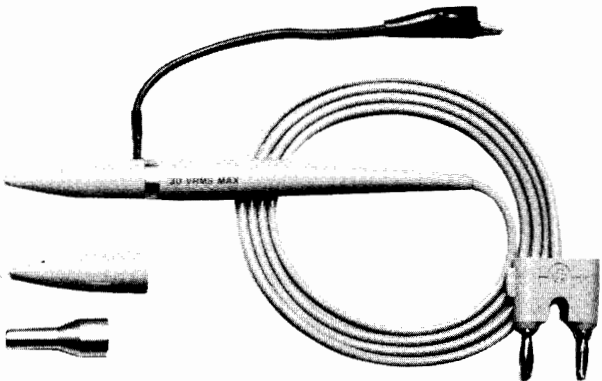

11096B

Description

Hewlett-Packard's Model 427A is a portable, versatile, low cost multi-function meter which is valuable in any laboratory, production line, service department, or in the field. It is capable of measuring dc voltages from 100 mV to 1 kV full scale; ac voltage from 10 mV to 300 V full scale at frequencies up to 1 MHz (>500 MHz with the 11096B High Frequency Probe); and resistance from 10 Ω to 10 MΩ center scale.

The 427A will operate continuously for more than 300 hours on its internal 22.5 V dry cell battery. AC line and battery operation is available with option 001.

Specifications

DC Voltmeter

Ranges: ±100 mV to ±1000 V in 9 ranges in 10 dB steps.

Accuracy: ±2% of range.

Input resistance: 10 MΩ.

AC normal mode rejection (ACNMR): ACNMR is the ratio of the normal mode signal to the resultant error in readout. 50 Hz and above: >80 dB.

Overload protection: 1200 V dc.

AC Voltmeter

Ranges: 10 mV to 300 V in 10 ranges in 10 dB steps.

Frequency range: 10 Hz to 1 MHz.

Response: responds to average value, calibrated in rms.

Accuracy

Frequency	Range	
		0.01 V to 30 V
10 Hz to 100 kHz	2% of range	
100 kHz to 1 MHz	2% of range	

Input impedance: 10 mV to 1 V range, 10 MΩ shunted by <40 pF; 3 V to 300 V range, 10 MΩ shunted by <20 pF.

Overload protection: 300 V rms momentarily, 1 V range and below; 425 V rms max above 1 V range.

Ohmmeter

Ranges: 10 Ω to 10 MΩ center scale in 7 decade ranges.

Accuracy: ± 5% of reading (from 0.3 to 3 on scale)

Source Current (ohms terminal positive)

Range	Open circuit Voltage	Short circuit Current
X 10	0.1 V	10 mA
X 100	0.1 V	1 mA
X 1 k	1 V	1 mA
X 10 k	1 V	100 μA
X 100 K	1 V	10 μA
X 1 M	1 V	1 μA
X 10 M	1 V	0.1 μA

General

Input: may be floated up to ± 500 V dc above chassis ground. Ohms input open in any function except ohms. Volts input open when instrument is off.

Operating temperature: 0°C to 50°C.

Power: >300 hr operation per battery.

HP 427A. 22.5 V dry cell battery, Eveready No. 763 or RCA VS102.

HP 427A Option 001: battery operation or ac line operation, selectable on rear panel. 115 V or 230 V ± 20%, 48 Hz to 400 Hz, 0.7 VA max.

Size: (standard 1/2 module): 159 mm H (without removable feet) x 130 mm W x 203 mm D (6.25" x 5.13" x 8").

Weight: net, 2.4 kg (5.3 lb). Shipping, 3.2 kg (7 lb).

Accessories Available

HP 11096B High Frequency ac Probe extends range to >500 MHz. With the 11096B, you can measure 0.25 to 30 V rms signals out to 500 MHz with better than ±1.2 dB accuracy. Usable relative measurements can be made up to 1 GHz (3 dB point at 700 MHz). The 11096B is a peak-responding detector calibrated to produce a dc output proportional to the rms value of a sine wave input. Input impedance is 4 MΩ shunted by 2 pF.

Options and Accessories

11075A High Impact Case. A rugged case for carrying, storing and operating the 427A

11096B High Frequency AC probe

11002A 60" test lead, dual banana plug to alligator clips

11003A 60" test lead, dual banana plug to pencil probe and alligator clip.

10111A BNC female to dual banana adapter

Ordering Information

427A Multi-function Meter (includes batteries)

427A Option 001 ac power supply & battery

ANALOG VOLTMETERS

1 mA to 10 A Clip-On dc Milliammeter

Model 428B



- No circuit interruption
- No circuit loading



428B



3529A

Description

Direct current from 1 milliamperes to 10 amperes full scale can be measured without interrupting your measured circuit or producing loading errors. With the HP Model 428B Clip-on Milliammeter, cutting wires for insertion of current meters and calculating current from voltage and resistance readings are eliminated. All that is required for fast, accurate readings is to clip around the wire and select the proper current range.

The 428B measures current by utilizing a clip-on transducer that converts the magnetic field around the conductor to an ac voltage proportional to dc current. This voltage is detected and displayed as direct current on the 428B's meter. Since there is no direct contact with the circuit being measured, complete dc isolation is assured.

The meter responds to dc current only and is therefore not susceptible to common mode currents. However, low frequency currents up to 400 Hz can be measured by connecting an oscilloscope or voltmeter to the convenient front panel output; or this output can be used to drive a strip chart recorder for permanent long term records.

For even greater sensitivity, several loops of the measured conductor can be put through the probe, increasing sensitivity by the same factor as the number of turns used.

Specifications

DC current range: 1 mA to 10 A full scale, nine ranges.

Accuracy: $\pm 3\%$ of full scale ± 0.15 mA, from 0°C to 55°C (when instrument is calibrated to probe).

Probe inductance: $< 0.5 \mu\text{H}$.

Probe inducted voltage: < 15 mV p (worst case at 20 kHz and harmonics).

Output: variable linear output level with switch position for calibrated 1 V into open circuit (corresponds to full scale deflection). 1.5 V

max. into open circuit in uncalibrated position. $0.73 \pm .01$ V into 1 k Ω in calibrated position.

Noise: 1 mA range, < 15 mV rms across 1 k Ω ; 3 mA range, < 5 mV rms across 1 k Ω ; 10 mA through 10 A ranges, < 2 mV rms across 1 k Ω .

Frequency range: dc to 400 Hz (3 dB point).

AC rejection: signals > 5 Hz with pk value $<$ full scale affect meter accuracy $< 2\%$ (except at 40 kHz carrier frequency and its harmonics). On the 10 A range, ac pk value is limited to 4 A.

Power: 115 or 230 V $\pm 10\%$, 50 to 60 Hz, approx. 75 V A max.

Operating temperature range: -20°C to $+55^\circ\text{C}$.

Probe insulation: 300 V maximum.

Probe tip size: ≈ 0.5 in. (12.7 mm) by 0.66 " (16.67 mm) aperture diameter 0.16 in. (3.97 mm).

Size: cabinet: 292 H x 191 W x 368 mm D (11.5" x 7.5" x 14.5").

Weight: net, 8.6 kg (19 lb). Shipping, 10.9 kg (24 lb).

Accessories Available

3529A Magnetometer Probe: this probe measures magnetic field strength and direction. The component of magnetic field sensed is parallel to the cylindrical axis of the probe. Applications include the testing of magnetic materials for air shipment.

Range: 1 mG to 10 G full scale, nine ranges.

1 mG = 1 mA conversion factor.

Accuracy: $\pm 3\%$ of full scale (0°C to $+55^\circ\text{C}$) after calibration.

Frequency range: dc to 80 Hz (3 dB point).

Weight: net 0.45 kg (1 lb). Shipping 0.91 kg (2 lb).

Ordering Information

3529A Magnetometer Probe

428B Analog Milliammeter

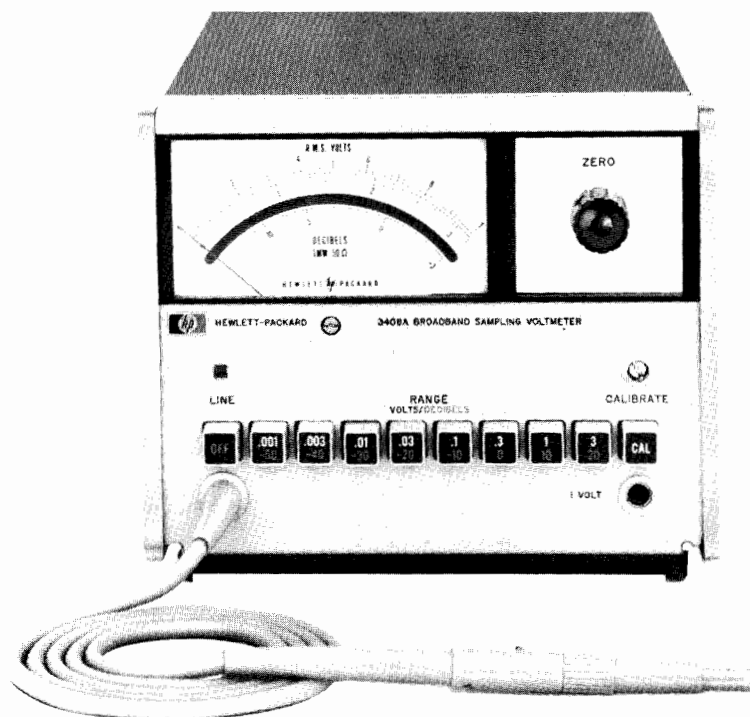

Description

High frequency voltages can be measured easily with HP's 3406A Sampling Voltmeter. Employing sampling techniques, the HP 3406A has extremely wide bandwidth (10kHz to 1.2 GHz) with high input impedance. Signals as small as 50 μ V can be resolved. Full scale sensitivity from 1 mV to 3 V is selected in eight 10 dB steps and may be read directly from -62 dBm to +23 dBm. Accessory probe tips convert the HP 3406A for voltage measurements in applications such as receivers, amplifiers and coaxial transmission lines.

Measurement can be retained on the 3406A meter by depressing a pushbutton located on the pen-type probe. This is useful when measurements are made in awkward positions where the operator cannot observe the meter indication and probe placement at the same time.

Specifications

Voltage range: 1 mV to 3 V full scale in 8 ranges; decibels from -50 to +20 dBm (0 dBm = 1 mW into 50 Ω); average-responding instrument calibrated to rms value of sine wave.

Frequency range: 10 kHz to 1.2 GHz; useful sensitivity from 1 kHz to beyond 2 GHz.

Full-Scale Accuracy (%) with Appropriate Accessory (after probe is properly calibrated)

10 kHz	20 kHz	25 kHz	100 kHz	100 MHz	700 MHz	1 GHz	1.2 GHz
± 13	± 8	± 5	± 3	± 5	± 8	± 8	± 13

Input impedance: input capacity and resistance will depend upon accessory tip used. 100,000 Ω shunted by <2.1 pF at 100 kHz with bare probe; <10 pF with 11072A isolator tip supplied.

Sample Hold Output

Provides ac signal whose unclamped portion has statistics that are narrowly distributed about the statistics of the input, inverted in sign

(operating into >200 k Ω load with <1000 pF). Output is 0.316 V at f.s. on any range.

Noise: <175 μ V rms referred to input.

Accuracy (after calibration): 0.01 V range and above: same as full scale accuracy of instrument. 0.001 V to 0.003 V range: value of input signal can be computed by taking into account the residual noise of the instrument. Jitter: meter indicates within $\pm 2\%$ pk of reading 95% of time (as measured with HP 3400A True RMS Voltmeter).

RMS crest factor: 0.001 V to 0.3 V, 20 dB; 1 V, 13 dB; 3 V, 3 dB.

Meter

Meter scales: linear voltage, 0 to 1 and 0 to 3; decibel, -12 to +3. Individually calibrated taut-band meter.

Response time: indicates within specified accuracy in <3 s.

Jitter: $\pm 1\%$ peak (of reading).

General

DC recorder output: adjustable from 0 to 1.2 mA into 1000 ohms at full scale, proportional to meter deflection.

Overload recovery time: meter indicates within specified accuracy in <5 μ s (30 V p-p max.).

Maximum input: ± 100 V dc, 30 V p-p.

RFI: conducted and radiated leakage limits are below those specified in MIL-6181D and MIL-1-16910C except for pulses emitted from probe. Spectral intensity of these pulses is nominally 50 nV/ $\sqrt{\text{Hz}}$; spectrum, extends beyond 2 GHz.

Temperature range: instrument, 0 $^{\circ}$ C to +55 $^{\circ}$ C; probe, +10 $^{\circ}$ C to +40 $^{\circ}$ C.

Power: 115 or 230 V $\pm 10\%$, 48 Hz to 66 Hz, 25 VA max.

Size: 159 mm H (without removable feet), x 197 mm W x 279 mm D (6.25" x 7.75" x 11"); $\frac{1}{2}$ module.

Weight: net, 5.4 kg (12 lb). Shipping, 6.8 kg (15 lb).

Accessories: refer to data sheet.

3406A RF Voltmeter



DVM's have historically been optimized for either a systems environment where speed is important or for bench applications where high accuracy, high resolution and low noise are paramount. HP offers both systems and bench dmm's with speed and accuracy trade-offs provided by the multislope A/D technique introduced in the HP 3456A. The HP 3456A is the high accuracy, high speed dmm equipped with HP-IB for test system applications. The HP 3468A/B and 3478A are a family of lower cost dmm's with 3½ to 5½ digit resolution and a full five functions. The HP 3478A is completely programmable via HP-IB and the HP 3468A/B are completely programmable via HP-IL. The HP 3468A dmm comes in a streamlined case with handle suited to portable applications and the new HP 3468B is in a rack and stack case for convenient bench use.

The new family of lower cost dmm's have a new electronic calibration that eliminates potentiometer adjustments. Calibration constants are stored in non-volatile memory and kept alive by a lithium battery capable of retaining the calibration constants for more than 10 years.

A new, low cost interface for peripheral and instrumentation is found in the HP 3468A/B. It is called HP-IL, the Hewlett-Packard Interface Loop. The new interface

offers a low power, multidrop serial interface which allows interfacing between handheld calculators like the HP 41C/CV and the series 80 Personal Computers and the HP 3468A/B DMMs. All of this computational power can be applied to automate measurements on the bench or in a production environment.

With the power of a programmable calculator and the HP 3468A/B, software can easily be developed to analyze and store data for a customer's specific application. For example, if a customer needs to measure temperature, he can use the HP 41C/CV to linearize the transducer device and display the results in degrees C or F right on the display of the HP 3468A/B. With a simple HP 41C/CV program, the HP 3468A/B can display in dBm referenced to any impedance for audio and telecommunication applications. For applications such as resistor tolerance or performance testing of a device, the HP 3468A/B can easily be programmed to provide the measurements necessary for tolerance testing.

For HP-IB systems the new HP 3478A DMM offers high system performance at low cost bench prices. The HP 3478A measures dc volts, true rms ac volts, 2 and 4 wire ohms, and current with 3½, 4½, or 5½ digit resolu-

tion. It measures dc voltage from 30 mV full scale with 100 nanovolt sensitivity up to 300 volts. This wide dynamic range allows detection of low level signals or higher voltages and reduces the amount of signal conditioning necessary. The HP 3478A has a 300 kHz bandwidth and 4:1 crest factor to give customers confidence in true rms ac voltage measurements. Either 2-wire or 4-wire ohms measurements can be selected with a maximum range of 30 Mohms down to a 100 microhm sensitivity on the 30 ohm range. 4-wire ohms can be used for reducing errors caused by cable resistance and relay scanners in a customer's system or the 2-wire ohms can be used for convenience. Both .3 A and 3 A ranges of dc and true rms ac current are provided, completing the function capability of the HP 3478A.

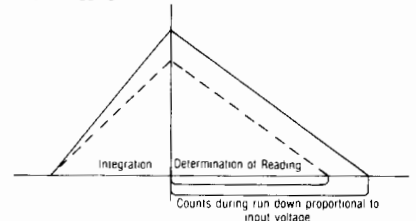

Figure 1. The classical dual-slope integration technique is limited in speed to how fast the zero crossing can be detected accurately. In addition, the final reading is not known until rundown has been completed. Note that the voltage remaining on the integrator's capacitor is proportional to input level.



HP IC Technology Lowers the Cost of Multi-slope A/D Conversion

The A/D conversion technique pioneered by the HP 3456A has been refined with monolithic clip technology on the HP 3468A/B and 3478A to give high performance at very low cost. In addition, the re-

duced number of parts in the new multi-meters means reduced service problems and lower cost of ownership. The basic design contributions of the multi-slope technique are:

1. Speed
2. Elimination of high speed logic in the zero comparator.
3. Keeping the run-up slopes steep to effectively extend the range of the comparator.
4. Completion of the A/D conversion during the measurement.
5. Conversion of the gain errors and timing errors into offset errors where they can be subtracted out.

In summary, the design emphasis of the HP 3468A/B and 3478A lets the customer match his DMM needs to the performance level required. Either extremely high performance in resolution, speed, and accuracy with the HP 3456A or low cost for

automated bench use with the HP 3468A/B & 3478A. The DMM Selection Chart below can help in the selection of the DVM for a bench or system application.

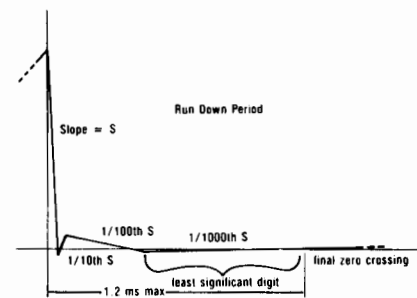

Figure 2. The Multi-slope II technique used in the 3456A Digital Voltmeter employs a four-slope rundown to successively establish the value of the four least significant digits in the final reading. Note that the final zero crossing which determines the least significant digits is done with the shallowest slope.

BENCH DVM'S

DVM's	Features	dc Volts					ac Volts		Resistance			Current		General		
		Max. Input	Rdgs/Sec	Ranges	Sensitivity	Basic Accuracy	Bandwidth	Ranges	Sensitivity	Open Circuit Voltage	ac	dc	Ranging	Over-range	Other	
3435A 3½ digit p. 86	<ul style="list-style-type: none"> Accuracy 10 milli Ω 	1200 V	4.7	100 mV to 1200 V	100 μV	± (.1% Rdg. + 1 count)	100 kHz	10 Ω to 10 MΩ	10 milli Ω	< 5 V	Yes	Yes	Auto/Manual	100%	Battery Power Opt 002	
3466A 4½ digit p. 87	<ul style="list-style-type: none"> Autorange True RMS 1 μV sensitivity 	1200V	4.7	10 mV to 1200 V	1 μV	± (.03% Rdg. + 1 count)	100 kHz True rms	10 Ω to 10 MΩ	1 milli Ω	< 5 V	Yes True rms	Yes	Auto/Manual	100%	Battery Power Trms/ac or dc	
3468A/B 3½-5½ digit p. 84	<ul style="list-style-type: none"> HP-IL 5 Functions Low Cost 	300 V	32 (3.7 with 5½ digit)	.3 V to 300 V	1 μV	± (.0035% Rdg. + 2 counts)	300 kHz True rms	300 Ω to 30 MΩ	1 mΩ	< 6.5 V	Yes True rms	Yes	Auto/Manual	N/A	Battery-Option 001 HP-IL	

SYSTEM DVM'S

DVM's	Features	dc Volts					ac Volts		Resistance			Current		General		
		Max. Input	Rdgs/Sec	Ranges	Sensitivity	Basic Accuracy	Bandwidth	Ranges	Sensitivity	Open Circuit Voltage	ac	dc	Ranging	Over-range	Other	
3437A 3½ digit p. 93	<ul style="list-style-type: none"> HP-IB High speed Sample/Hold 	20 V	5700	100 mV to 10 V	100 μV	± (.03% Rdg. + 2 counts)							Manual	100%	HP-IB Int. timer Sample/Hold Hold	
3455A 5½, 6½ digit p. 94	<ul style="list-style-type: none"> HP-IB AutoCal 	1000 V	24	100 mV to 1000 V	1 μV	± (.002% Rdg. + 1 count)	1 MHz True rms	100 Ω to 10 MΩ	1 milli Ω	< 5 V			Auto/Manual	50%	HP-IB, guarded, 4 terminals, Math	
3456A 3½, 4½, 5½, 6½ digit p. 90	<ul style="list-style-type: none"> High Performance Selective integration time 	1000 V	330 (48 with 6½ digits)	100 mV to 1000 V	100 nV	± (.0008% Rdg. + 2 counts)	250 kHz True rms	100 Ω to 1 GΩ	100 μΩ	< 9.5 V			Auto/Manual	20%	HP-IB, guarded, Statistics, Pass/Fail, Offset, % error	
3478A 3½-5½ digit p. 88	<ul style="list-style-type: none"> HP-IB 5 Function Low Cost 	300 V	71 (4.4 with 5½ digits)	30 mV to 300 V	100 nV	± (.0034% Rdg. + 2 counts)	300 kHz True rms	30 Ω to 30 MΩ	100 μΩ	< 6.5 V	Yes True rms	Yes	Auto/Manual	N/A	HP-IB, 4 Wire Ω, Full 5 Functions	
3497A 3½, 4½, 5½ digit p. 52	<ul style="list-style-type: none"> Selectable # of digits Built-in memory 	120 V	300 (50 with 5½ digits)	0.1 V to 100 V	1 μV	± (.002% Rdg. + 1 count)		Program. current source for ohms					Auto/Manual	20%	HP-IB, Guarded Built-in mem. Program. current source	

DIGITAL VOLTMETERS

5½ to 3½ Digit, HP-IL

Model 3468A/B

- Five functions
- HP-IL programmable

- Electronic calibration
- 5½ to 3½ digits

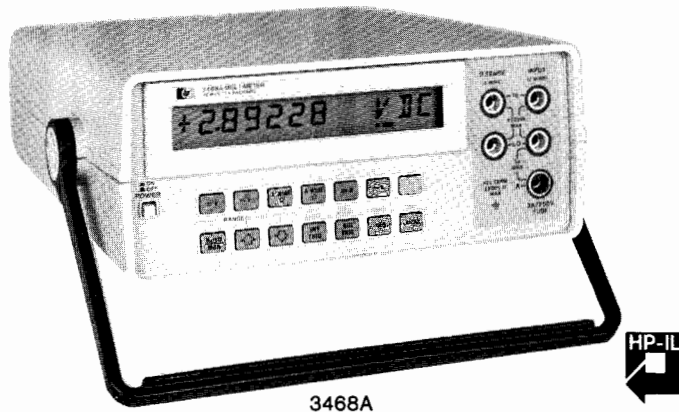

3468A

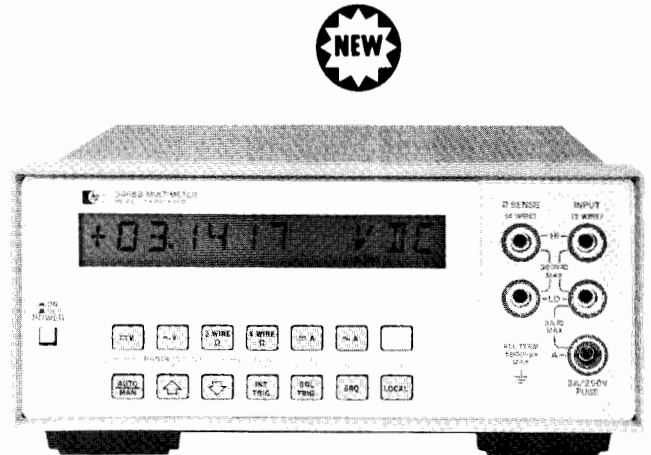

3468B

Description

The 3468A/B are autoranging 5½ to 3½ digit DMM's, with the five functions of dc volts, true RMS ac volts, 2 and 4-wire ohms, dc current and true RMS ac current. The 3468A comes in a streamlined portable package with a handle and the 3468B comes in a plastic system case for easy rack mounting. Both interface with HP-IL (Hewlett-Packard Interface Loop) providing complete programmability of functions, ranges and modifiers. The 3468A/B can also be completely calibrated electronically without any adjustments either from the front panel or remotely in an automatic calibration system. Both are available with a rechargeable battery and battery charging circuitry for portable measurements.

HP-IL

The 3468A/B are fully programmable with HP-IL, a new two-wire serial interface, and the HP 41C/CV handheld calculators or the more powerful HP series 80 computers. HP-IL provides automatic measurements and adds computational power to a bench DMM. For example, to measure temperature, the HP 41 can linearize a transducer device and display the results in degrees C or degrees F right on the display of the 3468A/B. For audio and telecommunication applications, the 3468A/B can measure ac voltage and the HP 41 can convert to dBm referenced to any impedance. Or the HP 41 can be programmed to get data from the 3468A/B and perform a % error calculation, then display the results in percent on the 3468A/B display.

High Performance

The 3468A/B have 5 functions with selectable 5½, 4½ or 3½ digit resolution. DC and true RMS ac voltage measurements are provided from 0.3 volt full scale range with 1 μV sensitivity up to 300 volts. The bandwidth of the true RMS ac converter is from 20 Hz to 100 kHz on all ranges and up to 300 kHz on the 30 V range. Either 2 or 4-wire ohms measurements can be selected with a maximum range of 30 MΩ. Both dc and true RMS ac current capability is provided up to 3 A. All functions on the 3468A/B incorporate a fast autoranging. The 3468A/B use an integrating analog to digital conversion technique for high noise rejection. The selectable 3½, 4½ or 5½ digits of resolution allows flexibility for choosing speed or noise rejection.

Electronic Calibration

Complete calibration of the 3468A/B is done electronically, either manually from the front panel or remotely in an automatic calibration system. There are no internal adjustments. Complete calibration of all functions is done without removal of the instrument's covers, thus saving valuable time and reducing cost. The calibration procedure for the 3468A/B involves connecting a calibration standard to the input, then pressing three keystrokes to store one calibration constant in CMOS RAM for each range and function. When the 3468A/B make a measurement, each reading is corrected according to the calibration constants that have been stored. The internal CMOS RAM used in the 3468A/B is powered by a lithium battery to create a non-volatile memory capable of holding the calibration constants for more than ten years.

Battery

The optional battery pack includes a rechargeable battery and the battery charger circuitry for up to five hours of continuous measurements.

DC Voltage

Input Characteristics

Range	Maximum Reading (5½ digit)	Resolution		
		5½ digit	4½ digit	3½ digit
.3 V	± .301000 V	1 μV	10 μV	100 μV
3 V	± 3.01000 V	10 μV	100 μV	1 mV
30 V	± 30.1000 V	100 μV	1 mV	10 mV
300 V	± 301.000 V	1 mV	10 mV	100 mV

Input resistance: .3 V, 3 V ranges: > 10¹⁰ Ω
30 V, 300 V ranges: 10 MΩ ± 1%

Maximum Input Voltage (non-destructive)

Hi to Lo: 301 Vrms or 450 V peak

Hi or Lo to Earth Ground: ± 500 V peak

Measurement accuracy: ± (% of reading + number of counts). Auto zero ON. 5½ digits.

Range	T _{Cal} * ± 1°C 24 Hour	T _{Cal} * ± 5°C	
		90 Day	1 Year
.3 V	0.005 + 4	0.009 + 5	0.02 + 5
3 V	0.0035 + 2	0.007 + 2	0.018 + 2
30 V	0.005 + 3	0.009 + 3	0.02 + 3
300 V	0.0055 + 2	0.009 + 2	0.02 + 2

*T_{Cal} is the temperature of the environment where the 3468A/B was calibrated. Calibration should be performed with the temperature of the environment between 20°C and 30°C.



Temperature coefficient: 0°C to 55°C, 5½ digits, auto zero ON.
± (% of reading + number of counts)/°C.

Range	Temperature Coefficient
.3 V, 30 V	0.0008 + .5
3 V, 300 V	0.0007 + .05

Noise rejection: in dB, with 1 kΩ imbalance in Lo lead. AC rejection for 50, 60 Hz ± 0.1%. Auto zero ON.

Display	AC NMR	AC ECMR	DC CMR
5½ digits	80	150	140
4½ digits	59	130	140
3½ digits	0	70	140

Maximum reading rate with HP 85: 32 readings/sec

Maximum reading rate with 41 CV: 2 readings/sec

Resistance (2-wire Ω, 4-wire Ω)

Input Characteristics

Range	Maximum Reading (5½ digit)	Resolution		
		5½ digit	4½ digit	3½ digit
300 Ω	301.000 Ω	1 mΩ	10 mΩ	100 mΩ
3 kΩ	3.01000 kΩ	10 mΩ	100 mΩ	1 Ω
30 kΩ	30.1000 kΩ	100 mΩ	1 Ω	10 Ω
300 kΩ	301.000 kΩ	1 Ω	10 Ω	100 Ω
3 MΩ	3.01000 MΩ	10 Ω	100 Ω	1 kΩ
30 MΩ	30.1000 MΩ	100 Ω	1 kΩ	10 kΩ

Input protection: (non-destructive): ± 350 V peak

Measurement accuracy: ± (% of reading + number of counts). Auto zero ON. 5½ digit display. 4-wire ohms.

Range	TCal* ± 1°C 24 Hour	TCal* ± 5°C	
		90 Day	1 Year
300 Ω	0.004 + 4	0.012 + 4	0.017 + 5
3 kΩ-300 kΩ	0.004 + 2	0.011 + 2	0.016 + 2
3 MΩ	0.005 + 2	0.011 + 2	0.016 + 2
30 MΩ	0.036 + 2	0.066 + 2	0.078 + 2

Current Through Unknown

Range	300 Ω	3 kΩ	30 kΩ	300 kΩ	3 MΩ	30 MΩ
Current	1 mA	1 mA	100 μA	10 μA	1 μA	100 nA

Maximum open circuit voltage: 6.5 V

AC Voltage (true RMS responding)

Input Characteristics

Range	Maximum Reading (5½ digit)	Resolution		
		5½ digit	4½ digit	3½ digit
.3 V	.301000 V	1 μV	10 μV	100 μV
3 V	3.01000 V	10 μV	100 μV	1 mV
30 V	30.1000 V	100 μV	1 mV	10 mV
300 V	301.000 V	1 mV	10 mV	100 mV

Input impedance: 1 MΩ ± 1% shunted by <60 pF.

Maximum input voltage (non-destructive): 301 Vrms or 450 V peak.

Measurement accuracy: ± (% of reading + number of counts). Auto zero ON. 5½ digit display. Accuracy is specified for sinewave inputs only, > 10% of full scale.

1 Year, TCal ± 5°C

Frequency	Ranges		
	.3V	3 V, 30 V	300 V
20-50 Hz	1.14 + 163	1.14 + 102	1.18 + 102
50-100 Hz	0.46 + 163	0.46 + 103	0.5 + 102
100 Hz-20 kHz	0.29 + 163	0.26 + 102	0.33 + 102
20-50 kHz	0.56 + 247	0.41 + 180	0.55 + 180
50-100 kHz	1.74 + 882	1.05 + 825	1.26 + 825
100 k-300 kHz	10.1 + 3720 (30 V range only)		

Crest factor: >4:1 at full scale.

DC Current

Input Characteristics

Range	Maximum Reading (5½ digit)	Resolution		
		5½ digit	4½ digit	3½ digit
3 A	±3.01000 A	10 μA	100 μA	1 mA

Maximum input (non-destructive): 3 A from <250 V source; fuse protected.

Measurement accuracy: ± (% of reading + number of counts). Auto zero ON. 5½ digit display.

Range	TCal ± 5°C	
	90 Days	1 Year
3 A, <1 A input	0.14 + 6	0.17 + 6
3 A, >1 A input	1.0 + 30	1.0 + 30

AC Current (true RMS responding)

Input Characteristics

Range	Maximum Reading (5½ digit)	Resolution		
		5½ digit	4½ digit	3½ digit
.3 A	.301000 A	1 μA	10 μA	100 μA
3 A	3.01000 A	10 μA	100 μA	1 mA

Maximum input (non-destructive): 3 A from <250 V source; fuse protected.

Measurement accuracy: ± (% of reading + number of counts). Auto zero ON. 5½ digit display. Accuracy specified for sinewave inputs only, > 10% of full scale.

1 Year, TCal ± 5°C

Frequency	Ranges	
	.3 A	3 A
20-50 Hz	1.77 + 163	2.5 + 163
50-1 kHz	1.1 + 163	1.8 + 163
1 k-10 kHz	1.0 + 163	1.7 + 163
10 k-20 kHz	1.14 + 163	1.84 + 163

General Information

Operating temperature: 0 to 55°C

Humidity range: 95% R.H., 0 to 40°C

Power: AC line 48 to 440 Hz, 86 to 250 V, (see configuration)

Battery: (Opt 001) Rechargeable lead-acid; minimum continuous operation for 5 hours at 25°C; recharge time is 16 hours with 3468A/B off and 36 hours with 3468A/B on.

Size: 3468A: 98.4 mm H x 238.1 mm W x 276.2 mm D (3.88 in. H x 9.38 in. W x 10.88 in. D). 3468B: 89 mm H x 213 mm W x 275 mm D (without feet), 3.5 in. H x 8.38 in. W x 10.83 in. D.

Weight: 3468A/B—2.1 kg (4.63 lbs); 3468A/B with Opt 001—3.1 kg (6.83 lbs).

Configuration: order one power and frequency option at no charge from below.

Opt 315: 100 V, 50 Hz; **Opt 335:** 220 V, 50 Hz

Opt 316: 100 V, 60 Hz; **Opt 336:** 220 V, 60 Hz

Opt 325: 120 V, 50 Hz; **Opt 345:** 240 V, 50 Hz

Opt 326: 120 V, 60 Hz; **Opt 346:** 240 V, 60 Hz

Ordering Information

3468A DMM in Streamlined Portable Case with HP-IL and test probes.

3468B DMM in Rack and Stack Case with HP-IL and Test probes.

3468A/B Option 001, add Rechargeable Battery Pack

3468A/B Option 541, add 41CV Handheld Computer and 82160A HP-IL Interface Module

3468A/B Option 561, add 82161A Digital Cassette Drive

3468A/B Option 562, add 82162A Thermal Printer/Plotter



DIGITAL VOLTMETERS

3½ Digit, High Accuracy DMM

Model 3435A

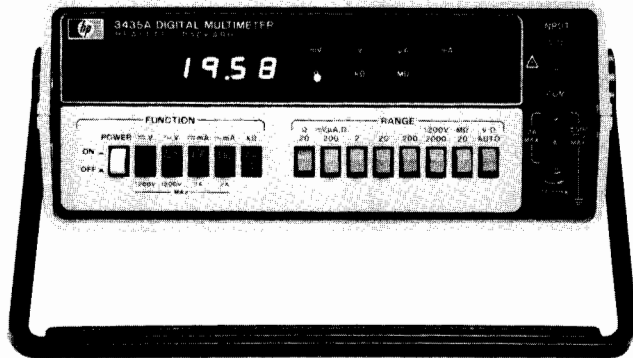

Description

The 3435A is a 3½ digit multimeter providing five functions of ACV, DCV, ACI, DCI and Ω . It is available with rechargeable batteries or ac line power only. The 34112A Touch-Hold probe provides "eyes-on" probing of ac and dc voltages by holding the 3435A display using a button on the probe. The 3435A case is rugged with a detent position carrying handle which is used also as a tilt stand.

Specifications

DC Voltmeter

Ranges:	Maximum display:
200 mV	± 199.9 mV
2 V	± 1.999 V
20 V	± 19.99 V
200 V	± 199.9 V
1200 V	± 1199 V

Maximum input: 1200 V (dc + Peak ac)

Accuracy: 1 year, 15 to 30°C.

Range	Specifications
200 mV	$\pm(0.1\%$ of reading + 2 counts)
2 V to 1200 V	$\pm(0.1\%$ of reading + 1 count)

Temperature coefficient: (0 to 15°C and 30 to 55°C) $\pm(0.015\%$ of reading + 0.1 count)/°C.

Input resistance: 10 M Ω $\pm 1\%$.

Input type: floating, 500 V maximum com. to ground.

Normal mode rejection: >40 dB at 50 Hz/60 Hz $\pm 0.1\%$.

Response time: <0.7 second to within 1 count of final value on one range. Add 1 second for each range change.

Effective common mode rejection: (1 k Ω unbalance) >120 dB at 50/60 Hz $\pm 0.1\%$.

AC Voltmeter

AC converter: avg. responding rms calibrated.

Ranges:	Maximum display:
200 mV	199.9 mV
2 V	1.999 V
20 V	19.99 V
200 V	199.9 V
1200 V	1199 V

Maximum input: 1700 V (dc + Peak ac), 10⁷ volt-Hz max.

Accuracy: (with display of ≥ 20 counts) 1 year, 15 to 30°C.

Range	Specification
30 Hz–50 Hz	$\pm(1.5\%$ of reading + 3 counts)
50 Hz–20 kHz	$\pm(0.3\%$ of reading + 3 counts)
20 kHz–100 kHz	$\pm(1.5\%$ of reading + 10 counts)

Temperature coefficient: (0 to 15°C and 30 to 55°C) $\pm(0.04\%$ of reading + 0.2 count)/°C.

Input impedance: resistance: 5 M Ω . Shunt capacitance: <50 pF.

Ohmmeter

Ranges	Maximum Display	Current Through Unknown
20 Ω	19.99 Ω	5 mA
200 Ω	199.9 Ω	5 mA
2 k Ω	1.999 k Ω	500 μ A
20 k Ω	19.99 k Ω	50 μ A
200 k Ω	199.9 k Ω	5 μ A
2000 k Ω	1999 k Ω	500 nA
20 M Ω	19.99 M Ω	50 nA

Input protection: 250 V rms.

Accuracy: 1 year, 15 to 30°C.

Range	Specifications
20 Ω	$\pm(0.5\%$ of reading + 12 counts)
200 Ω –2000 k Ω	$\pm(0.2\%$ of reading + 2 counts)
20 M Ω	$\pm(0.8\%$ of reading + 2 counts)

Temperature coefficient: (0 to 15°C and 30 to 55°C)

Range	Specifications
20 Ω –2000 k Ω	$\pm(0.04\%$ of reading + 0.2 count)/°C
20 M Ω	$\pm(0.18\%$ of reading + 0.2 count)/°C

DC Current and AC Current

Ranges:	Maximum display:
200 μ A	± 199.9 μ A
2 mA	± 1.999 mA
20 mA	± 19.99 mA
200 mA	± 199.9 mA
2000 mA	± 1999 mA

Maximum input: current: 2 amp (fuse protected). Voltage: 250 V.

DC current accuracy: 1 year, 15 to 30°C.

Range	Specifications
200 μ A to 200 mA	$\pm(0.3\%$ of reading + 2 counts)
2000 mA	$\pm(0.6\%$ of reading + 2 counts)

AC current accuracy: (with display of ≥ 20 counts)—1 year, 15 to 30°C.

Current Range	30 Hz	50 Hz	10 kHz
2000 mA	$\pm(2\%$ of reading + 5 counts)	$\pm(1.2\%$ of reading + 5 counts)	
200 mA To 200 μ A	$\pm(1.7\%$ of reading + 5 counts)	$\pm(0.9\%$ of reading + 5 counts)	

General

Reading rate: 2.4 – 4.7/s depending on input level.

Ranging: automatic or manual on ACV, DCV and ohms. Manual only on ac & dc current.

Operating temperature: 0 to 55°C.

Humidity: 95% RH, +15 to +40°C.

Power: ac line: 48–440 Hz; 86–250 V (see ordering information). Battery: rechargeable lead-acid 10 hours minimum continuous operation with full charge. Recharge time: 16 hours operating, 12 hours nonoperating.

Size: 3435A: 23.91 cm W x 9.84 cm H x 27.62 cm D (9.4" x 3.9" x 10.9").

Weight: 3435A: 2.41 kg (5.3 lb); 3435A Opt 001: 1.84 kg (4.1 lb).

Ordering Information

3435A streamlined portable case with handle, ac line power. Batteries and charger included.

3435A Opt. 001, streamlined portable case, ac line power only.

3435A Opt. 002, Rack and Stack case, ac line power only. (Rack mount kit not included.)

All orders must include one of the power options: 86–106 V Opt. 100; 190–233 V Opt. 210; 104–127 V Opt. 115; 208–250 V Opt. 230.



Description

The 3466A is a 4 1/2 digit Multimeter with autoranging volts and ohms. Functional capability includes ACV, DCV, (ac + dc) V, ACI, DCI, (ac + dc) I, Ω , and diode test. AC measurements are True-RMS with selectable ac or dc coupling. Available with rechargeable batteries or ac power only, it has 1 μ V dc and 1 m Ω sensitivity with zero adjustment on lowest ranges to compensate for external offsets.

Specifications

DC Voltmeter

Voltage Range	Maximum Display
20 mV	± 19.999 mV
200 mV	± 199.99 mV
2 V	± 1.9999 V
20 V	± 19.999 V
200 V	± 199.99 V
1200 V	± 1199.9 V

Maximum Input: ± 1200 V maximum dc and peak ac.

Accuracy: (1 yr., 18 to 28°C)

Range	\pm (% of reading + # of counts)
20 mV	(.05 + 3)
200 mV	(.04 + 2)
2 V — 200 V	(.03 + 1)
1200 V, <700 V input	(.035 + 1)
1200 V, >700 V input	(.055 + 1)

Input resistance: 10 meg Ω $\pm 0.5\%$ all ranges.

Input type: floating, 500 V maximum common to ground.

AC Voltmeter

AC converter: true-RMS Responding True-RMS Calibrated

Range	Maximum Display
200 mV	199.99 mV
2 V	1.9999 V
20 V	19.999 V
200 V	199.99 V
1200 V	1199.9 V

Maximum Input: (ac + dc): ± 1200 V DC; ± 1700 V (dc + Peak ac), ac: ± 600 V dc; 1700 V (Peak ac + dc), 10^7 V \cdot Hz.

Crest factor: 4:1 at Full Scale.

Accuracy (with display of $\geq 10\%$ of range): 1 yr., 18 to 28°C sinusoid waveform.

AC TRMS: (20 Hz to 100 kHz)

Frequency Range	\pm (% of reading + # of counts)
20 Hz to 30 Hz	(2 + 50)
30 Hz to 50 Hz	(1 + 30)
50 Hz to 10 kHz	(0.3 + 20)
10 kHz to 20 kHz	(1 + 40)
20 kHz to 100 kHz	(2 + 150)

DC + AC TRMS: dc + (20 Hz to 100 kHz).

Ohmmeter

Ohms Range	Maximum Display	Current Through Unknown	Accuracy: 1 yr., 18 to 28°C \pm (% of reading + # of counts)
20 Ω	19.999 Ω	5 mA	.08 + 2
200 Ω	199.99 Ω	5 mA	.08 + 2
2 k Ω	1.9999 k Ω	1 mA	.03 + 1
20 k Ω	19.999 k Ω	100 μ A	.03 + 1
200 k Ω	199.99 k Ω	10 μ A	.03 + 1
2000 k Ω	1999.9 k Ω	1 μ A	.04 + 1
20 M Ω	19.999 M Ω	100 nA	.15 + 1

Input protection: 250 V RMS or 350 V (dc + peak ac).

DC Current and True RMS AC Current

Current Range	Maximum Display
200 μ A	± 199.99 μ A
2 mA	± 1.9999 mA
20 mA	± 19.999 mA
200 mA	± 199.99 mA
2000 mA	± 1999.9 mA

Maximum input: 2 amp rms from < 250 V source (fuse protected).

DC Current Accuracy (1 yr., 18 to 28°C):

Range	\pm (% reading + # of counts)
200 μ A through 20 mA	(.07 + 2)
200 mA	(0.15 + 2)
2000 mA	(0.5 + 2)

AC current accuracy: (with display $\geq 10\%$ of range) 1 yr., 18°C to 28°C, sinusoid waveform.

AC TRMS: 20 Hz to 10 kHz.

Range	Frequency	\pm (% of reading + # of counts)
200 μ A–200 mA	20 Hz–30 Hz	2 + 50
	30 Hz–10 kHz	0.9 + 35
2000 mA	20 Hz–30 Hz	2 + 50
	30 Hz–10 kHz	1.2 + 20

(DC + AC) TRMS: dc + (20 Hz to 10 kHz).

Diode Test

Function: $\rightarrow+$ (k Ω). **Range:** $\rightarrow+$ (2k Ω).

Current source: 1 mA $\pm 1.5\%$.

Diode voltage drop displayed in volts: 1.9999 volts maximum.

General

Reading rate: 2.4 to 4.7/sec. depending on input level.

Operating temperature: (0 to 55)°C.

Humidity: 95% RH at +40°C.

Power: ac line; 48–440 Hz; 86–250 V.

Battery: rechargeable lead-acid 8 hours maximum continuous operation with full charge. Recharge time: 16 hours operating, 12 hours non-operating.

Size: 3466A: 98.4 mm H x 238.1 mm W x 276.2 mm D (3.88" x 9.38" x 10.88").

Weight: 3466A: 2.9 kg (6.31 lb). 3466A Opt 001: 2 kg (4.41 lb).

Ordering Information

3466A streamlined portable case with handle, AC line power. Batteries and charger included. Test leads included. (standard configuration)

3466A Opt. 001, streamlined portable case, AC line power only.

3466A Opt. 002, Rack and Stack case, AC line power only. (Rack mount kit not included.)

All orders must include one of the power options: 86–106 V Opt. 100; 190–233 V Opt. 210; 104–127 V Opt. 115; 208–250 V Opt. 230.

3466A Digital Multimeter

DIGITAL VOLTMETERS

Low Cost 3½ to 5½ Digit HP-IB Multimeter

Model 3478A

- 5 measurement functions
- Up to 71 readings/s
- Electronic calibration
- 100 Nanovolt resolution

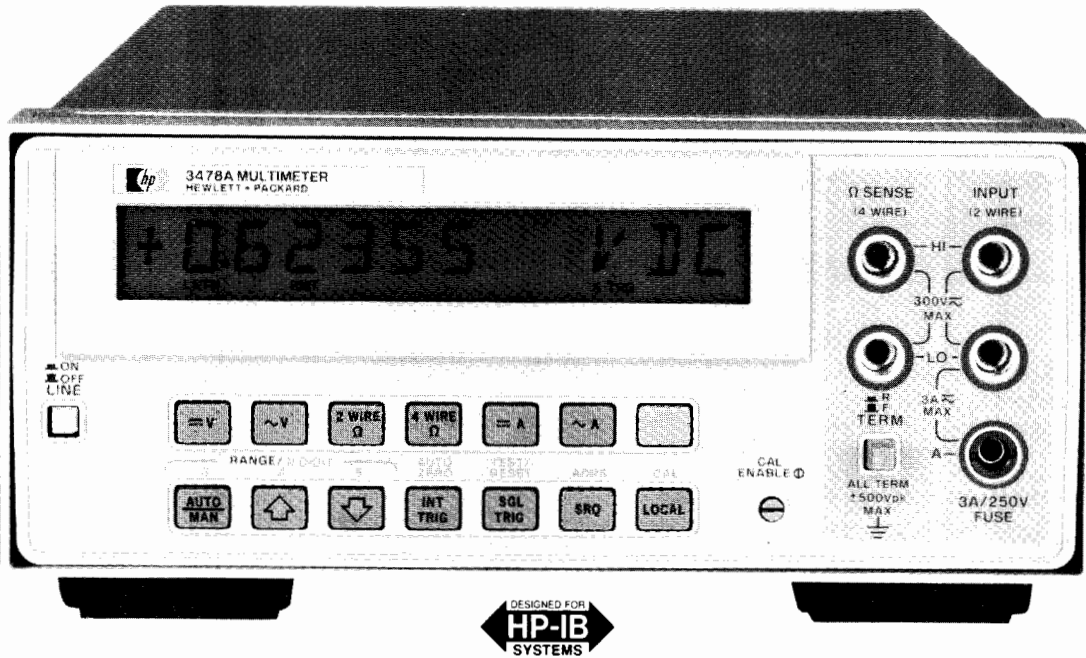

Description

The 3478A provides a low cost, completely HP-IB programmable solution for system measurements. Selectable 3½ to 5½ digit resolution and 5 autoranging functions offer flexibility in automated testing. The 3478A can measure DCV, true RMS ACV, 2 and 4 wire ohms, and dc and ac current. Simple, fast electronic calibration eliminates all adjustments to provide a lower cost of ownership.

Performance

Selectable speed and resolution provide the right capability for your measurement. The 3478A can perform production tests or acquire experimental data at 71 readings/sec with 3½ digit resolution, or take 33 readings/sec with 130 dB of noise rejection using 4½ digits. The 5½ digit mode offers 100 nVDC and 100 μΩ resolution for precise measurements. True RMS with 300 kHz bandwidth and 4:1 crest factor provides reliable measurements of ac signals. Fast autoranging makes the first reading useful and accurate.

Designed for Systems

Switchable front/rear inputs permit flexible system connections. The Voltmeter Complete output and External Trigger input allow synchronization of the 3478A with a scanner for fast multiplexed measurements without the delay of software commands. The test program can automatically present messages or results on the alphanumeric liquid crystal display. The operator can then respond by pressing the 3478A's SRQ key to interrupt the controller and start the next test. Built-in self-test capability assures proper operation.

Electronic Calibration

Complete calibration of the 3478A is accomplished without any internal adjustment or removing the instrument's covers. The simple and fast electronic calibration procedure lowers the cost of ownership. You only need to connect standards to the 3478A and store calibration constants in the 3478A's non-volatile memory. Calibration can be done manually from the front panel or automatically using HP-IB.

Specifications

DC Voltage

Input Characteristics

Range	Maximum Reading (5½ digit)	Resolution		
		5½ digit	4½ digit	3½ digit
30 mV	±30.3099 mV	100 nV	1 μV	10 μV
300 mV	±303.099 mV	1 μV	10 μV	100 μV
3 V	±3.03099 V	10 μV	100 μV	1 mV
30 V	±30.3099 V	100 μV	1 mV	10 mV
300 V	±303.099 V	1 mV	10 mV	100 mV

Input resistance: 30 mV, 300 mV, 3 V ranges: > 10¹⁰ Ω
30 V, 300 V ranges: 10 MΩ ± 1%

Maximum input voltage (non-destructive): Hi to Lo: 303 Vrms or 450 V peak; Hi or Lo to Earth Ground: ± 500 V peak

Measurement accuracy: ± (% of reading + number of counts). Auto zero ON.

5½ Digit Mode

Range	T _{Cal} * ± 1°C		T _{Cal} * ± 5°C	
	24 Hour	90 Day	1 Year	
30 mV	0.027 + 35	0.03 + 41	0.04 + 41	
300 mV	0.005 + 4	0.0074 + 5	0.02 + 5	
3 V	0.0034 + 2	0.0059 + 2	0.019 + 2	
30 V	0.005 + 3	0.0074 + 3	0.02 + 3	
300 V	0.0055 + 2	0.0076 + 2	0.02 + 2	

*T_{Cal} is the temperature of the environment where the 3478A was calibrated. Calibration should be performed with the temperature of the environment between 20°C and 30°C.

4½ and 3½ digit mode: accuracy is the same as 5½ digit mode for % of reading; use 1 count for number of counts on all ranges except 30 mV, use 4 counts.



Temperature coefficient: 0° to 55°C, 5½ digits, auto zero ON. ±(% of reading + number of counts)/°C

Range	Temperature Coefficient
30 mV	0.0028 + 5.0
300 mV	0.0005 + 0.5
3 V	0.0004 + 0.05
30 V	0.0006 + 0.5
300 V	0.0004 + 0.05

Noise rejection: in dB with 1 kΩ imbalance in Lo lead. AC rejection for 50, 60 Hz ± 0.1%. Auto zero ON.

Display	AC NMR	AC ECMR	DC CMR
5½ digits	80	150	140
4½ digits	59	130	140
3½ digits	0	70	140

Maximum Reading Rates (readings/s.)

Line Frequency	Auto Zero	Resolution		
		3½ digits	4½ digits	5½ digits
60 Hz	Off	71	33	4.4
	On	53	20	2.3
50 Hz	Off	67	30	3.7
	On	50	17	1.9

AC Voltage (true rms)

Input Characteristics

Range	Maximum Reading (5½ Digit)	Resolution		
		5½ Digit	4½ Digit	3½ Digit
300 mV	303.099 mV	1 µV	10 µV	100 µV
3 V	3.03099 V	10 µV	100 µV	1 mV
30 V	30.3099 V	100 µV	1 mV	10 mV
300 V	303.009 V	1 mV	10 mV	100 mV

Input impedance: 1 MΩ ± 1% shunted by <60 pF

Maximum Input Voltage (non-destructive):

Hi to Lo: 303 Vrms or 450 V peak

Hi or Lo to Earth Ground: ±500 V peak

Measurement accuracy: ±(% of reading + number of counts).

Auto zero ON. 5½ digit display. Accuracy is specified for sinewave inputs only, >10% full scale.

1 YEAR, T_{Cal}* ± 5°C

Frequency	Ranges		
	300 mV	3 V, 30 V	300 V
20-50 Hz	1.14 + 163	1.14 + 102	1.18 + 102
50-100 Hz	0.46 + 163	0.46 + 103	0.5 + 102
100 Hz-20 kHz	0.29 + 163	0.26 + 102	0.33 + 102
20-50 kHz	0.56 + 247	0.41 + 180	0.55 + 180
50-100 kHz	1.74 + 882	1.05 + 825	1.26 + 825
100 k-300 kHz	10.1 + 3720 (30 V range only)		

Crest factor: >4:1 at full scale

Common mode rejection: with 1 kΩ imbalance in Lo lead, >70 dB, at 60 Hz

Maximum reading rates: 3½ or 4½ digits, 1.4 readings/s; 5½ digits, 1.0 readings/s. First reading is correct within 70 counts of final value when triggered coincident with step input. Add 0.6 seconds for each range change.

Resistance (2-wire Ω, 4-wire Ω)

Input Characteristics

Range	Maximum Reading (5½ Digit)	Resolution		
		5½ Digit	4½ Digit	3½ Digit
30 Ω	30.3099 Ω	100 µΩ	1 mΩ	10 mΩ
300 Ω	303.099 Ω	1 mΩ	10 mΩ	100 mΩ
3 kΩ	3.03099 kΩ	10 mΩ	100 mΩ	1 Ω
30 kΩ	30.3099 kΩ	100 mΩ	1 Ω	10 Ω
300 kΩ	303.099 kΩ	1 Ω	10 Ω	100 Ω
3 MΩ	3.03099 MΩ	10 Ω	100 Ω	1 kΩ
30 MΩ	30.3099 MΩ	100 Ω	1 kΩ	10 kΩ

Input protection (non destructive): Hi to Lo: ±350 V peak; Hi or Lo to Earth Ground: ±500 V peak.

Measurement accuracy: ±(% of reading + number of counts). Auto zero ON. 5½ digit display. 4-wire ohms.

Range	T _{Cal} * ± 5°C		
	24 Hour	90 Day	1 Year
30 Ω	0.023 + 35	0.027 + 41	0.034 + 41
300 Ω	0.0045 + 4	0.012 + 5	0.017 + 5
3 k-300 kΩ	0.0035 + 2	0.011 + 2	0.016 + 2
3 MΩ	0.0052 + 2	0.011 + 2	0.016 + 2
30 MΩ	0.036 + 2	0.066 + 2	0.078 + 2

Current Through Unknown

Range	30 Ω	300 Ω	3 kΩ	30 kΩ	300 kΩ	3 MΩ	30 MΩ
Current	1 mA	1 mA	1 mA	100 µA	10 µA	1 µA	100 nA

DC Current

Input Characteristics

Range	Maximum Reading (5½ Digit)	Resolution		
		5½ Digit	4½ Digit	3½ Digit
300 mA	± 303.099 mA	1 µA	10 µA	100 µA
3 A	± 3.03099 A	10 µA	100 µA	1 mA

Maximum input (non-destructive): 3 A from <250 V source; fuse protected.

Measurement accuracy: ±(% of reading + number of counts).

Auto zero ON. 5½ digit display.

Range	T _{Cal} * ± 5°C	
	90 Days	1 Year
300 mA	0.11 + 40	0.15 + 40
3 A (<1 A)	0.14 + 6	0.17 + 6
3 A (>1 A)	1.0 + 30	1.0 + 30

Maximum burden at full scale: 1 V (3 A range), 0.1 V (0.3 A range)

AC Current (true rms responding)

Input Characteristics

Range	Maximum Reading (5½ Digit)	Resolution		
		5½ Digit	4½ Digit	3½ Digit
300 mA	303.099 mA	1 µA	10 µA	100 µA
3 A	3.03099 A	10 µA	100 µA	1 mA

Maximum input: (non-destructive): 3 A from <250 V source; fuse protected.

Measurement accuracy: ±(% of reading + number of counts).

Auto zero ON. 5½ digit display. Accuracy is specified for sinewave inputs only, >10% full scale.

1 YEAR, T_{Cal}* ± 5°C

Frequency	Ranges	
	300 mA	3 A
20-50 Hz	1.54 + 163	2.24 + 163
50-1 kHz	0.81 + 163	1.50 + 163
1 k-10 kHz	0.72 + 163	1.42 + 163
10 k-20 kHz	0.86 + 163	1.56 + 163

Maximum burden at full scale: 1 V (3A range)

General

Operating temperature: 0 to 55°C

Humidity range: 95% R.H., 0 to 40°C

Power: ac line 48 to 440 Hz; 86 to 250 V, 25 VA max.

Size: 102 mm H x 215 mm W x 356 mm D (4" x 8" x 14");

3½ in. H without feet.

Weight: 3 kg (6.5 lbs.)

Ordering Information

Choose one N/C power option:

Opt 315: 100 V, 50 Hz; **Opt 335:** 220 V, 50 Hz

Opt 316: 100 V, 60 Hz; **Opt 336:** 220 V, 60 Hz

Opt 325: 120 V, 50 Hz; **Opt 345:** 240 V, 50 Hz

Opt 326: 120 V, 60 Hz; **Opt 346:** 240 V, 60 Hz

Opt 907: Front Handle Kit (P/N 5061-0088)

Opt 908: Rack Mount Kit (P/N 5061-0072)

Opt 910: Extra Manuals

Model 3478A Multimeter



DIGITAL VOLTMETERS

3 1/2 to 6 1/2 Digit DVM for Bench/System Applications

Model 3456A

- Up to 330 rdgs/s.
- 100 nanovolt resolution
- Transfer standard performance
- 100 micro-ohm to 1.0 gigaohm measurement capability
- Offset compensated ohms (OC Ω)
- Fast ac

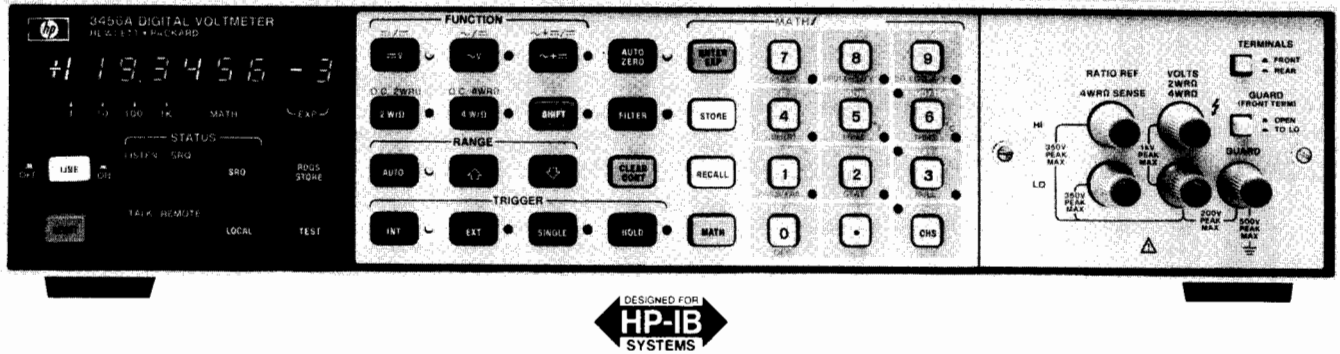

Description

This microprocessor-based, fully guarded, integrating Digital Multimeter is designed for bench or systems. The HP Model 3456A measures dc, true RMS ac voltage and resistance.

Five full scale dc ranges from 0.1 volt to 1000 volts are provided. Measurement speed and accuracy can be enhanced for a specific application, using the HP 3456A's selectable integration time (up to 100 power line cycles) and settling time. An operator can select up to 330 readings/second for high speed bursts or one reading every fifteen minutes for periodic measurements. Resolution of 100 nanovolts at 48 readings/second (6 1/2 digits) to 10 microvolt resolution at 330 readings per second (3 1/2 or 4 1/2 digits) can be selected.

Because the HP 3456A uses an integration technique with features such as "Program Memory" and "Reading Store", the operator can obtain the fastest possible reading rate with the most noise rejection. The first reading is correct, every time. The HP 3456A built-in memory is divided into two parts (Program and Reading Store). This feature lets the operator choose the length of program and the number of readings to be stored. For example, one could store an instrument command string 8 bytes long in program memory with room for 348 stored readings. The size of the HP 3456A memory is 1400 bytes long.

Transfer standard performance is assured with the HP 3456A. With good repeatability and 100 nanovolt sensitivity, accuracy on the ten volt range is $\pm 0.0008\% + 2$ counts over a 24-hour period at 23°C ± 1 °C.

Four full-scale, true TRMS ac voltage ranges are provided, with reading speeds up to 12 per second speed over a 20 Hz to 250 kHz frequency range with 1 microvolt resolution (6 digits). Best accuracy is 0.05%. Crest factor is greater than seven at full scale.

Offset Compensated Ohms

A technique called Offset Compensated Ohms is incorporated in the 3456A. The DMM compensates for any resistance inaccuracies that may be caused from thermally produced offset voltages in the circuit under test. In the ohms function, the instrument first measures the voltage drop across the circuit under test. The voltage measured is stored in the DMM. Simultaneously, the DMM supplies a fixed current through the circuit under test and measures the voltage drop. Since the thermal error first stored in the DMM's memory, it is automatically eliminated from the measurement.

The measurement range is from 1 mΩ to 1.2 GΩ, using either 2 or 4 wire connections.

System DMM

Standard on the 3456A is an isolated HP-IB (IEEE-488) I/O for the systems operation. The front panel indicators on the 3456A display range, function and HP-IB status during remote operation. Also on the front panel is a SRQ (Service Request) button which can be

used to flag or interrupt a computer. With the 3456A's program memory and reading storage capability, system programmers and operators can use only one desktop or minicomputer to control numerous test stations, each containing a 3456A. By depressing the 3456A numerical entry keys and SRQ, the computer can be instructed to transfer a measurement sequence to the 3456A. The 3456A can take measurements and store them while a computer continues its operation as before the SRQ interrupt.

Another system feature of the 3456A is its hardware scanner advance capability for scanned or multiplexed system applications. As soon as the 3456A's measurement cycle is complete, a TTL signal is available to trigger an HP 3495A Scanner or 3497A Acquisition/Control Unit to advance to their next channel. Up to 330 channels can be scanned per second without computer interaction.

Bench DMM

With a 2 ppm stability, the HP 3456A is a true transfer standard offering either 100 nanovolt sensitivity or 0.001% accuracy. Other standard features include fast autorange and easy-to-use math functions. The user can scale, limit test, null and make measurements in percent error, dB and dBm, as well as themistor compensation in degrees F and C. A statistics function key (STAT) enables the operator to improve the 3456A's sensitivity, resolution and accuracy by averaging. Averaging reduces random noise fluctuations and improves sensitivity by a factor of the square root of the number of measurements. For example, for low level signals after 100 measurements, the actual sensitivity of the 3456A is approximately 10 nanovolts instead of 100 nanovolts. In addition, STAT enables the operator to recall the maximum (upper), minimum (lower), and variance.

Calibration of the HP 3456A is fast and convenient since all routine adjustments are accessible from a concealed door in the front panel. Should service be necessary, built-in diagnostics and PC Board modules make the HP 3456A easy to service.

Specifications

DC Voltage Input Characteristics

RANGE	MAXIMUM READING (5 1/2 digit)	6 1/2 digit	RESOLUTION 5 1/2 digit	4 1/2 digit	INPUT IMPEDANCE	MAXIMUM INPUT VOLTAGE
0.1 V	.119999 V	100 nV	1 μV	10 μV	>10 ¹⁰ Ω	±1000 V peak
1.0 V	1.19999 V	1 μV	10 μV	100 μV	>10 ¹⁰ Ω	
10.0 V	11.9999 V	10 μV	100 μV	1 mV	>10 ¹⁰ Ω	
100.0 V	119.999 V	100 μV	1 mV	10 mV	10 MΩ $\pm 5\%$	
1000.0 V	1000.0 V	1 mV	10 mV	100 mV	10 MΩ $\pm 5\%$	

Guard to chassis: ± 500 V peak
Guard to low: ± 200 V peak



Measurement accuracy: \pm (% of reading + number of counts).
Auto-zero on and filter off.

24 hour: 23°C \pm 1°C

RANGE	6½ digit (≥ 10 PLC) ^a	6½ digit (1 PLC)	5½ digit (.1 PLC)	4½ digit (.01 PLC)
0.1 V	.0022 + 24	0.0024 + 32	0.007 + 14	0.06 + 3
1.0 V	0.0009 + 4	0.0012 + 5	0.007 + 3	0.06 + 2
10.0 V	0.0008 + 2	0.0011 + 3	0.007 + 2	0.06 + 2
100.0 V	0.0011 + 3	0.0014 + 4	0.007 + 2	0.06 + 2
1000.0 V ¹	0.0011 + 2	0.0013 + 3	0.007 + 2	0.06 + 2

^aAdd .02 $\left(\frac{\text{Input Voltage}}{1000}\right)^2$ % to % of reading.

Temperature coefficient: \pm (% of reading + number of counts/°C)

RANGE	5½ Digit Display				
	0.1V	1.0V	10.0V	100.0V	1000.0V
Temp Coef.	0.0002 +0.2	0.0002 +0.02	.0002 +0.02	0.0002 +0.02	0.0002 +0.02

For 6½ digits, multiply counts by 10. For 4½ digits, multiply counts by .1

Auto-zero OFF: (5½ digit). For a stable environment $\pm 1^\circ\text{C}$, add 10 counts for 0.1 V range, 1 count for 1 V and 100 ranges, and .1 count for 10 V and 1000 V ranges. For 6½ digits, multiply counts by 10. For 4½ digits, multiply counts for .1.

Filter ON: rejection is > 60 dB at 50 Hz. Add 2 μV for .1 V, 1.0 V and 10 V range and 200 μV for 100 V and 1000 V range.

Response Time

Filter OFF: for preprogrammed settling times (0.0 seconds), error is $< .005\%$ of input voltage step.

Filter ON: for preprogrammed settling times (.65 seconds), error is $< .01\%$ of input voltage step.

NOISE REJECTION (dB) (1 k Ω unbalance in Lo)

	AC ³		DC ECMR
	NMR	ECMR	
.01 PLC or .1 PLC	0	90	140
≥ 1 PLC	60	150	140
≥ 1 PLC with filter	120	160	140

³For 50, 60 Hz (depending on option) $\pm .09\%$

Resistance (2 W $r\Omega$, 4 W $rOC\Omega$, 4 W $rOC\Omega$)

Input Characteristics

RANGE	MAXIMUM READING (5½ digit)	RESOLUTION			CURRENT THROUGH UNKNOWN	MAXIMUM VALID READING VOLTAGE	MAXIMUM OPEN CIRCUIT VOLTAGE
		6½ digit	5½ digit	4½ digit			
100 Ω	119.999 Ω	100 $\mu\Omega$	1 m Ω	10 m Ω	1 mA	12 V	5.5 V
1 k Ω	1199.99 Ω	1 m Ω	10 m Ω	100 m Ω	1 mA	12 V	5.5 V
10 k Ω	11.9999 k Ω	10 m Ω	100 m Ω	1 Ω	100 μA	12 V	5.5 V
100 k Ω	119.999 k Ω	100 m Ω	1 Ω	10 Ω	50 μA	6 V	9.5 V
1 M Ω	1199.99 M Ω	1 Ω	10 Ω	100 Ω	5 μA	6 V	9.5 V
10 M Ω	11.9999 M Ω	10 Ω	100 Ω	1 k Ω	500 nA	6 V	9.5 V
100 M Ω	119.999 M Ω	100 Ω	1 k Ω	10 k Ω	≤ 500 nA ¹	5 V	5.5 V
1 G Ω	1000.00 M Ω	1 k Ω	10 k Ω	100 k Ω	≤ 500 nA ¹	5 V	5.5 V

¹Ohms source is a 500 nA current source in parallel with a 10 M Ω resistance.

Non-destructive overload: 350 V peak

Measurement accuracy: \pm (% of reading + number of counts).
Auto-zero on, filter off, and 4-wire ohms.

24 hour: 23°C \pm 1°C

RANGE	6½ digit (≥ 10 PLC) ^a	6½ digit (1 PLC)	5½ digit (.1 PLC)	4½ digit (.01 PLC)
100 Ω	0.003 + 24	0.003 + 32	0.009 + 14	0.07 + 3
1 k Ω	0.002 + 4	0.003 + 5	0.008 + 3	0.07 + 2
10 k Ω	0.002 + 4	0.003 + 5	0.008 + 3	0.07 + 2
100 k Ω	0.002 + 2	0.003 + 3	0.008 + 2	0.07 + 2
1 M Ω	0.006 + 2	0.006 + 3	0.012 + 2	0.07 + 2
10 M Ω	0.041 + 2	0.041 + 3	0.07 + 2	0.12 + 2
100 M Ω	1.3 + 1	1.3 + 1	1.5 + 1	1.5 + 1
1 G Ω	11 + 1	11 + 1	13 + 1	13 + 1

AC RMS Voltage (ac, ac + dc)

Input Characteristics

RANGE	MAXIMUM READING (5½ digit)	RESOLUTION			INPUT IMPEDANCE	MAXIMUM INPUT VOLTAGE
		6½ digit	5½ digit	4½ digit		
1.0 V	1.19999 V	1 μV	10 μV	100 μV	1 M Ω \pm 5% shunted by <90 pF	± 1000 V peak (700 V rms) 10 ⁶ VHZ
10.0 V	11.9999 V	10 μV	100 μV	1 mV		
100.00 V	119.999 V	100 μV	1 mV	10 mV		
1000.0 V	700.00 V	1 mV	10 mV	100 mV		

Measurement accuracy: \pm (% of reading + number of counts).
Auto-zero on, $> 1\%$ of scale, and dc component $< 10\%$ of ac component.

24 hour: 23°C \pm 1°C

Filter OFF Filter ON	FREQUENCY IN HZ				
	20 to 30	400-20k 30-20k	20k to 50k 20k to 50k	50k to 100k 50k to 100k	100k to 250k 100k to 250k
6½ digit (≥ 1 PLC) ²	.33 + 300	.05 + 440	.15 + 1500	.53 + 2700	5.0 + 6300
5½ digit (.1 PLC)	.34 + 33	.06 + 44	.16 + 150	.54 + 270	5.0 + 630
4½ digit (.01 PLC)	.39 + 5	.11 + 6	.21 + 17	.59 + 29	5.1 + 65

¹Frequencies > 100 kHz are specified for 1.0 V and 10 V ranges only.

²Integration Time in Power Line Cycles (PLC). For 5½ digits, multiply counts by 0.1. For 4½ digits, multiply counts by 0.01.

Guard to chassis: ± 500 V peak

Guard to low: ± 200 V peak

Temperature coefficient: \pm (% of reading + number of counts)/°C. (5½ digit) $\pm (.008 + 6)/^\circ\text{C}$ for DC component $< 10\%$ ac component. Otherwise add $\pm (.008 + 12)/^\circ\text{C}$. For 6½ digit, multiply counts by 10. For 4½ digit, multiply counts by .1.

DC component $> 10\%$ of ac component: (5½ digit) Add $\pm (.05\%$ of Reading + 50 counts) to accuracy. For 6½ digit, multiply counts by 10. For 4½ digit, multiply counts by .1. For signals with no ac component, use the 1 kHz ac spec.

Crest factor: $> 7:1$ at full scale.

Common mode rejection (1 k Ω unbalance in Lo): > 90 dB dc to 60 Hz.

Auto-zero OFF: for stable environment $\pm 1^\circ\text{C}$ no accuracy change.
Response time: for preprogrammed settling times, error is $< .1\%$ of input voltage step.

Filter OFF: 0.06 seconds

Filter ON: .80 seconds

2-Wire ohms accuracy: Same as 4-wire ohms except add a maximum of .2 ohm offset.

Auto-zero OFF accuracy: (5½ digit). For a stable environment $\pm 1^\circ\text{C}$, add 10 counts for 100 Ω range, 1 count for 1 k Ω and 10 k Ω range, and .2 counts for ≥ 100 k Ω range. Changes in lead resistance are not corrected in 4-wire ohms. For 4½ digit, multiply counts by .1. For 6½ digit, multiply counts by 10.



DIGITAL VOLTMETERS

3½ to 6½ Digital DVM for Bench/System Applications

Model 3456A (cont.)

Offset compensated ohms accuracy: same as 2-wire and 4-wire except maximum reading may be reduced by 9% for large offset voltages.

Response time: with preprogrammed settling time and <200 pF of capacitance, first reading is in specification.

Filter is not operational in ohms.

Temperature coefficient: (5½ digits) ± (% of Reading + Number of Counts)/°C

RANGE	100 Ω	1 kΩ	1 MΩ	10 MΩ	100 MΩ	1 GΩ
Temp Coef.	.0004 +.2	.0004 +.02	.0004 +.004	.0010 +.004	.16 +0	1.6 +0

4½ digit: multiply counts by .1; 6½ digit: multiply counts by 10.

Ratio

Type: dc/dc, ac/dc, or (ac + dc)/dc

Method: 4-wire with Volts Lo input common

$$\text{Ratio} = \frac{\text{Signal Voltage}}{\text{Ref. Hi Voltage} - \text{Ref. Lo Voltage}}$$

Signal measurement: Same as dc Volts, ac Volts, or ac + dc Volts

Reference measurement: automatically selects .1 V, 1 V, or 10 V dc. Volts range and a 0.0 msec. settling time. Filter is off.

Maximum Reference Voltages

Ref. Hi: ±12 V

Ref. Lo: ±9% of Ref. Hi

Ref. Hi-Ref. Lo: ±11.9999 V

Protection: ±350 V peak

Accuracy: Total % signal error + total % reference error (same as .1 V, 1 V, or 10 V DC volts)

Reading Rate

Reading rates are with autorange, math, display and filter off. Output is to internal memory using internal trigger and packed mode. Packed output in place of internal memory adds .35 ms; ASCII output adds 2.3 ms.

Rates vs. integration time and auto-zero: dc volts and 100 Ω thru 10 kΩ ranges with preprogrammed settling times (-0.0 s.). Also, ac or ac + dc Volts and 100 kΩ thru 10 kΩ ranges with 0.0 s. delay.

INTEGRATION TIME IN POWER LINE CYCLES (PLC)	RATES			
	Auto Zero OFF		Auto Zero ON	
	60 Hz	50 Hz	60 Hz	50 Hz
0.01 (4½ digit)	330	290	210	180
0.10 (5½ digit)	210	180	120	100
1.00 (6½ digit)	48	40	25	20
10.00 (6½ digit)	5.8	40	2.9	2.4
100.00 (6½ digit)	.57	.47	.29	.24

Memory

Reading store: can store up to 350 readings.

can be recalled from HP-IB interface or front panel

Program memory: can execute an internal program which controls instrument configuration and measurement sequence. Program is input from the HP-IB interface with up to 1400 ASCII characters.

Memory size: total size is 1400 bytes. Memory used is 1 byte per ASCII character + 4 bytes per reading stored.

Math Functions

General: math function specifications do not include error in X (instrument reading) or in entered values (R, L, U, Y, Z). Range of values input or output is 0.000000 x 10⁻⁹ to ±1999999 + 10⁹. Out of range values send "OL" to display and +1999999 x 10⁹ to HP-IB.

Pass/fail: displays "HI" for values upper limit (U), "LO" for values lower limit (L), and X for values between the limits, with no introduced error. SRQ mask can be programmed to respond to out-of-limit conditions.

Maximum execution time: 20 ms

Statistics

$$\text{Mean (M)} = X_1 + \frac{1}{C} \sum_{i=1}^C (X_i - X_1)$$

$$\text{Variance (V)} = \frac{\sum_{i=1}^C (X_i - X_1)^2}{C - 1} - \frac{1}{C} \left[\sum_{i=1}^C (X_i - X_1) \right]^2$$

Maximum (U) and Minimum (L) are the most positive and negative instrument readings, respectively. X is displayed during calculation of statistics.

X₁ is the first reading taken after enabling statistics and is stored in the Z register. The number of readings taken (C) is stored in the count register.

Maximum execution time: 50 ms

Null: X - X₁ (X₁ is the first valid reading taken after enabling null and is stored in the Z register).

Maximum execution time: 15 ms

dBm(R):

$$10 \log \left| \frac{x^2/R}{1 \text{ mW}} \right| \quad R \text{ is the user-entered impedance.}$$

Output range: -280 to +340 dBm

Maximum execution time: 150 ms

Thermistor (F): converts resistance of thermistor HP0837-0164, YSI 44007, Omega UUA35J3, and Fenwal UUA35J1 to temperature in °F.

Output range: -112° to 302° F

Maximum execution time: 100 ms

Scale: (X - Z)/Y

Maximum execution time: 60 ms

$$\text{dB: } 20 \log \frac{X}{Y}$$

Output range: -620 to +620 dB

Maximum execution time: 100 ms

% Error: 100 x (X - Y)/Y

Maximum execution time: 60 ms

(For specifications greater than 24 hours, refer to the data sheet)

General

Operating temperature: 0 to 50°C

Warmup time: one hour to meet all specifications

Humidity range: 95% R.H., 0 to 40°C

Storage temperature: -40 to +75°C

Power: 100/120/240 V +5%, -10%, 48 Hz to 66 Hz line operation, 60 VA; 220 V ±10%, 48 Hz to 66 Hz line operation, 60 VA.

Size: 88.9 mm H x 425.5 mm W x 527.1 mm D (3½" x 16¾" x 20¾")

Weight: net, 10.49 kg (23.13 lbs.). Shipping, 13.35 kg (29.38 lbs.)

Ordering Information

10833A: 1 Meter (39.37 in.) HP-IB Cable

10833B: 2 Meter (78.74 in.) HP-IB Cable

10833C: 4 Meter (157.48 in.) HP-IB Cable

10833D: 0.5 Meter (19.69 in.) HP-IB Cable

03456-90001: Operating information supplement (one furnished with 3456A)

11000A: Test Leads, dual banana both ends

11002A: Test Leads, dual banana to probe and alligator

34111A: High Voltage Probe, 40 kV

Opt 050: Noise rejection for 50 Hz

Opt 060: Noise rejection for 60 Hz

Opt 907: Front handle kit, P/N 5061-0088

Opt 908: Rack flange kit, P/N 5061-0074

Opt 909: Rack flange and front handle kit, P/N 5061-0075

Opt 910: Extra operating & service manual

Model 3456A Digital Voltmeter

DIGITAL VOLTMETERS

High Speed 3½ Digit System Voltmeter

Model 3437A

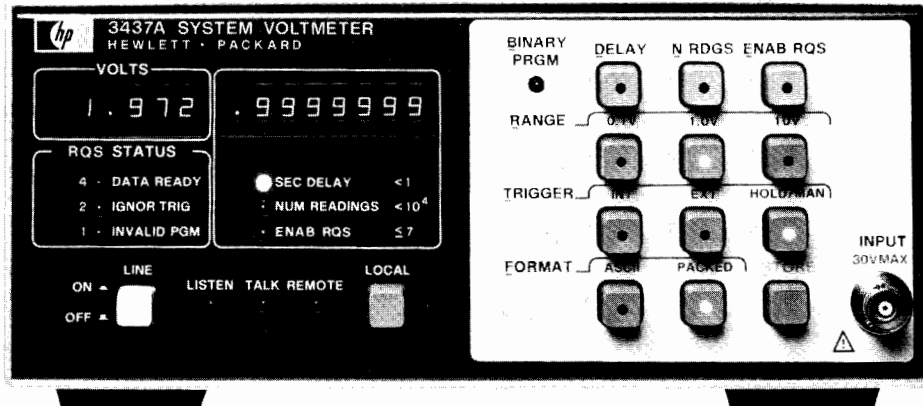

Description

The Hewlett-Packard 3437A System Voltmeter is designed for systems. It is a 3½ digit high speed dc voltmeter with sample and hold. The standard unit measures dc volts, provides trigger delay, burst reading capability and Hewlett-Packard Interface Bus (HP-IB).

There are three dc floating input ranges: 0.1V, 1.0V and 10.0V full scale with a maximum display of "1998." Sample and Hold allow the 3437A to be an instantaneous reading voltmeter. The trigger delay can be set from 0.1µs to 1.0 second and the number of readings can be set from 0 to 9999 readings.

Typical Operation

Example: set Delay to 1 ms and Number of Readings is set to 1000. The 3437A will now take 1000 readings spaced 1 ms apart from one trigger.

Data Output

All front panel switches are programmable from the HP-IB. Two data output formats are available: (1) ASCII output (Serial ASCII characters) and (2) Packed output (two 8-bit bytes on the HP-IB to send the complete reading).

Applications

Waveform analysis—The 3437A can be used to analyze a wide variety of waveforms. The delay and burst reading capability allows frequency, positive or negative peak values, RMS value and harmonic distortion to be measured. The accuracy of these measurements is comparable to more traditional measurement techniques.

Transient signal analysis—The 3437A is capable of measuring transient signals because of the wide bandwidth input (>1 MHz), high measuring speed and sample-and-hold.

Fast AC measurements—Sinusoidal signals of known frequency can be measured in less than one cycle of the signal. Very low frequency measurements can be made more quickly than with conventional techniques.

High speed scanning: multiple input measurement applications can be satisfied with the 3437A and the HP 3497A Data Acquisition/Control Unit. Reading rates of up to 4800 channels/second can be attained.

Data-Sheeted Systems

The 3437A is a component of the 3054A Automatic Data Acquisition and Control System. The 3054A includes the 3437A for high speed measurements, the 3456A Digital Voltmeter for high accuracy measurements and the 3497A Data Acquisition/Control Unit for multiplexing and control outputs. The 3054A includes an extensive software package to support the 3437A when used for thermocouple measurements, high speed scanning, and waveform digitization.

Specifications

DC Volts

Ranges	Max. Display	Overload Reading
10 V	±19.98	±99.99
1 V	±1.998	±9.999
0.1V	±.1998	±.9999

Ranging: manual or remote.

Performance

Static Accuracy (90 days, 23°C ± 5°C)

10 V range: ± (0.05% of reading + 1.6 counts.)

Static Accuracy (1 year, 23°C ± 5°C) V range:

10 V range: ± (0.05% of reading + 2 counts.)

Static accuracy temperature coefficient (0°C–50°C): ± (0.002% reading + 0.05 counts) / °C.

Input Characteristics

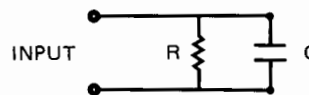

10 V range: R = 1 MΩ ± 20%; C < 75 pF.

Maximum input voltage high to low on all ranges: < ± 30 V peak.

Maximum voltage low to chassis: ± 42 V peak.

Number of readings (N readings): 0 to 9,999.

Readings are not internally stored.

For N = 0 the 3437 operates in delay mode only.

Maximum reading rate (remote, N Rdgs. > 1, and a zero delay listener)

ASCII: 3600 Readings/s.

Packed: 5700 Readings/s.

Delay

N Rdgs. = 0 or 1

DELAY (setting): 0 to 0.999 999 9 sec. in 0.1 µs steps.

N Rdgs. > 1 (remote and a zero delay listener)

ASCII: 0.0002778 s ≤ DELAY ≤ 0.9999999 s.

PACKED: 0.0001754 s ≤ DELAY ≤ 0.9999999 s.

Minimum delay is a function of listener delay related by:

ASCII: 277.8 µs + listener delay.

PACKED: 175.4 µs + listener delay.

Accuracy (EXT. TRIG to DELAY OUT, 0°C to 50°C)

Delay offset: 100 ns ± 25 ns (with < 150 pF cable capacitance)

Delay accuracy: ± 0.008% DELAY Setting + Delay offset.

Delay repeatability (jitter) for N Rdgs = 0 or 1

DELAY of 0 or 0.1 µs: 2 ns

DELAY of 0.2 µs to 50 ms: 10 ns + 0.0002% DELAY setting.

DELAY of > 50 ms: ± 110 ns.

Input Bandwidth (3 dB)

10 V range: 1.0 MHz.

Settling Time

10 V range: 10 V range with 10 V step input:

Reading settles to within 30 mV of final value in 7.5 µs or to within 200 mV of final value in 700 ns.

General

Operating temperature: 0 to 55°C.

Storage temperature: -40°C to 75°C.

Humidity range: < 95% R.H., 0°C to 40°C.

Power: 100 V, 120 V, 220 V, 240 V +5%, -10%, 48 Hz to 440 Hz line operation, < 42 VA with all options.

Size: 88.9 mm H x 212.7 mm W x 527.1 mm D (3½" x 8½" x 20¾").

Weight: net, 5.6 kg (12 lb 4 oz). Shipping, 7.6 kg (16 lb 12 oz).

3437A System Voltmeter

DIGITAL VOLTMETERS

5½ / 6½-Digit DVM with Auto Cal

Model 3455A

- AutoCal
- Self test
- Bench / system

- AC/DC/OHMS
- High speed
- Removable reference

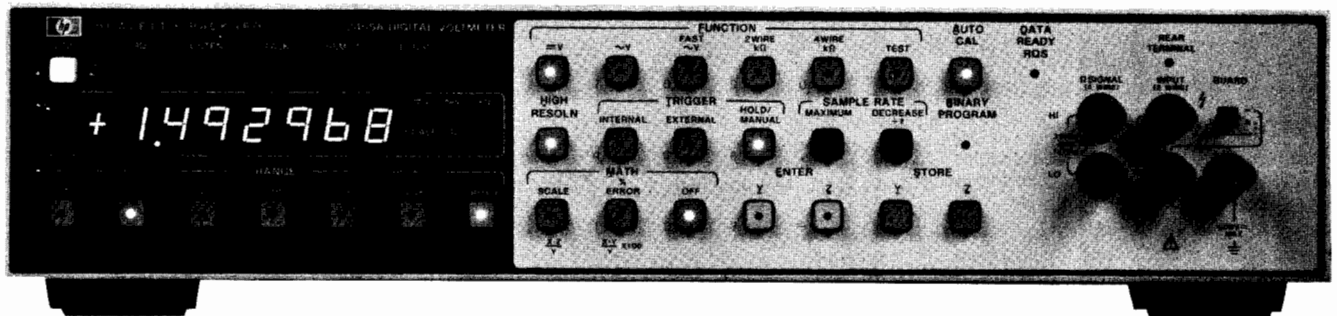

Description

Hewlett-Packard's 3455A Digital Voltmeter is a microprocessor controlled 5½- or 6½-digit integrating voltmeter for bench or systems applications. The standard instrument measures dc volts, ac volts, and resistance. HP-IB I/O for systems applications is also standard.

Measuring Speed

The 3455A is fully guarded and has greater than 60 dB normal mode noise rejection at reading rates of up to 24 readings per second on all dc ranges. Ohms reading rates are up to 12 readings/second and an ac fast mode gives reading rates of up to 13 readings/second at frequencies above 300 Hz. (Readings/seconds given for 60 Hz operation and high resolution off.)

Performance

DC measurements can be made with up to 1µV sensitivity. Ohms measurements are made with either a 2-wire and 4-wire mode. The High Resolution (6½-digit) mode gives dc and Ohms measurements with greater than 1 part per million resolution.

True rms

The standard true rms converter gives ac measurements from 30 Hz to 1 MHz. Complex signals with crest factors of up to 7:1 at full scale can be measured.

Math

The math functions provide computational capability. The Scale mode ($\frac{X}{Y}$) allows the user to offset, take ratios, or scale readings to give readouts in physical units. The % Error mode ($\frac{X-Y}{Y} \times 100\%$) converts readings into percentage change from Y which is entered as a reference. For the math functions X is the present reading. Y and Z are previously entered readings or numbers entered from the front panel or by remote program.

Auto Cal

The auto cal feature gives the user accurate dc volts and ohms measurements and simplifies calibration of these functions. The dc and ohms operating circuits are checked against internal references and any errors are corrected digitally. All dc and ohms adjustments are in a removable reference assembly.

Serviceability

Routine maintenance and calibration has been simplified with the removable reference assembly. Calibration of dc and ohms functions can be done by replacing the reference assembly with a recently calibrated one. Extra reference assemblies are available as HP accessory number 11177A. A spare assembly is ideal for one or more 3455A's. Calibrate dc and ohms in a 3455A without removing it from the bench or system. Just return the extra reference assembly to the cal lab or HP for calibration and have it back in time to calibrate the 3455A next time.

The self-test feature is used to aid in troubleshooting as well as verifying operation of the 3455A. Test verifies proper operation of the dc measuring circuits by comparing their parameters against predetermined limits. If a problem is found, the display is used to assist in finding the problem area by indicating which parameter is in error. Detailed troubleshooting can then be used to quickly isolate the problem.

Specifications

DC Voltage

Ranges		Maximum Display	
0.1	—	±0.149999 V	—
1	1	±1.49999 V	±1.499999 V
10	10	±14.9999 V	±14.99999 V
100	100	±149.999 V	±149.9999 V
1000	1000	±1000.00 V	±1000.000 V

Performance

(high resolution off)

Accuracy ± (% of reading + counts)

24 hrs: 23°C ± 1°C		
Range	High Resolution Off	High Resolution On
0.1 V	0.004 + 4	—
1 V	0.003 + 1	0.003 + 4
10 V	0.002 + 1	0.002 + 3
100 & 1000 V	0.004 + 1	0.004 + 3
90 days: 23°C ± 5°C		
Range	High Resolution Off	High Resolution On
0.1 V	0.007 + 4	—
1 V	0.006 + 1	0.006 + 4
10 V	0.005 + 1	0.005 + 3
100 & 1000 V	0.007 + 1	0.007 + 3

Input Characteristics

Input resistance: 0.1 V through 10 V range: >10¹⁰ ohms. 100 V and 1000 V range: 10 megohm ±0.1% with Auto Cal. "off."

Maximum Input Voltage

- High to low input terminals:** ±1000 V peak.
- Guard to chassis:** ±500 V peak.
- Guard to low terminal:** ±200 V peak.

Normal mode rejection (NMR): NMR is the ratio of the peak normal-mode voltage to the peak error voltage in the reading.

NMR at 50 or 60 Hz ±0.1%: >60 dB.

Effective common mode rejection (ECMR): ECMR is the ratio of the peak common-mode voltage to the resultant peak error voltage in the reading.

ECMR with 1 kΩ Unbalance in Low Lead at

- DC:** >140 dB.
- 50 Hz or 60 Hz ±0.1%:** >160 db.

AC Voltage (rms converter) (high resolution on or off)

Ranges:	1.00000 V	Maximum display:	1.49999 V
	10.0000 V		14.9999 V
	100.000 V		149.999 V
	1000.00 V		1000.00 V

Range selection: Manual, Automatic or Remote.

Function selection: ACV or Fast ACV.

Input Characteristics

Input Impedance

- Front terminals:** 2 MΩ ±1% shunted by less than 100 pf.
- Rear terminals:** 2 MΩ ±1% shunted by less than 75 pf.

Maximum Input Voltage

- High to low terminals:** ±1000 volts peak. Subject to a 10⁷ volts—Hz limitation.
- Guard to chassis:** ±500 V peak.
- Guard to low terminal:** ±200 V peak.

Response Time

ACV and FAST ACV

First reading to <0.1% of step size when triggered coincident with step change when on correct range (for ac signals with no dc component).

Performance (rms converter)

Accuracy: ± [% of reading + counts]¹ (ac coupled)²

Fast ACV	300 Hz to 20 kHz	20 kHz to 100 kHz	100 kHz to 250 kHz	250 kHz to 500 kHz	500 kHz to 1 MHz
	30 Hz to 20 kHz				
24 hours 23°C ± 1°C	0.04 + 40	0.40 + 80	1.80 + 200	4.0 + 400	5.00 + 2600
90 days 23°C ± 5°C	0.05 + 50	0.50 + 100	2.00 + 250	5.00 + 500	6.00 + 3100

¹Guard must be connected to low. Specifications are only for input levels above 1% of range. For AC coupled inputs <1% of full scale: add 20 counts to above accuracy table, except for AC coupled inputs above 50 kHz and <5% of full scale: add 170 counts to above accuracy table. See footnote 2 for ac/dc coupled inputs.

²For any ac/dc coupled input: add (0.05% of reading + 20 counts) to above accuracy table, except for an ac/dc coupled input above 50 kHz and <5% of full scale: add 170 counts to above accuracy table.

³Frequencies of greater than 100 kHz are specified for the 1 V and 10 V ranges only. ⁴Accuracy is not specified if the volt-hz product exceeds 10⁷. For inputs > 500 V, multiply the above tabulated accuracy by $\frac{1500}{1000} \pm 1\text{m}$.

Ohms

Ranges		Maximum Display	
High Resolution Off	High Resolution On	High Resolution Off	High Resolution On
0.100000 kΩ	—	0.149999 kΩ	—
1.00000 kΩ	1.000000 kΩ	1.49999 kΩ	1.499999 kΩ
10.0000 kΩ	10.00000 kΩ	14.9999 kΩ	14.99999 kΩ
100.000 kΩ	100.0000 kΩ	149.999 kΩ	149.9999 kΩ
1000.00 kΩ	1000.000 kΩ	1499.99 kΩ	1499.999 kΩ
10000.0 kΩ	10000.00 kΩ	14999.9 kΩ	14999.99 kΩ

Range selection: manual, Automatic, or Remote.

Performance

Function selection: 2-wire kΩ or 4-wire kΩ.

Accuracy ± (% of reading + counts) 4-wire kΩ

24 hours: 23°C ± 1°C		
Range	High Resolution Off	High Resolution On
0.1 kΩ	0.003 + 4	—
1 kΩ	0.003 + 1	0.0025 + 4
10 kΩ	0.005 + 2	0.0045 + 4
100 kΩ	0.002 + 2	0.0020 + 5
1000 kΩ	0.012 + 5	0.0120 + 4
10,000 kΩ	0.10 + 5	0.1000 + 4
90 days: 23°C ± 5°C		
Range	High Resolution Off	High Resolution On
0.1 kΩ	0.005 + 5	—
1 kΩ	0.005 + 1	0.0035 + 5
10 kΩ	0.007 + 2	0.0060 + 5
100 kΩ	0.004 + 2	0.0035 + 6
1000 kΩ	0.014 + 5	0.0135 + 5
10,000 kΩ	0.100 + 5	0.1000 + 5

2-wire kΩ: all accuracy specifications are the same as 4-wire kΩ except add 0.0004 kΩ to all readings.

Input Characteristics

Maximum voltage generated across unknown: <5 volts for open circuit; <4.7 volts for valid reading.

Signal source driving unknown (nominal): 0.1 kΩ, 1 kΩ & 10 kΩ ranges.

Overload Protection

Non-destruction: ±350 V peak.

Maximum Reading Rates for Remote Operations. (readings/s)

Function	High Resolution ON		High Resolution OFF	
	50 Hz	60 Hz	50 Hz	60 Hz
DCV	5	6	22	24
Ohms	2.5	3	11	12
ACV (rms)			1.1	1.3
Fast ACV (rms)			1.2	1.3
ACV (Ave)			1.1	1.3
Fast ACV (Ave)			1.2	1.3

Math

Scale ($\frac{X-Z}{Y}$): X is present reading. Y and Z are previously entered readings, or numbers entered from the front panel or by external program.

Maximum number (entered or displayed): ±199,999.9.

Accuracy: ± (Accuracy of X reading ± 1 digit of displayed answer). This assumes no "Y" or "Z" error.

%Error ($\frac{X-Z}{X} \times 100\%$): X is present reading. Y is a previously entered reading, or number entered from the front panel or by external program.

Maximum number (entered or displayed): ±199,999.9.

Accuracy: ± (Accuracy of X reading ± 1 digit of displayed answer). This assumes no "Y" error.

How to Enter Numbers in "Y" or "Z"

- From a current displayed reading:** press STORE "Y" or "Z".
- From front panel:** press ENTER "Y" or "Z". The front panel is now set for numerical entry. These numbers are in blue next to the keys. Enter number and press STORE "Y" or "Z".
- By remote program:** send program codes for equivalent front panel operations.

General

Power: 100 V, 120 V, 240 V +5% -10%, 48 Hz to 400 Hz line operation; <60 VA with all options.

Size: 88.9 H x 425.5 W x 527.1 mm D (3.5" x 16.75" x 20.75").

Weight: net, 9.38 kg (20.7 lb). Shipping, 11.8 kg (26 lb).

Options

001: Average converter

3455A Digital Voltmeter

DIGITAL VOLTMETERS

True RMS Voltmeter
Model 3403C

- DC and 2 Hz to 100 MHz
- 3½ digit



Description

The Model 3403C is usable from dc to 100 MHz. True rms is especially valuable for measurements of noise, multiplexed signals, modulated waves and signals with high harmonic content.

dB Display

The dB display option provides readings directly in dB, a major convenience to ac users. The dB reference to which the measurement is made is conveniently adjustable from the front panel to provide referenced dB measurements, or to provide a convenient means to offset the reading by as much as 13 dB for unreferenced measurements.

Specifications

Ranges

Full range display: 10.00 mV (ac only); 100.0 mV; 1.000 V; 10.00 V; 100.0 V; 1000 V.

Overrange: >90% on all ranges except as limited by max input voltage.

Ranging information: front panel annunciators indicate overrange (approximately 190% of full range), or underrange (approximately 17% of full range) conditions.

Performance

AC Frequency Range

Slow response: 2 Hz to 100 MHz.

Fast response: 25 Hz to 100 MHz.

Response Time

Fast response: 1 s.

Slow response: 10 s.

Instrument reads final reading $\pm 0.1\%$ of input change in stated response time.

Display Rate

Fast response: 4 readings per s.

Slow response: 2 readings per s.

Functions

DC: responds to dc component of input signal.

AC: responds to true rms value of ac coupled input signal.

AC+DC: responds to true rms value of dc and ac input signal; reading is $\sqrt{(dc)^2 + (ac\ rms)^2}$

Temperature coefficient: $\pm(0.1 \times \text{reading accuracy} / ^\circ\text{C})$ outside the $25^\circ\text{C} \pm 5^\circ\text{C}$ temperature range.

Accuracy: 90 days ($25^\circ\text{C} + 5^\circ\text{C}$, <95% RH, 17% of range to 190% of range).

*Data from accuracy charts.

READING ACCURACY = $\pm(\% \text{ OF RANGE} + \% \text{ OF READING})^{**}$

RANGE	% OF RANGE (VOLTS)			% OF READING (VOLTS)					
	DC	DC-AC	AC	DC	25 Hz	100 kHz	1 MHz	10 MHz	100 MHz
1000V	.3	.3	.3	.2	.4*	.2			
100V	.2	.2	.2	.2	.4*	.2	1		
10V	.2	.2	.2	.2	.4*	.2	.5	1	
1V	.2	.2	.2	.2	.4*	.2	.5	1	2 5 10
100mV	.6	.6	.2	.2	.4*	.2	.5	2	2 5 10
10mV			.2				.3	1.2	3

CAUTION: frequencies and ranges in this area may result in invalid readings without ranging indication.

* DC + AC function and slow response time only

** % of reading specification is representative of typical flatness.

Input Characteristics

Input impedance: (< 10 MHz)

1 V to 1000 V range: $10\ \text{M}\Omega \pm 10\%$ shunted by $24\ \text{pF} \pm 10\%$.

10 mV and 100 mV range: $20\ \text{M}\Omega \pm 10\%$ shunted by $20\ \text{pF} \pm 10\%$.

Maximum Input Voltage

High to low: 1000 V rms, 1500 peak or $10^\circ\ \text{V-Hz}$ on any range. Maximum dc voltage in ac mode: 500 V dc.

Low to chassis: $\pm 500\ \text{V}$ dc, when floated with special banana to BNC adapter.

Options:

Autoranging (3403C option 001)

Automatic ranging: uprange at approximately 190% of full range; downranges at approximately 17% of full range.

Autorange time: fast response: 1 s per range change. Slow response: 10 s per range change.

Remote control + digital output + autoranging (3403C option 003): Provides remote control of all front panel functions, ranges, digital output and autoranging.

dB Display (3403C option 006)

Measurement range: 108 dB ($-48\ \text{dBV}$ to $+60\ \text{dBV}$).

Calibrated dB reference: $0\ \text{dB} = 1.000\ \text{V}$; reference level may be set for 0 dBm ($600\ \Omega$) by adjusting front panel dB calibration adjustment.

Variable dB reference: reference level may be shifted downward from calibrated position >13 dB.

General

Operating Conditions

Temperature range: 0°C to 50°C .

Humidity: <95% RH.

Recorder Output

Output voltage: 1 V dc open circuit for full range input.

Output resistance: $1\ \text{k}\Omega \pm 10\%$.

Power: 115 V or 230 V $\pm 10\%$, 48 Hz to 440 Hz, 35 VA max. (including all options).

Input terminals: BNC front panel connector standard for low to high terminals; rear panel connector available by internally reversing position of ac converter module.

Weight: including all options: net, 5 kg (11 lb). Shipping, including all options: Net, 7.2 kg (16 lb).

Size: 127 H x 234.9 W x 196.8 mm D ($5'' \times 9.25'' \times 7.75''$).

Accessories furnished: floating adapter-banana to BNC.

3403C True RMS Voltmeter

Opt 001 autoranging

*Opt 003 remote control + digital output + autoranging

*Opt 006 dB display

*Options 003 and 006 are available only as factory installed options.

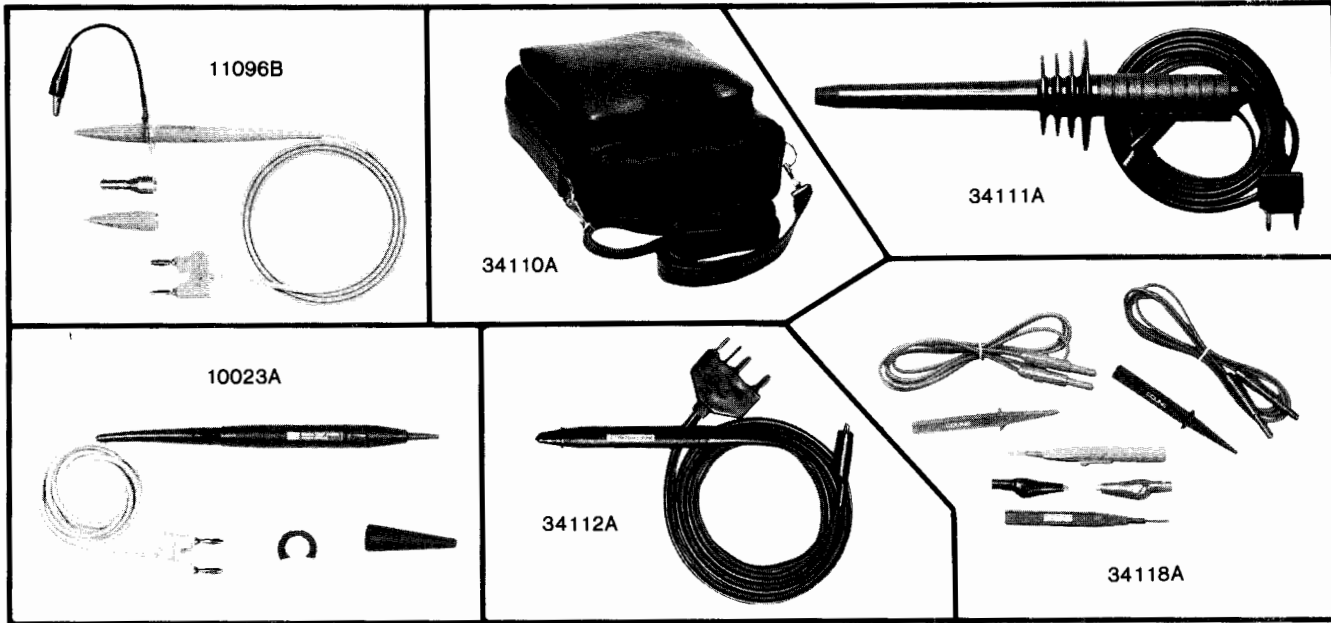

10023A Temperature Probe

The Model 10023A Temperature Probe provides the fast, accurate temperature measurements needed in a wide variety of thermal design, diagnostic, and testing applications. Surface temperature measurements are read directly in degrees Celsius on general purpose digital multimeters having an input impedance of ≥ 10 megohms. A pencil-like probe tip easily accesses small components and a press-to-read switch makes measurements easy.

The probe is a self-contained temperature-to-voltage transducer with a forward-biased diode chip providing calibrated linear output of $1 \text{ mV}/^\circ\text{C}$. The entire electronics assembly, including integrated circuits and battery is packaged in the probe barrel.

A standard dual banana plug output connector provides universal connection to digital voltmeters.

10023A Specifications

Electrical

Measurement range: -55°C to $+150^\circ\text{C}$.

Output: $1 \text{ mV}/^\circ\text{C}$.

Short term repeatability: $\pm 0.3^\circ\text{C}$ (minimum of 48 hrs).

Accuracy: $\pm 2^\circ\text{C}$ from 0°C to 100°C , decreasing linearly to $+2^\circ\text{C}$, -4°C at -55°C and $+4^\circ\text{C}$, -2°C at $+150^\circ\text{C}$.

Maximum voltage at tip: 600 V (dc + peak ac).

Tip capacitance to ground: approx 0.5 pF.

Thermal response: $< 3 \text{ s}$ to settle within 2°C of final reading (liquid measurement) for a 100°C temperature change.

DMM input r: $\geq 10 \text{ M}\Omega$

General

Operating environment (probe tip to approx 13 mm (0.5 in.) from probe tip): temperature, -55°C to $+150^\circ\text{C}$; altitude, to 4600 m (15 000 ft); vibration, vibrated in three planes for 15 min. each with 0.38 mm (0.015 in.) excursion, 10 to 55 Hz.

Operating environment (probe body): temperature, 0°C to 60°C (battery limitation); humidity (non-condensing), to 95% relative humidity at $+40^\circ\text{C}$, altitude and vibration same as those for probe tip.

Overall length: approx 1.4 m (53 in.).

Weight: net, 85 g (3 oz); shipping, 312 g (11 oz).

Battery life: approx 50 hr (varies with ambient temperature).

Accessories supplied: one replacement battery (1420-0256), one sliding lock collar (10023-23201), and one probe tip cover (00547-40005).

Ordering Information

10023A Temperature Probe

10023-60001 Replacement tip, includes pre-calibrated tip and matching compensation network

11096B High Frequency Probe

11096 B High Frequency Probe

Converts dc voltmeter with $10 \text{ M}\Omega$ input to high-frequency ac voltmeter. Works with any dc voltmeter with $10 \text{ M}\Omega$ input impedance.

11096B Specifications

Voltage range: 0.25 to 30 V rms.

Transfer Accuracy (when used with $10 \text{ M}\Omega \pm 10\%$ dc voltmeter)

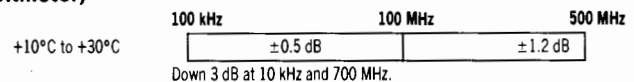

Response: peak responding. Calibrated to read rms value of sine wave.

Input impedance: $4 \text{ M}\Omega$ shunted by 2 pF.

Maximum input: 30 V rms ac; 200 V dc.

Accessories furnished: high-frequency adapter; straight tip; hook tip; ground lead.

34110A Soft Vinyl Carrying Case

Carrying case for $\frac{1}{2}$ rack size instruments. Inside dimensions of 25.4 cm x 22.9 cm x 10.2 cm or 10" D x 9" W x 4" T. Zipper flip top lid and zippered accessory pouch. Has shoulder carrying strap.

34111A DC Hi-Voltage Probe

1000:1 divider will accept up to 40 kV. Input $Z = 10^8 \Omega$. Divider accuracy meets specifications when connected to $10 \text{ M}\Omega$ input resistance instrument.

Division Ratio Accuracy

0–20 kV	$< 4\%$	Divider has interchangeable hook and pointed tip.
30–40 kV	$< 4\%$	
20–30 kV	$< 2\%$	

34112A Touch-Hold Probe

Allows user to hold DMM display by depressing button on probe body. Both ac and dc voltage up to 1200 V max. dc or ac RMS may be measured and held. Usable on the 3435A, 3438A, 3465A/B, and 3466A.

Ordering Information

34110A Carrying Case for $\frac{1}{2}$ Rack Size Instruments

34111A dc Hi-Voltage Probe

34112A Touch-Hold Probe

34118A Test Lead Kit



General Information

C, R, L, D, Q, Z, θ and IC's

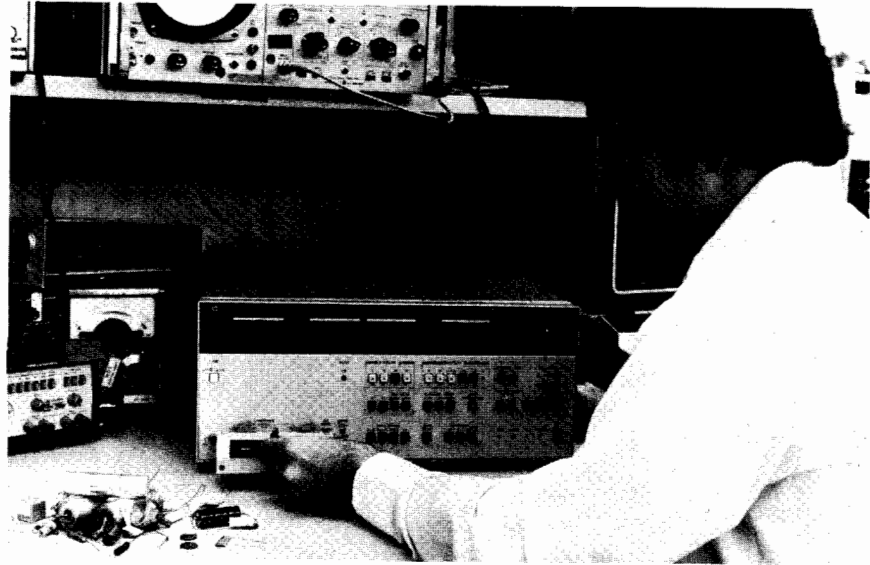

Instrument	Frequency				Q or 1/D		C in farads, L in henries or R in ohms							Basic Accuracy			Page	
	1 DC Hz	1 kHz	1 MHz	1 GHz	10 ⁰	10 ³	10 ⁻¹⁵	10 ⁻¹²	10 ⁻⁹	10 ⁻⁶	10 ⁻³	10 ⁰	10 ³	0.1%	1%	10%		
Multi-frequency LCR Meter 4274A		•	•						C			L	R					100
Multi-frequency LCR Meter 4275A		•	•						C			L	R					100
LCZ Meter 4276A		•	•						C			L	Z					104
LCZ Meter 4277A		•	•						C			L	Z					104
RF Impedance Analyzer 4191A				10 ⁻³					C			L	R, Z					108
LF Impedance Analyzer 4192A		•	•						C			L	Z, R					110
Vector Z Meter 4193A			•										Z			•		112
Digital LCR Meter 4261A		•	•						C			L	R					114
Digital LCR Meter 4262A		•	•						C				R					114
1 MHz C Meter / C-V Plotter 4280A									C				G					116
Q Meter 4342A			•						C			L					•	118
Milliohm Meter 4328A			•									R					•	119
High Resistance Meter 4329A*	•											R					•	119
Vector Z Meter 4800A		•	•						C			L	Z				•	120
pA Meter / DC Voltage Source 4140B*	•								C			I	V				•	122
Semiconductor Parameter Analyzer 4145A*	•											I	V				•	124
Semiconductor / Component Test System 4061A	•		•	•					C			I	V				•	126
Semiconductor Parametric Test System 4062A	•		•	•					C			I	V				•	128
Digital IC Tester 5045A / 5046A	Functional and dc Parameter measurements on TTL, CMOS, ECL, HTL, and DTL logic families.																130	

*I in amperes, V in volts; (V is test voltage).



Impedance |Z|, θ , C, R, L, D & Q

Hewlett Packard's family of component measurement instruments covers the impedance range from less than one milliohm to greater than 10^{16} ohms. Instruments range from the traditional manual null measurement technique to the completely automatic, microprocessor controlled, systems oriented type.

The basic characteristics of each instrument are summarized in the selection guide on the preceding page.

Impedance Considerations

Impedance measuring instruments can be categorized, according to the technique used, into the bridge, voltage/current and Q methods. In the bridge technique, circuit conditioning required to achieve a balance or null condition is detected and processed to indicate the measured value. The voltage/current method essentially uses Ohm's Law in that a constant voltage or current is applied to the unknown and the converse current or voltage is indicative of the unknown value. The Q method utilizes unique characteristics of the series resonant circuit to determine Q, and indirectly L, C and R.

New Generation Component Measurements

Many of these measurements have been either not practical, very difficult, or very costly to make with earlier instruments that were designed to make measurements only under relatively limited test conditions. However, Hewlett-Packard now offers a new generation of instruments to change the measuring concept of evaluating electronic components, devices and circuits—that is, "testing and evaluating under actual working conditions."

The addition of the HP 4274A and 4275A will allow the user to test components under actual operating conditions. Both instruments feature variable test signal levels, ten spot frequencies, self test capability, digital offset to compensate for test leads and fixtures, and vector/phase angle measurements.

The HP Models 4276A and 4277A LCZ Meters are recent additions to HP's line-up of component measuring instruments. Both instruments are capable of high speed LCZ measurements under real-world frequency conditions and both have an optional comparator for fully automatic bin sorting. These features, along with $4\frac{1}{2}$ digit resolution and a basic measurement accuracy of 0.1%, make the 4276A and 4277A ideal for either production line or R & D applications.

Impedance analysis and network analysis can be performed accurately and efficiently using the HP Model 4191A RF Impedance Analyzer and the new HP Model 4192A LF Impedance Analyzer.

In the frequency range of 1 MHz to 1000 MHz, the 4191A measures 14 parameters including |Z|, |Y|, θ , R, X, G, B, L, C, D, and Q, reflection coefficient | Γ |, | Γ_x |, and | Γ_y | plus deviation Δ and $\Delta\%$ for all parameters. The 4192A measures all the preceding parameters plus Group Delay in the frequency range from 5 Hz to 13 MHz.

Both 4191A and 4192A have built-in frequency synthesizers and dc bias sources, including internal sweep of both frequency and bias voltage. Basic measuring accuracy for the 4191A (1 MHz to 1000 MHz) is 1%. Ba-

sic accuracy for the 4192A (5 Hz to 13 MHz) is 0.3%.

HP's 4193A enables in-circuit measurements of impedance magnitude and phase. The 4193A features a built-in 4 digit synthesizer, sweepable from 400 kHz to 110 MHz. This also offers in-circuit and component impedance evaluation at actual operating frequencies.

Semiconductor Measurements

HP's Model 4280A 1 MHz C Meter/C-V Plotter is a convenient and economical instrument for C-V (Capacitance vs. Voltage)/C-t (Capacitance vs. Time) characteristics evaluation of semiconductor devices. The 4280A combines the capabilities of a capacitance/conductance meter with pulse generator, dc voltage staircase generator and computer. It performs very reliable semiconductor capacitance and conductance measurements by applying internal error compensation which compensates for residual impedances in the test set-up.

Very high speed C-t measurements are featured in the 4280A. Resolution up to 10 milliseconds can be achieved without external equipment. Resolution up to 10 microseconds can be achieved when the 4280A controls an external pulse generator like the HP 8112A. Such high speed testing helps analyze semiconductor imperfections over a wide range of trap levels. This makes the 4280A a valuable tool in semiconductor process evaluation and for new semiconductor device development and process control.

The 4140B pA Meter/dc Voltage Source is a highly accurate test instrument designed for basic dc characteristics measurements such as leakage current, current-voltage characteristics, quasi-static C-V measurements and those others especially required by the semiconductor industry for new device development and for improvement of production yields.

The 4140B makes measurements on electric components and equipment such as for measuring leakage current or insulation resistance to improve product reliability.

The 4140B consists of a very stable picoampere meter with a synchronized, dual programmable dc voltage supply— V_A and V_B (V_A includes staircase capability and ramp voltage generation).

HP's Model 4145A Semiconductor Parameter Analyzer provides complete dc characterization of semiconductor devices and materials. It is a fully automatic, high performance, programmable test instrument designed to measure, analyze, and graphically display a wide range of semiconductor dc characteristics, such as h_{FE} , g_m , and V_{th} .

Device stimulus and parameter measurement are performed by four programmable stimulus/measurement units (SMU), providing automatic, high speed measurements and eliminating instability resulting from connection changes at the DUT. The 4145A also has two voltage sources and two voltage monitors for measurement applications which require more than the four SMUs.

Measurement results are displayed on a built-in 6-inch CRT, and can be dumped directly on to an external digital printer/plotter. A built-in flexible disc drive allows storage of measurement set-ups and measurement results.

Integration into HP-IB System

Adding the HP-IB option to a component measuring instrument enables the instrument to be incorporated into an HP-IB system. This permits high speed measurement of many components along with arithmetic processing of measurement data and greatly increases the efficiency of production line testing of discrete components, of quality assurance tests, or of laboratory evaluations.

For more comprehensive semiconductor measurement, Hewlett-Packard has provided the Model 4061A Semiconductor/Component Test System. The 4061A is a dedicated HP-IB system that performs efficient, automatic evaluation of the fundamental characteristics of semiconductor and electronic components. The 4061A is especially useful for new component/material development, quality control, and in the early stages of semiconductor manufacture, for monitoring and controlling the wafer process.

A wide range of characteristics measurements can be done, including doping profile, surface charge density, minority carrier lifetime and threshold voltage. Software for seven typical applications are provided with the system.

HP's 4062A is a parametric test system for semiconductor wafer processing. It offers broader measurement capabilities, higher accuracy and improved data analysis techniques in wafer characterization and process control.

The 4062A provides a wide range (1 pA to 100 mA, 1 mV to 100 V, 1 fF to 1000 pF) of parametric measurements on the basic elements of any LSI circuit including resistors, capacitors, diodes, transistors and FETs. Automatic measurement of simple parameters, such as current, voltage and capacitance is performed at wafer level through 48-channel Switching Matrix in order to characterize the wafer and monitor the wafer process. Utilizing a specialized desktop computer (HP 9836A) and data reduction technique, such as scatter plots and wafer maps, the 4062A can determine process deficiencies, enhance throughput and improve yield.

Summary

To assist in the selection of an impedance meter suitable for your needs, the following guidelines may be used:

- (1) Choose an instrument capable of measuring your device under frequency, signal level, and dc bias conditions identical to those of the intended application.
- (2) Consider the environmental parameters (lead resistance and inductance, stray capacitance, temperature variations, ...) that will affect your measurement and choose a measurement technique that will tend to counteract them.
- (3) Then select the instrument with the broadest measurement capability within accuracy and cost constraints.

Hewlett-Packard's impedance measuring instruments have been used in numerous diverse applications. If you have an unusual application or need assistance, contact your nearest Hewlett-Packard sales office for information.

COMPONENT & SEMICONDUCTOR MEASUREMENT

Multi-Frequency LCR Meters Models 4274A & 4275A

- Test frequencies - 100 Hz to 100 kHz
- Test signal level - 1 mV to 5 Vrms
- High resolution - 5½ digit: D=0.00001
- Measure L/C - D/Q/ESR/G; |Z| - θ , R-X/B/L/C; Δ LCRZ, $\Delta\%$
- 0.1% basic accuracy

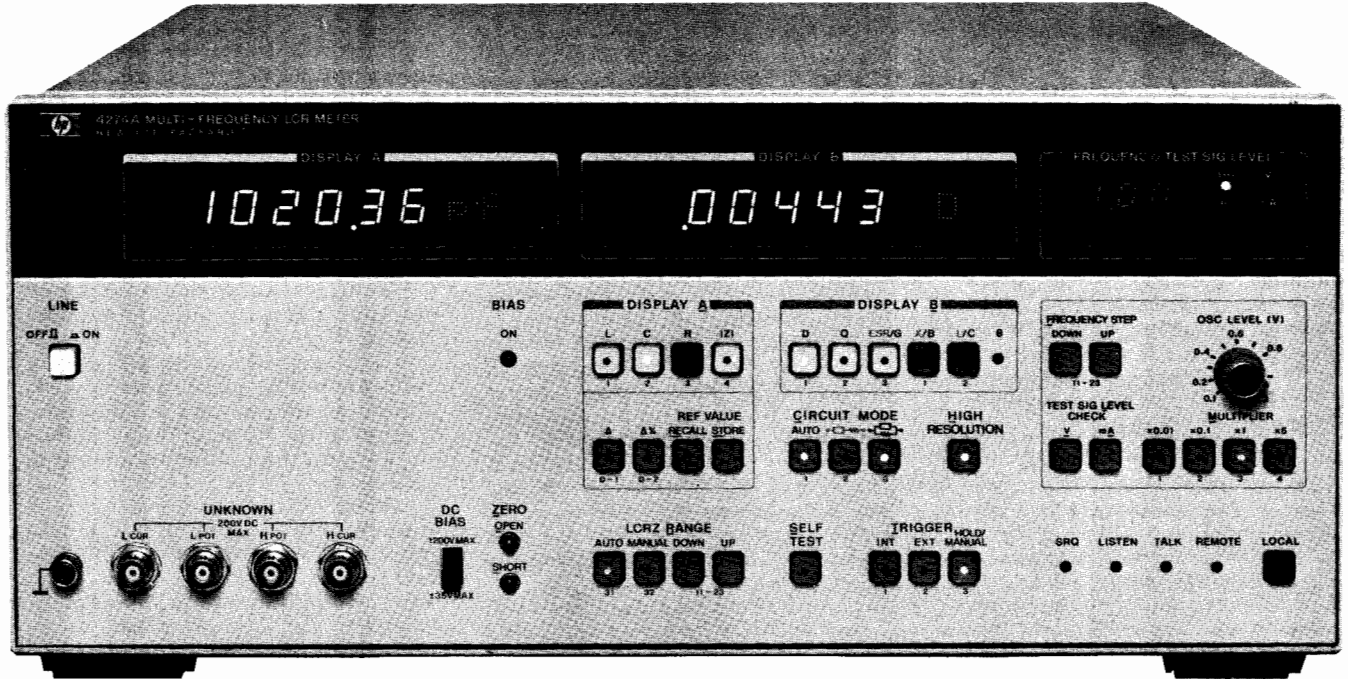

4274A



Description

The 4274A and 4275A Multi-frequency LCR Meters are recent additions to Hewlett-Packard's new generation of microprocessor-based impedance measuring instrumentation. Both instruments offer a new measuring concept for the evaluation of LCR components, complex components, electronic circuits "tested under actual working conditions", and semiconductor materials. A measurement under conditions similar to the intended use contributes to the improvements in quality and reliability of electronic components, devices and circuits.

Multi-Frequency Capability

To insure the high reliability in circuits and devices, it is most important that they be tested and evaluated at test signals similar to those of actual operating conditions.

The 4274A covers the wide frequency range of 100 Hz to 100 kHz in 11 spot frequencies and the 4275A has 10 spot frequencies from 10 kHz to 10 MHz, in 1-2-4 step sequence with 1-3-5 as an option. This feature produces the frequency characteristics of components or devices. In addition, two optional special frequencies (for example: 455 kHz and 10.7 MHz) are available within the frequency range of each instrument. This wide frequency range selection offers evaluation of circuit design with a continuously variable test signal over the range of 1 mV to 5 Vrms (to 1 Vrms for the 4275A), and with internal dc bias optionally available with 1 mV maximum resolution. The test voltage or current values can be monitored on the 3-digit display for accurately setting the actual conditions under which the device-under-test will operate.

Multi-Parameter Measurements

The 4274A and 4275A measure equivalent series resistance (ESR), impedance ($|Z|$), phase angle (θ), reactance (X), susceptance (B), and conductance (G), in addition to the conventional L,C,R,D and Q parameters in certain combinations with a dual 5½ digit display, and an HP-IB option for systems integration.

This wide selection of 11 parameters provides for more accurate evaluation of electronic materials or components with high measurement speed for most needed combined parameters; for example, the C-G measurement of semiconductors, an R-X measurement in circuit design, or the C-ESR or $|Z|-\theta$ measurement of tantalum capacitors.

In addition, a deviation measurement capability ($\Delta, \Delta\%$) for the L.C.R. and $|Z|$ functions displays the difference between the actual value and a stored reference, either as a difference value or in percent. Deviation applications include, for example, a temperature dependence measurement of devices in environmental tests.

Reliable Measurements with 5½ Digit Resolution

The 4274A and 4275A measure only the value of the component and/or device under test, with 5½ resolution and 0.1% basic accuracy by reducing the possibility of errors due to self or mutual inductance, stray capacitance and/or residual inductance in the test leads or test fixture used. This measurement is obtained by a state-of-the-art four terminal pair configuration and a built-in automatic ZERO-offset capability to compensate for these errors.

- Test frequencies - 10 kHz to 10 MHz
- Test signal level - 1 mV to 1 Vrms
- 0.1% basic accuracy
- High resolution - 5½ digit; D=0.00001
- Measure L/C - D/Q/ESR/G; IZI - θ , R-X/B/L/C; Δ LCRZ, $\Delta\%$

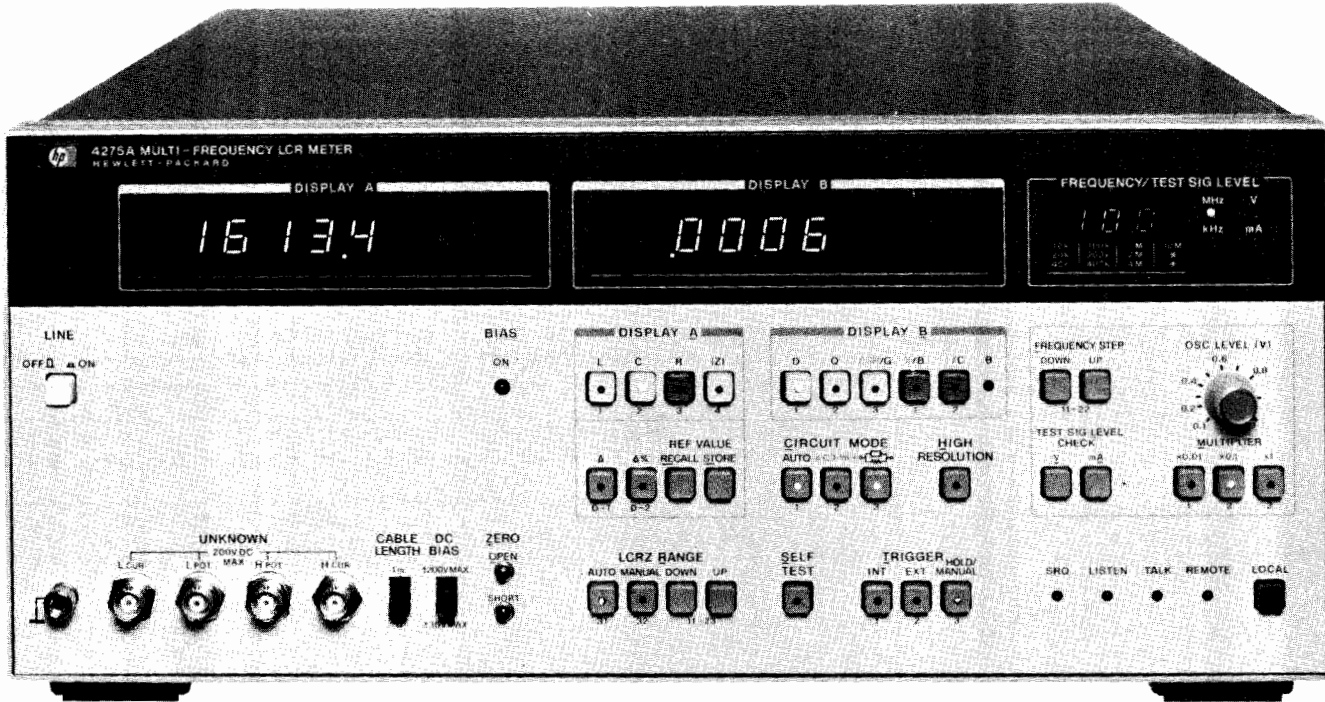

4275A



The fast measurement speed, high resolution, and high accuracy can make major contributions for the component manufacturer and user who is concerned about reducing his costs, improving quality, and throughput efficiency. In these areas, the 4274A and the 4275A are ideal for D-measurements of film capacitors or insulation material (with the high resolution of 0.00001), the C-G measurements of semiconductors (with maximum resolutions of 0.001 pF, 0.1 nS, respectively), and for the low impedance measurement of aluminum electrolytic capacitors (with a maximum resolution of 0.001 m Ω).

Automatic Semiconductor and Component Measurements with HP-IB

Integrating the 4274A and the 4275A into an HP-IB controlled system is an excellent method for improving efficiency and cost savings both in the laboratory and on the production line. These automatic measurement systems are assembled by connecting the HP-IB cables between the instruments to be utilized for a specific task.

A system built around the 4274A and/or 4275A allows the user to obtain useful data for many diverse applications. For example, the evaluation of semiconductors based on the frequency dependence of its C-V characteristics that requires a wide range and fast measurement speeds is easily accomplished with these instruments. The four-terminal pair input configuration and the automatic zero offset capability insures that the measured data is accurate, even in a systems environment.

Sample Applications Semiconductor Measurements

The evaluation of a semiconductor can be done with a C-V or G-V measurement with the multi-spot frequencies featured in the 4274A

and 4275A, (with C resolution of 0.001 pF and G resolution of 0.1 nS), their two programmable bias sources (maximum resolution 1 mV) and their continuously variable test signal levels (from 1 mVrms).

Of significant use is the evaluation of the doping process and the measurement of the characteristics of MOS or bipolar semiconductor materials which employ a C or G measurement with varying dc bias voltage.

A sample plot of a semiconductor measurement is shown in the figure below. Such measurements at high speed can offer high reliability and high throughput efficiency in the semiconductor manufacturing processes.

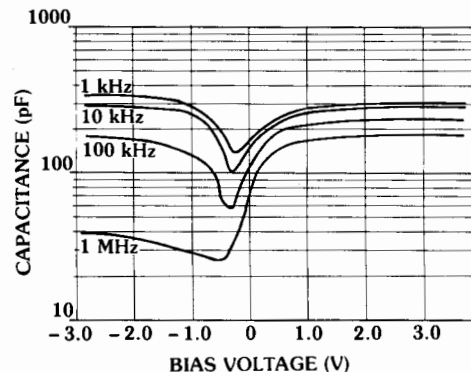



COMPONENT & SEMICONDUCTOR MEASUREMENT

Multi-Frequency LCR Meters

Models 4274A & 4275A (cont.)

Common Specifications (4274A & 4275A)

Parameters Measured

L: inductance C: capacitance	Q: =1/D ESR: equivalent series resistance	θ: phase angle Δ: deviation for L, C, R, Z, Δ%: % of deviation
R: resistance Z: impedance D: dissipation factor	G: conductance X: reactance B: susceptance	Test frequency Test signal level (voltage or current)

Parameter Combinations

Display A	Display B	
L	D / Q / ESR	D / Q / G
C		
R	X / L	B / C
Z	θ	

Measurement Frequencies, Test Signal Levels, and Full Scale Range

MODEL	4274A	4275A
Measurement frequencies	100 Hz–100 kHz, 11 spots (100 Hz, 120 Hz, 200 Hz, 400 Hz, 1 kHz, 2 kHz, 4 kHz, 10 kHz, 20 kHz, 40 kHz, 100 kHz; ±0.01%)	10 kHz–10 MHz, 10 spots (10 kHz, 20 kHz, 40 kHz, 100 kHz, 200 kHz, 400 kHz, 1 MHz, 2 MHz, 4 MHz, 10 MHz; ±0.01%)
Test signal levels	4-ranges (1 mVrms–5 Vrms) continuously variable	3-ranges (1 mVrms–1 Vrms) continuously variable
Full scale range	L: 100.00 nH – 1000.0 H C: 1.0000 pF – 1.00 F R, Z , ESR, & X: 100.00 MΩ – 10.000 MΩ D: 0.00001 – 9.9999 Q (1/D): 0.01 – 9900 G & B: 1.0000 μS – 100.00 S θ: 0 – ±180°	100.00 nH – 10.00 H 1.0000 pF – 100.00 μF 1.0000 Ω – 10.000 MΩ 0.00001 – 9.9999 0.01 – 9900 1.0000 μS – 10.00 S 0 – ±180°

Accuracy (4274A only): typical C–D, L–D, R–X and |Z|–θ measurement accuracy values are given below.

Displays: dual 5½-digit and single 3-digit; maximum display 199999 (full scale and overrange in high resolution mode), and 4½-digit: maximum display 19999 in normal mode. (Number of digits depends on measurement frequency, test level, and range).

Circuit modes: series equivalent circuit and parallel equivalent circuit. Automatic selection available in AUTO mode.

Deviation measurement: difference between recallable stored reference and displayed is deviation value (count or percent).

Display range: –199999 to +199999 counts in AUTO range. –19999 to +199999 counts in MANUAL range (the sample should be measurable at the selected range). % Display range: –199.99% to +199.99%

Ranging: AUTO or MANUAL (UP/DOWN)

Trigger: internal, External or Manual.

Measurement terminals: four-terminal pair with guard.

Auto zero adjustment: automatic normalization of the readout offset due to residuals of the test fixture by pushbutton operation.

Normalization range: C < 20 pF, L < 2000 nH, R < 0.5 Ω, G < 5 μS.

Self test: automatic operational verification check indicates pass or fail condition.

HP-IB data output and remote control: standard.

Memory back-up for storing measurement conditions: standard.

Range: full scale range, accuracy: % of reading + counts (D: accuracy: % of reading + absolute D value + count)

FREQUENCY RANGE	C–D/Q	L–D/Q	R–X	Z –θ
	D-range: 0.00001–9.9999 Q-range: 0.01–9900 (=1/D) (C & D accuracies apply only when C: full scale and D: ≤ 0.1)	D-range: 0.00001–9.9999 Q-range: 0.01–9900 (=1/D) (L & D accuracies apply only when L: full scale and D: ≤ 0.1)	(R accuracies apply only when R: full scale) (X accuracies apply only when R: 1/10 of full scale and X: full scale)	θ-range: –180° – +180.00° (Z & θ accuracies apply only when Z : full scale)
100 Hz 120 Hz	C: 1000 pF–1000 mF, 0.1% + 3 D: 0.33% + 0.0008 + 1	L: 100 μH–10 kH, 0.1% + 3 D: 0.33% + 0.0013 + 1	R: 100 mΩ–10 MΩ, 0.1% + 3 X: 100 mΩ–10 MΩ, 0.1% + 13	Z : 100 mΩ–10 MΩ, 0.1% + 3 θ: ±0.1°
200 Hz	C: 1000 pF–1000 mF, 0.1% + 2 D: 0.32% + 0.0007 + 1	L: 100 μH–10 kH, 0.1% + 3 D: 0.32% + 0.0012 + 1	R: 100 mΩ–10 MΩ, 0.1% + 3 X: 100 mΩ–10 MΩ, 0.1% + 13	Z : 100 mΩ–10 MΩ, 0.1% + 3 θ: ±0.1°
400 Hz	C: 100 pF–100 mF, 0.14% + 1 D: 0.34% + 0.0013 + 1	L: 100 μH–10 kH, 0.1% + 3 D: 0.31% + 0.0011 + 1	R: 100 mΩ–10 MΩ, 0.1% + 3 X: 100 mΩ–10 MΩ, 0.1% + 13	Z : 100 mΩ–10 MΩ, 0.1% + 3 θ: ±0.1°
1 kHz	C: 100 pF–100 mF, 0.1% + 3 D: 0.33% + 0.0008 + 1	L: 10 μH–1000 H, 0.1% + 3 D: 0.33% + 0.0013 + 1	R: 100 mΩ–10 MΩ, 0.1% + 3 X: 100 mΩ–10 MΩ, 0.1% + 13	Z : 100 mΩ–10 MΩ, 0.1% + 3 θ: ±0.1°
2 kHz	C: 100 pF–100 mF, 0.1% + 2 D: 0.32% + 0.0007 + 1	L: 10 μH–1000 H, 0.1% + 3 D: 0.32% + 0.0012 + 1	R: 100 mΩ–10 MΩ, 0.1% + 3 X: 100 mΩ–10 MΩ, 0.1% + 13	Z : 100 mΩ–10 MΩ, 0.1% + 3 θ: ±0.1°
4 kHz	C: 10 pF–10 mF, 0.14% + 1 D: 0.34% + 0.0013 + 1	L: 10 μH–1000 H, 0.1% + 3 D: 0.31% + 0.0011 + 1	R: 100 mΩ–10 MΩ, 0.1% + 3 X: 100 mΩ–10 MΩ, 0.1% + 13	Z : 100 mΩ–10 MΩ, 0.1% + 3 θ: ±0.1°
10 kHz	C: 10 pF–10 mF, 0.1% + 3 D: 0.33% + 0.0008 + 1	L: 1 μH–100 H, 0.1% + 3 D: 0.33% + 0.0013 + 1	R: 100 mΩ–10 MΩ, 0.1% + 3 X: 100 mΩ–10 MΩ, 0.1% + 13	Z : 100 mΩ–10 MΩ, 0.1% + 3 θ: ±0.1°
20 kHz	C: 10 pF–10 mF, 0.1% + 2 D: 0.32% + 0.0007 + 1	L: 1 μH–100 H, 0.1% + 3 D: 0.32% + 0.0012 + 1	R: 100 mΩ–10 MΩ, 0.1% + 3 X: 100 mΩ–10 MΩ, 0.1% + 13	Z : 100 mΩ–10 MΩ, 0.1% + 3 θ: ±0.1°
40 kHz	C: 1 pF–1000 μF, 0.14% + 1 D: 0.34% + 0.0013 + 1	L: 1 μH–100 H, 0.1% + 3 D: 0.31% + 0.0011 + 1	R: 100 mΩ–10 MΩ, 0.1% + 3 X: 100 mΩ–10 MΩ, 0.1% + 13	Z : 100 mΩ–10 MΩ, 0.1% + 3 θ: ±0.1°
100 kHz	C: 1 pF–1000 μF, 0.1% + 3 D: 0.33% + 0.0008 + 1	L: 100 nH–10 H, 0.1% + 3 D: 0.33% + 0.0013 + 1	R: 100 mΩ–10 MΩ, 0.1% + 3 X: 100 mΩ–10 MΩ, 0.1% + 13	Z : 100 mΩ–10 MΩ, 0.1% + 3 θ: ±0.1°

(Conditions: Warm-up time ≥ 30 minutes, environment temperature: 23°C ± 5°C) Refer to technical data sheet for accuracy details.



Accuracy (4725A only): typical C-D, L-D, R-X and $|Z|-\theta$ measurement accuracy values are given below.

Range: full scale range, accuracy: % of reading + counts (D accuracy: % of reading + absolute D value + count)

Frequency Range	C - D/Q	L - D/Q	R - X	$ Z -\theta$
	D-range: 0.00001 - 9.9999 Q-range: 0.01-9900 (= 1/D) (C & D accuracies apply only when C: full scale and D: ≤ 0.1)	D-range: 0.00001 - 9.9999 Q-range: 0.01 = 9900 (= 1/D) (L & D accuracies apply only when L: full scale and D: ≤ 0.1)	(R accuracies apply only when R: full scale) (X accuracies apply only when R: 1/10 of full scale and X: full scale)	θ -range: -180.00° - $+180.00^\circ$ (Z & θ accuracies apply only when Z: full scale)
10 kHz	C: 10 pF - 100 μ F, 0.1% + 3 D: 0.33% + 0.008 + 1	L: 10 μ H - 100H, 0.1% + 3 D: 0.33% + 0.0013 + 1	R: 1000 m Ω - 10 M Ω , 0.1% + 3 X: 1000 m Ω - 10 M Ω , 0.1% + 13	Z: 1000 M Ω - 10 m Ω , 0.1% + 3 θ : $\pm 0.1^\circ$
20 kHz	C: 10 pF - 100 μ F, 0.1% + 2 D: 0.32% + 0.0007 + 1	L: 10 μ H - 100 H, 0.1% + 3 D: 0.32% + 0.0012 + 1	R: 1000 m Ω - 10 M Ω , 0.1% + 3 X: 1000 m Ω - 10 M Ω , 0.1% + 13	Z: 1000 M Ω - 10 m Ω , 0.1% + 3 θ : $\pm 0.1^\circ$
40 kHz	C: 1 pF - 10 μ F, 0.14% + 1 D: 0.34% + 0.0009 + 1	L: 10 μ H - 100 H, 0.1% + 3 D: 0.31% + 0.0011 + 1	R: 1000 m Ω - 10 M Ω , 0.1% + 3 X: 1000 m Ω - 10 M Ω , 0.1% + 13	Z: 1000 M Ω - 10 m Ω , 0.1% + 3 θ : $\pm 0.1^\circ$
100 kHz	C: 1 pF - 10 μ F, 0.1% + 3 D: 0.33% + 0.0008 + 1	L: 1 μ H - 10 H, 0.1% + 3 D: 0.33% + 0.0013 + 1	R: 1000 m Ω - 10 M Ω , 0.1% + 3 X: 1000 m Ω - 10 M Ω , 0.1% + 13	Z: 1000 M Ω - 10 m Ω , 0.1% + 3 θ : $\pm 0.1^\circ$
200 kHz	C: 10 pF - 10 μ F, 0.1% + 2 D: 0.32% + 0.0007 + 1	L: 1 μ H - 1000 mH, 0.2% + 3 D: 0.53% + 0.0023 + 1	R: 1000 m Ω - 1 M Ω , 0.2% + 3 X: 1000 m Ω - 1 M Ω , 0.2% + 13	Z: 1000 M Ω - 1 m Ω , 0.2% + 3 θ : $\pm 0.1^\circ$
400 kHz	C: 1 pF - 1000 nF, 0.14% + 1 D: 0.34% + 0.0009 + 1	L: 1 μ H - 1000 mH, 0.2% + 3 D: 0.51% + 0.0021 + 1	R: 1000 m Ω - 1 M Ω , 0.2% + 3 X: 1000 m Ω - 1 M Ω , 0.2% + 13	Z: 1000 M Ω - 1 m Ω , 0.2% + 3 θ : $\pm 0.1^\circ$
1 MHz	C: 1 pF - 1000 nF, 0.1% + 3 D: 0.33% + 0.0008 + 1	L: 100 nH - 100 mH, 0.2% + 3 D: 0.55% + 0.0025 + 1	R: 1000 m Ω - 1 M Ω , 0.2% + 3 X: 1000 m Ω - 1 M Ω , 0.2% + 13	Z: 1000 M Ω - 1 m Ω , 0.2% + 3 θ : $\pm 0.1^\circ$
2 MHz	C: 10 pF - 100 nF, 0.3% + 3 D: 0.55% + 0.0025 + 1	L: 1 μ H - 10 mH, 0.5% + 5 D: 1.0% + 0.0033 + 1	R: 10 Ω - 100 k Ω , 0.5% + 5 X: 10 Ω - 100 k Ω , 0.5% + 15	Z: 10 Ω - 100 k Ω , 0.5% + 5 θ : $\pm 0.2^\circ$
4 MHz	C: 1 pF - 10 nF, 1% + 20 + 0.002 pF D: 3.3% + 0.01 + 1	L: 1 μ H - 10 mH, 1% + 5 D: 2.0% + 0.0063 + 1	R: 10 Ω - 100 k Ω , 2% + 7 X: 10 Ω - 100 k Ω , 2% + 105	Z: 10 Ω - 100 k Ω , 2% + 7 θ : $\pm 0.8^\circ$
10 MHz	C: 1 pF - 10 nF, 2% + 20 + 0.002 pF D: 4% + 0.011 + 1	L: 100 nH - 1 mH, 2% + 7 D: 3.1% + 0.002 + 1	R: 10 Ω - 100 k Ω , 2% + 7 X: 10 Ω - 100 k Ω , 2% + 105	Z: 10 Ω - 100 k Ω , 2% + 7 θ : $\pm 0.8^\circ$

(Conditions: Warm-up time ≥ 30 minutes, environment temperature: $23^\circ\text{C} \pm 5^\circ\text{C}$) Refer to technical data sheet for accuracy details.

General Information

Test Signal Level Monitor

Model	Range		Accuracy
	Voltage	Current	
4274A	0.001 V - 5.00 Vrms	0.001 mA - 100 mArms	\pm (3% of reading + 1 count)
4275A	0.001 V - 1.00 Vrms	0.001 mA - 10.0 mArms	\pm (3% of reading + 1 count) at < 1 MHz \pm (10% of reading + 2 counts) at ≥ 1 MHz

Measurement time: (typical) 140-180 ms (> 1 kHz); 140-210 ms ≤ 1 kHz (measurement time depends on range, sample value and offset adjustment value).

Z - θ measurement time: 170-210 ms > 1 kHz; 170-240 ms ≤ 1 kHz.

High resolution mode: approximately 8 times the normal measurement time.

Auto ranging time: 100 ms - 300 ms per range change.

Options

Opt 001: 0 to ± 35 internal dc bias

Range	Steps	Accuracy
\pm (.000 - .999) V	1 mV	\pm (0.5% of reading + 1 mV)
\pm (1.00 - 9.99)	10 mV	\pm (0.5% of reading + 2 mV)
\pm (10.0 - 35.0)	0.1 V	\pm (0.5% of reading + 20 mV)

Control: 16023B dc Bias Controller or remote control with HP-IB (opt 101)

Opt 002: 0 - ± 99.9 V internal dc bias (for $C \leq 0.1 \mu\text{F}$)

Range: \pm (00.0 - 99.9) V, 0.1 V steps

Accuracy: \pm (2% of reading + 40 mV)

Control: same as Opt 001

External dc bias: ± 200 V maximum.

Bias monitor: rear panel BNC connector monitors internal or external input bias.

Opt 004: frequency steps in 1-3-5 sequence.

Special Options

One or two arbitrary test frequencies for each instrument are available.

Selectable Frequency Range

4274A: 100 Hz to 100 kHz to $\pm 0.1\%$. If two frequencies are added, at least one frequency must satisfy the following equation: $f = 1200/N$ kHz where N is an integer from 12 to 12000.

4275A: 10 kHz to 10.7 MHz $\pm 0.1\%$.

The following special test frequencies are among those which are available:

Option number	Frequency	Option number	Frequency
F01	15.7 kHz	F14	25.2 kHz
F02	32.8 kHz	F15	79.6 kHz
F03	455 kHz	F16	252 kHz
F04	3.58 MHz	F17	796 kHz
F05	4.19 MHz	F18	2.52 MHz
F06	10.7 MHz	F19	7.96 MHz
F11	15.75 KHz	F21	15.625 kHz
F13	62.5 kHz	F25	63.16 kHz

Accessories

16047A: Direct coupled test fixture. Furnished accessory with the 4274A and 4275A.

16023B: dc Bias Controller, for control of dc bias Opt 001 or 002 Internal Bias Supply when HP-IB option is not installed. Control range 0 to ± 99.9 V by setting thumbwheel switch.

16034B: Test Fixture for chip components

16047B: Test Fixture with Safety Cover

16047C: Test Fixture for high frequencies

16048A: Test leads, BNC

16048B: Test leads, RF miniature

16048C: Test leads with Alligator Clips

Options

Opt 001: 0 to ± 35 internal dc bias, max resolution;

1 mV steps

Opt 002: 0 to ± 99.9 V internal dc bias, resolution: 100 mV steps.

Opt 004: Frequency steps in 1-3-5 sequence

Opt F01-F25: Special test frequencies (each)

Ordering Information

4274A 100 Hz - 100 kHz Multi-Frequency LCR Meter

4275A 10 kHz - 10 MHz Multi-Frequency LCR Meter

COMPONENT & SEMICONDUCTOR MEASUREMENT

LCZ Meters

Models 4276A & 4277A

Model 4276A

- 3-digit frequency setting: 100 Hz to 20 kHz (801 spots)
- High speed measurements (1 kHz): 95 ms/meas (4-digit display resolution); 60 ms/meas (3-digit display resolution)

- Measure L/C-D/Q/ESR/G, $|Z| - \theta$, high speed L/C
- 10-bin component sorting-comparator
- 0.1% basic accuracy over impedance range of 100 m Ω to 10 M Ω

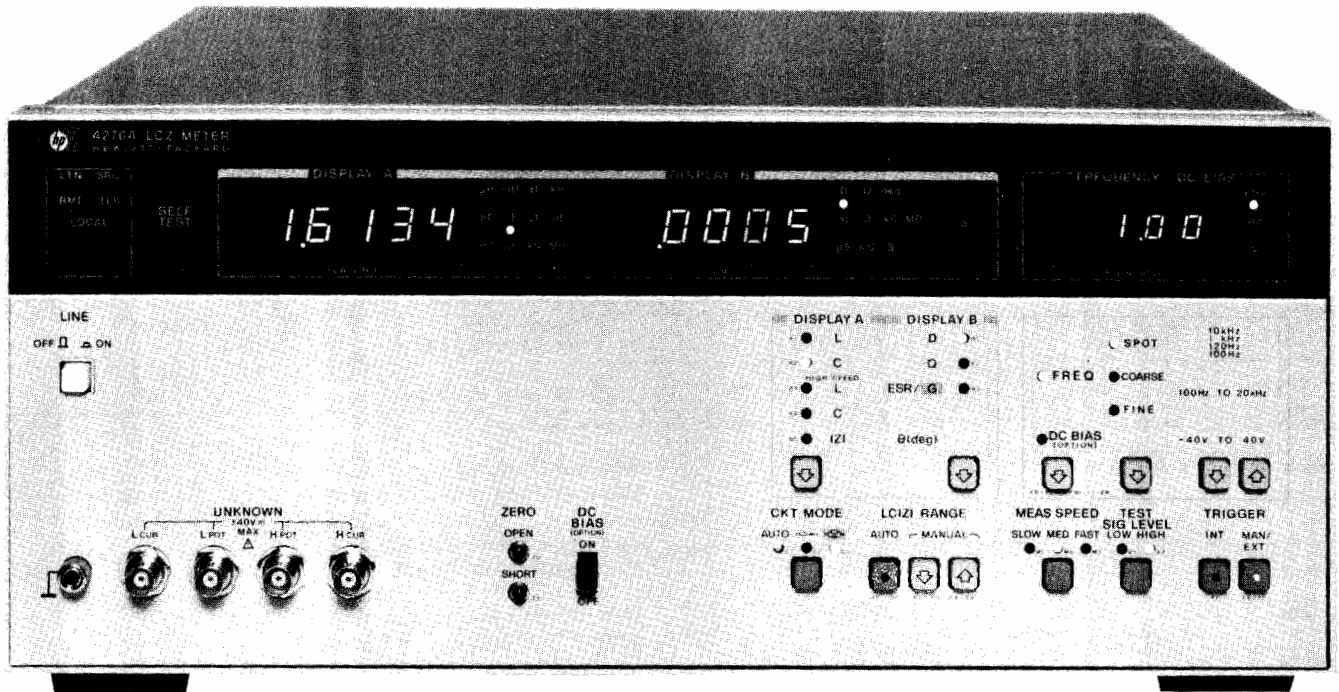

4276A



Description

HP's 4276A and 4277A LCZ Meters are general purpose impedance measuring instruments designed to measure circuit components such as capacitors and inductors using frequency and DC bias conditions identical to those of the intended application. Both 4276A and 4277A feature variable test frequency (100 Hz - 20 kHz and 10 kHz - 1 MHz respectively), optional dc bias variable from 0 to ± 40 V, multiple parameters (L • C • |Z| • D • Q • ESR • G • θ) with fully automatic high speed measurements, and 4½ digit resolution. The 4276A has an impedance range of 100 m Ω to 10 M Ω ; and the 4277A, 10 Ω to 1 M Ω .

Both instruments are ideal for production line, quality control, and circuit design applications, and are versatile enough for stand-alone use or systems use under HP-IB control (standard). An optional comparator for 10-bin sorting with measurement time of less than 100 ms make the 4276A/4277A a good choice for production line testing of discrete components.

Variable Test Parameters: Frequency, Bias, Signal Level

HP's 4276A and 4277A offer variable test frequency, optional internal dc bias, and selectable test signal level (HIGH and LOW). This makes it possible to measure components under conditions almost identical to those of the intended circuit.

The 4276A (100 Hz to 20 kHz) and the 4277A (10 kHz to 1 MHz)

provide 801 and 701 test frequencies, respectively. Test frequencies of both instruments are linearly spaced along a logarithmic scale. The most commonly used test frequencies for production line measurements—100 Hz, 120 Hz, 1 kHz and 1 MHz, all of which are specified in MIL/IEC standards are included. Frequency setting resolution is 3 digits.

Both instruments feature selectable test signal levels—1 V/50 mV (4276A) and 1 V/20 mV (4277A)—and both can be equipped with an optional internal dc bias source that is variable from 0 to ± 40 V in 10 mV (0 to 10 V) or 100 mV (10 to 40 V) steps. Thus, bias conditions that suit the measurement and the DUT can be selected, an important consideration for semiconductor C/V measurements.

The above features satisfy most impedance measurement requirements for component development and circuit design. HP-IB enhances these features.

High Speed Measurements

The 4276A and 4277A provide high speed measurements with 3½ to 4½ digits resolution. The time required for a C-D measurement, for example, is 95 ms (4-digit) or 60 ms (3-digit) at 1 kHz, and 70 ms (4-digit) or 60 ms (3-digit) at 1 MHz. Even at 120 Hz, a measurement time of 170 ms (4-digit) or 150 ms (3-digit) is possible. Also, when the instrument is set to high speed L or high speed C measurement mode, measurement time is 45 ms (4-digit) or 35 ms (3-digit) at 1 kHz (if D is less than 0.002), and 40 ms (4-digit) or 30 ms (3-digit) at 1 MHz (if D is less than 0.01).

Model 4277A

- 3-digit frequency setting: 10 kHz to 1 MHz (701 spots)
- High speed measurements (1 MHz): 70 ms/meas (4-digit display resolution; 60 ms/meas (3-digit display resolution))

- Measures L/C-D/Q/ESR/G, $|Z| - \theta$, high speed L/C
- 10-bin component sorting-comparator (optional)
- 0.1% basic accuracy over impedance range of 10 Ω to 1 M Ω

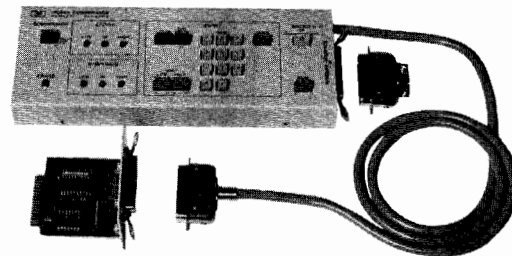
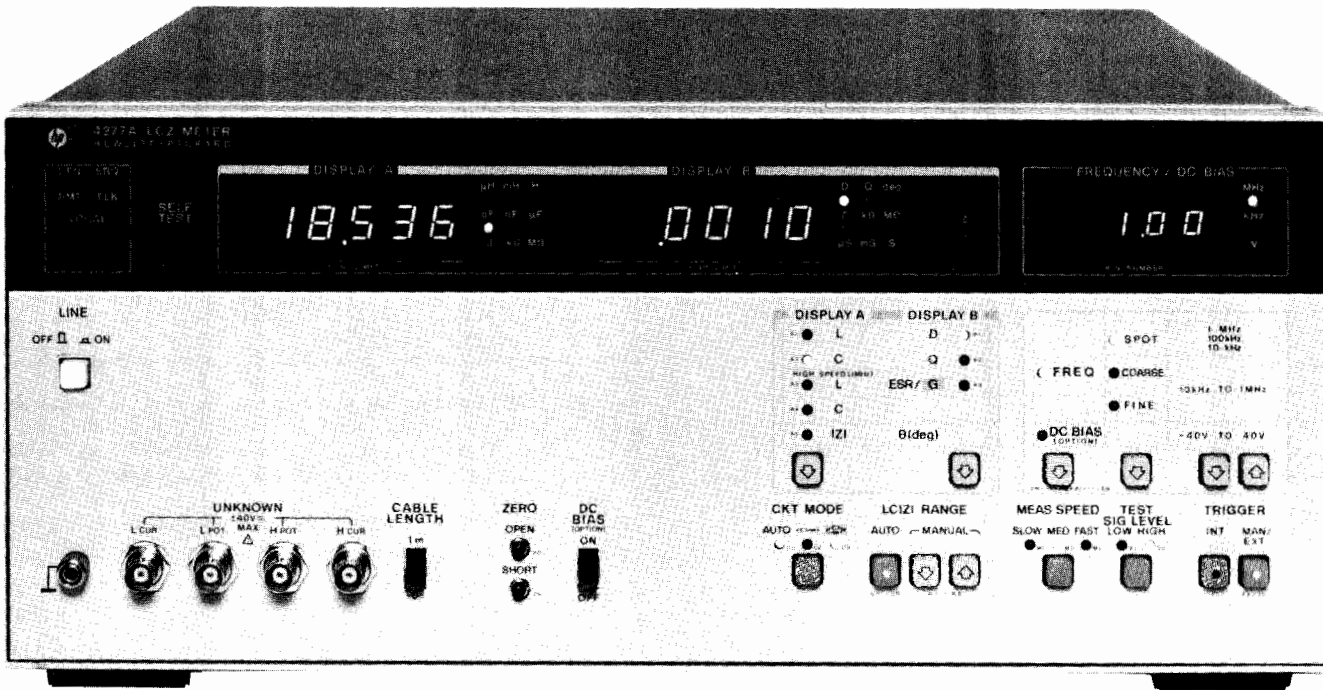

Option 002 Comparator

Such high speeds considerably improve the efficiency and increase the throughput of high volume measurements like outgoing inspection on the production line and incoming inspection by component end users. If an HP-IB system is configured, measurement efficiency is further improved because HP-IB is capable of packed binary data output format, which can be processed much faster than the usual ASCII format. Even when the HP-IB capability is not used, the 4276A/4277A can increase production line throughput if the optional comparator is used.

Optional Ten-Bin Component Sorting

A 10-bin Comparator (option 002) is available. Nine sets of bin limits (high and low) can be input for L, C or $|Z|$. Also, high and low limits for D, Q, ESR, or G can be set to provide go/no-go testing.

Multiple bin sorting is especially beneficial on the production line and in incoming inspection. Test costs can be significantly reduced using the 4276A/4277A's high speed measuring capability. When the optional handler interface is used for automatic component sorting, measurement efficiency is better than that when using HP-IB. This is because time for data handshake is not needed.

Output data from the handler interface is at TTL or open collector level, which improves system noise immunity. Particularly,

three lines—external trigger and measurement complete signals—are photo-isolated, so a reliable sorting system free from noise can be constructed.

Measurement reliability is improved by other comparator features like front panel lock-out and auto zeroing of fixture residuals.

Plus, all comparator functions can be HP-IB controlled. So a fully automatic component sorting system can be constructed for the use in outgoing/incoming inspection.

Specifications (refer to data sheet to complete specifications (Common to 4276A and 4277A))

Parameters measured: C-D•Q•ESR•G
L-D•Q•ESR•G
high speed L, high speed C
 $|z| - \theta$ and Δ (deviation for any parameter)

Display: 4½ digits (max), maximum display 19999

COMPONENT & SEMICONDUCTOR MEASUREMENT

LCZ Meters

Models 4276A & 4277A (cont.)

Measurement circuit modes: Auto, Parallel, and Series

Frequency control modes: SPOT (100 Hz, 120 Hz, 1 kHz, 10 kHz, 100 kHz, 1 MHz), COARSE (10 freqs/decade), and FINE (max. freq. resolution).

Test Signal Level (unknown terminal open)

	HIGH	LOW
4276A	1 Vrms ± 10%*	50 mV ± 20%*(Cp only)
4277A	1 Vrms ± 10%	20 mV ± 15%

*at 1 kHz only

Output impedance: 100 Ω

Ranging modes: Auto and Manual (up-down)

Trigger: Internal, External or Manual

Measurement terminals: 5-terminal (4276A)
4-terminal pair (4277A)

Measurement speed modes: FAST, MED, and SLOW

Offset adjustments: front panel OPEN and SHORT adjustments to compensate for residual impedance and stray admittance of the test fixture.

Test frequencies: 4276A - 100 Hz to 20 kHz ± 0.01% (801 points)

4277A - 10 kHz to 1 MHz ± 0.01% (701 points)

Step Frequency

Test Frequency	Step Frequency
100 Hz-200 Hz	1 Hz
202 Hz-500 Hz	2 Hz
505 Hz-1 kHz	5 Hz
1.01 kHz-2 kHz	10 Hz
2.02 kHz-5 kHz	20 Hz
5.05 kHz-10 kHz	50 Hz
10.1 kHz-20 kHz	100 Hz
20.2 kHz-50 kHz	200 Hz
50.5 kHz-100 kHz	500 Hz
101 kHz-200 kHz	1 kHz
202 kHz-500 kHz	2 kHz
505 kHz-1 MHz	5 kHz

Compensation Frequencies

4276A: 100, 200, 500, 1k, 2k, 5k, 10k, 16k, 20 kHz

4277A: 10k, 20.2k, 50.5k, 100k, 202k, 505k, 700k, 900k, 1 MHz

Compensation at other frequencies is automatically done using second degree interpolation.

Offset Ranges

	4276A	4277A
OPEN	C ≤ 20 pF G ≤ 0.2 μS	C ≤ 20 pF G ≤ 2 μS
SHORT	Z ≤ 2 Ω	L ≤ 2 μH R ≤ 2 Ω

HP-IB Interface

Remote control: all front panel control settings and 16064A (Comparator) settings can be controlled using HP-IB.

Data output: parameter measured, equivalent circuit, display status, measured values and decision output of comparator.

Output format: ASCII and packed binary.

Self test: checks 4276A/4277A's basic operation.

Measurement accuracy and range: specified at the front panel unknown connectors when all of the following conditions are satisfied:

- (1) warmup time ≥ 30 min.
- (2) test signal level is set to HIGH (1 Vrms)
- (3) measurement speed mode: MED or SLOW
- (4) ambient temperature is 23°C ± 5°C
- (5) cable length switch is set to Om (4277A)
- (6) OPEN and SHORT adjustments have been made
- (7) $D \leq 0.1$ (L-D•Q, C-D•Q, and |Z| - θ measurements)
 $D \leq 0.002$ (4276A) high speed L/C measurement
 $D \leq 0.01$ (4277A)

Accuracies given in Tables 1 through 6 are read as ± (% of reading + number of counts) for L, C, and |Z|, and ± (number of degrees + number of counts) of θ.

C-D/C-Q (1/D) measurement accuracy: accuracies for C measurements are given in Table 1 (frequencies other than 100, 120, 1k, and 1 MHz) and Table 2 (100, 120, 1k and 1 MHz only). The 4277A's C accuracies in the tables are for the full scale value of each C range.

High Speed C Measurements can be made under the following conditions

	Test Frequency	Measurement Range	D
4276A	All frequencies	All ranges except for the two highest ranges at each frequency	≤ 0.002
4277A	1 MHz	1 pF - 10 nF	< 0.01

(Refer to the 4276A/4277A data sheet for complete accuracy specifications, including D/Q accuracies)

L-D/L-Q (1/D) Measurement: accuracies for L measurements are given in Table 3 (for frequencies other than 1k, 10k, 100k, and 1 MHz) and Table 4 (for 1k, 10k, 100k, and 1 MHz). The 4276A's L accuracies given in the tables are for the full scale value of each L range.

High Speed L Measurement can be made under the following conditions

	Test Frequency	Measurement Range	D
4276A	All frequencies	All ranges except for the two highest ranges at each frequency	≤ 0.002
4277A	1 MHz	1 μH - 100 μH	< 0.01

(Refer to the 4276A/4277A data sheet for complete accuracy specifications, including D/Q accuracies)

|Z| - θ Measurement: accuracies for |Z|/θ measurements are given in Table 5 (4276A) and Table 6 (4277A). Accuracies given in the tables are for the full scale value of each |Z| range.

DC Bias

Internal dc Bias (Opt.): 0 to ± 40 V

Bias Voltage	Voltage Step	Accuracy (at 23 ± 5°C)
-40.0 to -10.0 V	0.1 V	±(1% of reading + 35 mV)
-9.99 to -0.01 V	0.01 V	±(1% of reading + 10 mV)
0.00 to 9.99 V	0.01 V	±(0.3% of reading + 10 mV)
10.0 to 40.0 V	0.1 V	±(0.5% of reading + 35 mV)

Output resistance: 1020 Ω ± 10% (4276A)

1040 Ω ± 10% (4277A)

Control: front Panel or via HP-IB

External dc bias via rear panel: 0 to ± 40 V

Continuous Memory (approx. two weeks):

Memory contents: all front panel key settings, excluding BIAS, offset values, reference for deviation and comparator limit data.

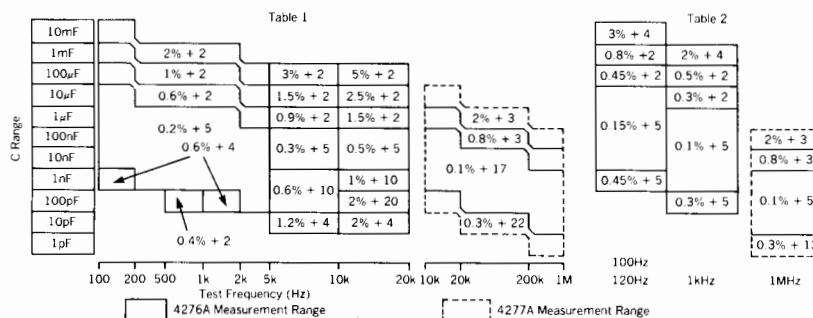

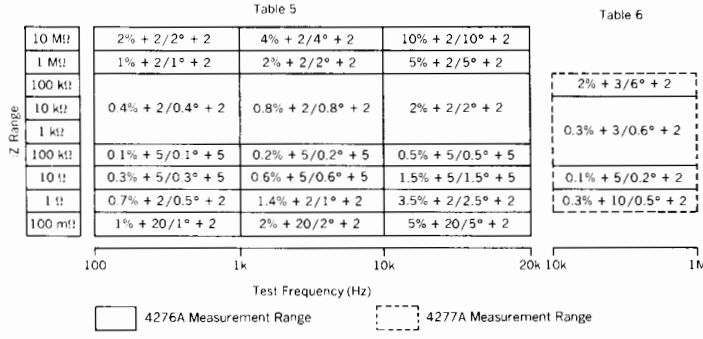
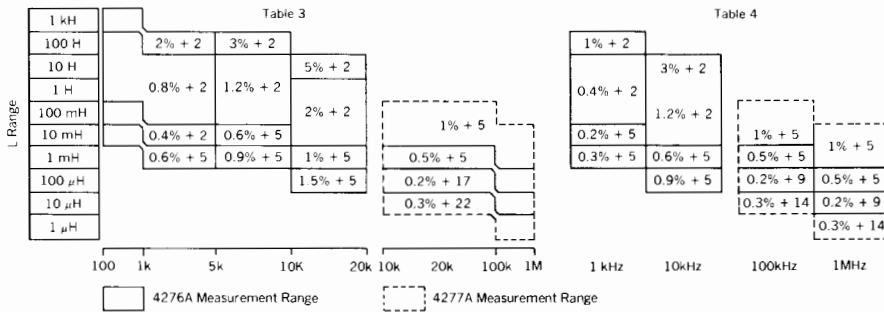

General

Measurement Time (typical)

4276A (circuit mode set to AUTO, and test signal level set to HIGH)

Capacitance measurement: applicable to all ranges except for highest range when measuring low loss capacitors of full scale value.

Inductance measurement: applicable to all ranges except for lowest range when measuring low loss inductors of full scale value.

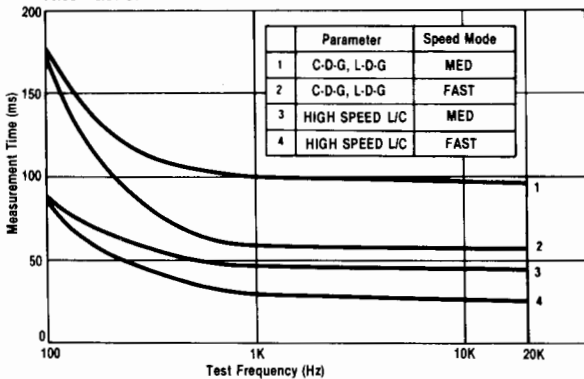

4277A (circuit mode set to AUTO)

Capacitance measurement: applicable to parallel C ranges when measuring low loss capacitors of full scale value.

Inductance measurement: applicable to series L ranges when measuring low loss inductors of full scale value.

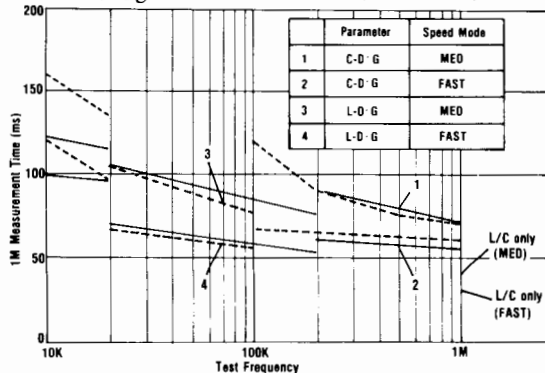

Operating temperature and humidity: 0° to 55°C, 40°C at 95% RH.

Power requirements: 100/120/220 VAC ± 10%, 240 V + 5% - 10%; 48 to 66 Hz.

Power consumption: 50 VA max (4276A); 65 VA max (4277A).

Size: 188 mm H x 426 mm W x 422 mm D (7 1/8" x 16 3/4" x 16 3/8").

Weight: approx. 8.5 kg (18.7 lbs.).

Options

Opt 001: Internal DC bias, 0 to ± 40 V, max resolution 10 mV/100 mV.

Opt 002: 10-bin sorting for L/C/Z and Go/No go testing for D/Q, interfaceable with component handler, useable only with 4276A/4277A.

limit data input: high and low limits using comparator numerical keys or HP-IB

limit setting range: 00000 to 19999

decision output: BIN number, LED (high/in/low), or HP-IB

Handler interface: (negative true):

Output signal: (open collector or TTL)

decision outputs: BIN number, high/in/low

index: analog measurement complete, photo isolated

measurement complete: full measurement complete, photo isolated

Input signal: (open collector or TTL)

external trigger: photo isolated

Accessories

Furnished accessories: 16047A Direct Coupled_Test Fixture

Accessories Available

16034B: Tweezer Type Test Fixture for Chip Components

16047C: Test Fixture

16048A: Test Leads, BNC (1m)

16048B: Test Leads, RF Miniature (1m)

16048C: Test Leads, with Alligator chips (1m)

16048D: Test Leads, BNC (2m)

16064A: Retrofit Kit for Comparator/Handler Interface (4276A/4277A, Opt 002)

16065A: External DC Bias Test Fixture (≤ 200 V)

Options

001: Internal DC Bias

002: Comparator

Ordering Information

4276A LCZ Meter

4277A LCZ Meter



COMPONENT & SEMICONDUCTOR MEASUREMENT

RF Impedance Analyzer

Model 4191A

- 1-1000 MHz variable test frequency with sweep capability
- Direct reading of $|Z| - \theta$, $|Y| - \theta$, $|\Gamma| - \theta$;
 $L \cdot C - R \cdot G \cdot D \cdot Q$
 $R - X, G - B, \Gamma_x - \Gamma_y$
- High resolution—4½ digit max
- Wide measuring range—1 m Ω – 100 k Ω ($|Z|$)
- Versatile easy-to-use test fixtures

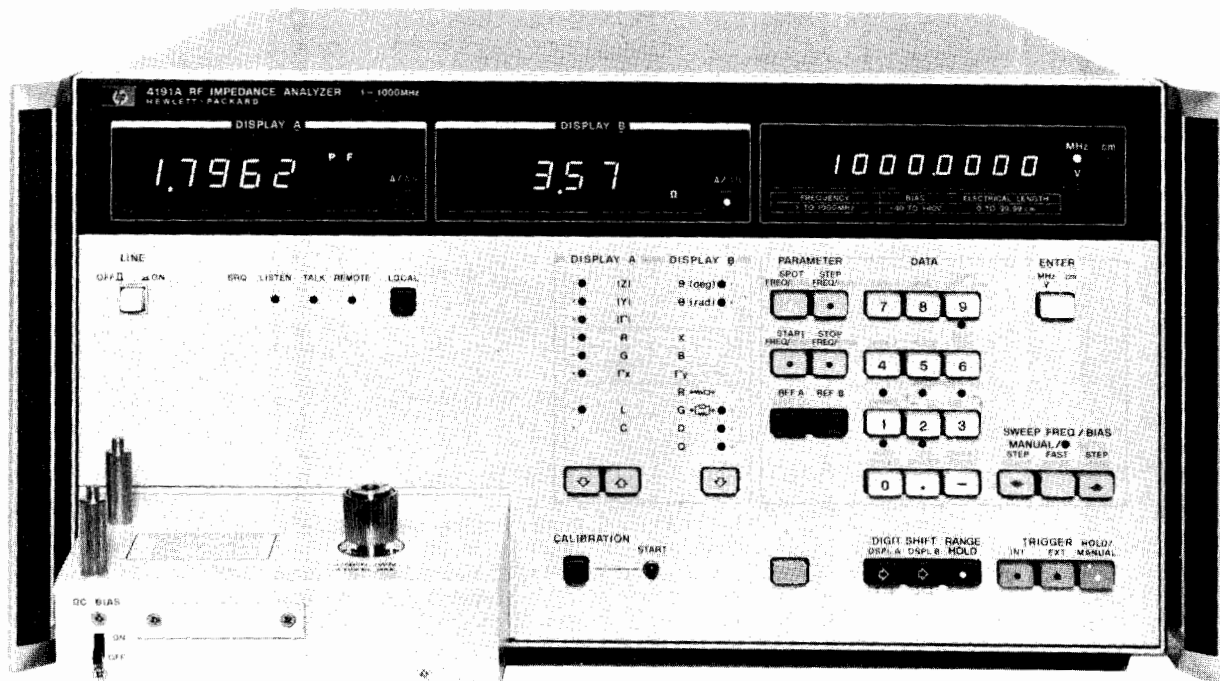

4191A (Shown with Opt 907 Handles)



Description

The HP Model 4191A RF Impedance Analyzer measures 14 parameters with a maximum resolution of 4½ digits. The internal synthesizer provides variable frequencies from 1 MHz through 1000 MHz covering the UHF, VHF and video bands with automatic sweep capability. An internal dc bias supply with auto sweep function covers the voltage range of ± 40 V in 10 mV steps.

The 4191A permits reliable measurements over a wide measuring range. Its outstanding repeatability, frequency response and accuracy are made possible by unique error correction capability and specially designed test fixtures. These features allow the 4191A to be used in evaluation of electronic materials, components and circuitry.

The internal synthesizer provides a maximum resolution of 100 Hz (Opt 002) with an accuracy of 3 ppm, allowing small changes in the resonant frequency of the device under test to be easily detected. The swept frequency capability aids in the analysis of frequency characteristics of the device.

Two complete front panel settings (parameter selection and the sweep control) can be stored in a non-volatile memory and recalled at any time with a single key operation. This, together with the standard HP-IB interface, makes the 4191A extremely efficient either as a stand-alone or systems instrument.

These unique features permit very wide applications in: (1) semiconductor testing such as surface state evaluation at high frequencies (C-V/G-V and conductance (G/ ω - ω) characteristics), and the input/output impedance evaluation of diodes and transistors, (2) resonator, filter, and magnetic and dielectric materials testing, (3) evaluation of LCR components such as high frequency chip and leaded components, and (4) testing of communications related components such as cables, connectors, etc.

Specifications

Parameter measured: $|Z| - \theta$, $|Y| - \theta$, $|\Gamma| - \theta$
 $R - X, G - B, \Gamma_x - \Gamma_y$
 $L - R \cdot G \cdot D \cdot Q, C - R \cdot G \cdot D \cdot Q$

Display: 4½ digit, max display 19999 counts

Deviation Measurement (deviation from stored reference)

Δ : -19999 to +19999 counts

$\Delta\%$: -1999.9 to +1999.9%

Measuring Signal ($23 \pm 5^\circ\text{C}$)

Frequency range: 1 MHz to 1000 MHz

Frequency step: Standard: 100 kHz, 1-500 MHz
 200 kHz, 500-1000 MHz

Opt 002: 100 Hz, 1-500 MHz

200 Hz, 500-1000 MHz

Frequency accuracy: ± 3 ppm

Signal level (into 50 Ω): -20 ± 3 dBm

Frequency control: spot and swept

Measuring Mode

Spot measurement: at specific frequency (or dc bias)

Swept measurement: manual or automatic sweep from start to stop frequency (or dc bias) at step frequency (or dc bias) rate in linear or logarithmic form.

Auto Calibration

Automatic error compensation referenced to connected terminations (0 Ω , 50 Ω , 0 S)

Calibration frequency: 51 frequencies between start and stop frequencies.

Electrical length compensation: automatic compensation for electrical length of test fixtures.

Compensating range: 0 to 99.99 cm.

DC Bias

Internal dc Bias

Voltage range: -40 to +40 V, 10 mV step
Setting accuracy: 0.1% of setting +10 mV
Bias control: spot and swept

External dc Bias

Voltage range: -40 to +40 V
Max allowable current: 100 mA

Key status memory: 2 sets of measuring conditions can be stored and recalled at any time. These conditions are kept in storage even when LINE is turned off.

Ranging: Auto/Range hold

Trigger: Internal, External or Manual

Self-test: automatic internal program test

HP-IB data output and remote control: standard

Measuring Range, Resolution and Accuracy

Specified at APC-7 UNKNOWN connector for reflect coefficient measurement at measuring frequency and ambient temperature (0 - 55°C) where calibration is performed after the warm-up time of 40 minutes. Refer to General Information for temperature coefficient and typical measuring range/resolution and accuracies of other measuring parameters (see data sheet for detailed specifications).

$|\Gamma| - \Theta/\Gamma x - \Gamma y$ Measurement

Measuring Range

$|\Gamma|, \Gamma x, \Gamma y:$ 0.0001 to 1.0000

$\Theta:$ 0° to ±180.00° (0 to ±π rad.)

$|\Gamma|, \Gamma x, \Gamma y$ resolution: 0.0001

$|\Gamma|, \Gamma x, \Gamma y$ accuracy (see graph below)

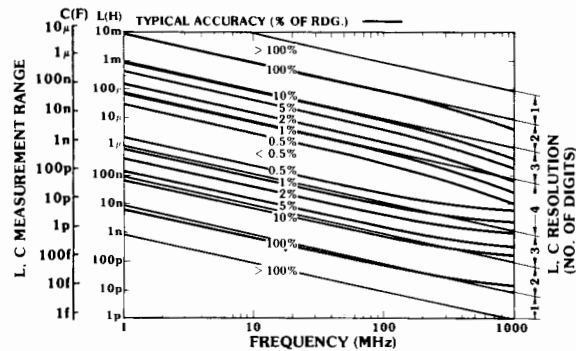
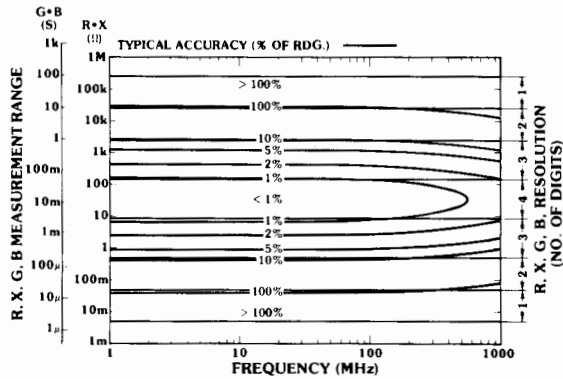
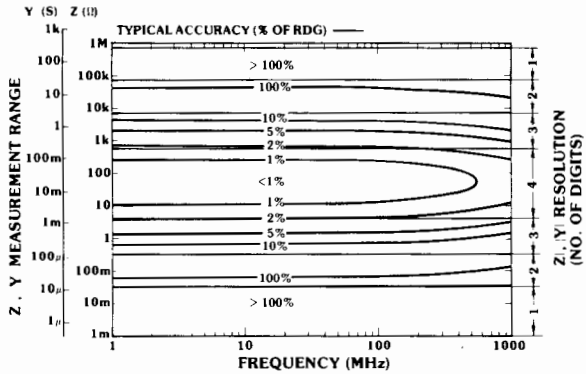
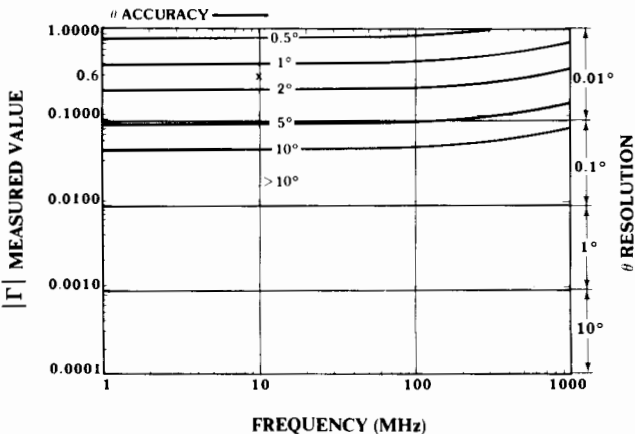
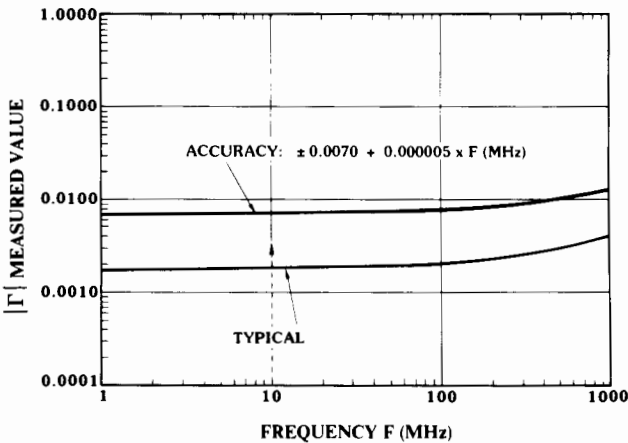

General

Temperature coefficient for $|\Gamma|, \Gamma x,$ and $\Gamma y:$ 0.0001/°C (23 ± 5°C)

Measuring time: <800 ms or <250 ms (high speed mode)

Frequency switching time: ≤ 200 ms

Temperature: 0 - 55°C, < 95% RH

Power: 100, 120, 220 V ± 10%, 240 V + 10% - 5%, 48 - 66 Hz, 150 VA max.

Size: 425.5 mm W x 230 H x 574 mm D (16.75" x 9" x 22.6").

Weight: Approx. 24 Kg. (52.8 lbs.)

Accessories furnished: accessory case (with reference terminations included).

Accessories Available

- 16091A Coaxial Fixture Set
- 16092A Spring Clip Fixture
- 16093A Binding Post Fixture
- 16093B Binding Post Fixture
- 16094A Probe Fixture

Options

- 002: 100 Hz/200 Hz resolution synthesizer
- 004: Recorder Outputs

4191A RF Impedance Analyzer

COMPONENT & SEMICONDUCTOR MEASUREMENT

LF Impedance Analyzer (5 Hz to 13 MHz)

Model 4192A

- 5 Hz to 13 MHz variable measuring frequency
- Gain-phase measurement: amplitude, phase and delay
- Floating or grounded devices
- Impedance measurement: $|Z| \cdot |Y| \cdot \theta \cdot R \cdot X \cdot G \cdot B \cdot L \cdot C \cdot D \cdot Q \cdot \Delta \cdot \Delta\%$
- Standard HP-IB

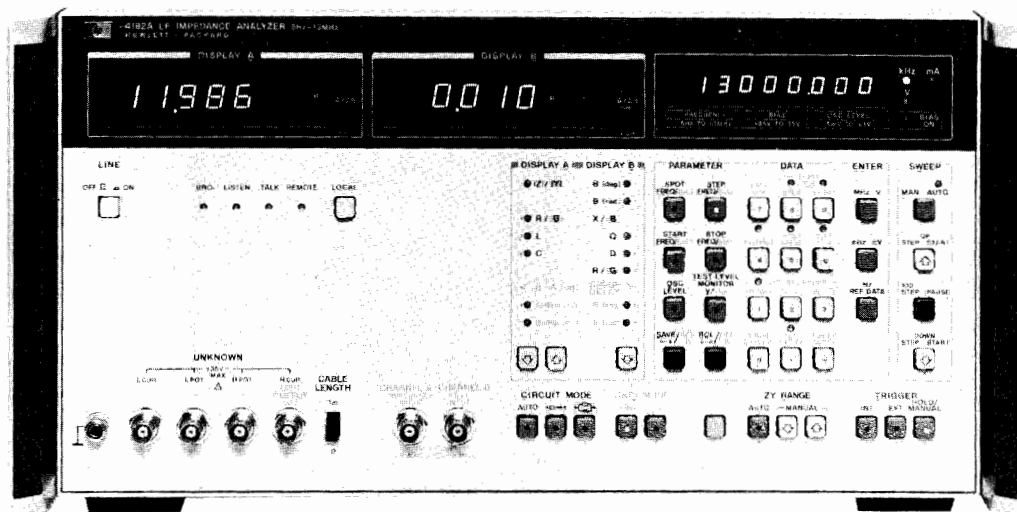

Description

The 4192A LF Impedance Analyzer performs both network analysis and impedance analysis on devices such as telecommunication filters, audio/video electronic circuits, and basic electronic components. Both floating and grounded devices can be tested.

Automatic Swept Frequency Measurement of All Impedance Parameters

The 4192A can measure 11 impedance parameters ($|Z|$, $|Y|$, θ , R, X, G, B, L, C, D, Q) over a wide range $|Z|$: 0.1 m Ω to 1 M Ω ; $|Y|$: 1 nS to 10 S).

The built-in frequency synthesizer can be set from 5 Hz to 13 MHz with a maximum resolution of 1 mHz. This feature allows accurate characterization of high Q devices such as crystals. Test signal level is variable from 5 mV to 1.1 V with 1 mV resolution. Also, an internal dc bias voltage source provides ± 35 V at 10 mV increments. Thus, the 4192A can evaluate components and entire circuits near actual operating conditions.

Specifications (complete specifications on data sheet)

Measuring signal (23 \pm 5 $^{\circ}$ C)

Frequency range: 5 Hz to 13 MHz

Frequency step: 0.001 Hz (5 Hz to 10 kHz), 0.01 Hz (10 kHz to 100 kHz), 0.1 Hz (100 kHz to 1 MHz), 1 Hz (1 MHz to 13 MHz).

Frequency accuracy: ± 50 ppm

OSC level: 5 mV to 1.1 Vrms variable into 50 Ω (amplitude-phase measurement) or open circuit (impedance measurement).

OSC level step: 1 mV (5 mV to 100 mV), 5 mV (100 mV to 1.1 V)

OSC level accuracy: 5 Hz to 1 MHz: $\pm(5 + 10/f)\%$ of setting ± 2 mV where f is in Hz. 1 MHz to 13 MHz: $\pm(4 + 1.5 \times F)\%$ of setting ± 2 mV where F is in MHz.

Level monitor (impedance measurement): current through or voltage across sample can be monitored

Control: spot and sweep via front panel or HP-IB

Measuring Mode

Spot measurement: at specific frequency (or dc bias)

Swept measurement: manual or automatic sweep from START to STOP frequency (or dc bias) at selected STEP frequency (or dc bias) rate

Sweep mode: linear or logarithmic (frequency only)

Recorder outputs: output dc voltage proportional to each measured value, and frequency or dc bias.

Maximum output voltage: ± 1 V

Output voltage accuracy: $\pm 0.5\%$ of voltage ± 20 mV

Key status memory: 5 sets of measuring conditions can be stored and recalled at any time.

HP-IB data output and remote control: standard

Self-test: automatic introspective testing

Trigger: internal, external or manual

Amplitude—Phase Measurement

Parameter measured: relative amplitude B-A (dB) and phase θ (degrees or radians), B-A and group delay, absolute amplitude A (dBm or dBV) or B (dBm or dBV), and deviation (Δ , $\Delta\%$) of all parameters

Reference amplitude: 0 dBV = 1 Vrms, 0 dBm = 1 mW (with 50 Ω termination)

OSC output resistance: 50 Ω

Channels A and B: input impedance: 1 M Ω $\pm 2\%$, shunt capacitance: 25 pF ± 5 pF

Display Range and Resolution

B-A: 0 to ± 100 dB*, 0.001 dB (0 to ± 20 dB), 0.01 dB (± 20 to ± 100 dB)

θ : 0 to $\pm 180^{\circ}$, 0.01 $^{\circ}$

Group delay: 0.1 ns to 19 s, max. resolution 4 $\frac{1}{2}$ digits

A or B: +0.8 to -100 dBV*, 0.001 dB (> -20 dB), 0.01 dB (< -20 dB), +13.8 to -87 dBm, 0.001 dB (> -20 dBm), 0.01 dB (< -20 dBm)

Measuring accuracy (23 \pm 5 $^{\circ}$ C): specified at BNC unknown terminals after 30 minute warmup (test speed: normal or average)

B-A (relative amplitude) and θ (phase) Measurement

Determined by sum of channel A and B accuracies given below (accuracy of each channel changes according to absolute input level)

*Accuracy of relative and absolute gain measurements is specified from 0 dB to ± 80 dB.

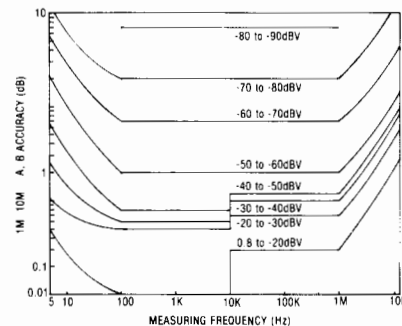

FIGURE 1: GAIN MEASUREMENT ACCURACY

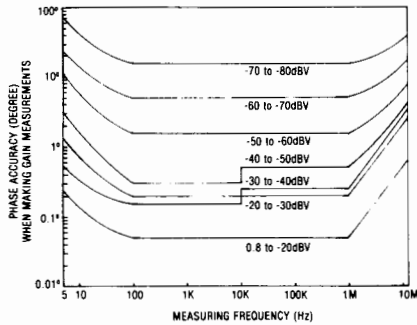

FIGURE 2: PHASE ACCURACY WHEN MAKING GAIN MEASUREMENTS

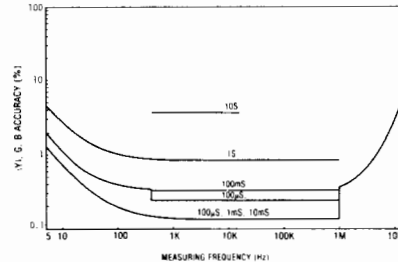

FIGURE 5: Y, G, B ACCURACY

Impedance Measurement

Parameter measured: $|Z| - \theta, |Y| - \theta, R - X, G - B, L - D \cdot Q \cdot R \cdot G, C - D \cdot Q \cdot R \cdot G$ and deviation ($\Delta, \Delta\%$) of all parameters

Display: 4½ digits, max. display 12999 counts

Circuit mode: series equivalent circuit (—□—) and parallel equivalent circuit (—□—). Automatic selection available.

Auto ZERO adjustment: automatic normalization of the readout offset due to residuals of the test fixture by pushbutton operation (at spot frequency)

Measuring range and accuracy ($23 \pm 5^\circ\text{C}$): specified at BNC unknown terminals after 30 minute warmup when OSC level is more than 0.3 V and when auto ZERO adjust is performed (test speed: normal or average). Accuracy given below is only valid when the measured value is equal to full scale of each range.

$|Z| - \theta, R - X$ measurement: range: $|Z|, R, X: 0.1 \text{ m}\Omega$ to 1.2999 M Ω ; $\theta: -180.00^\circ$ to $+180.00^\circ$. Accuracy: R accuracy ($D \geq 10$); X accuracy ($D \leq 0.1$)

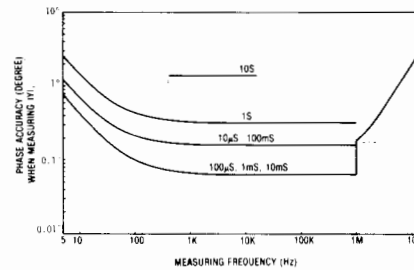

FIGURE 8: PHASE ACCURACY WHEN MEASURING Y

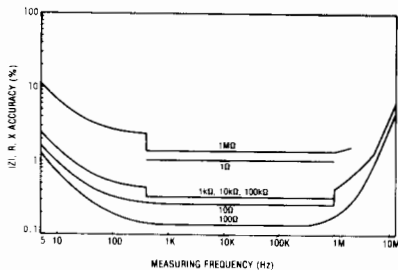

FIGURE 3: $|Z|, R, X$ ACCURACY

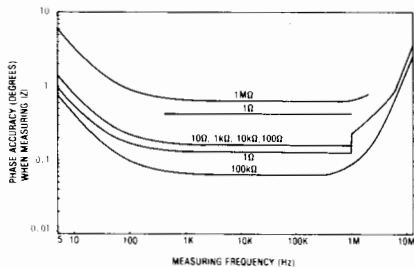

FIGURE 4: PHASE ACCURACY WHEN MEASURING Z

L - D · Q, C - D · Q measurement: (automatically calculated from measured Z/Y values)

Parameter	Measuring Range*	Basic Accuracy
L	0.01 nH to 1000 H	0.27%
C	0.1fF to 199** mF	0.15%
D(1/Q)	0.0001 to 19.999	0.001 (C-measurement) 0.003 (L-measurement)

*Varies with measuring frequency except for D(1/Q)

**Accuracy of C ranges over 100 mF is not specified.

Internal dc bias: standard (impedance measurement only)

Voltage range: -35 V to $+35 \text{ V}$, 10 mV step

Setting accuracy ($23 \pm 5^\circ\text{C}$): 0.5% of setting +5 mV

Bias control: spot and swept, using front panel controls or HP-IB

General

Measuring Time (high speed mode)

B-A and θ, A or B: 88 to 127 ms ($\geq 400 \text{ Hz}$)

Impedance parameters: 58 to 91 ms ($\geq 1 \text{ kHz}$)

Test Level Monitor Range (Impedance measurement)

Voltage: 5 mV to 1.1 V

Current: 1 μA to 11 mA

Operating temperature: 0 to 55°C , $\leq 95\% \text{ RH}$ at 40°C

Power: 100, 120, 220 V $\pm 10\%$, 240 V +5% to -10% , 48 to 66 Hz, 100 VA max.

Size: 425.5 mm W x 235 mm H x 615 mm D (16.75" x 9" x 22.6").

Weight: Approx. 19 kg (41.9 lbs.)

Furnished accessories and parts: 16047A test fixture, 50 Ω feed thru terminations (2 ea.), power splitter, BNC cables (2 ea.), BNC adapter

Accessories available

16095A Probe Fixture

16096A 2-port Component Test Fixture

16097A Accessory Kit

16047C 2-terminal Test Fixture

16048B Test Leads (miniature connector)

16048C Test Leads with alligator clip

4274A/4275A's test fixtures/leads are usable with 4192A

4192A LF Impedance Analyzer

$|Y| - \theta, G - B$ measurement: range: $|Y|, G, B: 1 \text{ nS}$ to 12.999 S; $\theta: -180.00^\circ$ to $+180.00^\circ$. Accuracy: G accuracy ($D \geq 10$); B accuracy ($D \leq 0.1$).

COMPONENT & SEMICONDUCTOR MEASUREMENT

Vector Impedance Meter (400 kHz to 110 MHz)

Model 4193A

- 400 kHz to 110 MHz spot or swept frequency
- Measure impedance magnitude (10 mΩ to 100.0 kΩ) and phase (-180.0° to +180.0°)
- Test components in-circuit and out-of-circuit
- Fixtures include low-grounded probe, spring clip fixture and binding post fixture
- Standard HP-IB and analog outputs

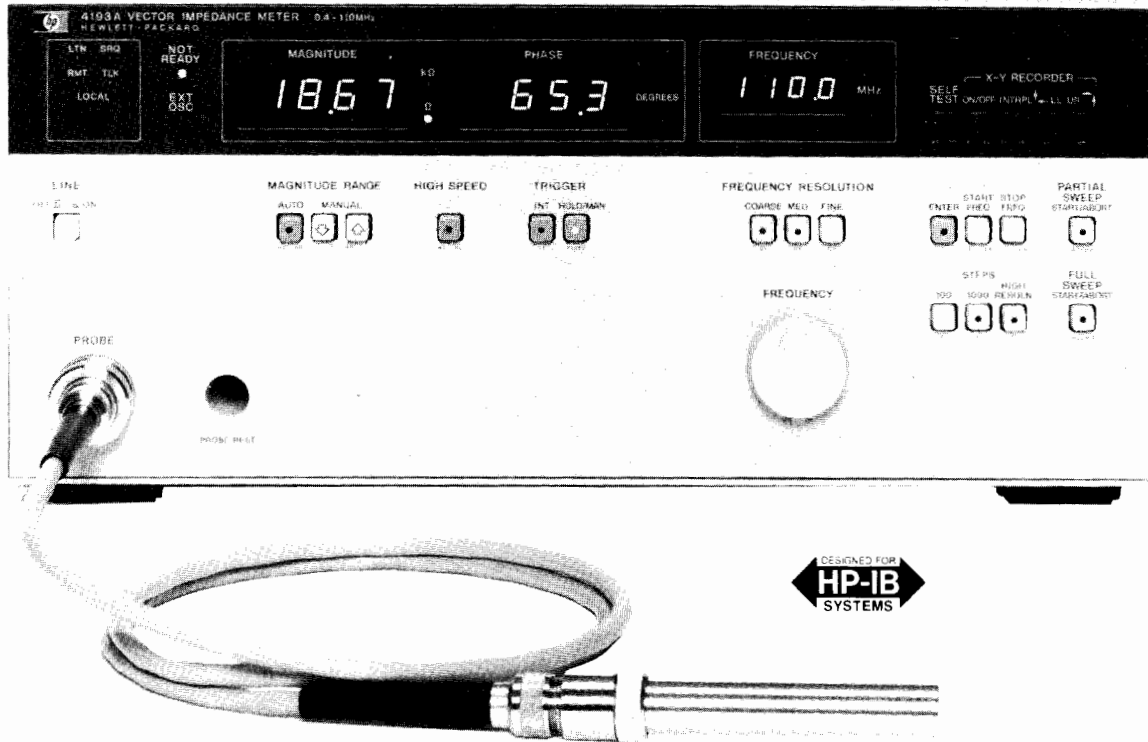

Description

The HP Model 4193A Vector Impedance Meter measures impedance magnitude and phase. An internal oscillator provides test signals from 400 kHz to 110.0 MHz. The test signal is constant current between 10 μA and 100 μA, depending on |Z| range.

Reliable and Accurate Impedance Measurement

The 4193A can measure and display impedance magnitudes from 10 mΩ to 100.0 kΩ. Impedance phase is displayed from +180.0° to -180.0°. Accuracy is as good as 3.0% of reading (magnitude) and 3.6° (phase).

Also, the 4193A's 3½ digit resolution makes it easy to see small changes in measurement results during adjustment procedures, for example.

Frequency Sweep for Complex Component Testing

When testing complex components like ceramic resonators, it is useful (1) to sweep frequency to get the big picture and (2) identify critical impedance points like series resonant point. This requires both swept measurement and measurements at individual "spot" frequencies. The 4193A can do both.

The 4193A can be tuned to any individual frequency from 400 kHz to 110.0 MHz with maximum resolution of 1 kHz. If greater frequency resolution is required, it can be provided by connecting an external synthesized source like the HP 3335A or 8656A to the 4193A EXT OSC input.

Flexible internal frequency sweep is an exciting 4193A feature. Frequency can be swept linearly over any portion of the 4193A frequency range—or swept logarithmically over the entire 400 kHz to 110.0 MHz range.

Test In-Circuit and Out-of-Circuit Components

Several test fixtures help adapt the 4193A to your device under test. For example, the handy L-ground probe is useful for in-circuit test-

ing. The 16099A Test Fixture Adapter and three associated fixtures help connect to out-of-circuit devices of various sizes and shapes.

Easy to Use—Both Manually and Under HP-IB Control

The 4193A front panel is amazingly simple. In just a few minutes you can become an expert operator. This is a big time saver over most other impedance meters which are usually much more difficult to operate. Plus, the 4193A has standard HP-IB, making it a good choice for automated testing in R&D, incoming inspection, production and product assurance.

Specifications

Test Signal Output Specifications

Test signal is output from the furnished low-ground probe.

Frequency range: 400 kHz to 110.0 MHz

Frequency Resolution

400 kHz to 9.999 MHz: 1 kHz resolution

10.00 MHz to 99.99 MHz: 10 kHz resolution

100.0 MHz to 110.0 MHz: 100 kHz resolution

Frequency accuracy: ±0.01% of setting after calibration.

Frequency stability: ±100 ppm per month (0 to 55°C)

Frequency Control

Spot: spot frequency is set using coarse, medium and fine controls

Full sweep: logarithmic sweep at 43 points over full range of 400 kHz to 110 MHz

Partial sweep: linear sweep from selected START to STOP frequency. Number of steps is selected as 100, 1000 or "HIGH RESOLN". When "HIGH RESOLN" steps is selected, the operator must also select "coarse", "medium" or "fine" resolution.



EXT OSC: increase frequency resolution by connecting an external frequency synthesizer like the HP 3335A or 8656A.

Input signal level: 0 dBm to +5 dBm

Input impedance: 50 ohms $\pm 10\%$

Frequency range: 400 kHz to 110 MHz

Test level: constant current source

Z Range	Current in $\mu\text{A} \pm 20\%$	Voltage ¹ Across DUT in μVrms
10 Ω	100	1
100 Ω	100	10
1 k Ω	100	100
10 k Ω	50	500
100 k Ω	10	1000

¹Voltage across DUT depends on |Z| of DUT. The voltage shown is across a |Z| of range value. For example, 1 Vrms would appear across |Z| of 10 Ω on the 10 Ω range.

Impedance Measurement Specifications

Input configuration: low-grounded probe (furnished)

Residual impedance of Probe (at probe tip)

Resistance: <0.55 Ω

Inductance: <(4.9 + 10/f) nH where f is measuring frequency in MHz

Capacitance: <0.11 pF

Digital display of impedance: 3½ digits

|Z|: 0 to 1999 counts (0 to 120 counts on 100 k Ω range)

θ : -1800 to +1800 counts (-180 to +180 counts on 100 k Ω range)

Measurement trigger: internal, external, and manual

Measurement range control: auto, hold, and manual

Measurement Range

|Z|: Five decade ranges: 10 Ω , 100 Ω , 1 k Ω , 10 k Ω , 100 k Ω

minimum |Z| (sensitivity): 10 m Ω

maximum |Z|: 100.0 k Ω

θ : One range: -180.0° to +180.0°

|Z| and θ Measurement Accuracy: in the Table below, "f" is in MHz

Range	Accuracy	Measuring Frequency in Megahertz		
		0.1	1	10
10 Ω Range	Z Accuracy	$\pm[(5.7 + 0.56/f)\% \text{rdg} + 9 \text{ counts}]$	$\pm(6.3\% \text{rdg} + 6 \text{ counts})$	$\pm[(4.5 + 0.18f)\% \text{rdg} + 4 \text{ counts}]$
	θ Accuracy	$\pm(1.7 + 1.8/f + \frac{35}{ Z \text{counts}}) \text{deg}$	$\pm(3.3 + 0.20f + \frac{35}{ Z \text{counts}}) \text{deg}$	
100 Ω Range	Z Accuracy	$\pm[(2.4 + 0.56/f)\% \text{rdg} + 4 \text{ counts}]$	$\pm(3.0\% \text{rdg} + 4 \text{ counts})$	$\pm[(2.6 + 0.037f)\% \text{rdg} + 4 \text{ counts}]$
	θ Accuracy	$\pm(1.5 + 1.9/f + \frac{35}{ Z \text{counts}}) \text{deg}$	$\pm(3.3 + 0.035f + \frac{35}{ Z \text{counts}}) \text{deg}$	
1 k Ω Range	Z Accuracy	$\pm[(3.2 + 0.56/f)\% \text{rdg} + 4 \text{ counts}]$	$\pm(3.7\% \text{rdg} + 4 \text{ counts})$	$\pm[(2.7 + 0.11f)\% \text{rdg} + 4 \text{ counts}]$
	θ Accuracy	$\pm(1.6 + 1.8/f + \frac{35}{ Z \text{counts}}) \text{deg}$	$\pm(3.3 + 0.11f + \frac{35}{ Z \text{counts}}) \text{deg}$	
10 k Ω Range	Z Accuracy	$\pm[(2.9 + 0.56/f)\% \text{rdg} + 4 \text{ counts}]$	$\pm[(3.2\% + 0.29f)\% \text{rdg} + 4 \text{ counts}]$	$\pm[(.74 + 53f)\% \text{rdg} + 4 \text{ counts}]$
	θ Accuracy	$\pm(2.1 + 1.9/f + \frac{35}{ Z \text{counts}}) \text{deg}$	$\pm(3.1 + 0.53f + \frac{35}{ Z \text{counts}}) \text{deg}$	$\pm(8.3 + .01f + \frac{35}{ Z \text{counts}}) \text{deg}$
100 k Ω Range	Z Accuracy	$\pm[(3.3 + 0.56/f)\% \text{rdg} + 4 \text{ counts}]$		
	θ Accuracy	$\pm(3.0 + 1.9/f + \frac{35}{ Z \text{counts}}) \text{deg}$		Not specified

Guideline for Use of the |Z| and θ Accuracy Table

- "f" is in MHz.
- "rdg" is display reading, for example, 50.0 ohms.
- "counts" is display counts in the |Z| display.
- "deg" is degrees of arc.

Example: calculate the |Z| and θ accuracy for a device which gives 4193A readings of |Z| = 50.0 Ω and θ = -45.0°. Assume an 0.9 MHz test frequency 100 Ω range, and normal measuring mode.

$$|Z| = 50.0 \Omega \pm [(2.4 + \frac{.56}{.9})\% \text{ of rdg} + 4 \text{ counts}]$$

$$|Z| = 50.0 \Omega \pm [(2.4 + \frac{.56}{.9}) * \frac{50.0 \Omega}{100\%} + .4 \Omega]$$

$$|Z| = 50.0 \Omega \pm 1.91 \Omega$$

$$\theta = -45.0^\circ \pm (1.5 + \frac{1.9}{.9} + \frac{35}{|Z|\text{counts}}) \text{deg}$$

$$\theta = -45.0^\circ \pm (1.5 + \frac{1.9}{.9} + \frac{35}{500}) \text{deg}$$

$$\theta = -45.0^\circ \pm 3.68^\circ$$

Recorder output: dc voltage proportional to measured |Z|, θ and measurement frequency.

Output voltage: accuracy specification for all recorder output voltages is $\pm(1\% + 20 \text{ mVdc})$

|Z|: 0 Vdc (0000 display counts) to +1 Vdc (1999 display counts)

θ : -1 Vdc (-180.0°) to +1 Vdc (+180.0°)

Frequency

Full sweep: 0 Vdc (400 kHz) to +1 Vdc (110 MHz), log sweep

Partial sweep: 0 Vdc (START frequency) to +1 Vdc (STOP frequency), linear sweep

HP-IB remote control and data output: standard

Self-test: standard

General Information

Test Signal Output

Frequency settling time: 5 ms to 300 ms. Best case is when ($\Delta f/f$)% is less than 10% (below 10 MHz) and less than 1% (above 10 MHz).

Signal Purity

Spurious: -60 dBc (dBc is dB below carrier)

Harmonics: -30 dBc

Residual FM: measured in a 100 Hz band centered on the carrier

400 kHz to 1 MHz: 40 Hz p-pFM

1 MHz to 110 MHz: 100 Hz p-pFM

Impedance Measurement

Measuring speed: assumes range is fixed; recorder output is OFF

HI SPEED: approximately 150 msec per measurement

NORMAL: approximately 1 s. per measurement

Ranging time: approximately 400 msec per range plus one measuring interval (e.g., 1 s. in normal mode)

Temperature coefficient at 23°C $\pm 5^\circ\text{C}$

|Z|: 2 m Ω /°C

θ : 0.02°/°C

Operating temperature/humidity: 0 to 55°C, 95% RH @ 40°C.

Note that measurement error in 0°C to 55°C temperature range is typically double the error in the 23°C $\pm 5^\circ\text{C}$ range.

Power: 100/120/220 V $\pm 10\%$, 240 V -10% to +5%, 48 to 66 Hz, Max 150 VA

Size: 426 mm W x 178 mm H x 498 mm D, (16.75" x 7" x 19.6").

Weight: 18 kg (40 lbs.)

Accessories furnished: low-ground probe kit includes probe, spare pins, spare clips, BNC adapter, component mounting adapter, probe socket and accessory case.

Accessories Available

16099A Test Fixture Adapter: (used with 16092A, and 16093A/B)

16092A Spring Clip Fixture: (used with 16099A)

16093A Binding Post Fixture: (used with 16099A)

16093B Binding Post Fixture: (used with 16099A)

4193A Vector Impedance Meter

COMPONENT & SEMICONDUCTOR MEASUREMENT

Digital LCR Meters

Models 4261A and 4262A

- Automatic balancing, ranging & circuit mode selection
- Test frequencies: 4261A... 120 (100) Hz and 1 kHz
4262A... 120 (100) Hz, 1 kHz and 10 kHz
- Versatile accessories and options
- High reliability

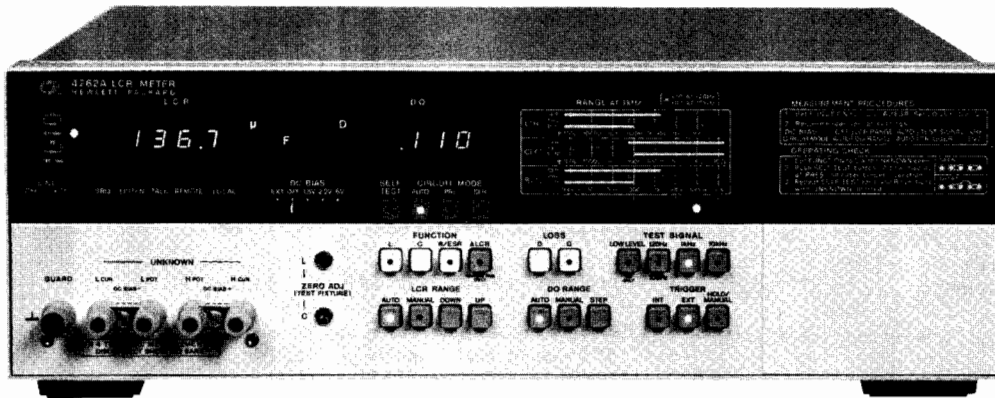

4262A



4261A

Description

The HP 4261A and 4262A are 3½ digital LCR meters that meet today's requirements for component measurements. Both instruments feature fully automatic operation over wide measuring range. Simply select the measuring functions and one of the test frequencies, and then insert the device to be measured. The instrument does the rest—automatically selecting the proper measuring range and equivalent circuit mode. The HP 4261A and 4262A basic features are summarized in the table below.

	4261A	4262A
Test Frequency	120 (100) Hz, 1 kHz	120 (100) Hz, 1 kHz, 10 kHz
Signal Level	1 V, 50 mV (Cp)	1 V, 50 mV (Cp)
Parameters Measured	C-D L-D R	C-D • Q L-D • Q R (ESR) Δ (Deviation)
HP-IB	NO	YES (OPT.)
Digital Comparison	NO	YES (OPT.)
BCD Output	YES (OPT.)	YES (OPT.)

In addition to automatic measurements, the 4261A and 4262A provide high accuracy (0.2% reading), internal dc bias, and series and parallel equivalent circuit modes.

These relatively low cost and easy to use LCR meters are capable of a wide range of applications—measuring electrolytic/ceramic capacitors, filter coils, pulse transformers, internal resistance of dry cells and semiconductor junction capacitance, as well as ordinary LCR components. Extended features of these reliable instruments include optionally available HP-IB and BCD data output capabilities and a comparison option which is convenient for production line applications.

Specifications (refer to data sheet for complete specifications) Measurement ranges and accuracies: See table on next page. Accuracy applies over a temperature range of 23°C ± 5°C (at 0° to 55°C, error doubles). 10 kHz and Q specifications are given only for the 4262A.

	4261A	4262A
Parameters measured	L-D, C-D R	L-D • Q, C-D • Q R (ESR), Δ LCR
Display	3 • ½ digits max. display 1900	3 • ½ digits max. display 1999
Test frequency	120 (100) Hz, 1 kHz ± 3%	120 (100) Hz, 1 kHz 10 kHz ± 3%
Test signal level (typical)	1 V, 50 mV (Cp mode only)	
DC bias	INT	1.5 V, 2.2 V, 6 V ± 5%, selectable
	EXT	0 to +30 V
Equivalent circuit modes	auto, parallel, series	
Ranging modes	LCR	auto, manual
	DQ	—
Trigger	internal, external, manual	
Measuring terminal	5-terminal configuration	

Deviation measurement (4262A): displays the difference between a stored value (that is, measured value when Δ LCR switch is depressed) and subsequent measured data.

Offset adjustments (4262A): front panel adjustments to compensate for stray capacitance and residual inductance of the test fixture.
C: 0 to 10 pF L: 0 to 1 μH

Self-test (4262A): automatically checks the 4262A's basic functions.

General

Measuring time (typical): for a 1000 count measurement on a low loss component on a fixed range:

1 kHz, 10 kHz: C/L 220-260 ms, R 120-160 ms

120 (100) Hz: C/L 900 ms, R 700 ms

Ranging Time

1 kHz, 10 kHz: 180 ms/range step

120 (100) Hz: 670 ms/range step

Reading rate: INT (internal trigger) approximately 30 ms between end of measurement cycle and start of the next cycle. EXT (External trigger) measuring cycle is initiated by a remote trigger input.

C-D/C-Q Measurement

Range	C	120 (100) Hz 1 kHz 10 kHz	1000 pF 100.0 pF 10.00 pF	10.00 nF 1000 pF 100.0 pF	100.0 nF 10.00 nF 1000 pF	1000 nF 100.0 nF 10.00 nF	10.00 μF 100.0 μF 1000 nF	100.0 μF 10.00 μF 1000 nF	1000 μF 100.0 μF 10.00 μF	10.00 mF 1000 μF 100.0 μF	
	D	0.001 to 1.900 (4261A), 0.001 to 19.9 (4262A)									
	Q* ¹	0.050 to 1000 (4 ranges, 4262A)									
C Accuracy * ₂		0.2% + 1* ³									
		At 120 (100) Hz, 1 kHz			0.3% + 2			0.5% + 2		1% + 2**	
		At 10 kHz						1% + 2		5% + 2	
D (1/Q) Accuracy **		0.2% + (2 + 200/Cx)						At 120 (100) Hz, 1 kHz			
		0.5% + (2 + 200/Cx)						At 10 kHz			
		At 120 (100) Hz, 1 kHz			0.3% + (2 + Cx/500)			1% + (5 + Cx/500)			
		At 10 kHz			0.5% + (2 + Cx/500)			1% + (5 + Cx/500)		5% + (5 + Cx/500)	

*¹Calculated as the reciprocal of D.
²± (% of reading + number of counts), Cx is capacitance readout in counts. Accuracies in this table apply when D < 1.900.
³Add 0.2 pF for 4261A.
⁴(5% + 2 counts) at 1 kHz.

L-D/L-Q Measurement

Range	L	120 (100) Hz 1 kHz 10 kHz	1000 μF 100.0 μH 10.00 μH	10.00 mH 1000 μH 100.0 μH	100.0 mH 10.00 mH 1000 μH	1000 mH 100.0 mH 10.00 mH	10.00 H 1000 mH 100.0 mH	100.0 H 10.00 H 1000 mH	1000 H 100.0 H 10.00 H	
	D	0.001 to 1.900 (4261A), 0.001 to 19.9 (4262A)								
	Q* ¹	0.050 to 1000 (4 ranges, 4262A)								
L Accuracy * ₂		At 120 (100) Hz, 1 kHz			0.3% + 2			1% + 2		
		At 10 kHz						5% + 2		
		0.2% + 2* ³						At 120 (100) Hz, 1 kHz		
		0.3% + 2		0.2% + 2		At 10 kHz				
D (1/Q) Accuracy * ₂		At 120 (100) Hz, 1 kHz			0.3% + (3 + Lx/500)			1% + (3 + Lx/500)		
		At 10 kHz			0.5% + (3 + Lx/500)			1% + (3 + Lx/500)		5% + (5 + Lx/500)
		0.2% + (3 + 200/Lx)						At 120 (100) Hz, 1 kHz		
		0.5% + (3 + 200/Lx)						At 10 kHz		

*¹Calculated as the reciprocal of D.
²± (% of reading + number of counts), Lx is inductance readout in counts. Accuracies in this table apply when test signal level is 1 V and D < 1.900.
³Add 0.2 μH for 4261A.

R (ESR)*¹ Measurement

Range	120 (100) Hz 1 kHz 10 kHz	1000 mΩ	10.00 Ω	100.0 Ω	1000 Ω	10.00 kΩ	100.0 kΩ	1000 kΩ	10.00 MΩ	
Accuracy * ₂		0.3% + 2* ³								
		0.2% + 1								

*¹ESR measuring range is from 1 mΩ to 19 kΩ (typical). These values vary depending on the series capacitance or inductance value of the device under test.
²± (% of reading + number of counts).
³± (5% + 2 counts) on 10.00 MΩ range at 10 kHz.

	4261A	4262A
Operating Temperature and humidity	0°C to 55°C 95% RH at 40°C	
Power requirements	100/120/220/240 V ± 10% 48-66 Hz	100/120/220 V ± 10%, 240 V + 5% -10%, 48-66 Hz
Power Consumption	≤25 VA	≤55 VA
Size	132.6 H x 213 W x 427 mm D (5 * 1/4" x 8 * 3/8" x 16 * 5/8")	147 H x 426 W x 345 mm D (5 * 3/4" x 16 * 3/4" x 13 * 3/4")
Weight (approx.)	7.5 kg (16.51 lbs)	8 kg (17.51 lbs)

Accessories available: **16061A:** test fixture, direct couple, 5-terminal; **16062A:** test leads with alligator clips, 4-terminal (for low impedance measurements); **16063A:** test leads with alligator clips, 3-terminal (for high impedance measurements).

Ordering Information (4261A)

- 16061A Test Fixture
- 16062A Test Leads
- 16063A Test Leads
- Opt 001: BCD Output (Simultaneous)
- Opt 002: BCD Output (Alternately)
- Opt 003: BCD Remote Control
- Opt 910: Extra Manual
- 4261A Digital LCR Meter

Options Available

Option	4261A* ¹	4262A* ²
001	BCD data output (L/C/R and D simultaneously)	BCD data output
002	BCD data output (L/D, C/D, R alternately)	—
003	BCD remote control	—
004	—	Digital comparator
101	—	HP-IB

*¹Options 001 and 002 are mutually exclusive.
²Option combinations 101/001 and 101/004 cannot be ordered.

Ordering Information (4262A)

- Opt 001: BCD Output
- Opt 004: Digital Comparator
- Opt 010: 100 Hz Test Frequency
- Opt 101: HP-IB Interface
- Opt 908: Rack Flange Kit
- Opt 910: Extra Manual
- 16061A Test Fixture
- 16062A Test Cables
- 16063A Test Cables
- 4262A Digital LCR Meter

COMPONENT & SEMICONDUCTOR MEASUREMENT

1 MHz C Meter/C-V Plotter

Model 4280A

- Built-in sweepable dc bias source and timer for C-V (Capacitance-Voltage)/C-t (Capacitance-Time) measurements
- High speed C-t measurements with minimum measurement interval of 10 ms (10 μ s if an external pulse generator is used)
- Basic C/G measurement accuracy: 0.1%
- Test lead extension up to 5 m
- 5½-digit display resolution (option) for C measurement

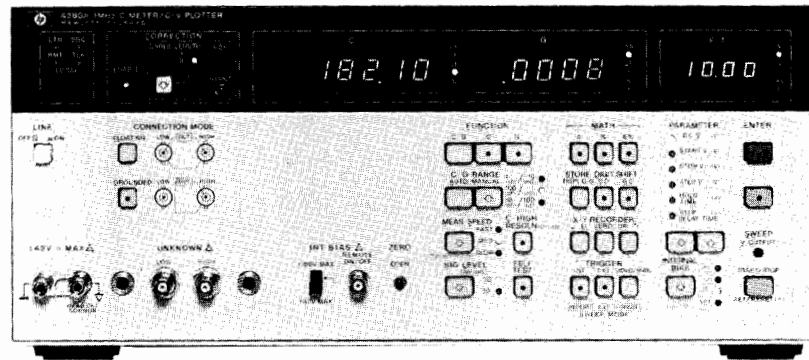

Description

HP's Model 4280A 1 MHz C Meter/C-V Plotter measures the capacitance and conductance of semiconductor devices and materials as functions of applied voltage (C-V) or time (C-t). The 4280A consists of 1) a precision 1 MHz C-G meter, 2) a programmable dc bias source that can be swept in staircase fashion, and 3) accurate timing control.

C-V and C-t Measurements

The 4280's internal dc bias source has a range of 0 V to ± 100 V with 1 mV resolution on the most sensitive range. Various measurement parameters for C-V and C-t measurements—hold time (bias pulse width) and step delay time (measurement interval)—can be manually set from the front panel. Or these parameters can be set under program control via the HP-IB. Settable range for C-t measurement interval is 10 ms to 32s with a best case resolution of 10 μ s. If an external pulse generator is used, however, measurement intervals as short as 10 μ s can be set. Up to 9999 readings can be set for a C-t measurement. These capabilities make it possible for the 4280A to measure the C-t characteristics of virtually any device.

High Speed C-t Measurement

A special sampling integration technique employed in the 4280A provides measurement intervals as short as 10 μ s using an external pulse generator, such as the HP 8112A or 8160A, to provide the bias pulse. Short measurement interval makes the 4280A applicable to Deep Level Transient Spectroscopy (DLTS) measurements, which are commonly used to analyze the physical characteristics of semiconductors.

Precision, High Resolution Measurements

The 4280A measures capacitances up to 1.900 nF, over three ranges, with 0.001 pF resolution on the most sensitive range. Conductance up to 12 mS can be measured with a maximum resolution of 10 μ s.

C and G measurements are made at 1 MHz. AC signal level is selectable between 10 mVrms or 30 mVrms, suitable for semiconductor measurements. Basic measurement accuracy is 0.1%. Maximum display resolution is 4½ digits. With Option 001, however, display resolution for capacitance is 5½ digits.

The accuracy and resolution of the 4280A satisfy the stringent requirements of laboratory and R and D measurements, which require the detection of minute changes in device characteristics.

Probed Measurements On Wafers

HP's 4280A has an automatic error correction function that makes

it possible to use test leads up to 5 m long. And the 4280A can measure either floating or grounded devices. Thus, the 4280A can be connected to a wafer prober and still provide stable, accurate C and G measurements.

Easy, Low Cost Systemization

HP-IB is standard on the 4280A. So, a process evaluation system or a lab automation system capable of evaluating the physical characteristics of semiconductor devices can be easily constructed.

The 4280A is equipped with analog outputs to allow users to plot device characteristics on an X-Y recorder or large screen display.

Specifications (refer to data sheet to complete specifications)

Measurement functions: C, C-V and C-t

Function		Available Internal dc Bias Function
Basic Function	Selection	
C	C only C-G only	OFF, --- (DC)
C-V	C-V G-V C & G-V	
C-t	C-t G-t C & G-t	

C Measurement

Test Signal

Frequency: 1 MHz $\pm 0.01\%$

OSC level: 30 mVrms or 10 mVrms $\pm 10\%$

Measurement terminals: two-terminal-pair configuration (High, Low and Guard).

Connection mode: sets connection configuration between DUT (floating/grounded) and measurement circuit.

Ranging: auto or manual

Error Compensation

Cable length: 0 m, 1 m or 0-5 m. The standard cable (P/N 8120-4195) up to 5 m can be internally compensated.

Zero open: compensate stray capacitance and conductance at the test fixture.

External error compensation: compensate errors by external computer to eliminate other error factors not listed above.

Measurement speed: FAST, MED or SLOW

Trigger: Internal, External or Hold/Manual

Internal dc bias mode: OFF or --- (DC)



Measurement Range/Resolution/Accuracy

Range ¹	Resolution ²	Max. Display ³	Accuracy ⁴ ± (% of rdg + counts)	
			OSC: 30 mV	OSC: 10 mV
10 pF/100 μS	0.001 pF 0.01 μS	19,000 pF 120,00 μS	±(0.1% + 5) ±(0.2% + 5)	±(0.2% + 5) ±(0.3% + 5)
100 pF/1 mS	0.01 pF 0.1 μS	190,00 pF 1,2000 mS	±(0.1% + 3) ±(0.2% + 3)	±(0.2% + 3) ±(0.3% + 3)
1 nF/10 mS ⁵	0.1 pF 0.001 mS	1,9000 nF 12,000 mS	±(0.1% + 3) ±(1.2% + 3)	±(0.2% + 3) ±(1.2% + 3)

¹ 100 pF/1 mS and 1 nF/10 mS ranges only in grounded measurement.

² When measurement speed is set to FAST (10 mV/30 mV) or MED (10 mV), resolution and Max. display become 1 digit lower (3% digit display).

³ Approx. 50 pF at 100 pF/1 mS range and 1.78 nF at 1 nF/10 mS range in grounded measurement. Error correction to offset residuals will reduce maximum value which can be measured.

⁴ Accuracy is specified at UNKNOWN terminals and at the end of 16082A Test Leads (1 m) after warm-up ≥ 30 min., at temperature 23°C ± 5°C, zero open calibration is performed, and CORRECTION is enabled. Front panel settings are C-G, FLOATING and 0 m or 1 m (CABLE LENGTH). Some errors will be added at other settings (refer to data sheet). C accuracy is specified when D < 0.05 and G accuracy is specified when counts of C < 1/100 of range. Error double at 0°C-55°C.

⁵ Add 0.1% of rdg for C and 0.2% of rdg for G when 16082A is used.

C-V Measurement

Function: measures C-V, G-V or C & G-V characteristics using internal staircase bias.

Measurement speed: FAST, MED or SLOW

C-t Measurement

Function: measures C-t, G-t or C & G-t characteristics using internal and/or external pulse bias source.

Internal measurement mode: Burst or Sampling Mode automatically selected.

Burst mode: apply one pulse then make repetitive measurement with specified time interval between measurements.

Sampling mode: repeated pulse with single samples between pulses. Delay between application of measure voltage and sample can be specified.

Measurement speed: FAST or MED

DC Bias Source

Output Mode: , , , (DC) or OFF

Output Voltage Range/Resolution/Accuracy

Voltage Range	Resolution	Accuracy [*] ± (% of setting + volts)
±1.999 V	1 mV	±(0.2% + 0.01 V)
±19.99 V	10 mV	±(0.1% + 0.02 V)
±100.0 V	100 mV	±(0.1% + 0.1 V)

^{*} at 23°C ± 5°C, at 0°C -55°C error doubles

Staircase Sweep Parameter Settings (C-V Basic Function Only)

Start/stop voltage: 0 V - ± 100 V (max. 1 mV resolution)

Step voltage: 0 V - 200 V (max. 1 mV resolution)

Hold/step delay time (th/td): 3 ms - 650s (max. 1 ms resolution)

Pulse Bias Parameter Settings (C-t basic function only)

DC/pulse/measurement voltage: 0 V - ± 100 V (max. 1 mV resolution)

Number of readings: 1-9999

Hold time (th): max. 10 μs resolution

Internal bias: 10 ms - 32 s

Ext bias slow: 50 μs - 32 s

Ext bias fast: 10 μs - 32 s

Delay time (td): 10 μs - 32 s (max. 10 μs resolution)

Burst Mode

Function	Meas. Speed	Block Mode	Non Block Mode	
			Data Format	
			Binary	ASCII
C-t	FAST	10 ms-32 s	20 ms-32 s	150 ms-32 s
G-t	MED	50 ms-32 s	200 ms-32 s	200 ms-32 s
C & G-t	FAST			
	MED	100 ms-32 s	250 ms-32 s	

Sampling Mode

EXT BIAS SLOW: 200 μs - 5 s

EXT BIAS FAST: 10 μs - 5 s

Math functions: displays measured C/G values as differential values (Δ), % ratio (%) or differential % (Δ%) of the reference value.

Other

HP-IB: not just IEEE-488, but the hardware, documentation and support that delivers the shortest path to a measurement system.

Data output format: ASCII or Binary

Block mode output: can make C-V/t characteristics measurement and store measured data (C-V/t or G-V/t Function: 680 data, C & G-V/t Function: 400 data) into the internal data buffer. Then, packed data can be output.

Recorder Output

Output voltage: ± 10 V for C, G and V/t data

Accuracy: ± (% of output voltage + V)

C or G: ± (0.5% + 20 mV)

V or t: ± (0.15% + 40 mV)

Selftest: verifies normal measurement operations (not including calibration)

Options

Option 001: High Resolution Offset Capacitance Measurement

Function: increase C measurement resolutions by one digit with offset reference value.

C offset range: 0 pF - 1023 pF (1 pF increment). C offset value can be set by measured data or numeric key.

General Specifications

Operating temperature range: 0°C to 55°C; 95% RH at 40°C

Power requirements: 100/120/220 V ± 10%, 240 V + 5% - 10%; 48 to 66 Hz; 140 V A max.

Dimensions: 426 mm W x 177 mm H x 498 mm D (16.5" x 7" x 19.5")

Weight: 15.3 kg (33.7 lbs)

Accessories Furnished

16080A: Direct coupled test fixture

Accessories Available

16081A: test leads, doubled shielded (2 m)

16082A: test leads, shielded (1 m)

16083A: Noise Clipper for pulse bias from the pulse generator

Reference Data (reference data are typical values given for information purpose)

C/G measurement time: A (+B) (+C) (+D)

	Meas. Speed	Display Parameter		
		C	G	C-G
A (Net Meas. Time)	FAST	10 ms		30 ms
	MED	40 ms	35 ms	70 ms
	SLOW	270 ms	220 ms	400 ms
B (Internal Error Compensation Time)		30 ms		60 ms
C (MATH Function Time)		10 ms		20 ms
D (Display Output Time)		10 ms		20 ms

Residual L-R compensation: error compensation for residual L-R (Max. 19 μH/190 Ω) is available using an external controller.

Internal dc Characteristics of High and Low Unknown Terminals (without dc bias)

Maximum offset voltage: ± 1 mV

Maximum allowable current: 100 mA

Internal dc Bias

Settling time (99.9% of final value): 0.05 × voltage swing (V) + 1.7 (ms)

Maximum output current: ± 6 mA

Hold time/step delay time/th/td: 0.02% (basic accuracy)

Response time of the EXT SLOW bias circuit (99.9% of final value): 100 μs

Option 001

C offset accuracy: ± (0.2% of reference value + 0.5 pF) can be compensated by CORRECTION ENABLE key.

Ordering Information

Opt 001 C-High Resolution (field installation is not possible)

16081A Test Leads, 2 m double shielded, BNC

16082A Test Leads, 1 m, BNC

4280A 1 MHz C Meter/C-V Plotter



COMPONENT & SEMICONDUCTOR MEASUREMENT

Q Meter

Model 4342A

- Frequency range: 22 kHz to 70 MHz
- Q range: 5 to 1000

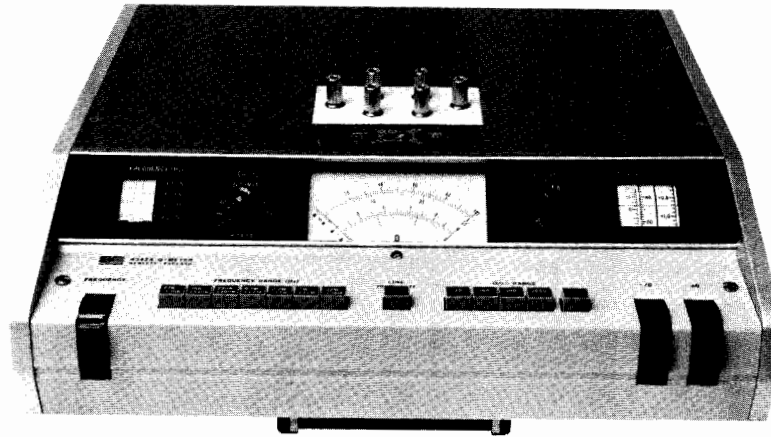

Description

The direct-reading expanded scale of the 4342A permits measurement of Q from 5 to 1000 and readings of very small changes in Q resulting from variation in test parameters. The 4342A is solid state with the elimination of specially matched, fragile thermocouple components.

The 4342A will measure dissipation factor and dielectric constant of insulating materials. The Q meter can measure coefficient of coupling, mutual inductance, and frequency response of transformers. RF resistance, reactance, and Q of resistors and capacitors can also be determined.

Push button operation of frequency range and Q/ Δ Q range selection provides straightforward measurement. Automatic indication of meter scales, frequency dials and frequency multipliers are featured, adding to simplicity and reading speed.

Specifications

RF Characteristics

RF range: 22 kHz to 70 MHz in 7 bands: 22 to 70 kHz, 70 to 220 kHz, 220 to 700 kHz, 700 to 2200 kHz, 2.2 to 7 MHz, 7 to 22 MHz, 22 to 70 MHz.

4342A Opt 001: 10 kHz to 32 MHz in 7 bands: 10 to 32 kHz, 32 to 100 kHz, 100 to 320 kHz, 320 to 1000 kHz, 1 to 3.2 MHz, 3.2 to 10 MHz, 10 to 32 MHz.

RF accuracy: $\pm 1.5\%$ from 22 kHz to 22 MHz; $\pm 2\%$ from 22 MHz to 70 MHz; $\pm 1\%$ at "L" point on frequency dial.

4342A Opt 001: $\pm 1.5\%$ from 10 kHz to 10 MHz; $\pm 2\%$ from 10 MHz to 32 MHz; $\pm 1\%$ at "L" point on frequency dial.

RF increments: approximately 1% resolution.

Q Measurement Characteristics

Q range: 5 to 1000 in 4 ranges: 5 to 30, 20 to 100, 50 to 300, 200 to 1000.

Q accuracy: % of indicated value: (at 25°C)

	4342A & 4342A Opt. 001	4342A
Q Freq.	22 kHz-30MHz	30 MHz-70 MHz
5-300	± 7	± 10
300-600	± 10	± 15
600-1000	± 15	± 20

Q increments: upper scale: 1 from 20 to 100; lower scale: 0.5 from 5 to 30.

Δ Q range: 0 to 100 in 4 ranges: 0 to 3, 0 to 10, 0 to 30, 0 to 100.

Δ Q accuracy: $\pm 10\%$ of full scale.

Δ Q increments: upper scale: 0.1 from 0 to 10; lower scale: 0.05 from 0 to 3.

Inductance Measurement Characteristics

L range: 0.09 μ H to 1.2 H, direct reading at 7 specific frequencies.

L accuracy: $\pm 3\%$ after substitution of residuals (approx. 10 nH).

Resonating Capacitor Characteristics

Capacitor range: main dial: 25 to 470 pF; vernier dial -5 to $+5$ pF.
Capacitor accuracy: main dial: $\pm 1\%$ or 1 pF, whichever is greater; vernier dial ± 0.1 pF.

Capacitor increments: main dial: 1 pF from 25 to 30 pF; 2 pF from 30 to 200 pF; 5 pF from 200 to 470 pF; vernier dial: 0.1 pF.

General

Rear Panel Outputs

Frequency monitor: 170 mV rms min. into 50 Ω .

Q analog output: 0 to 1 V ± 50 mV dc after 15 minutes warmup, proportional to meter deflection. Output impedance approximately 1 k Ω .

Over limit signal output: contact closure at the rear panel. Relay contact capacity 0.5 A/15 VA.

Over limit display time: selectable, 1 s or continuously on, after limit exceeded.

Temperature range: 0°C to 50°C.

Power: 115 or 230 V $\pm 10\%$, 50-400 Hz, 25 VA max.

Size: 129 mm H x 425 mm W x 414 mm D (5 $\frac{1}{16}$ " x 16 $\frac{3}{4}$ " x 16 $\frac{3}{16}$ ").

Weight: net, 14 kg (31 lb). Shipping, 18.45 kg (41 lb).

Accessories Available

HP 16014A: Series Loss Test Adaptor is designed for measuring low-value inductors and resistors and high-value capacitors.

HP 16462A: Auxiliary Capacitor is designed to extend the Q and L measurement capability of the 4342A Q Meter. It is especially useful for measuring small inductors at low frequencies.

HP 16470A Reference Inductors: A range or 20 inductors (any of which can be supplied separately) which can be used with the 4342A Q Meter when measuring the RF characteristics of capacitors, resistors, or insulating materials.

HP 16470B Stable Inductors: A set of 4 inductors (any of which are separately available) which can be used to compensate indicated Q values and/or instrumental variation in the maintenance of the 4342A Q Meter. They are usable over a range of 800 kHz to 50 MHz with excellent long-term temperature stability.

Options and Accessories

Opt 001: Frequency Range

Opt 910: Extra Manual

16014A Series Loss Test Adaptor

16462A Auxiliary Capacitor

16470A Reference Inductors, set of 20

16470B Stable Inductors, set of 4

16470C Complete set of 24 Inductors (16470A + 16470B)

4342A Q Meter



- 20 $\mu\Omega$ resolution on 1 m Ω range
- Four terminal measurement
- Low test voltage

- Wide range: 500 k Ω to $2 \times 10^{16} \Omega$
- Selectable test voltages: 10 V to 1000 V

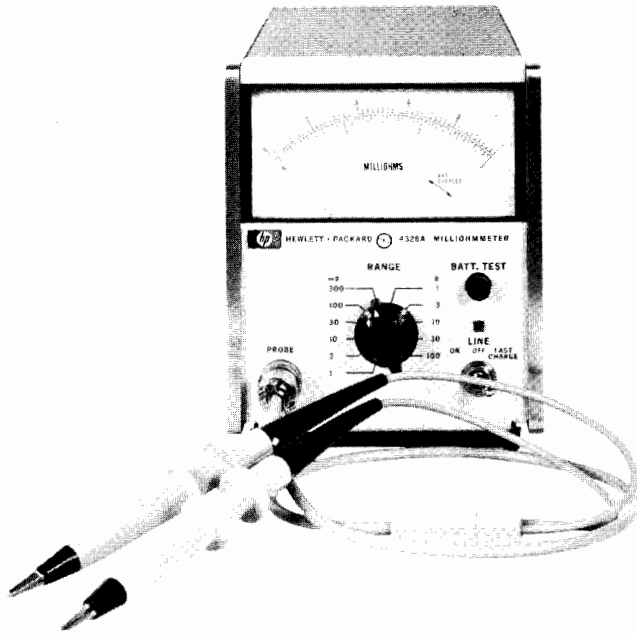

4328A

Description

HP's 4328A Milliohmmeter is a high sensitivity portable instrument for measurement of low resistances. The 1 m Ω to 100 Ω measuring range and 20 $\mu\Omega$ resolution make the 4328A ideal for measuring the contact resistance of switches, relays, and connectors and the resistivity of conductors and semiconductors. Series reactances of up to twice the full scale resistance will not affect the accuracy. The maximum voltage across a sample, with the instrument at the proper range, is less than 200 μ V peak. Even at incorrect range settings, the voltage across the sample will not exceed 20 mV peak.

The special probes that allow four-terminal measurement in two probes are furnished with the 4328A.

The basic 4328A is line operated but Opt 001 permits operation from rechargeable batteries for 15 continuous hours.

Specifications

Range: 0.001 to 100 ohms full scale in a 1, 3 sequence.

Accuracy: $\pm 2\%$ of full scale. No additional error is caused by series reactance of samples up to two times full scale.

Measuring frequency: 1000 Hz ± 100 Hz.

Voltage across sample: 200 μ V peak at full scale.

Maximum voltage across sample: 20 mV peak.

Superimposed dc: 150 V dc maximum (external source).

Recorder output: 0.1 V dc output at full scale, output resistance approx. 1 k Ω .

Applied current (mA): constant by range, 150/(full scale value in milliohms).

General

Power requirements: 115/230 V $\pm 10\%$, 50 to 60 Hz, 1.5 VA.

Weight: 3.2 kg (7 lb).

Size: 155 mm H x 130 mm W x 279 mm D (6 $\frac{1}{32}$ " x 5 $\frac{1}{8}$ " x 11").

Accessories furnished: Model 16005A Probe, 16006A Probe and 16007A/B Test Leads. 16143A Probe Cable.

Ordering Information

4328A Milliohmmeter

Opt 001: Rechargeable battery operation

Opt 910: extra manual

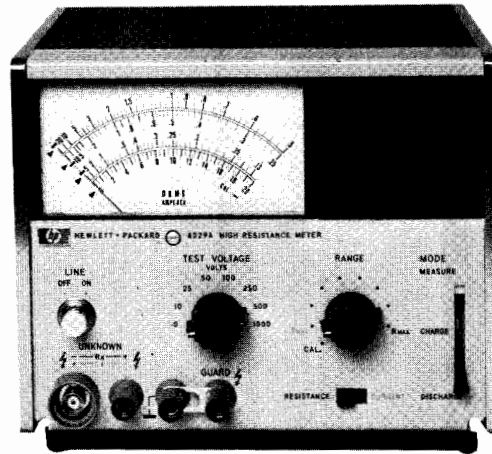

4329A

Description

The HP 4329A is a solid-state insulation resistance meter designed for easy, accurate and direct readings of the very high resistance values typically found in synthetic resins, porcelain, insulating oils and similar materials. It is also useful for measurements in electrical components like capacitors, transformers, switches and cables. Seven fully regulated dc test voltages (between 10 and 1000 Vdc) are provided as test sources.

The HP 4329A is instantly convertible from ungrounded-to-grounded-sample operation via a simple relocation of the front panel ground strap from "guard" to "+" position.

The HP 4329A also has a current measurement capability. Minute currents as low as 0.05 pA can be readily measured.

The HP 16008A Resistivity Cell, designed for use with the HP 4329A, can safely, rapidly and conveniently measure the volume and surface resistivity of sheet insulation materials (maximum sample size: 125 mm W x 125 mm D x 7 mm H).

Specifications

Resistance Measurement

Range: 500 k Ω to $2 \times 10^{16} \Omega$. (depends on the test voltage).

Accuracy: total accuracy is determined by test voltage and range used. At low resistance end of each scale, accuracy is $\pm 3\%$, near center scale $\pm 5\%$, and near the specified upper limit on the meter scale (a quarter of full scale), accuracy is $\pm 10\%$. Accuracy is not specified above these limits. On all voltage ranges, if multiplier is set to Rmax., an additional $\pm 3\%$ is included.

Test voltage: 10 V, 25 V, 50 V, 100 V, 250 V, 500 V and 1000 V $\pm 3\%$.

Current Measurement

Range: 5×10^{-14} to 2×10^{-5} A in 8 ranges.

Accuracy: $\pm 5\%$ of full scale deflection (there can be an additional $\pm 3\%$ error at the top decade).

General

Recorder output: 0 to 100 mV dc, proportional to meter deflection; 1 k Ω output resistance.

Power: 115/230 V $\pm 10\%$, 50-60 Hz, approximately 3 VA.

Size: 155 mm H x 198 mm W x 204 mm D (6 $\frac{1}{2}$ " x 7 $\frac{25}{32}$ " x 8 $\frac{25}{32}$ ").

Weight: 3.5 kg (7.7 lb).

Accessory furnished: HP 16117A Low Noise Test Leads.

Accessory available: model 16008A Resistivity Cell.

Ordering Information

16008A Resistivity cell

4329A High resistance meter

Opt 910: extra manual

COMPONENT & SEMICONDUCTOR MEASUREMENT

Vector Impedance Meter

Model 4800A

- Measures impedance, magnitude and phase
- 5 Hz to 500 kHz
- Analog outputs for impedance magnitude, phase, and frequency

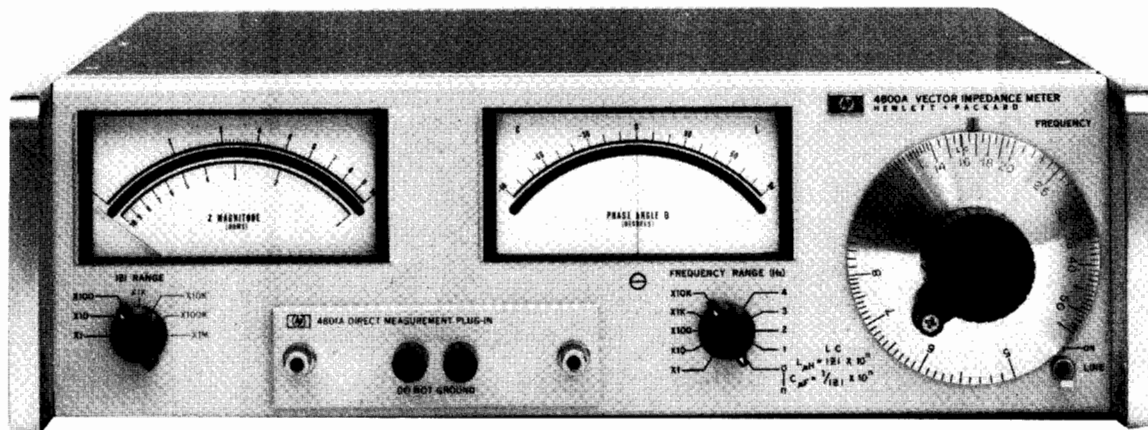

Description

Vector impedance is a quantity involving both magnitude and phase and can be graphically illustrated by a vector in the Z, θ plane. Vector impedance describes the ratio of voltage to current and phase difference between the two.

Impedance of components, complex networks, and other two-terminal devices is measured by simply connecting the "unknown" to HP's 4800A Vector Impedance Meter, selecting the desired test frequency, and adjusting the impedance range switch. Both impedance magnitude in ohms and phase in degrees are read directly. HP's Vector Impedance Meter eliminates all the tedium of traditional techniques for measuring complex impedance. It is a complete system calibrated to read the complex impedance as measured between the terminals.

HP's Vector Impedance Meter measures impedance from 1 ohm to 10 megohms over a phase range of -90° to $+90^\circ$. Frequency adjusts from 5 Hz to 500 kHz in 10 decade ranges. Three controls: impedance range switch, frequency range switch, and frequency dial, are arranged on the front panel to assure simple operation.

Besides measuring vector impedance, HP's 4800A conveniently measures components. At frequencies that are decade multiples of $1/2\pi$, as marked on the frequency dial, L and $1/C$ are read directly if the phase is approximately $\pm 90^\circ$ respectively. R is equal to the impedance magnitude at frequencies where the phase is approximately 0° . The vector impedance meter also yields Q of circuits and inductors by using either $f_0/\Delta f$, $R_p/\omega L$ or the $\omega L/R_s$ technique. A vector impedance calculator is furnished with each instrument for quick determination of equivalent series resistance, reactance, inductance, capacitance, and Q.

HP's 4800A is equipped with analog outputs for three parameters: impedance magnitude, impedance phase, and frequency. These outputs may be used in conjunction with a two-pen X-Y recorder to provide permanent traces. The rear panel provision for an external oscillator input makes possible swept frequency characterization of "unknowns". The impedance meter can be swept over any decade range of frequency and impedance within the range of the instrument. Analog outputs can also be connected to a digital voltmeter for a high resolution, digital readout with excellent repeatability.

Specifications

Frequency Characteristics

Range: 5 Hz to 500 kHz in five bands: 5 to 50 Hz, 50 to 500 Hz, 0.5 to 5 kHz, 5 to 50 kHz, 50 to 500 kHz.

Accuracy: $\pm 2\%$ from 50 Hz to 500 kHz, $\pm 4\%$ from 5 to 50 Hz, $\pm 1\%$ at 15.92 kHz on frequency dial from 159.2 Hz to 159.2 kHz, $\pm 2\%$ at 15.92 Hz.

Monitor output: level: 0.2 V rms minimum; source impedance: nominally 600 ohms in series with $50 \mu\text{F}$.

Impedance Measurement Characteristics

Range: 1 ohm to 10 megohms.

Meter scale range: 1 ohm to 10 ohms times impedance range.

Impedance ranges: X1, X10, X100, X1 k, X10 k, X100 k, X1 M.

Accuracy: $\pm 5\%$ of reading.

Phase Angle Measurement Characteristics

Range: 0° to $\pm 90^\circ$.

Accuracy: $\pm 6^\circ$.

Calibration: increments of 5° .

Direct Inductance Measurement Capabilities

Range: $1 \mu\text{H}$ to 100,000 H, direct reading at decade multiples of 15.92 Hz.

Accuracy: $\pm 7\%$ of reading for Q greater than 10 from 159.2 Hz to 159.2 kHz, $\pm 8\%$ of reading for Q greater than 10 at 15.92 Hz.

Direct Capacitance Measurement Capabilities

Range: 0.1 pF to 10,000 μF , direct reading at decade multiples of 15.92 Hz.

Accuracy: $\pm 7\%$ of reading for D less than 0.1 at 159.2 Hz to 159.2 kHz, $\pm 8\%$ of reading for D less than 0.1 at 15.92 Hz.

Measuring Terminal Characteristics

Configuration: electrical: both terminals above ground, ground terminals provided for shielding convenience; mechanical: binding posts spaced $3/4"$ at centers.

Waveshape: sinusoidal.

External oscillator requirements: 0.9 V $\pm 20\%$ into 20 k Ω .

Recorder Outputs

Frequency: level: 0 to 1 V nominal; source impedance: 0 to 1000 ohms nominal; proportional to frequency dial rotation.

Impedance: level: 0 to 1 V nominal; source impedance: 100 ohms nominal.

Phase angle: level: 0 ± 0.9 V nominal; source impedance: 1000 ohms nominal.

Accessories furnished: 13525A Calibration Resistor, 00610A Terminal Shield.

Dimensions: 426 mm W x 133 mm H x 467 mm D ($16\frac{3}{4}"$ x $5\frac{1}{4}"$ x $18\frac{3}{8}"$).

Weight: net, 10.8 kg (24 lb). Shipping, 13.5 kg (30 lb).

Power: 115 or 230 V $\pm 10\%$, 48 to 440 Hz, 29.7 VA.

4800A Vector Impedance Meter

Opt 908: Rack Flange kit

Opt 910: Extra operating and service manual

COMPONENT & SEMICONDUCTOR MEASUREMENT

Standard Air Capacitor Set and Decode Capacitor

Models 16380A, 4440B

121

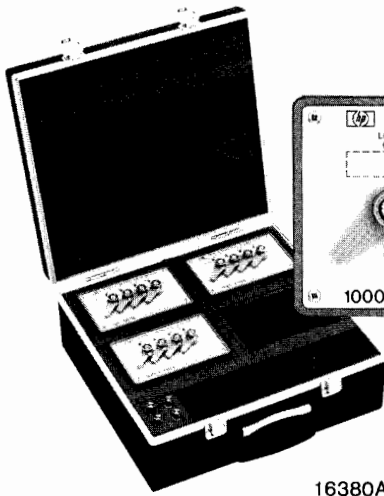

16380A

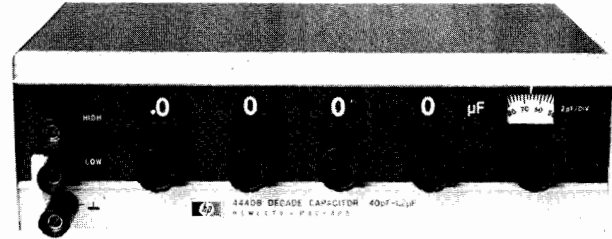
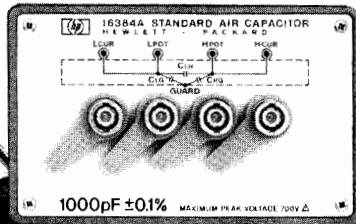

4440B

16380A Description

The HP 16380A is a set of four air-dielectric four-terminal pair configuration capacitors with values of 1, 10, 100 and 1000 pF. These standard capacitors have excellent capacitance stability (≤ 300 ppm/year) and frequency characteristics (100 Hz to 10 MHz). Each unit is supplied with test certification to 0.01% calibration accuracy at 1 kHz. This permits direct calibration of capacitance and LCR meters to an accuracy of 0.1%.

The 16380A can be easily adapted to 3, 4 and 5 terminal configurations, allowing it to be used for calibration of all Hewlett-Packard LCR meters.

16380A Specifications (at 1 kHz, $23 \pm 5^\circ\text{C}$)

	16381A	16382A	16383A	16384A
Capacitance	1 pF	10 pF	100 pF	1000 pF
Accuracy	$\pm 0.1\%$			
Dissipation Factor	≤ 0.0001			
Dimensions	112 mm H x 142 mm W x 88 mm D			
Weight	1.4 kg each, Case: 8.6 kg			

General

Frequency Characteristics

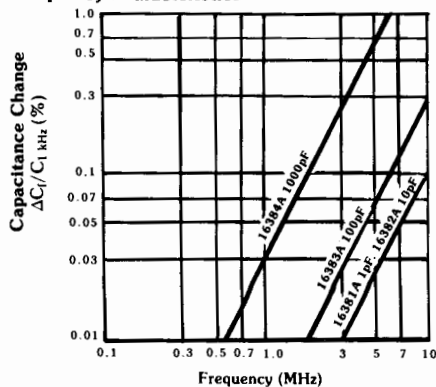

Temperature coefficient (typ.): +40 ppm/ $^\circ\text{C}$ (1 pF), +30 ppm/ $^\circ\text{C}$ (10 p, 100 p, 1000 pF)

Calibration accuracy: $\pm 0.01\%$ (certification at 1 kHz supplied).

Stability: 300 ppm/YR (at 1 kHz and $23 \pm 5^\circ\text{C}$)

4440B Description

The Hewlett-Packard 4440B Decade Capacitor is a high accuracy instrument providing usable capacitances from 40 pF to 1.2 μF . Its 0.25% accuracy makes it an ideal aid for circuit design or as a working standard.

The use of silvered-mica capacitors in all four decades provides higher accuracy, lower dissipation factor and good temperature coefficient. An air capacitor vernier provides 100 pF (from 40 pF to 140 pF) with resolution of 1 pF. Capacitors are housed in a double shield in such a way that increased capacitance from two terminals to three terminals is held to 1 pF.

4440B Specifications

Capacitance: 40 pF to 1.2 μF in steps of 100 pF with a 40 pF to 140 pF variable air capacitor providing continuous adjustment to better than 2 pF between steps.

Direct reading accuracy: $\pm (0.25\% + 3 \text{ pF})$ at 1 kHz for three-terminal connection.

Resonant frequency: typical values of the resonant frequency are 450 kHz at 1 μF , 4 MHz at 0.01 μF and 40 MHz at 100 pF

Dissipation factor: for $C > 1040$ pF, 0.001 MAX at 1 kHz.
for $C < 1040$ pF, 0.005 MAX at 1 kHz.

Temperature coefficient: $< +70$ ppm/ $^\circ\text{C}$.

Insulation resistance: 5 G Ω minimum, after 5 minutes at 500 V dc.

Maximum voltage: 500 V peak.

Weight: net 2.5 kg (5½ lb). Shipping 3.6 kg (8 lb).

Size: 76 mm H x 264 mm W x 152 mm D (3" x 11" x 6").

Ordering Information

16380A Standard Air Capacitor Set

4440B Decade Capacitor

COMPONENT & SEMICONDUCTOR MEASUREMENT

pA Meter/DC Voltage Source

Model 4140B

- 3 basic semiconductor measurements:
I, I-V and quasi-static C-V measurements
- Two programmable voltage sources
- Basic accuracy: 0.5%
- High resolution: 1.000×10^{-12}
- HP-IB standard

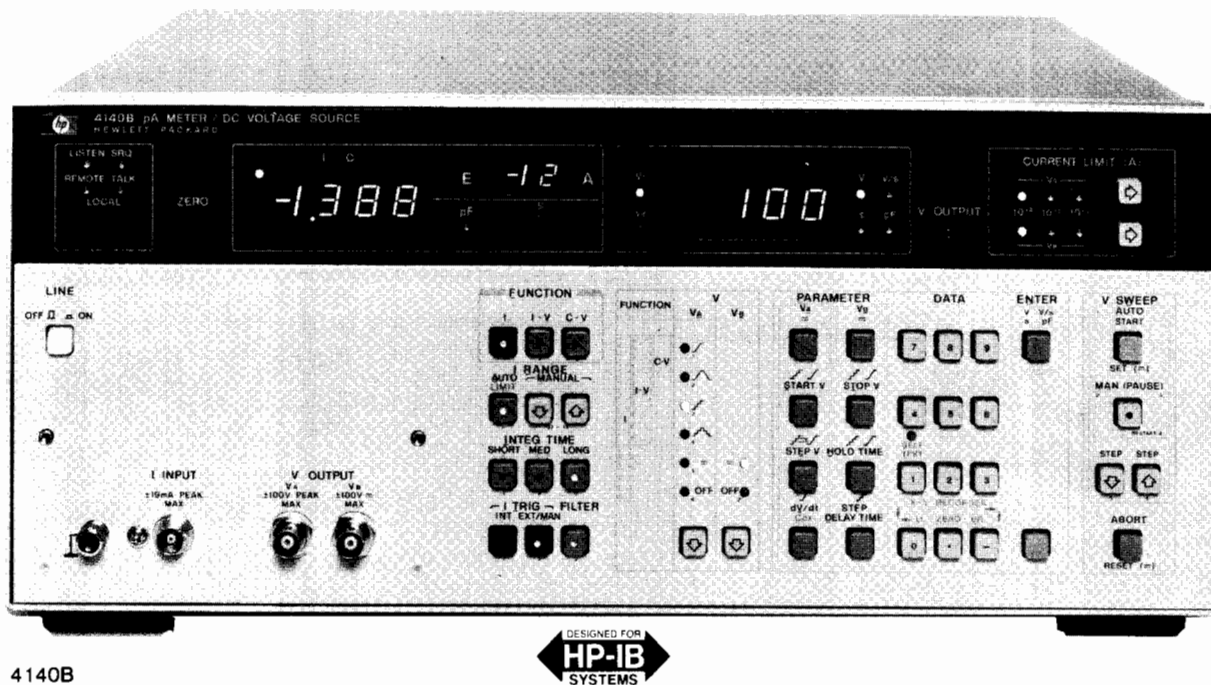

Description

The 4140B pA Meter/DC Voltage Source is another in Hewlett-Packard's new generation of Component Measurement instrumentation. It consists of an extremely stable picoampere meter and two programmable dc voltage sources, one of which operates as a ramp and staircase generator as well as a dc source. These features make the 4140B ideal for making dc characteristic measurements such as leakage current, current-voltage characteristics and quasi-static C-V measurements required by the semiconductor industry for new product development and for improving production yields. It is equally useful in measurements of electronic components and materials to determine leakage currents or insulation resistances.

The 4140B can contribute to the development, production and quality control of semiconductor devices and to the improvement in the reliability of electronic components and equipment.

Stable pA Measurements

Stable picoampere measurements can be made with the 4140B with a maximum resolution of 10^{-15} A. This is made possible by a new measurement technique in conjunction with an offset current capability, low noise test leads, and an electrostatic and light shielded test fixture. These features provide both stable and fast picoampere measurements.

This measurement technique is very useful in making small leakage current measurements and determining dc parameters of semiconductor devices or measuring the insulation resistance and leakage current for dielectric absorption measurements necessary in the analysis of capacitors or insulation materials.

Synchronized I-V Measurements

The 4140B makes automatic, synchronized current-voltage measurements that have required a large instrumentation system in the past.

The two voltage sources in the 4140B operate over a range of -100 V to +100 V with a maximum resolution of 10 mV. One operates only as a stable dc source while the other generates a staircase voltage, a precise ramp or a stable dc level.

By adding precise, programmable timing capability, we can now make fast, accurate I-V and C-V measurements. Device stabilization times, (time between the applied voltage and the subsequent current

measurement) can now be programmed from the front panel of the 4140B or via the HP-IB bus.

Quasi-Static C-V Measurements

Automatic quasi-static C-V measurements are easily accomplished by the ramp voltage capability of the 4140B. This measurement is highly significant in evaluating basic semiconductor characteristics.

The 4140B operates over a capacitance range of 0.1 pF to 1999 pF with a dc voltage ramp rate of 1 mV/s to 1 V/s in 1 mV/s increments. Capacitance, which is calculated from the measured current divided by the ramp rate, can also be provided as a percent of the capacitance of the oxide film (C_{ox}) over a range of 0.0 to 199.9%. By providing the output voltage at each capacitance measurement point, we have the dc (quasi-static) C-V characteristics of the device under test.

HP-IB Capability

Interfacing the 4140B to an HP-IB system improves measurement efficiency and takes advantage of its high speed (approx 5 ms) measurement rate. Such a system will minimize measurement time of dc parameters of semiconductors and the insulation resistance and leakage current of electric components and materials. This allows rapid feedback to production for fast evaluation of a new device in the development stage.

Specifications



Measurement functions: I, I-V and C-V

Voltage sources: two separate sources (V_A and V_B)

V_A : ± 100 V programmable source/function generator

V_B : ± 100 V programmable dc voltage source

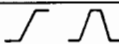
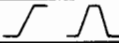
Measurement Function / Source Selection

Function	V_A	V_B
I		--- (DC)
I-V		--- (DC)
C-V		--- (DC)

Voltage sweep: auto or manual (pause)

Current Measurements

Displays: current, 3½ digits with 2 digit annunciator. Voltage, 3½ digits.

Measurement range: ± 1.000 × 10⁻¹²A to 1.000 × 10⁻²A full scale in 11 ranges.

Overrange capability: 99.9% on all ranges.

Range selection: auto (lowest current range is selectable), and manual

Measurement Accuracy/Integration Time

Range	Accuracy* ± (% of rdg. + counts)	Integration Time** (ms)		
		Short	Medium	Long
10 ⁻² - 10 ⁻⁹	0.5 + 2	20	80	320
10 ⁻¹⁰	2 + 2			
10 ⁻¹¹	5 + 3	80	320	1280
10 ⁻¹²	5 + 8	160	640	2560

* Accuracy for long integration time. 23°C ± 5°C. humidity ≤ 70%. For short and medium integration time, see reference data section.

** Integration times specified at 50 Hz. For 60 Hz operation, multiple time by %.

Zero offset: cancels leakage current of test leads or test fixtures.

Offset range: 0 to ± 100 × 10⁻¹⁵A.

Trigger: INT, EXT and HOLD/MAN

Input terminal: triaxial

Capacitance-Voltage (C-V) Measurement

Measurement ranges: 0.0 pF - 100.0 pF and 200 pF - 1000 pF F.S. in two ranges; 99.9% overrange

Ranging: auto

%C: capacitance change of device under test is displayed as a percent of the set value of the oxide capacitance (Cox = 100%)

%C range: 0.0% - 199.9%

Cox setting ranges (2 ranges): 0.1 pF - 199.9 pF and 200 pF - 1999 pF

Capacitance calculation accuracy: accuracy is dependent on accuracy of both the current measurement and ramp voltage.

Zero offset: cancels stray capacitances of test fixtures and test leads.

Offset range: 0 to 100 pF

High speed I data output: available with HP-IB interface only. Outputs current measurement data at 4 ms intervals (max rate).

DC Voltage Sources

Output Modes, VA:

VB:

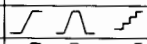
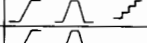
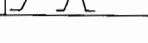
Function	VA	VB
I		--- (DC)
I-V		--- (DC)
C-V		--- (DC)

Voltage ranges (VA and VB): 0 to ± 10.00 V and 0 to ± 100.0 V in 2 ranges, auto range only.

Maximum current: 10 mA, both sources.

Voltage sweep: auto and man (pause), up/down step in manual (pause) mode. Sweep abort standard

Operating Parameter Setting Ranges

Start voltage and stop voltage: 0 - ± 10.00 V, 0.01 V steps; 0 - ± 100.0 V, 0.1 V steps

Step voltage: 0 - ± 10.00 V, 0.01 V steps; 0 - ± 100.0 V, 0.1 V steps

Hold time: 0 - 199.9 seconds in 0.1 s increments; 0 - 1999 seconds in 1.0 s increments

Step delay time: 0 - 10.00 seconds in 0.01 s increments; 0 - 100.0 seconds in 0.1 s increments

Ramp rate (dV/dt): 0.001 V/s - 1.000 V/s in 0.001 V/s increments

Accuracy (at 23°C ± 5°C)

Output voltage: ± 10 V, ± (0.07% + 11 mV); ± 100 V, ± (0.09% + 110 mV)

Ramp rate: typically 0.5%, 0 - ± 10 V; < 5 %, > 10 V.

Current limit: 100 µA, 1 mA and 10 mA, ± 10% (VA and VB)

Output terminals: BNC; L-GND

Reference Data

Current Measurement

Current Measurement Accuracy*

Range	Integration Time	
	Short	Medium
10 ⁻² - 10 ⁻⁸	0.5 + 3	0.5 + 2
10 ⁻⁹	0.5 + 3	0.5 + 3
10 ⁻¹⁰	2 + 4	2 + 3
10 ⁻¹¹	5 + 10	5 + 4
10 ⁻¹²	5 + 20	5 + 10

* ± (% of rdg. + counts), 23°C

Current ranging times: 21 ms to 3.8 sec. (longer ranging time needed for large changes in input signal level, especially on lowest current ranges).

*When FILTER is on, current ranging time increases 60 ms (50 Hz power line) or 50 ms (60 Hz power line)

Warm-up time: ≥ 1 hour

Common mode rejection ratio: ≥ 120 dB (≤ 2 counts)

Analog Output I, C and VA

Accuracy: ± (0.5% + 20 mV)

Low pass filter: 3 position: OFF, 0.22 s ± 20% and 1s ± 20% applied to both VA and I/C data outputs

Pen lift output: TTL low level (≤ 0.8V) during sweep period in I-V and C-V functions

Recorder output scaling: pushbutton scaling of lower left and upper right limits of X-Y recorder

HP-IB Interface*

Remote controlled functions: measurement function, current range, integration time, I data output trigger, voltage sweep controls, current limit, VA and VB voltages, zero (offset), self test and parameter settings (voltages, sweep/hold/delay times)

Data Output

Measured data (I, C and VA),

Voltage setting (VA and VB),

Parameter settings

*HP-IB cables not supplied; see page 37.

General Information

Power: 100, 120, 220, V ± 10%, 240 V +5% - 10%; 48-66 Hz, 135 VA max with any option

Size: 426 mm W x 177 mm H x 498 mm D (16.5" x 7" x 19.6").

Weight: 14.4 kg (31.7 lbs.)

Accessories Furnished

16053A test leads: consists of one triaxial cable, two each BNC-BNC cables and one connection plate with mating female panel-mount connectors. Cables are one meter in length.

16055A test fixture: for general device measurements. Provides electrostatic and light shielding for stable pA measurements.

Accessories Available

16054A connection selector: provides a simple method to select appropriate connection of low lead for the pA meter section.

16056A current divider (10:1): for use only on the 10 mA range to extend the measurement capability to 100 mA.

Ordering Information

Accessories

16053A Test Leads (furnished)

16054A Connection Selector

16055A Test Fixture (furnished)

16056A Current Divider (10:1)

Options

Opt 907 Front Handle Kit (P/N 5061-0090)

Opt 908 Rack Flange Kit (P/N 5061-0078)

Opt 909 Rack & Handle Kit (P/N 5061-0084)

Opt 910 Extra Manual

4140B pA Meter/DC Voltage Source



COMPONENT & SEMICONDUCTOR MEASUREMENT

Semiconductor Parameter Analyzer

Model 4145A

- Fully automatic, high speed dc characterization of semiconductor devices and materials
- Four programmable stimulus/measurement units capable of high resolution, wide range sourcing and sensing ... I: 1 pA~100 mA, V: 1 mV~100 V
- Built-in graphics analysis functions
 - marker and cursor provide direct numeric readouts
 - line function for automatic calculation of line gradient and X-Y axes intercept values
- Built-in flexible disc drive for permanent storage of user programs and measurement results

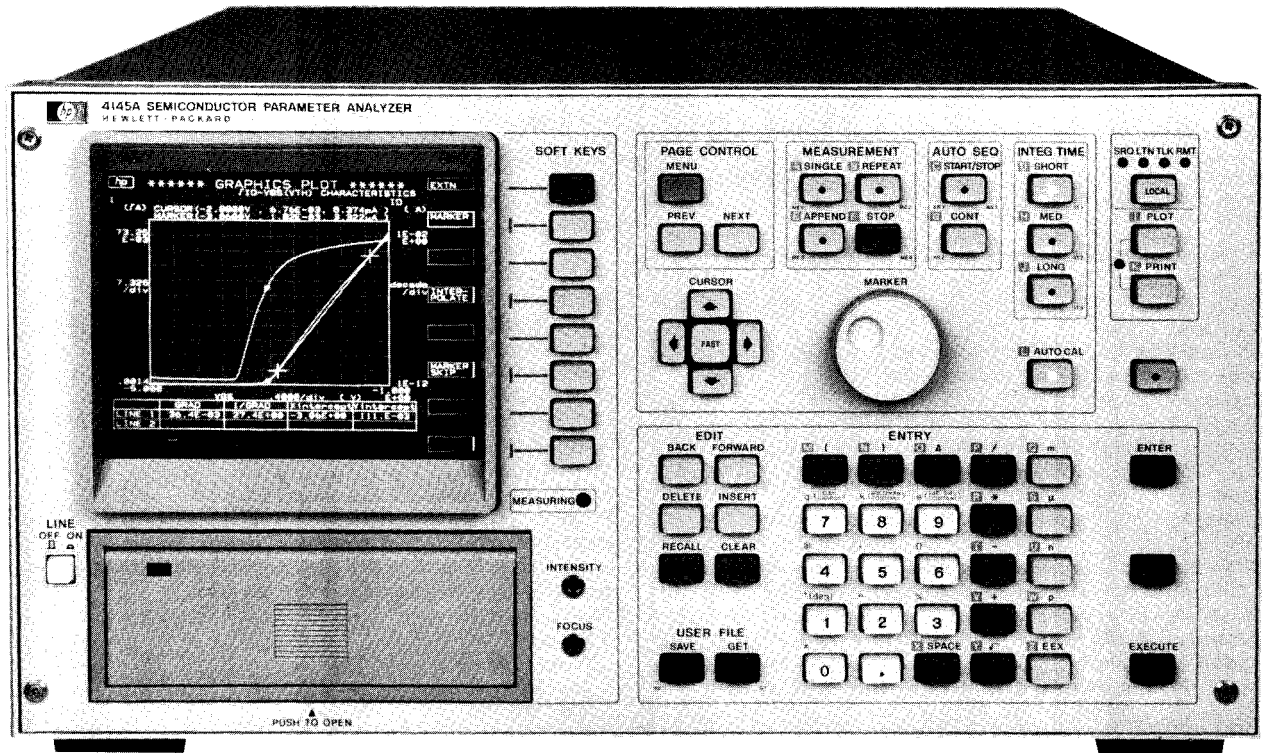

Description

Designed for production line and laboratory use, the HP 4145A is the electronics industry's first stand-alone instrument capable of complete dc characterization of semiconductor devices and materials. It stimulates voltage and current sensitive devices, measures the resulting current and voltage responses, and displays the results in a user-selectable format (graph, list, matrix or schmo) on a built-in CRT display. An on-board programmable calculator provides real-time calculation of voltage/current dependent parameters, such as the current gain (h_{FE}) and transconductance (g_m) of transistors, which also can be displayed on the CRT. A number of powerful graphic analysis tools—marker, cursor, line function, interpolation—enhance the 4145's basic capabilities and provide fast, accurate analysis of semiconductor devices, leading to increased production yields and improved device quality.

Four built-in stimulus/measurement units (SMUs) are the heart of the 4145A. Each SMU can be independently programmed to function as either a voltage source/current monitor or a current source/voltage monitor. Thus, a bipolar transistor, for example, can be completely characterized in common-base, common-emitter, and common-collector configurations without changing connections—only changing the SMUs' operating modes is required. The HP 4145A is also equipped with two voltage sources and two voltage monitors for measurements on devices having more than four terminals, such as ICs.

The HP 4145A can be controlled from the front panel, via the HP-IB (standard), or by measurement setups stored on flexible discs.

Displayed information—measurement setups, auto-sequence programs, measurement results—can be dumped directly onto an external digital printer/plotter to obtain publication quality hard copies. Also, measurement results can be sent via the HP-IB to a computer for further processing.

Auto Sequence Programs

Measurement programs stored on a 4145A flexible disc can be linked by an auto sequence program, making it possible to perform a series of measurements with just one keystroke.

Four User-Selectable Display Formats to Suit the Evaluation

Measurement results can be displayed in one of four display formats: GRAPHICS, LIST, MATRIX or SCHMOO. After measurement has been made and the results displayed, the softkeys can be used to access various analysis functions for complete device evaluation. These functions include MARKER for numeric readout of measured value at any point along a plotted curve, CURSOR for numeric readout of value at any graphic point and for line positioning, STORE /RECALL for overlay comparisons, AUTO SCALE for optimum graphic scaling, and LINE FUNCTION for direct readout of line gradient and X-Y axes intercept values.



Specifications

Measurement

Stimulus measurement unit (SMU): four SMUs are built into the HP 4145A. Each SMU can be programmed to source voltage and monitor current, or conversely to source current and monitor voltage. Each SMU can also be programmed to COM mode. This sets voltage at 0 volts and current compliance at 105 mA.

Output/measurement resolution: voltage, 4½ digits. Current, 4 digits

Voltage measurement input resistance/current source output resistance: $\geq 10^{12} \Omega$

Maximum capacitive load: 1000 pF

SMU Voltage Range, Resolution and Accuracy

Voltage Range	Resolution	Accuracy ^{1,2}	Max. Current
±20 V	1 mV	±(0.1% of reading + 0.05% of range + $0.4 \Omega \times I_{out}^*$)	100 mA
±40 V	2 mV		50 mA
±100 V	5 mV		20 mA

* I_{out} is SMU output current in amps.

SMU Current Range, Resolution and Accuracy

Current Range	Resolution	Accuracy ^{1,2}	Max. Voltage
±100 mA	100 μ A	±[0.3% + (0.1 + 0.2 × $V_{out}^*/100$)%]	20 V ($I > 50$ mA) 40 V (20 mA < $I \leq 50$ mA) 100 V ($I \leq 20$ mA)
±10 mA	10 μ A		100 V
±1000 μ A	1 μ A		
±100 μ A	100 nA		
±10 μ A	10 nA		
±1000 nA	1 nA	±[0.5% + (0.1 + 0.2 × $V_{out}^*/100$)%]	100 V
±100 nA	100 pA		
±10 nA	10 pA	±[1% + (0.1 + 0.2 × $V_{out}^*/100$)% + 5 pA]	100 V
±1000 pA	1 pA**		

* V_{out} is SMU output voltage in volts.

**50 fA resolution in current monitor mode.

- Accuracy specifications are given as $\pm\%$ of reading or setting value $\pm\%$ of range.
- Accuracy tolerances are specified at 25°C $\pm 5^\circ$ C, after a 40 minute warm-up time, with AUTO CAL on, and specified at the rear panel connector terminals referenced to SMU common. Tolerances are doubled for the extended temperature range of 10°C to 40°C.

SMU Voltage/Current Compliance

Maximum voltage compliance: 20 V, 40 V, or 100 V, depending on the output current range.

Maximum current compliance: 20 mA, 50 mA, or 100 mA, depending on the output voltage range.

Compliance setting resolution: same as current and voltage output/measurement resolution. Maximum current compliance resolution, however, is 50 pA.

Compliance accuracy: voltage compliance accuracy is the same as voltage output/measurement accuracy. Current compliance accuracy is current output/measurement accuracy \pm (1% of range + 10 pA).

Voltage/current sweep characteristics: output from up to three SMUs or voltage sources can be swept in one of three modes: VARI, VAR2, or VARI'.

VAR1: linear or logarithmic staircase sweep

VAR2: linear staircase sweep. Output from the VAR2 source is incremented after completion of each VARI sweep.

VARI': output from the VARI' source is synchronized with VAR1 but at levels proportional to a user-selectable ratio or offset relative to VARI.

Ratio: ± 0.01 to ± 10

Offset: any value that will not cause VARI' to exceed maximum allowable output.

Hold time: 0 to 650 seconds, \pm (0.5% + 9 ms) with 10 ms resolution

Delay time: 0 to 6.5 seconds, \pm (0.1% + 5 ms) with 1 ms resolution

Voltage Sources (Vs) Characteristics

Number of sources: two

Output resistance: $\geq 0.2 \Omega$

Maximum capacitive load: 1000 pF

Voltage Output Range, Resolution and Accuracy

Output Voltage Range	Resolution	Accuracy	Max. Output Current
±20 V	1 mV	±(0.5% of setting + 10 mV)	10 mA

Voltage Monitors (Vm) Characteristics

Number of monitors: two

Input resistance: 1 M Ω \pm 1% shunted by 100 pF \pm 10%

Voltage Measurement Range, Resolution and Accuracy

Measurement Voltage Range	Resolution	Accuracy
±2 V	100 μ V	±(0.5% of reading + 10 mV)
±20 V	1 mV	±(0.2% of reading + 10 mV)

Characteristics Common to SMUs, Voltage Sources & Voltage Monitors

Maximum allowable terminal voltage: 100 V peak across SMU and V_m input terminals, or SMU and V_S output terminals, or between those terminals and guard; and 42 V maximum from Common to Ground.

Display

CRT size and screen resolution: 152.4 mm (6 inch) diagonal. 2048 x 2048 points.

Display modes: Graphics, Schmo, List and Matrix

External CRT analog output: X, Y and Z outputs of 0 to 1 Vdc into 330 Ω (X and Y) and 240 Ω (Z).

Analysis

Calculation: two user functions can be input and keyboard calculations can be done using the following 11 operators: +, -, *, /, $\sqrt{\quad}$, EXP, LOG, LN, ** (power), ABS (absolute) and Δ (differential).

Constants Available on the Keyboard

q: Electron charge (1.602189×10^{-19} coulomb)

k: Boltzmann's Constant (1.380662×10^{-23} J/ $^\circ$ K)

e: Dielectric constant of vacuum (8.854185×10^{-12} F/m)

Analysis functions: overlay comparison with STORE/RECALL, Marker, Interpolate, Cursor, Auto scale, Zoom function (\leftarrow , \rightarrow , \uparrow , \downarrow), Line and Move Window.

General Specifications

Operating temperature range: +10°C to +40°C; $\leq 70\%$ RH at 40°C, permissible temperature change $\leq 1^\circ$ C/5 min.

Power requirements: 100/120/220 V $\pm 10\%$; 240 V - 10% + 5%; 48 to 66 Hz; 270 VA max.

Dimensions: 426 mm W x 235 mm H x 612 mm D (16.75" x 9.06" x 24.1").

Weight: 27 kg (59 lbs) approximately.

Reference Data

SMU Measurement time: measurement time = response time + ranging time + integration time.

SMU Response Time

Current Range	Setup/Settling Time	SMU Wait Time
100 nA to 100 mA 1 nA and 10 nA	2.7 ms	0.2 ms 47.5 ms

Ranging time: varies from 4 ms to 74 ms

Integration time: SHORT, MED and LONG

	SHORT	MED	LONG
50 Hz	3.6 ms	20 ms	320 ms
60 Hz		16.7 ms	267 ms

Accessories Furnished

16058A Test Fixture

04145-60001 Connector Plate

04145-61622 Triaxial Cable (3m), 4 ea.

04145-61630 BNC Cable (3m), 4 ea.

04145-61623 Shorting Connector

04145-61100 5 System Discs with a Head Cleaning Disc

(P/N9164-0168)

Ordering Information

HP 4145A Semiconductor Parameter Analyzer

COMPONENT & SEMICONDUCTOR MEASUREMENT

Semiconductor/Component Test System Model 4061A

- Ready to use—supplied with 7 turn-key application pacs
- Reliable impedance and current measurements with one probing
- Productivity improvement through accurate and fast measurement over wide range

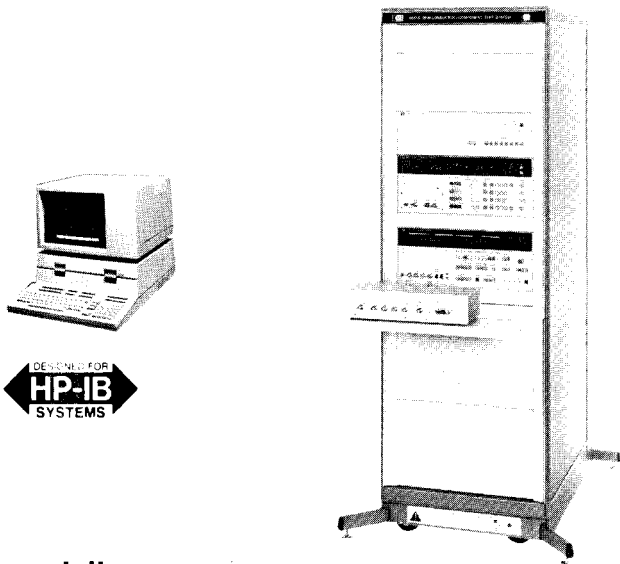

Description

The 4061A Semiconductor/Component Test System is a dedicated system for making efficient, automatic evaluation of the fundamental characteristics of semiconductor and electronic components required in R & D and production areas. This system employs reliable, accurate measurements and high speed data processing to perform more reliable evaluations with speed and less manpower. The 4061A is supplied with 7 sophisticated applications programs and is flexible in both software and hardware. Thus, the system can output measurement results in nearly any required data format.

The switching subsystem, designed especially for use with the 4061A, allows both impedance and current measurement without changing DUT connection. Using this new switching subsystem, and by making impedance measurements, the 4061A performs evaluation of Doping profile, Oxide capacitance, Flat band condition, Threshold voltage, Surface charge, and Minority carrier life time/surface generation velocity. The 4061A also measures leakage current and reverse/forward current-voltage characteristics. Surface state density evaluation, using both high (e.g., 1 MHz) and low frequency (Quasi-static) C-V measurements and data processing are also possible by making modifications to system software.

The system offers significant improvement in both yield and quality in production through fast and reliable measurements and evaluations. It is also a valuable evaluation tool for the development of new materials and devices. The 4061A provides the flexibility to meet the future measurement requirements of the electronics industry.

System Configuration

The 4061A consists of the following:
 4140B pA Meter/DC Voltage Source
 4275A Multi-frequency LCR Meter
 Switching Subsystem
 System controller can be chosen from 9826A/S, 9836A/S or 9845B desktop computers
 29402C 56-inch Rack Cabinet

Impedance Measurement

The 4275A Multi-frequency LCR Meter offers excellent flexibility in measuring the impedance characteristics of semiconductors, LCR components and electronic materials. The 4275A's flexibility enables tests to be performed at test frequencies, test signal levels and DC bias voltage equivalent to, or very near actual operating conditions.

The 4275A offers up to 5½ digit resolution, wide measurement range (0.01 fF to 199,999 μF) basic accuracy of 0.1% over a 10 kHz to 10 MHz frequency range.

Current Measurement

The 4140B pA Meter/dc Voltage Source offers stable current from 0.001 pA to 20 mA. Two programmable ± 100 VDC voltage sources are also built in. Fast, accurate I-V characterization of FETS and diodes are made easy using microprocessor timing control between the voltage sources and pico-ammeter. The 4140B also performs reliable quasi-static C-V measurement with high sensitivity and stability by using a highly linear ramp biasing technique.

Switching Subsystem

The switching subsystem remotely changes DUT connection between the 4275A and 4140B. Thus, with one probing, the measurement cabling is automatically controlled and wide measurement range for both impedance measurements, up to 1 MHz, and current measurements, down to 0.001 pA are guaranteed.

This switching subsystem includes an 8 bit data I/O function with 2 bit interrupt input for interface versatility. Non-HP-IB products such as IC probers, temperature controls, or component handlers can be interfaced through this 8 bit I/O. Of course, other HP-IB compatible products can be interfaced, allowing greater flexibility in both measurement and data processing.

Controller

Standard controller for the 4061A can be selected from several desktop computers: 9826A/S, 9836A/S and 9845B. The system controller provides 1) control functions via HP-IB interface and 2) complex data processing needed for evaluation of semiconductors and electronic components.

System Software

System software consists of 7 turn-key application programs, 28 system subroutines, and 4 diagnostics. The application software is ready to use to perform basic semiconductor characterizations and component impedance evaluations. System subroutines are usable as major program subroutines to expand system measurement and data processing capabilities. The diagnostics isolate parts of the system not operating properly and can be used to verify system operation before making measurements.

Furnished Application Software

Semiconductor high/low frequency C-V characteristics, I-V characteristics, C-t characteristics and Zerbst analysis, Impedance Frequency/Bias characteristics, Ideal C-V curve.

Semiconductor Applications

C-V Characteristics

The 4061A measures the C-V characteristics of MIS structures. Both high frequency C-V (10 kHz to 1 MHz) and low frequency C-V (quasi-static) characteristics are easily measured. Using data from the C-V characteristics measurement, a doping profile is easily obtained.

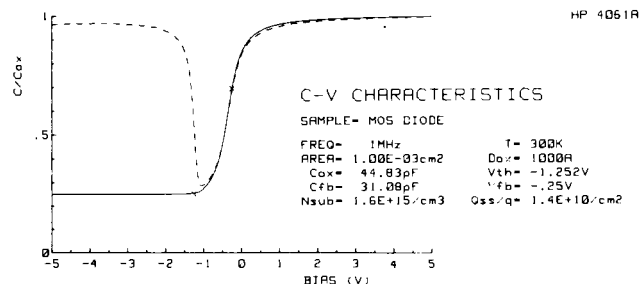

The 4061A performs the Zerbst analysis using the C-t measurement data. This analysis is an effective evaluation method for obtaining the semiconductor minority carrier generation characteristics.

I-V and DC Characteristics

Total synchronization between the application of the voltage and the current measurement is automatically accomplished by the 4061A. This permits the accurate (0.5%) and high speed (35 ms on the 1 nA range) measurements necessary to measure small leakage currents in MOS structures, FET's, and diode static characteristics.

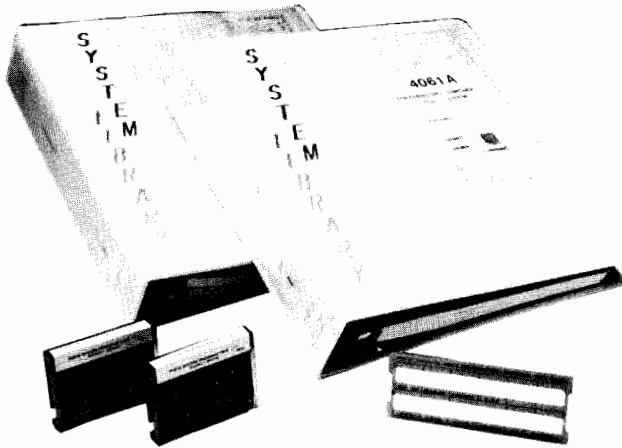
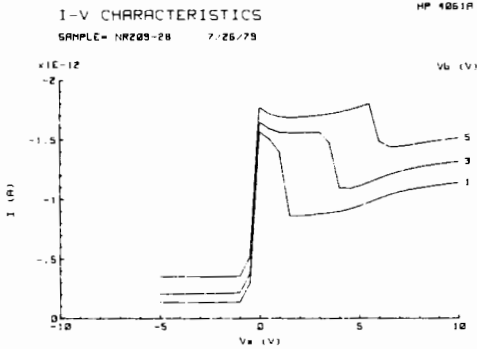

4061A System Library

Specifications

For detailed specifications on each of the instruments used in the 4061A, refer to the individual data sheets.

Impedance Measuring Section (4275A)

These specifications are for the 4275A connected directly to the device-under-test (DUT).

Display: 4½ digits; 5½ digits in high resolution mode

Frequency: 10 kHz to 10 MHz; 10 spot frequencies in a 1-2-4 step sequence.

Oscillator level: 1 mVrms continuously variable into open circuit. Output impedance approximately 100 ohms.

Measurement parameters: C-D•Q•ESR•G, L-D•Q•ESR•G, R-X•B•L•C, |Z|•θ

Measurement Ranges

C: 0.01 fF to 199.99 μF

L: 1 pH to 19.999 H

|Z|, R, X: 0.01 mΩ to 19.999 MΩ

G, B: 0.01 nS to 19.999 S

D: 0.0001 to 9.9999

Q: 0.01 to 9900

Basic accuracy: ±0.1%

Measurement time: approximately 140 ms to 210 ms

DC Bias (4275A Option 001): 0 to ±35 V, 1 mV maximum resolution.

Current Measurement Section (4140B)

These specifications are for the 4140B connected directly to the device-under-test.

Measurement functions: I, I-V, and C-V. Synchronized measurements of Current-Voltage (I-V) and Quasi-Static (C-V) are automatically performed.

Current Measurement

Display: 3½ digit

Range: ±0.001 × 10⁻¹² A to 1.999 × 10⁻² A

Basic accuracy: ±0.5%

Measurement time: approximately 5 ms to 9 s

DC voltage sources: V_A and V_B

Output mode: V_A; V_B;

Range: both sources, 0 to ±10 V in 10 mV steps; 0 to ±100 V in 100 mV steps; Ramp Rate, (V_A only), 0.001 V/s to 1 V/s

Capacitance-Voltage (C-V Measurement)

Measurement ranges: 0.0 pF to 199.9 pF and 200.0 pF to 1999 pF F.S. in two ranges; 99.9% overrange.

Switching Subsystem

The switching subsystem consists of a switch control module and switching module with interconnecting cables.

Function: Switches connection from DUT to either Multi-frequency LCR Meter or the pA Meter/DC Voltage source.

System Measurement Range (only deviations from individual instrument specifications are listed.)

Impedance Measurements (4275A)

Frequency range: 1 MHz

Measurement parameters: C-G

Capacitance: ≤200 pF (With D≤0.1)

Accuracy: (accuracy of 4275A) × 1.5 + ΔC (at 25°C + 5°C).

$$\Delta C = 1.4 \times 10^{-3} C x f^2 \text{ (pF)} + 5 \text{ counts}$$

Conductance: ≤12 mS (D ≤0.1)

*Accuracy: (accuracy of 4275A) × 1.5 + ΔG (at 25°C + 5°C)

$$\Delta G = 6 \times 10^{-3} C x f(S) + 5 \text{ counts}$$

*After 1 hour warmup and at DUT terminal of switching module f: frequency in MHz

Cx: Measured capacitance value in pF

At 5°C to 40°C, ΔC and ΔG doubles (Example: Assume C_x = 1000 pF and f = 1 MHz). C = (1.4 × 10⁻³ • 10³ • (1)²) pF + 5 counts = 1.4 pF + 5 counts

Current Measurements (4140B)

Accuracy: (accuracy of 4140B) × 1.5 + 5 counts

After one-hour warmup and at DUT terminal of switching module

Available Options

Option 001: ±100 V internal dc bias; 4275A internal bias is changed to ±100 V with 0.1 V resolution

Option 002: 1-3-5 frequency step; 4275A frequency steps are in a 1-3-5 sequence

Option 026: System library for 9826A/S controller is added

Option 036: System library for 9836A/S controller is added

Option 045: System library for 9845B option 175 controller added

Option 046: System library for 9845B option 275/280 controller added

General Information

Operating temperature: 5°C to 40°C

Relative humidity: 70% at 40°C

Power: 100, 120, 220, and 240 V, +5% to 10%, 48 to 66 Hz, 520 VA

Size: 535 mm W x 1635 mm H x 770 mm D (21" x 64.4" x 30.3")

Weight: Approximately 125 kg (275 lbs.).

Ordering Information

Option 001: ±100 V dc Bias for 4275A

Option 002: 1-3-5 Frequency Steps for 4275A

Option 026: System library for 9826A/S controller

Option 036: System library for 9836A/S controller

Option 045: System library for 9845B option 175 controller

Option 046: System library for 9845B option 275/280 controller

4061A Semiconductor/Component Test System (Includes 9836S Computer)



COMPONENT & SEMICONDUCTOR MEASUREMENT

Semiconductor Parametric Test System

Model 4062A

- Probed wafer measurements with 1 pA resolution
- Easy to program
- Virtual front panel simplifies operation

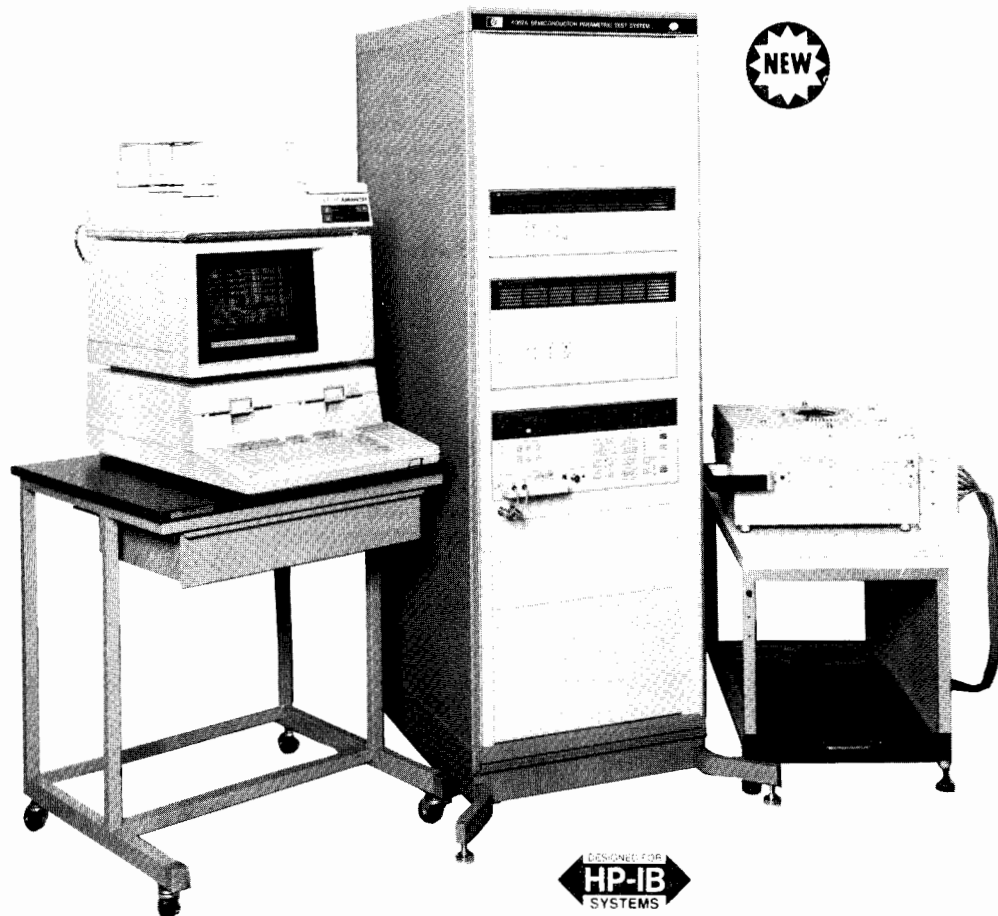

(System controller, printer and tables are not included in the 4062A)

Description

The 4062A Semiconductor Parametric Test System is a fully-automatic, computer controlled system designed to measure the DC characteristics and the 1 MHz capacitance characteristics of semiconductor devices and materials. The system is ideally suited to semiconductor wafer process and design evaluation, new device research and development departments and semiconductor manufacturing laboratories.

Specially designed system circuitry virtually eliminates the effects of environmental noise and reduces leakage current to a negligible level, thereby enabling high resolution DC current measurements down to 1 pA.

Standard system hardware consists of three rackmounted instruments and a switching matrix. The standard system is equipped with 48 measurement pins (max.) and 1 pA resolution is guaranteed for any pin configuration.

Powerful system software furnished with the 4062A ensures measurement programming ease. Programming is greatly simplified with the aid of specially prepared commands and statements contained in the Utility Library.

By providing fast, accurate measurement of DC and 1 MHz parameters of discrete, packaged and wafer-stage semiconductor devices, the 4062A offers significant improvements in production yields and throughput.

System Accuracy

The auto calibration features of each system component ensures system measurement accuracy. The advanced design of the switching matrix effectively eliminates environmental noise as an error source while reducing leakage to a negligible level. Series resistance and residuals of test cables can also be compensated. System performance can be quickly verified by using the system test module.

Text Fixtures

The wide variety of 4062A test fixtures enables the testing of many types of devices. Five test fixtures are furnished, and devices of almost any conceivable configuration from 2 pins to 48 pins can be tested.

Virtual Front Panel

The 4062A Virtual Front Panel (VFP) enables the user to set measurement conditions from the controller keyboard and to monitor measurement results on the controller CRT.

The VFP allows the system to be operated just as if there were actual front panels for each system component. For example, when measuring threshold voltage of a MOSFET, pin assignment, drain, and gate voltages can be easily set from the keyboard of the controller. By using the rotary knob on the controller, the user can vary the voltage applied to the gate while monitoring drain current. When the appropriate drain current is obtained, threshold voltage has been reached. And all this is accomplished without a program.

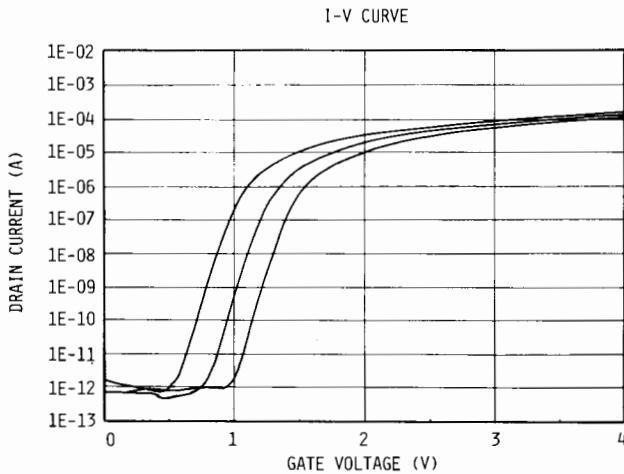

System Software

Full automatic system operation, from measurement (e.g., I-V, C-V, and C-t) to wafer prober control to analysis (wafer mapping, histograms, etc.), can be performed with simple program statements contained in the Utility Library.

Utility Libraries

Test Instruction Set

Setting/Monitor statements: 14 types (prober control statements optional)

Parameter Measurement Library

Resistance Measurements (2 probe/4 probe), Breakdown Voltage Measurements, DC Current Gain Measurements, Drain Current Measurements, Threshold Voltage Measurements (3 types), Lateral Diffusion Effect Measurements (ΔL and ΔW)

Swept Measurement Library

I-V Measurements, C • G - V Measurements, C • G - t Measurements

Characteristic Graph Library

Linear-Linear Graph (2 types), Linear-Log Graph

Wafer Prober Library

Probing Pattern Generator, Prober Control

Data Processing Library

Wafer Map, Histogram, Scatter Plot, Control Chart

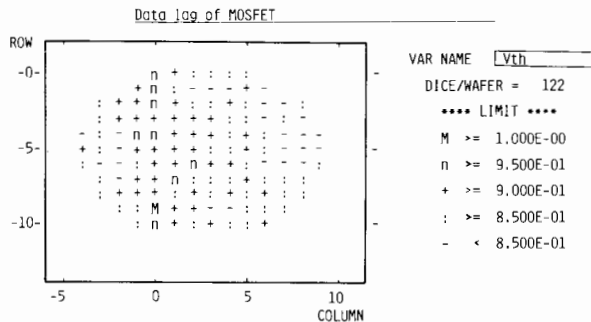

Specifications

Switching Matrix

Number of pins (to DUT): 48 pins (standard) with options for 12, 24 and 36 pins.

Number of ports (to instrument): 9 ports

High Resolution Source and Monitor Unit: 1 port

Source and Monitor Units: 3 ports

Ground: 1 port

C Measurement: 2 ports

Auxiliary: 2 ports

Maximum allowable voltage between ports: 220 VDC

Maximum allowable current at pins: 500 mAdc

Maximum stray capacitance between pins: 6 pF

DC Source and Monitor Units

High resolution source and monitor unit (SMU*1): 1 channel
Output/Measurement Range: Current, ± 1 pA - ± 100 mA; Basic Accuracy, 0.3%; Voltage, ± 1 mV - ± 100 V, Basic Accuracy, 0.1%

Source and monitor units (SMU*2-4): 3 channels
Output/Measurement Range: Current, ± 100 pA - ± 100 mA; Basic Accuracy, 0.3%; Voltage, ± 1 mV - ± 100 V; Basic Accuracy, 0.1%

Ground unit: 1 channel
Output Voltage: 0V; Accuracy, ± 2 mV

Voltage source (Vs): 2 channels
Output Range: ± 1 mV = ± 20 V; Basic Accuracy, 0.5%

Voltage monitor (Vm): 2 channels
Measurement Range: ± 100 μ V - ± 20 V, Basic Accuracy, 0.2%

* SMU 1-4: Each SMU can function either as a dc voltage source/current monitor or as a dc current source/voltage monitor.

Capacitance-Conductance Measurements

Test frequency: 1 MHz \pm 0.01%

OSC level: 30 mVrms \pm 20% and 10 mVrms \pm 20%

Measurement range: C; 0.001 pF - 1.2 nF; Basic Accuracy, 0.5%
G; 0.01 μ S - 12 mS; Basic Accuracy, 1.5%

DC bias voltage for capacitance measurements: ± 100 V

General Specifications

Operating temperature range: 10°C - 40°C, \leq 70% RH at 40°C

Permissible temperature change: \leq 1°C/5 min.

Air cleanliness: class 100,000 or better clean room required

Power requirements: 100 V, 200 V: 10%; 120 V, 240V: +5% - 10%
48 - 66 Hz, 510 VA max.

Dimensions: cabinet, 535 mm (W) x 1635 mm (H) x 770 mm (D)
Switching Matrix, 406 mm (W) x 210 mm (H) x 380 mm (D)

Weight: cabinet, approximately 250 kg
Switching Matrix, approximately 22 kg

4062 Furnished Accessories

- 16066A: Test Fixture Adapter
- 16067A: 24 pins DIP Low Leakage Fixture
- 16068A: 48 pin DIP Low Leakage Fixture
- 16069A: Universal Low Leakage Fixture
- 16070A: General Purpose Dip Fixture
- 16071A: Universal Fixture
- 16072A: Personality Board (for connecting probe card)
- 16075A: Relay Test Adapter
- 16076A: System Test Module
- 16077A: Extension Cable Fixture

System Controller

Required Controller: HP 9836A or 9836S Desktop Computer

System Language: BASIC 2.0 and BASIC extension 2.1

Memory Size: \geq 832 K Byte

Interface: In addition to standard HP-IB, 2 HP-IB Interface Cards (98624A) are required.

Prober Interface

Automatic wafer probers used with the 4062A must be equipped with HP-IB capability. Hardware for mounting the switching matrix on the prober is also required. Contact the prober maker for details concerning necessary hardware.

Options

001: 12-pin System (delete 36 pins from stand. 4062A)

002: 24-pin System (delete 24 pins from stand. 4062A)

003: 36-pin System (delete 12 pins from stand. 4062A)

004: Adds 1 pin (to augment the number of pins provided by option 001, 002 and 003)

011: Extra SMU Board (for maintenance purposes)

102: Deletes 4280A

110: Deletes Test Fixtures (16066A thru 16071A)

201: Electroglas 1034X Control Software

NOTE: Refer to the 4062A data sheet for details

4062A Semiconductor Parametric Test System (does not include controller)

COMPONENT & SEMICONDUCTOR MEASUREMENT

Digital IC Tester and Digital IC Test System

Models 5045A, 5046S

- Large program library
- Test ICs to 24 pins
- Print record of IC failures
- Modify existing device programs
- Generate one-of-a-kind device programs
- Change test parameters quickly, simply

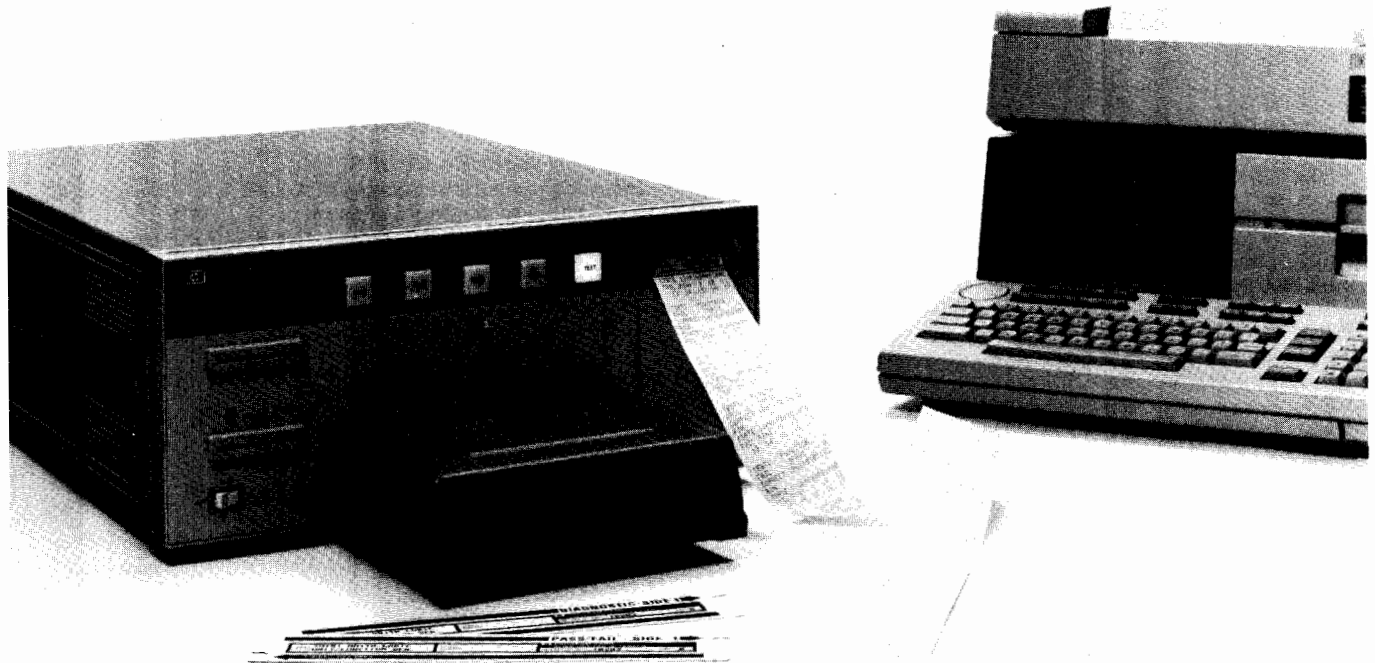

5045A Digital IC Tester

The HP 5045A Digital IC Tester is well suited for high volume incoming inspection of digital integrated circuits, simple enough to be used by an unskilled operator. To test a device, all that's required is a preprogrammed magnetic card. Insert the card into the front panel slot, and the tester is ready to provide complete dc parametric and functional verification. Test programs may be selected from an extensive list contained in our program catalog.

Permanent test results of individual IC failures are available on the standard thermal printer. Lot statistics are tabulated as testing proceeds, and are available from the printer. These are useful in documenting parts returned to manufacturers.

Test All These Families

TTL (all versions), CMOS, ECL

Universal pin electronics permit each pin of the 5045A to act as a forced voltage or current driver for inputs, outputs, open circuit, and power supplies. This provides the flexibility and capability needed to test combinatorial and sequential circuits, from gates to RAMs. Devices with power supply voltages up to 15 volts (-7.5 V to $+7.5$ V) may be tested. As testing requirements expand, your 5045A may be easily and inexpensively updated by adding new program cards. The nominal cost of these cards means that your cost-of-ownership remains low while your testing ability is kept current.

5046S Digital IC Test System

The HP 5046S Digital IC Test System is a fully programmable system consisting of the 5045A IC Tester, 9826A Controller and 2671G Printer. The System provides fast voltage and current test parameter changes with a few simple keystrokes. This ease of programming provides the ability to write or change IC test programs to meet your special testing needs. Evaluation and characterization capabilities are tailored to meet the needs of incoming QA departments as well as component evaluation.

Programming

You may apply the exact voltage and current you want for both the low and high states for any test. It's like having 24 programmable supplies available for a 24-pin IC. This capability is easily accessed using just a few lines of code. There are multiple programming methods to choose from, so you can apply just the right pattern for the device under test. You can key in all the 1's and 0's line-by-line, or write a short program block that automatically generates the device truth table. For ROMs, the system memorizes the output states of a known good device and automatically makes them part of the test program. Whether an input or output, test pattern coding is simple, direct, and provides a complete test for the device. Up to 16 separate detailed tests may be programmed to meet your exacting testing requirements.



DC Parametric and Functional Tests

The 5045A thoroughly tests devices both functionally and parametrically to ensure that defective components don't get loaded into your PC boards. Functional tests check the ability of the device to operate correctly, according to its truth table, as an appropriate input stimulus is applied. DC parametric tests check the voltage and current on devices' inputs and outputs under various conditions specified by the manufacturer. These tests eliminate almost all defective devices and avoid the expense of finding and replacing these bad circuits once they have been soldered into PC boards and perhaps become part of a complex system.

Economical ROM Testing

To test the many different truth tables which may be programmed into ROMs of the same generic type, it is not necessary to buy a card for each one. A single card containing stimulus information for the generic ROM type is loaded into the 5045A and the unique truth table of a known good ROM is "memorized" by the 5045A. The complete program is then recorded on a blank card for further use. Duplicates of any card may be made from the original by programming the 5045A, pressing "write", and then inserting a blank card. ROMs up to 64K bits may be tested.

Automatic IC Handlers

The 5045A is designed to work with automatic IC handlers needed for high volume testing. The Kelvin contacts, as well as the special circuits which generate the fast rise and fall times for testing digital circuits, are in a removable test head which can be placed within inches of the IC being tested. Problems caused by long cables between handler and tester (ringing, oscillation, slow rise/fall times) are eliminated.

HP, in cooperation with major automatic handler manufacturers, has designed custom interface kits for popular handlers. So interfacing the 5045A or 5046S and an automatic IC handler requires nothing more than plugging the two together.

Printer Gives Permanent Copy of Test Results

A built-in thermal printer provides useful test information: A) It tells whether a program is loaded correctly and what program it is. B) It records the number of failed and passed IC's. C) It provides failure analysis information for each failed IC. In its failure analysis modes, the printer provides very detailed information; a special voltage/current printout, for example. This makes the printer a digital multimeter.

Failure Statistics

Failure Statistics are valuable when making decisions on the relative acceptability of a group of devices. This information may be used as a vendor tracking tool. The 5045A and 5046S aid you in this determination by tabulating the number of devices that have PASSED and FAILED since the tester was programmed. General pass/fail statistics are available on the standard 5045A printer. Detailed lot statistics are available using the 5046S **FAILURE STATISTICS** program.

Condensed Accessories

10844B: programming interface retrofit kit; contains all necessary parts, cables, interface board, and instructions to modify the 5045A for use in the 5046S Digital IC Test System.

10845A: preprogrammed magnetic card for any device listed in the **PROGRAM CATALOG**; min. order, 10 programs.

10846A: book containing ten coupons, each redeemable for one IC program listed in the **IC PROGRAM CATALOG**. Coupons are mailed to factory, programs sent by return mail. Coupons expire after 2 years.

10847A: service kit, allows fault isolation and rapid repair of the 5045A through board replacements, thereby reducing downtime. The kit includes: all CPU boards, two pin-drivers, card reader and interface, printer interface and solenoid, front panel control, diagnostic program card kit and accessories, and carrying case.

Programming Tools

The 5046S system software is stored on one standard 9826A Disk. The programs are accessible using the special function keys on the desktop computer. The software package contains the following programs:

The **EDITOR** provides the capability to: 1) Enter IC test programs from the 9826A keyboard. 2) Read and store source programs from the 9826A disk. 3) Provide on-line editing to modify source programs.

The **COMPILER** provides the capability to: 1) Do syntax checking on source program statements. 2) Convert the source program into an object program. 3) Output the object program to the 5045A IC Tester.

The **DECOMPILER** provides the capability to: 1) Read an object program from the 5045A IC Tester. 2) Generate the corresponding source program.

The **PROGRAM ANALYZER** is used for error checking and debugging of source programs. It interrogates the 5045A processor as it executes a test program, then prints the following: 1) Listing of actual test sequence. 2) Programmed test parameters for each pin in each test. 3) The logical 1's and 0's for each pin in each test.

The **FAILURE STATISTICS** program provides the following: 1) Printout of failure by pin for each specific test failed. 2) Summary of failures and failure percentage for each test in the program.

The **FAILURE STATE MONITOR** program interacts with the 5045A while an IC is being tested. When a failure is encountered, it displays the state (vector) in which the IC failed.

The **DATA LOG** and **HISTOGRAM** programs provide detailed pin-by-pin voltage and current performance characteristics on IC devices. This provides the ability to carefully evaluate an IC's characteristics and design margins for usability in a company's products. Data is readily available on the 5046S system printer in a large, readable format.

The **STORE** and **RETRIEVE** functions provide the capability to store and retrieve up to 75 compiled programs on each floppy disk. This capability eliminates the need to load and store program cards manually for use with the 5045A.

Ordering the Preprogrammed Magnetic Cards

The 5045A is programmed by prerecorded magnetic cards available from HP. These cards, covering the most common device types, are listed in our **IC PROGRAM CATALOG (HP Pub. # 5952-7662)**. This catalog contains a wide variety of logic families and includes the majority of common device types. When additional programs are needed after the original purchase, they may be ordered through your local HP sales office or by mail with a prepaid coupon.

Condensed Specifications

Universal Pin Drivers

The same circuit drives or monitors each pin whether an input, output, power supply, clock, or open. Voltages and currents are individually programmable for each pin. No external fixtures required. **VOLTAGE** applied to the device under test:

Range	Accuracy
-7.5 V to <-1.875 V	±25 mV
-1.875 V to +1.875 V	±15 mV
>+1.875 V to +7.5 V	±25 mV

CURRENT applied to the device under test:

Range	Accuracy*
-200 mA to <-2.5 mA	±0.4 mA or ±6%
-2.5 mA to +2.5 mA	±10 μA or ±6%
>2.5 mA to 200 mA	±0.4 mA or ±6%
	*whichever is greater

Slow rate: ≥33.3 volts/μs.

Ordering Information

5045A Digital IC Tester

5046S Digital IC Test System

CIRCUIT TEST SYSTEMS

Production Testing of Electronic Printed Circuit Board Assemblies

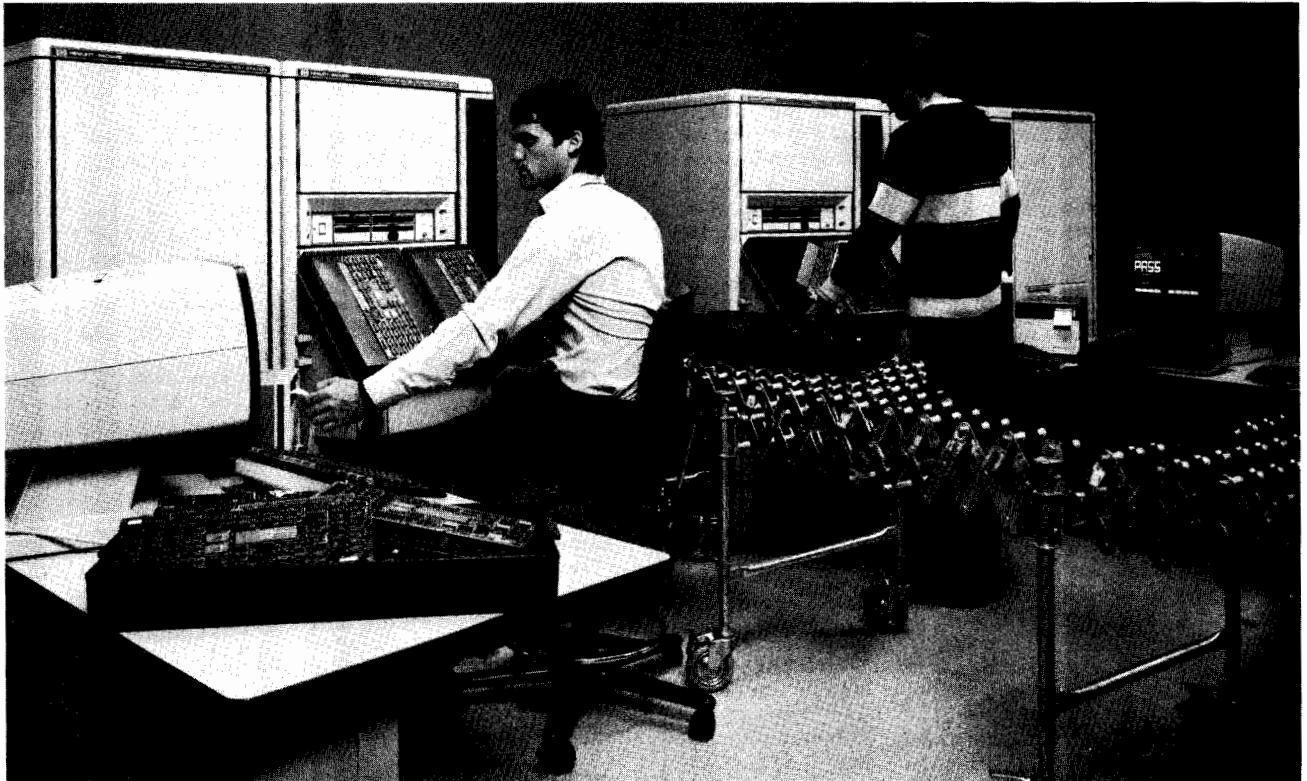

Technological advances and increased worldwide competition are placing new demands on production managers to cut costs, increase productivity and improve product quality. Automatic test equipment has become a key factor in achieving these goals. The implementation of a cost effective ATE solution requires careful assessment of the particular production environment in which it will be used.

Fault Identification

The cost of finding a fault or failure in electronic equipment increases by a factor of ten at each stage of the production process. A fault detected at board test could cost \$5—at final assembly the cost could exceed \$50. If this defective unit reached your customer, it could cost \$500 or more. While the economic costs are high, the intangible costs can be even greater. Defects at the board level could cause bottlenecks, disrupting the smooth flow of boards through production process. Failures that remain undetected until final test can lead to late deliveries and nonlinear shipments. If this same failure reached the field, it could undermine customer goodwill and your company's reputation for quality.

Since the cost of fault identification increases dramatically at each step in production, you must catch faults as early as possible. Extensive incoming inspection of parts is not necessarily the answer. Your real goal is high turn-on rates in final test. To achieve this goal requires boards that are defect free. High yield PC boards are a function of good parts and good processes.

A number of problems can occur during

the PC board assembly process that cannot be eliminated at incoming inspection. Typical problems are open traces, solder splashes, wrong or misloaded parts, poor solder joints, and parts damaged during the assembly process. If board level testing is omitted, these process faults would lead to unacceptably low turn-on rates in final test. Even with a good board yield of 60%, a simple product with only five boards would fail 90% of the time. Clearly, the best place for thorough testing is at the board level because it is the first opportunity to locate faults across the entire fault spectrum.

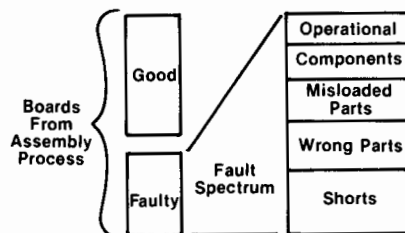

The Board Test Advantage

Automatic board test equipment will save you money by increasing productivity and improving product quality. Productivity is increased by replacing labor-intensive manual testing with computer-aided testing. Component level diagnostics provided by ATE reduces rework costs. As production through-

put increases, so does your plant capacity.

ATE will also help to achieve your quality goals. Higher quality products will lower warranty costs and preserve customer goodwill. Automatic testing provides critical feedback necessary to diagnose quality problems in your production process and correct them. This allows you to build quality into your product, not test it in.

Your production operation is unique. To determine if ATE will make sense in your application, you must compare the total cost of ownership with the savings accrued by using ATE. Return on investment calculations often show that the test equipment will pay for itself in a year or less.

Choosing a Circuit Board Tester

There are no simple answers to selecting an automatic board test system. You must consider such factors as: production yield, test yield, process induced fault spectrum, production volume, board type, and anticipated new products. If ATE makes sense, you must then consider the level of support you will receive from the ATE vendor.

Three general types of loaded board testers are presently being used in the electronics industry. They are in-circuit, functional and combination in-circuit/functional testers. The in-circuit test system locates faults by checking components and circuitry without energizing the entire board. Functional testers isolate faults by exercising the board in a manner that simulates its use in the final product. Combinational testers perform in-circuit evaluation before powering the board for functional testing.



In-circuit Board Testers

In-circuit testers access all nodes on the PC board through a bed-of-nails fixture. Spring loaded pins contact the internal points on the loaded board. Components can be isolated using an electrical guarding technique and then tested for value, placement, and component type. In-circuit testers are well suited for detecting manufacturing and workmanship-related faults which can account for up to 80% of all faults.

Program generation on an in-circuit tester is simple and straightforward. Most of these test systems have automatic program generators that automatically develop the in-circuit portion of the test plan. Since the tests are component level only, the actual function of the PC board is irrelevant. The tester steps through the test plan from component to component and evaluates specific characteristics of each device. This technique provides excellent diagnostic resolution at the component level.

Functional Board Testers

Functional test systems emulate the electrical environment of the board under test. Stimulus sources act as input signals to the circuit, while detectors measure the output and compare it with the expected response. The primary goal of the functional test system is to verify the dynamic performance of the complete circuit under test. Most dedicated functional test systems are stimulator-based and provide a fast go/no go indication on the board under test. Since all tests are performed at the board-edge connector, fault isolation is more difficult and time consuming than with the bed-of-nails fixture used for in-circuit testing.

Combinational Test Systems

Individually, in-circuit and functional testers have advantages and disadvantages. Combining these measurement techniques provides a complementary approach to board testing. The spectrum of faults not covered by in-circuit testing is usually covered by functional test capability.

Advances in test technology have led to the development of test systems that perform both in-circuit and functional testing. They combine the best of both techniques into a single system. Test systems that blend in-circuit and functional test capability can not only check for shorts and component errors, but can also verify the dynamic performance of the circuit under test.

These combined test systems are ideal for boards that have nodes that can be accessed with a bed-of-nails fixture, whether analog, digital or hybrid. Test capabilities of these systems can include analog in-circuit, analog functional, digital in-circuit, digital functional, and shorts testing.

Advanced Analog In-circuit Testing

All HP in-circuit testers use advanced techniques that allow component isolation in even the most difficult circuit configurations. For example, a 0.01 μF capacitor can be measured to an accuracy of 4% even when in parallel with a 1000 ohm resistor. This is made possible by our 6-wire guarding and phase synchronous detection. Added features such as remote sensing, extended guarding, and extra digit greatly expand the precision measurement capabilities of HP's board test systems.

Extended Guarding

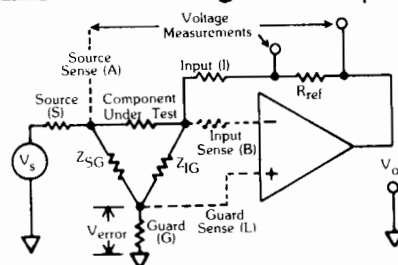

Analog Functional Testing

Functional testing enhances in-circuit test results and can significantly increase board test system yields. Each HP board test system with in-circuit capability also has standard sources and detectors to provide functional testing. Optional instrumentation can easily be added via the HP-IB interface. Active analog functional testing finds faults not detected with in-circuit testing and allows tuning and circuit adjustments by system operators.

Digital In-circuit Testing

Digital in-circuit testing electrically isolates each IC on the board while it is tested. This technique requires that the test system take control of the chip's inputs by overdriving the outputs of "upstream" devices. Overdriving without careful analysis of these digital tests can potentially cause failure during testing or latent failures due to device degradation.

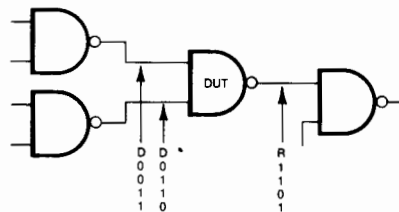

After over three years research, HP determined that to minimize the potential for device damage, each individual IC test should be analyzed. This is due to the variety of configurations in which a device can be used. HP's "Safeguard In-circuit" analysis software looks at each test as it is created. It considers device parameters such as package type, power dissipation, and overdrive voltages and currents to minimize the damage potential. To further reduce the potential for device damage, two driver edge speeds are available to reduce voltage overshoot. If the chance of excessive temperature rise exists, a cooldown time is automatically imposed. After all these precautions are taken, if the potential for damage still exists, the programmer receives a warning message.

Digital Functional Testing

There are basically two forms of digital functional testing: high speed digital functional testing and static pattern testing. HSDFT tests the circuit "at speed", emulating the dynamic operation of the circuit under test. Signature Analysis is an HSDFT test method consisting of a high speed digital stimulus and a synchronous measurement technique. Long data strings are compressed into a four character hexadecimal string called a signature. These DUT signatures are

then compared to those learned from a known good board.

Static pattern testing consists of applying a test pattern at the input of a printed circuit board and measuring the response at the output. If the tester has access to internal circuit nodes, the output of each individual device can be tested.

SIGNATURE ANALYSIS

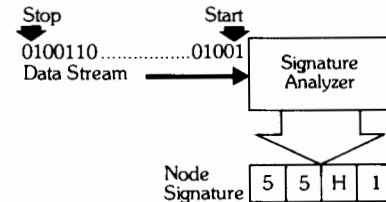

Test systems can access the board under test in several ways. The first is via the board-edge connector. Used primarily with the static pattern test technique, this method gives a fast go/no go indication for the circuit under test. Component level fault isolation, if available, is usually through the use of a program-directed probing technique. A second method uses a bed-of-nails fixture to access every circuit node, providing simple component level diagnostics. The same is true for the combined edge connector/bed-of-nails fixturing method.

Test patterns for functional test systems can be generated manually or by a simulator. Manual generation is usually limited to simple circuits. The output of computer aided design (CAD) systems can be used to simplify the manual process. The two basic types of simulators used to generate functional test patterns are those that are an integral part of the functional tester and the off-line simulator. Simulator outputs are generally required for comprehensive testing of large, complex digital circuits.

HP's Testing Techniques

Since each production process is unique, your specific process may require several of the measurement capabilities listed above. HP's Circuit Test product line offers a wide range of board test systems, each providing at least two of these testing techniques. Analog in-circuit and functional testing capabilities are available in the 3061A, 3062A and 3065H board test systems. The 3062A provides static pattern and high speed digital functional testing. Digital in-circuit testing with "Safeguard In-circuit" analysis is provided on both the 3065D and 3065H. The DTS-70 is a simulator-based digital functional tester with analog functional testing capability.

Is ATE The Answer?

Can automatic board test equipment save you money? Again, there are no simple answers. Chances are that it can if any of the following conditions exist in your plant: high PC volume, complex boards, backlogs in production test, low turn-on in final assembly, high in-process inventory and high warranty costs. Our field engineers can help you characterize your production operation by comparing the cost of testing, or not testing, at each level of the process. They are available to help you answer your ATE questions.

CIRCUIT TEST SYSTEMS

In-Circuit/Functional Test Systems

Model 3061A/3062A



Description

Two new board testers, the HP 3061A and 3062A, have been added to Hewlett-Packard's expanding line of circuit test systems. These test systems combine excellent in-circuit fault isolation with functional testing capability to maximize PC board yields. Both the 3061A and 3062A incorporate advanced measurement and interface technology based on years of experience within HP and field proven in the HP 3060A.

The HP 3061A Board Test System has been optimized for analog PC board testing. It combines advanced analog in-circuit and analog functional test capabilities with high speed shorts/opens testing.

The HP 3062A Board Test System adds both digital static and digital functional testing to analog testing capabilities of the HP 3061A. You can choose the system that is right for your specific production test needs.

Selecting a Board Tester

Which quality problem does your board test area encounter most often? Is it workmanship? Shorted or open circuits? Failed components? Misloaded components? Functional failures? Hewlett-Packard board test systems are designed to solve the problems of shorts/opens, component or functional failures. High test yields mean lower test and repair costs.

HP board test software minimizes your test development investment. Using the program development tools decreases the time required to generate board test programs. The software is also structured so programmers can develop board test programs on programming stations anywhere in your facility. 'Off-line' programming stations allow programmers to develop programs without affecting production flow.

System Controllers

A board test system controller must offer your programmers high-level software and a user interface which is friendly and flexible for production testing. HP selected its own Series 200 Desktop Computers for this important function. The Series 200 Computers are the

result of more than 10 years of system controller design experience. They offer advanced edit features for programming efficiency and simple system expansion via the flexible I/O structure. With the power of the Series 200 controller, your programmers will be able to write effective board test programs.

You may select from three system controllers, the Model 36, Model 26, or Model 16. Software written on one model is directly compatible with the others. The Model 26 and 36 computers have built-in floppy disc drives for convenient programming. Additional hard disc drives can be added. The Model 16's low cost and small physical size makes it an ideal controller for dedicated test applications.

Advanced Analog In-circuit Testing

The HP 3061A/3062A advanced analog in-circuit testing finds faults over a wide variety of components, measurement values, and tolerances. Advanced six-wire guarding methods make accurate measurements possible, even in cases of severe parallel shunting. (HP pioneered this technique in the mid 70's.) Programmers may select a variety of guarding methods to optimize throughput and accuracy for specific production requirements.

This test technique assures you of consistent measurement results from board-to-board and between systems. For example, you can off-load analog testing from one tester to another during peak production periods and get the same test results. HP analog in-circuit testing techniques mean flexible, consistent, and accurate measurements from your testers.

Analog Functional Testing for Higher Yields

Analog functional testing enhances the results of in-circuit testing and significantly increases PC board yields. Yields of 85-90% using analog in-circuit test methods may be increased to 95-98% with the addition of functional testing. The standard HP 3061A/3062A gives the user a wide range of measurement test tools for full functional testing. If additional functional test capability is required, HP-IB instrumentation from Hewlett-Packard may be easily added for your specific functional test needs.

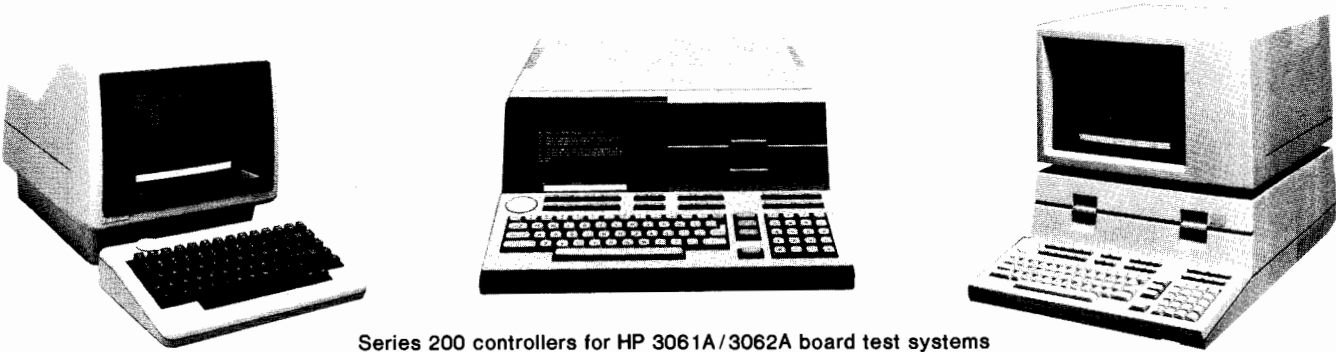

Series 200 controllers for HP 3061A/3062A board test systems

Digital Functional Testing

The HP 3062A tests digital PC boards containing a wide range of logic devices including microprocessors. The testing of microprocessor-based circuits with bus-structured devices, large memories, and dynamic memory devices often presents difficult test problems. Functional testing of your microprocessor boards is reduced to a manageable task using Signature Analysis (SA).

Digital Static Pattern Testing tests circuits of medium complexity. This technique stimulates digital circuits and compares the measured response to an expected response. Using advanced analog testing and static pattern testing, hybrid circuits such as A to D's and phase lock loops can be thoroughly tested.

Software For Your Programmers

Your programmer will reduce test development times through the use of HP's high-level languages and automatic program generator. The system software includes Board Test Language (BTL200), In-circuit Program Generator (IPG200), Digital Functional Test Development Package (DFT200), Data Logging routines and Fixture Verification programs.

The system Board Test Language (BTL200) controls complex system functions. These functions include setup, measurement, response, and data evaluation. It is structured to work efficiently with the system hardware, reducing the amount of time it takes to execute a test. Your programmer needs to know only simple high-level component test statements to write a program.

Using on-line editing and immediate execution capabilities, various test configurations can be quickly evaluated. With BTL200's high-level statements, your programmer can write board test programs which will increase throughput on your production line.

IPG200 automatically generates the analog in-circuit test program. Your programmer needs to enter only the circuit description with component values and test tolerances. IPG200 will automatically analyze parallel paths and select optimum guarding locations. When the program is complete, a measurement analysis of each component, the test program, and fixture documentation is printed out. Using the final test program and fixture documentation, your programmer can begin building the test fixture. Fixture verification software will help check fixture construction for errors.

The DFT200 software development package aids the user in entering and debugging programs using the Signature Analysis (SA) technique. DFT200 combines stimulus and SA measurement routines into a final efficient test program. This means faster program execution and high PC board throughput.

Systems Designed For Your Changing Needs

The dynamic nature of the electronics industry requires the selection of a flexible board test system for your production area. HP board test systems, with their standard HP-IB capability and modu-

lar design concept, give you the necessary flexibility. As your testing requirements expand, additional measurement capability can be added to the basic system to increase the test capability.

Production Test Strategy

ATE is used in all areas of the manufacturing process to reduce production costs. You may think of other reasons for buying ATE, but the bottom line is lower production costs, higher yields, and increased productivity for your production area.

There are many steps in the production process where testing may be done. When and how to test depends on factors such as PC board volume and complexity, production yield, and the desired level of fault isolation. Based on actual testing reports, it's easier to find faults at the PC board level than anywhere else in the production process. This makes a strong case for concentrating the testing effort at the PC Board level.

Quality Through Data Analysis

Board test systems find faults and give you the opportunity to repair them before they reach customers. But is finding a fault and repairing it the ultimate goal for your board test area? The use of statistical methods to analyze recorded failure data and eliminate problems in your manufacturing process is the real key to increasing productivity.

HP 3061A/3062A Test Systems accumulate data required for statistical evaluations of your production process. HP-supplied programs can analyze the data or you can write your own data analysis programs easily using HPL statements. Analysis of your failure information will isolate problems in your manufacturing process.

HP Support

Qualified systems engineers are located near your facility to provide you with applications and programming support. Customer Engineers support your system on a worldwide basis through the use of locally-placed system service kits. But, that's still not the whole story. Complete user training courses are taught for each system. To enhance the learning process, these training courses are offered at 14 Hewlett-Packard training locations throughout the world.

Installation

HP will install your system and verify proper operation to insure that you have a quick start-up.

Documentation

HP board test systems are supplied with complete documentation. This documentation is used for training, future applications and service reference.

Ordering Information

3061A Board Test System
(depending on configuration)

3062A Board Test System
(depending on configuration)



- High throughput
- Low programming costs

- Multiple test stations
- Multiple programming stations

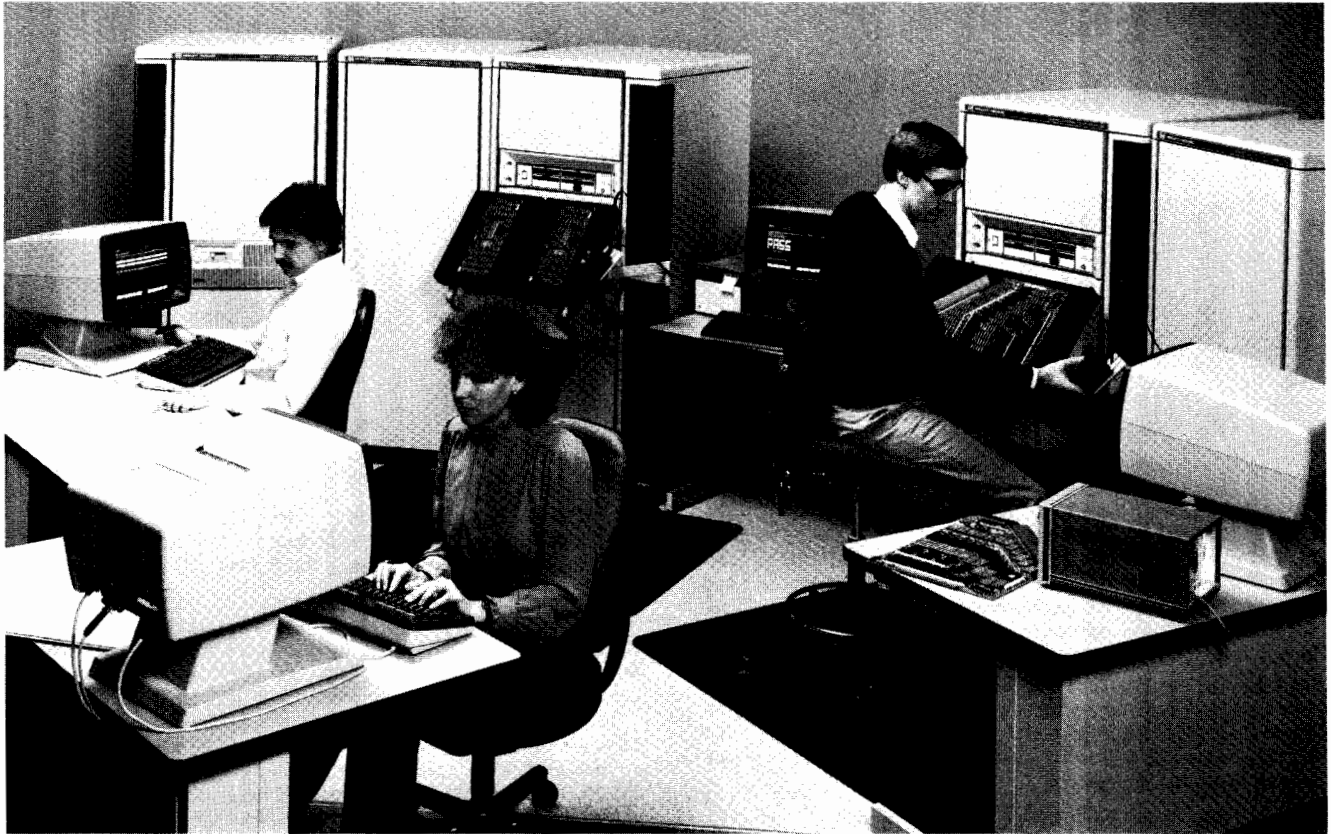

Description

The HP 3065 Board Test Family is the result of years of experience in automatic testing and advanced computer technology. It combines high speed digital in-circuit testing with our proven 6-wire analog in-circuit and analog functional measurement capabilities. In addition, the 3065's distributed intelligence architecture allows a single system controller to support multiple test stations, multiple programming stations and a variety of peripherals without sacrificing high throughput in production test.

The 3065's family concept and modular design allows configurations to meet today's testing requirements and still provides flexibility for future expansion. A basic 3065 test system consists of a system controller and a test station which includes an equipment bay, a measurement bay and a work station with terminal and strip printer.

System Controller

The 3065C System Controller includes a high speed minicomputer that serves as a test station controller for production testing and a test development center for program generation. It is configured exclusively for the board test environment, requiring the user to interact only with the board test software, not with the computer's operating system.

A single 3065 controller supports up to three test stations plus three programming stations simultaneously. If less than three test stations are required, programming stations may be added. The 3065C can be used exclusively for a test development center, supporting a total of six programming stations.

Digital Test Station

The 3065D Digital Test Station provides digital in-circuit testing to isolate component and process induced faults on digital boards. As part of a distributed control structure, the test station uses a bit-slice computer as a local controller and RAM-behind-the-pins to apply complex pattern sequences to test SSI, MSI and LSI/VLSI devices. Pattern application rates are programmable up to 2.5 MHz on all

pins. The 3065D's 1056 digital node capacity allows it to test large digital boards with over 200 IC's.

Advanced testing techniques provide shorts testing at greater than 200 nodes per second. Failure messages report all common devices connected to the failing node to speed repair. The digital in-circuit testing uses the 3065 device library of over 2200 part numbers to decrease digital test development times. The in-circuit program generator, IPG-II, automatically modifies each library test to match the topology of the device on the board. Custom IC tests are easily generated using the high level Vector Control Language of the 3065 system.

Analog/Digital Test Station

The 3065H Analog/Digital Test Station expands the capability of the 3065D to include analog in-circuit and functional testing. It can be configured with up to 1056 digital nodes or up to 1408 analog nodes for testing large analog, digital or hybrid boards. Analog in-circuit provides 6-wire guarding, phase synchronous detection as well as enhanced and extra digit measurement modes for measuring a wide range of components and component values. Analog functional measurements can be made with internal sources and detectors or a variety of external instrumentation via the HP-IB interface. Functional tests are programmed by simple BT BASIC commands.

Throughput

Digital throughput is usually incorrectly equated to test pattern application rates. In reality, actual test times are a very small portion of the total time required to test a digital device. With test vectors being applied at MHz rates, it takes less than 50 microseconds for most IC tests. Conventional testers incur overhead times of 50 to 750 milliseconds reading data from the disc, downloading test data to the hardware, reading the received data, and comparing the results with the expected pattern. In most cases, overhead varies with IC complexity. The 3065's digital throughput of 30-45 IC's per second is virtually independent of device complexity.

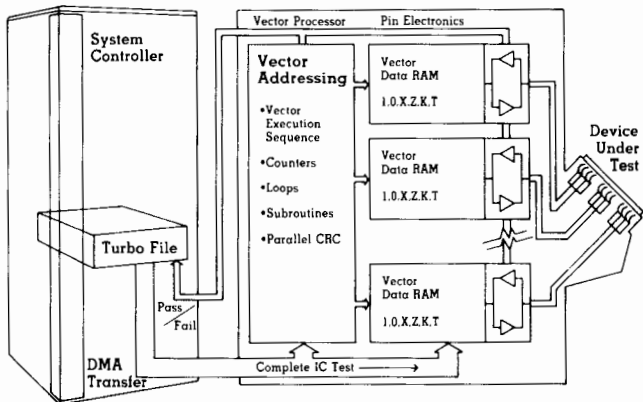

The 3065's architecture downloads an entire digital test from the system controller to the test station electronics in one DMA transfer. A Vector Processor microcomputer in each 3065D/H test station sequences test vectors stored in the RAM behind the pins.

Distributed Intelligence Architecture

The 3065 uses efficient software and a distributed intelligence hardware design to minimize overhead times. Each test station has its own bit-slice microcomputer, the Vector Processor, plus RAM and control electronics to provide MHz test vector rates on all digital pins.

The HP 3065C System Controller reads multiple device tests into a "turbo" file in its memory during a single disc access. Then using Direct Memory Access (DMA), the system controller downloads complete device tests from the "turbo" file to the test station one at a time. Test sequence information is loaded into the Vector Processor memory and unique test vectors are loaded into the RAM behind the pins.

Vector Processor

The Vector Processor controls the real-time digital test execution for each test station. Using a pipeline architecture, the Vector Processor eliminates overhead time between test vector applications. As tests are executed, pin electronics supporting each test pin makes a pass/fail decision in hardware by comparing the received data with the expected pattern. The instant a failure is detected, a fail bit is returned to the Vector Processor. The system controller detects this failure and immediately initiates the DMA transfer of the next complete device test.

Pin Electronics

Each bi-directional test pin is supported by local RAM. This RAM is used to store only unique test vectors required to test a device. Each of these vectors may be applied as many times as necessary by the Vector Processor to completely test the DUT. The RAM also supports the 3065's K (keep the previous state) and T (toggle the previous state) vector states in addition to the traditional 1, 0, X and Z. This derivative mode and the unique vector storage give the 3065 an equivalent of 4k random vector storage and almost unlimited algorithmic vector capability. Using these techniques, data compression of 150:1 and greater can be achieved.

By reducing the amount of data that must be transferred and minimizing or eliminating overhead times inherent in the test process, the typical 3065 overhead time averages less than 30 milliseconds. This gives the 3065 a digital throughput rate of 30-45 IC's per second.

Lower Test Development Costs

Test development costs can be the major on-going cost of owning a board test system. The 3065 helps control these costs by providing a unique software environment to increase programmer productivity and reduce test development costs. From data entry to test execution, the 3065 is easy to use.

Automatic Program Generation

Since Computer Aided Design (CAD) systems often contain board topology information, the 3065 can link to these systems to retrieve

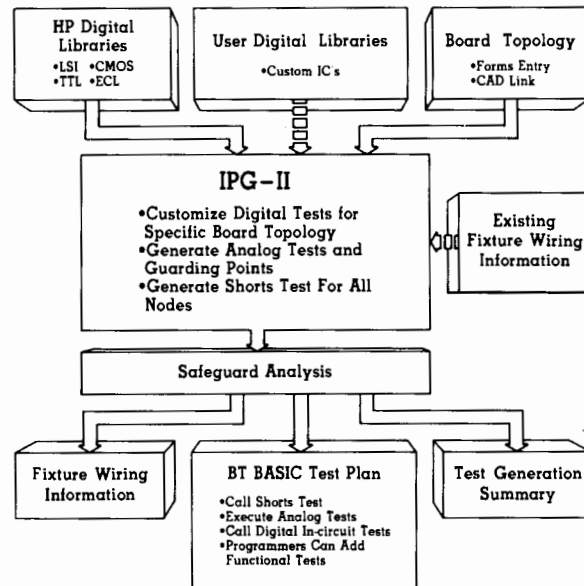

IPG-II is HP's second generation in-circuit program generator. Requiring only a board topology as input, IPG-II uses digital libraries and the circuit description to generate the entire in-circuit test plan.

this data. Non-technical personnel can add to CAD data using the 3065 forms entry package. If CAD system data is not available, the entire circuit description can be entered easily into the fill-in-the-blank forms package.

Once the circuit description is entered, the 3065's In-circuit Program Generator (IPG-II) creates an in-circuit test plan for all analog and digital components—automatically. Tests for all analog components are automatically generated, including guarding required to eliminate the effects of the surrounding circuitry. Digital IC tests are selected from the 3065's library of more than 2200 part numbers and automatically modified to reflect specific applications of digital devices on the board under test.

IPG-II easily accommodates engineering changes after the board is in production. In addition to entering the production changes, the existing fixture wiring information can be entered. IPG-II will use this data to produce a new wirelist to minimize fixture rewiring.

The outputs of IPG-II are fixture wiring information and a test plan that calls the shorts tests, executes the analog test, and calls the digital IC tests. A test generation summary is also provided. On a digital board with over 200 IC's and 100 analog components, IPG-II produced a test plan with 90% working tests without debug. This translates to faster test turn-on and lower test costs.

Screen Editing

The 3065's screen editor is patterned after word processor systems and is interactive and user friendly. Information displayed on the screen is the actual content of the file, eliminating the need for system users to learn a large number of display commands. Dedicated editing keys on the terminal keyboard provide screen scrolling and character or line insertion and deletion. High-level commands such as "find", "move" and "change" simplify the editing of files.

The 3065 provides line-by-line syntax checking. Any attempt to enter incorrect syntax produces a self-explanatory error message to the screen. A blinking cursor indicates the position of the error to speed error correction.

Softkeys support each phase of test development and allow users to execute the most commonly used functions rapidly. These keys are automatically programmed by the system and displayed on the CRT screen. These softkeys provide such functions as command recall, fixture control and data entry throughout the test development process.

CIRCUIT TEST SYSTEMS

Board Test Family

Model 3065 (cont.)

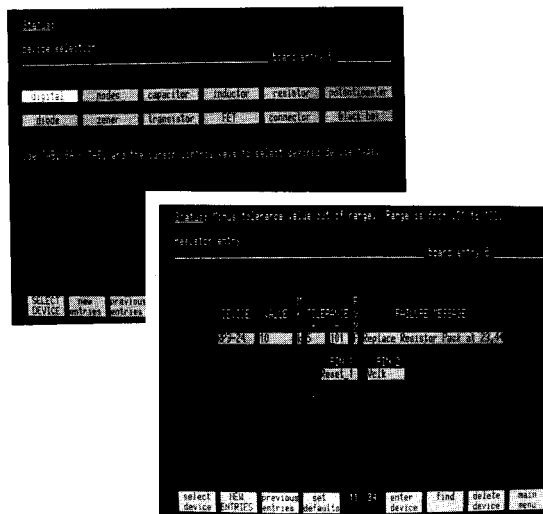

With fill-in-the-blank forms and softkey command execution, the 3065 simplifies user interaction for fast test turn-on. All entries are checked for correct syntax before they are accepted by the system. Syntax errors are written to the screen in an easily readable format.

System Programming Languages

The HP 3065 system uses Board Test BASIC, consisting of familiar BASIC commands with additional high-level statements to simplify test development and modification. Because it is BASIC, users rapidly grasp the fundamental concepts of the language and can concentrate on advanced programming techniques. In-circuit tests are written in BT BASIC and test components with a single command. The system does the actual programming of the hardware, relieving programmers of having to learn cryptic programming codes. The programmer still has the option of optimizing the test for a particular component. Built-in features such as long variable names, conversion routines, looping and subroutines make the programmer's task much easier.

Custom IC tests are developed using the 3065 Vector Control Language (VCL). VCL provides powerful tools for developing proprietary device tests, or for custom devices not in the digital library. The language is flexible yet friendly, with screen editing and syntax checking built in. Since the standard library tests are written in VCL and are self-documenting, they can be used as examples when programming custom devices. All features such as counters, subroutines and parallel CRC are available to the programmer as well.

"Safeguard In-circuit" Analysis

Digital in-circuit testing electrically isolates a device on a PC board while it is being tested. This technique requires that the test system takes control of the chip's inputs by overdriving the outputs of "upstream" devices. Overdriving these devices without careful analysis can potentially cause device damage or degradation. HP spent three years researching the causes of device damage and found the major causes to be overdrive current, excess temperature rise and voltage overshoot. It was determined that the circuit configuration as well as the device parameters contribute to potential IC damage.

HP's "Safeguard In-circuit" analysis package automatically evaluates all digital tests to minimize the potential for device damage or degradation. The analysis considers device parameters such as package type, device family, power dissipation, and voltage/current handling capabilities as well as circuit topology. It then selects minimum levels necessary to overdrive logic states, yet maintain adequate noise

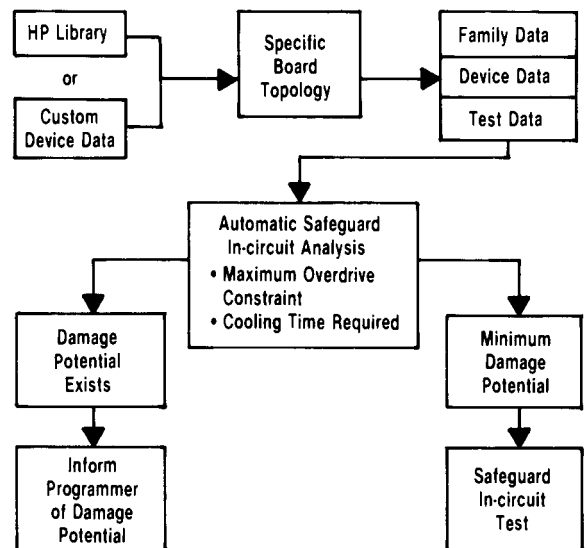

The 3065's Safeguard In-circuit analysis package automatically evaluates each digital test as it is created. Whenever the potential for damage is identified, the programmer is notified and test execution is prohibited.

margins. It also selects the appropriate edge speed to minimize overshoot; fast edge for fast TTL and ECL logic families, slow edge for CMOS to prevent latchup.

If cumulative heating is a problem, "Safeguard In-circuit" imposes a cooldown time between tests. This is particularly important during debug since it may be necessary to loop on a test or series of tests. The cooldown period occurs during the overhead time, therefore it has minimal effect on digital throughput.

MPN/Networking

HP brings the Manufacturer's Productivity Network into your test department. With its multi-link networking capability, the 3065 can become an integral part of your facility networking plans. That means it can communicate with other automatic test systems or with CAD/CAM and management systems.

Using the 3065's networking capability within the test department, all test programs can be stored in a master file for use by several test systems. Multiple test systems, connected via the network, can share resources such as printers and discs, greatly reducing equipment costs. The 3065 can also link to HP desktop computers, HP 1000 and 3000 computer systems, or to non-HP computers. Software required for networking the 3065 to these systems is a part of the standard software package. Datalogging, failure analysis, and timely management reporting via the MPN provides maximum control of the production process.

Support

HP offers a complete solution to your application, hardware and software support needs. Application software services are available to get you up and running fast or help out during peak load periods. This is the fastest way to get your test system into productive use. Preventive maintenance and periodic adjustments will keep it operating at peak efficiency.

Our software support services give your programmers the most current revision of the 3065 software and can provide worldwide programming assistance when needed. HP can help design a support package that best meets your specific requirements.

3065 Board Test Family

Price depends on system configuration



Fixturing Products



Description

The new vacuum-actuated test fixtures have a dual vacuum plate design that creates a guided probe system. The spring probes are equipped to allow wire-wrap interconnections, and are easily replaceable. A patch panel interfaces the probes to HP 306X Board Test Systems' relay matrix. The entire lightweight fixture is enclosed by a molded plastic case, eliminating the possibility of accidental damage or contamination. An optional extender with breadboard allows you to add your own custom test circuitry to the fixture.

Performance

Special attention has been paid to the design of the new fixturing products to ensure performance. The patch panel is made of a material that exhibits very high isolation resistance. This means leakage currents are kept low and will not significantly affect in-circuit measurements. In addition, the spring probes exhibit low series resistance and can handle up to three amperes of current.

Attention has been paid not only to electrical performance but to mechanical performance as well. For example, the fixture has been designed to significantly reduce vacuum requirements. Low leakage probe sockets together with an improved vacuum seal made of durable thermoplastic rubber help achieve an air-tight construction. The improved vacuum seal serves to muffle the acoustic noise level for smooth, quiet operation.

The fixture kits are designed for ease of assembly and modification. No adhesives are required at any point in the assembly process. The test head is hinged and can be locked in either the down position or the up position for easy access to wiring. Once assembly is completed, a fixture verification software package aids you in debugging the initial construction and is also useful for repairing and troubleshooting the kits already in production.

Test Fixture Available in Three Sizes

There is a kit for relatively small boards up to a size of 25.4 x 33 cm (10" x 13"). For larger boards, a kit that will accommodate sizes up to 33 x 55.9 cm (13" x 22") is available. In addition, a dual fixture kit is also available which allows you to increase your throughput by testing boards in tandem. Each side of the dual fixture will accept a small size PC board. All three of the fixturing products are fully compatible with HP 306X Board Test Systems, and are available as either options or accessories.

Fixture Construction Kit Parts

Probes

Three probe styles are available, each with two different ranges of spring tension. The probes can be ordered with sixty degree single-point tip (opt 005 and 007), star or crown-point tip (opt 012 and 013), or a serrated multi-point tip (opt 006 and 008). The high force (8 oz.

spring tension) probes are recommended except for high pin density applications. In these applications, low force (4 oz. spring tension) probes should be used. Each option contains 100 probes.

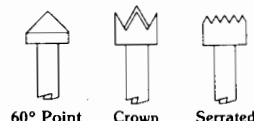

Sockets

HP sockets (opt 009) are specially designed for low air leakage and reliability. The sockets have 0.6 mm (0.025") diameter wire-wrap® posts. Each option contains 100 sockets.

Patch Panel Plugs

Six patch panel plugs are available to meet your specific fixture building needs. Single (opt 010 and 014) and dual plug (opt 015 and 011) versions are available pre-wired and with wire-wrap® posts only. The pre-wired 5-plug (opt 018) is used for 3065 systems digital nodes. It features twisted pair wires for quick and easy wiring of 4 digital nodes. Option 017 DUT PWR Pin plugs are required for 3065 digital pulser power requirements. These plugs are specially designed to fit the 3065 system scanner board.

Extenders

Height extenders are available for the standard fixture (opt 001) and for the large or dual fixture (opt 002). These extenders add 7.6 cm (3") of vertical height. A 12.7 cm x 17.8 cm (5" x 7") breadboard is supplied with each extender.

Assembly tool kit—option 003 contains the hardware and tools needed to assemble HP test fixtures. One tool kit is needed for each assembly station.

Spare parts kit—option 004 contains spare parts for constructing or modifying an HP test fixture.

Options

- 001: Standard Extender
- 002: Large/Dual Extender
- 003: Assembly Tool Kit
- 004: Spare Parts List
- 005: LF Single-Point Probes, 100 ea.
- 006: LF Multi-Point Probes, 100 ea.
- 007: HF Single-Point Probes, 100 ea.
- 008: HF Multi-Point Probes, 100 ea.
- 009: Probe Sockets, 100 ea.
- 010: Single Patch Panel Plug, 100 ea.
- 011: Dual Patch Panel Plug, 100 ea.
- 012: LF Star-Point Probe, 100 ea.
- 013: HF Star-Point Probe, 100 ea.
- 014: Pre-wired Single Patch Panel Plug, 100 ea.
- 015: Pre-wired Dual Patch Panel Plug, 100 ea.
- 017: DUT PWR Pin Kit, 18 ea.
- 018: Pre-wired DR/RV 5-Plug, 50 ea.

Ordering Information

- 44538A - Small Kit
- 44539A - Large Kit
- 44540A - Dual Kit
- 44541A - Construction Kit Parts

CIRCUIT TEST SYSTEMS

Digital PC Board Test System

Model DTS-70

- High speed, high volume digital testing
- Isolate faults quickly and easily
- Eliminate production bottlenecks

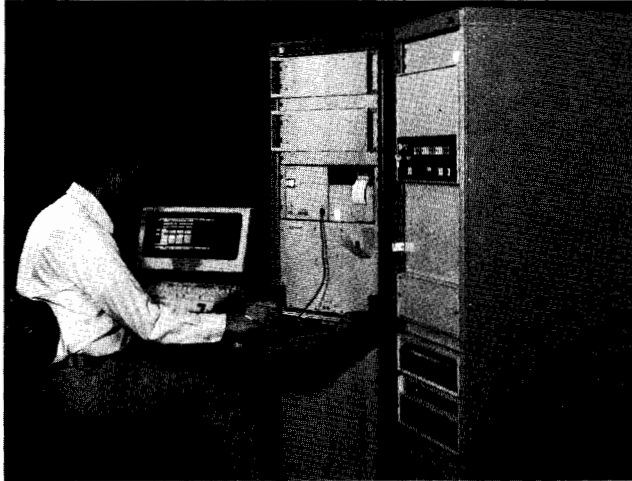

Description

The DTS-70 Digital Printed Circuit Board Test System can solve your digital board testing needs. The DTS-70 can test your boards and isolate faulty components in seconds. Typical tests take only a few seconds and isolation of the failed component typically takes less than a minute. All this testing is performed to a known level of test effectiveness. The TESTAID board simulation software, provided with the system, enables you to determine the overall effectiveness of your testing process, a benefit not possible on hardware comparison testers. The FASTRACE fault isolation software guides your test operator to probe for the faulty component quickly and easily, all but eliminating costly manual troubleshooting.

The DTS-70 System is a complete system consisting of the 9571A Test Station, the HP System 1000 computer and a complete software package. The 9571A Test Station comes complete with digital test unit, programmable power for your board under test, and fault isolation probe. The test station is expandable to do added analog testing that may be required. The field proven HP System 1000 includes the 21MX Series E computer and 7906A disk. The HP System 1000 provides both testing and software test generation expandability through the Real Time Executive operating system. The TESTAID simulator software and FASTRACE fault isolation software provide powerful test generation capability and advanced fault isolation which even enables you to isolate intermittent faults.

The DTS-70 is a test system with the capability, expandability, and reliability you expect from HP.

No More Production Down-Time to Develop Test Programs

The multi-terminal capability of the DTS-70 allows you to generate test programs without shutting down testing on your production line. No longer do you have to choose between production shut downs and spending tens of thousands of dollars for off-line test generation capability. All you need is a relatively inexpensive terminal. Need more programming capability to keep up with new boards? Add up to six terminals to the DTS-70 for use as programming stations.

High Speed, High Volume Digital Testing

Test complex boards in only seconds compared to the minutes or even hours necessary for manual test and fault isolation. The DTS-70 is capable of testing tens of thousands of PC assemblies a month for high throughput requirements.

Isolate Faults Quickly and Easily

Troubleshooting and isolation of faulty components is done automatically. The computer instructs your test operator to isolate the fault in seconds using the guided probe. Avoid time-consuming manual fault diagnosis and reduce the need for highly skilled technicians.

Eliminate Production Bottlenecks

The DTS-70 can test those complex boards that are so hard to troubleshoot at your final product test station and which hold up your shipments. The DTS-70 is capable of testing complex boards with over 200 MSI components.

How Effective is Your Test?

Only a simulator-based tester such as the DTS-70 can tell you how effective your tests are. The DTS-70 not only tells you how effective your test is, but also which nodes on the board need further attention. This has improved test quality over manual functional test generation methods by factors of two or more.

Model Your Designs in R & D

Catch costly design and testability problems before they become designed-in problems. The DTS-70 TESTAID simulator software models the behavior of your designs, points out testing trouble spots, and predicts race and hazard conditions to your designers. Simulation at the design stage can prevent marginal designs and designed-in problems from reaching your end-users, preventing high warranty costs or costly on-site repairs.

Worldwide Support

The DTS-70 Digital Test System is designed and manufactured by Hewlett-Packard and is backed up by HP worldwide support. HP recognizes that in a high volume production environment, each hour of operation affects a large portion of your profit dollars. When you take delivery of a DTS-70 system, the following support is available to you, worldwide, to keep your system working for you.

Installation

Installation services will be provided with each purchase of a DTS-70 Test System. These services consist of site preparation data in advance of system delivery and installation when your system arrives.

Warranty

A complete warranty program covers the entire DTS-70 system for 90 days beyond the system installation date. This warranty provides complete repair service during the warranty period.

Customer Assistance Agreements

For system support beyond the warranty period, Customer Assistance Agreements are offered for hardware support and software support. You may select these services together or you may tailor a service program to match your individual needs. With the exception of extremely remote areas, these support programs are available throughout HP's worldwide service organization.

Training

A digital test programming course is included for customer personnel responsible for developing test programs. This 10-day course teaches system operation, FASTRACE fault isolation and emphasizes use of TESTAID to generate digital test programs. Two enrollments are provided with the purchase of a DTS-70 system.

Documentation

Every DTS-70 System is delivered with a complete set of operating and service documentation. The documentation set includes system level manuals, instrument level manuals, software manuals and quick reference guides.

Field Support Package

For those DTS-70 users who choose to do their own servicing, HP offers special field support packages in the form of service kits that contain replacements assemblies. These service kits are designed to allow a user to support his DTS-70 system. For more information on these field support packages, contact your local HP field engineer.

Ordering Information

DTS-70
(Depends Upon Test Configuration)

DIGITAL CIRCUIT TESTERS

Logic Troubleshooting System

Model 55005S

141



- Automated digital troubleshooting using signature analysis
- Automatic test construction and documentation generation
- Backtrace and signature matching troubleshooting modes
- No programming or device libraries required

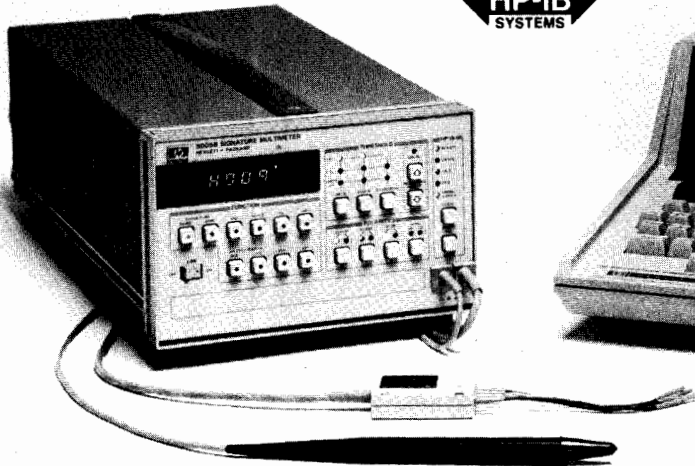

55005S Logic Troubleshooting System

Description

The 55005S Logic Troubleshooting System represents a significant advance in automated digital test construction, documentation, and directed troubleshooting using Signature Analysis. It consists of an HP 85 Computer, 5005B Signature Multimeter, system software, optional flexible disc drive, and optional printer. These components together provide a significant productivity improvement when applied to troubleshooting digital products.

Test Construction

Circuit characterization is greatly simplified by the 55005S's LEARN mode. All information necessary for troubleshooting a product is generated during the signature collection phase of LEARN mode. The operator only needs to know the device number, input/output status of each device pin, and the circuit connection points. Automatic signature collection, through the 5005B Signature Multimeter, and directed softkey inputs provide the data required to build a troubleshooting data base. This eliminates the requirement for device libraries or special programming.

Test construction utilizes the data base compiled in the LEARN mode. Signature and circuit connection information comprise the basic lists for backtrace and signature matching modes of troubleshooting. These lists are automatically generated by the 55005S software.

Documentation

Troubleshooting a digitally based product requires sound documentation. The 55005S system generates a complete set of documentation for effective Signature Analysis troubleshooting. Three forms of printed documentation, or reports, can be generated by the 55005S system. Two of these reports, report-by-part and report-by-node, list the correct signatures for each respective circuit point. These reports comprise the basic documentation found in products designed for Signature Analysis troubleshooting. A third report, the troubleshooting tree, provides an innovative way to perform manual backtracing through a circuit. This troubleshooting tree provides a means, by fol-

lowing through a set of special signature lists, to backtrace systematically through a circuit.

Troubleshooting

Major improvements in troubleshooting productivity translate into recurring manufacturing and service savings. Two troubleshooting modes in the 55005S provide these productivity improvements for both highly skilled technicians and lower skill level personnel.

Higher skill level operators benefit from the 55005S's ability to indicate if a probed signature matches a correct signature existing in the unit under test's data base. This allows the operator to troubleshoot a product efficiently using knowledge of the circuit's operation, technical experience and intuition. Enhanced productivity results from this extension of the technician's efficiency.

A guided backtrace mode in the 55005S aids the lower skill level person in troubleshooting digital products. All probing and measuring is controlled by the software program. The operator repeatedly probes the circuit, as directed by the controller, until the 55005S system locates the faulty node. A full report printout of probing history, location of the faulty node, and circuit points connected to the bad node occurs upon locating the fault. This report can then assist a technician in repairing the circuit assembly.

Configuration

Three system configurations (development, troubleshooting, and basic configuration) cover a variety of troubleshooting applications. Service support engineering, manufacturing, and field service organizations can select a system configuration which meets their exact needs. A full development system, for example, could support the troubleshooting procedure and documentation generation requirements found in a service support group. Manufacturing and field service would benefit from the cost savings and optimized performance available in the troubleshooting system configuration. Each system offers the flexibility to upgrade to higher performance configurations when the need arises.

DIGITAL CIRCUIT TESTERS

Signature Multimeter, Combines Counter and Multimeter Functions with Signature Analysis

Model 5005A/B

- Digital and analog measurement capability optimized for digital troubleshooting
- Easy to use single probe measurement of logic signals, voltage, and frequency
- 25 MHz, multiple logic family signature analysis with qualified clocking mode
- Compact and portable (5005A)

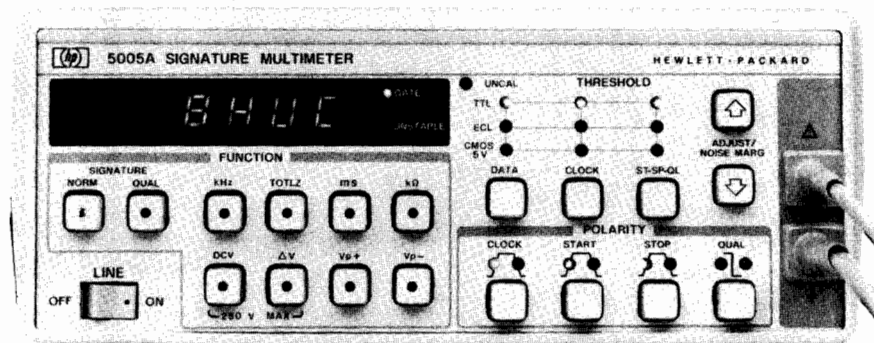

5005A Signature Multimeter

Description

Total checkout of a digital system often requires characterizing both digital data activity and analog signal parameters. A typical troubleshooting procedure may specify a digital multimeter for checking power supplies and circuit board integrity (shorts and opens), a universal counter to measure clock frequencies and time intervals between signals, and a means to verify the analog integrity of active digital signals. The 5005 Signature Multimeter offers, in a single instrument, a measurement set optimized for these types of digital troubleshooting applications.

Two versions, the 5005A for manual applications and the 5005B for automatic test system applications, share common performance capabilities. Their feature set includes:

- Field proven Signature Analysis (for multiple logic families).
- Digital multimeter (DC volts, resistance and differential voltage).
- Frequency counter (frequency, totalize, time interval).
- Voltage threshold (upper voltage peak, lower voltage peak).
- Multifunction probe.

Signature Analysis

HP's patented Signature Analysis technique enables the 5005 to generate a compressed, four digit "fingerprint" or signature of the digital data stream at a logic node. Any fault associated with a device connected through the node will force a change in the data stream and, consequently, produce an erroneous signature. A more in-depth discussion of Signature Analysis can be found in the HP Application Note Series 222.

Specific features of the 5005 Signature Analyzer include:

- Multiple logic family compatibility—preset threshold levels for TTL, CMOS, and ECL or adjustable thresholds (+12.5 V to -12.5 V) assure coverage of a wide variety of logic device types.
- 25 MHz clock frequency—extends Signature Analysis to high speed circuits such as CRT controllers.
- Qualified signature mode—speeds fault isolation in complex products by windowing signature collection to specific modules or devices without requiring major test setup changes. This simplifies the engineering involvement in hardware and software testability and accelerates test procedure preparation.

Digital Multimeter

Certain digital problems result from analog circuit failures: a low power supply voltage, an open shorted circuit path, a faulty A/D or D/A converter. Each may contribute to a system failure. The 5005 contains a 4½ digit dc voltmeter, ohmmeter, and differential voltmeter, each with performance geared toward analog measurements necessary in digital troubleshooting.

The implementation of each multimeter function emphasizes simplicity and convenience. Automatic internal self calibration and auto-ranging maximize troubleshooting efficiency by eliminating unnecessary interaction with the instrument. Improvements in display interpretation also aid troubleshooting. The ohmmeter, for example, when measuring an open circuit, produces an "OPEN" indication on the display rather than the typical overload display.

Frequency Counter

The counter within the 5005 provides totalize and frequency measurements to 50 MHz, and time interval measurements to 100 nanosecond resolution. Intended to extend the digital troubleshooting capabilities of the Signature Analysis (synchronous measurements), the counter functions provide the ability to characterize one-shots and timers through time interval measurement; test interrupt lines, reset lines, and asynchronous communication interfaces (RS-232) through totalize, and verify clock and clock driver circuitry through frequency measurement.

Voltage Threshold

Logic level degradation is a common and troublesome malfunction in digital products. Isolating this failure typically requires displaying and interpreting the waveform. The 5005's peak voltage measurement mode provides a simple, direct method of measuring logic high and logic low voltage of active digital signals.

The peak voltage measurement mode allows the 5005 to characterize and display either the greatest (positive peak) or lowest (negative peak) voltage measured at the probe. Selection of either positive peak or negative peak mode displays the appropriate measured threshold for comparison against the specifications of the logic family.

- Complete HP-IB programmability of every function
- Measurement trigger switch in probe
- Rack and stack enclosure (5005B)
- Programmable audible beeper

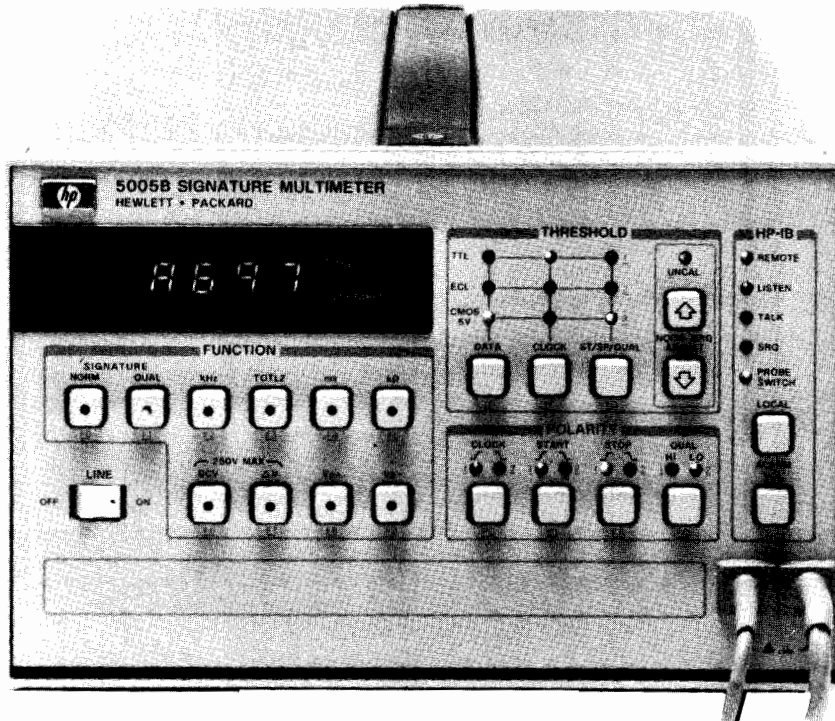

5005B Programmable Signature Multimeter



Multifunction Probe

Several measurement functions incorporated into a single instrument can provide optimal troubleshooting efficiency only when each function is easy to use. The operator, when troubleshooting, must be able to measure the analog signal parameters and digital functional characteristics of a node without requiring time consuming and error-prone probe or instrument setup changes. The 5005 multifunction probe solves this problem by providing automatic access to the Signature Analyzer, multimeter, and counter functions through a single probe. All signal multiplexing to the appropriate measurement function is accomplished inside the 5005.

This efficient probing scheme becomes particularly important in automatic applications. The 5005B takes advantage of the several functions available in the multifunction probe. A switch, located on the side of the probe, allows the operator to trigger automatic measurement. The instrument controller can then characterize both the analog parameters and functional digital operation of a circuit node while the operator probes the same point. This greater automatic measurement efficiency translates into increased troubleshooting productivity.

HP-IB Programmability

Complete programmability makes the 5005B an ideal choice for automatic digital testing and troubleshooting. Every 5005B measurement and control function can be programmed through the HP-IB interface. This flexibility allows the automatic test system designer full access to the many measurement functions in the instrument.

Simplified programming enhances the automatic testing and troubleshooting productivity improvements inherent in the 5005B. Straightforward commands and data output formats aid in accelerating test program development. A measurement trigger switch located in the probe allows direct operator communication to the controller. Audible feedback, supplied by the beeper in the 5005B, can then indicate the completion of the measurement cycle. This closed-loop communication (controller-to-operator) aides in improving troubleshooting efficiency.

Portability

The 5005A offers a compact portable solution for manual troubleshooting of digitally based products. Its compact package, complete measurement capabilities and multifunction probe, make it invaluable as a bench or field service tool. This complete measurement set, combined into a single instrument, insures you always having the necessary troubleshooting capabilities in hand.

The identical feature set between the 5005A and 5005B also simplifies going from automatic to manual troubleshooting procedures. Consistent front panel function key arrangements and performance specifications allow direct translation of test or troubleshooting procedures. Your investment in an automatic procedure provides an additional return when expanding into a manual troubleshooting environment.

DIGITAL CIRCUIT TESTERS

Signature Multimeter, Combines Counter and Multimeter Function with Signature Analysis
Model 5005A/B (cont.)

5005A/B Specifications

Signature

Display: 4 digits. Characters 0-9, ACFHPU.

Fault detection accuracy: 100% probability of detecting single-bit errors; 99.998% probability of detecting multiple-bit errors.

Minimum gate length: 1 clock cycle (1 data bit) between START and STOP.

Maximum gate length: no limit.

Minimum timing between gates: 1 clock cycle between STOP and START.

Data Probe Timing

Setup time: 10 ns (data to be valid at least 10 ns before selected clock edge.)

Hold time: 0 ns (data to be held until occurrence of selected clock edge.)

START, STOP, QUAL Timing

Setup time: 20 ns (signals to be valid at least 20 ns before selected clock edge.)

Hold time: 0 ns (signals to be held until occurrence of selected clock edge.)

CLOCK Timing

Maximum clock frequency: 25 MHz.

Minimum pulse width: 15 ns in high or low state.

Qualify mode: allows data clock qualification by an external signal. DATA probe input impedance ≈ 50 k Ω to the average value of "0" and "1" threshold settings (± 6 V max); 15 pF.

START, STOP, CLOCK, QUAL input impedance ≈ 100 k Ω ; 15 pF.

Front panel indicators: flashing GATE light indicates detection of valid START, STOP, CLOCK conditions. Flashing UNSTABLE light indicates a difference between 2 successive signatures, and possible intermittent faults.

Frequency

Display: 5 digits.

Ranges: 100 kHz, 1 MHz, 10 MHz, 50 MHz, autoranged.

Resolution: 1 LSD (1 Hz on 100 kHz range).

Accuracy: $\pm 0.01\%$ of reading ± 1 count.

Minimum pulse width ≈ 10 ns in high or low state.

Gate time ≈ 1 s, fixed.

Input impedance ≈ 50 k Ω to the average value of "0" and "1" threshold settings (± 6 V max); 15 pF.

Totalizing

Display: 5 digits.

Range: 0-99,999 counts.

Resolution: 1 count.

Maximum input frequency ≈ 50 MHz, with a minimum pulse width of 10 ns, and minimum pulse separation of 10 ns.

Minimum START/STOP pulse width ≈ 20 ns.

DATA input impedance ≈ 50 k Ω to the average value of "0" and "1" threshold settings (± 6 V max); 15 pF.

START, STOP input impedance ≈ 100 k Ω ; 15 pF.

Time Interval

Display: 5 digits.

Ranges: 10 ms, 100 ms, 1 s, 10 s, 100 s, autoranged.

Resolution: 1 count (100 ns on 10 ms range).

Accuracy $\pm 0.01\%$ of reading ± 2 counts.

Minimum START/STOP pulse width ≈ 20 ns.

START, STOP input impedance ≈ 100 k Ω ; 15 pF.

Resistance

Display: 4 or 5 digits, depending on range.

Ranges: 30 k Ω , 300 k Ω , 1 M Ω , 3 M Ω , 10 M Ω , autoranged.

Accuracy: (at 15°C–30°C).

RANGE	FULL SCALE	ACCURACY	DISPLAY RESOLUTION
30 k Ω	29.999 k Ω	$\pm 1\%$ of reading $\pm 2 \Omega$	1 Ω
300 k Ω	299.99 k Ω	$\pm 1\%$ of reading	10 Ω
1 M Ω	999.9 k Ω	$\pm 1\%$ of reading	100 Ω
3 M Ω	2999. k Ω	$\pm 10\%$ or reading	1 k Ω
10 M Ω	10000. k Ω	$\pm 10\%$ of reading	10 k Ω

Input impedance ≈ 20 k Ω to ± 2 V

DC Voltage

Display: 4½ digits.

Ranges: ± 25 V, ± 250 V, autoranged; referenced to earth ground.

Accuracy: (at 15°C–30°C).

RANGE	ACCURACY	RESOLUTION
25 V	$\pm 0.1\%$ of reading ± 2 mV	1 mV
250 V (<100 V)	$\pm 0.25\%$ of reading ± 20 mV	10 mV
250 V (≥ 100 V)	$\pm 0.25\%$ of reading ± 20 mV	100 mV

Input impedance ≈ 10 M Ω .

Differential Voltage

Reading: reads input voltage present at the probe and displays difference between it and voltage at the time ΔV key was depressed.

Specifications: same as for DCV, above. Voltage range is determined by larger of 2 compared voltages.

Peak Voltage

Display: 3½ digits.

Range: 0– ± 12 Vp.

Resolution: 50 mV.

Accuracy: $\pm 2\%$ of reading $\pm 5\%$ of p-p signal ± 100 mV.

Minimum peak duration ≈ 10 ns.

Maximum time between peaks ≈ 50 ms.

Input impedance ≈ 100 k Ω ; 15 pF.

Signature Analyzer Logic Thresholds

Preset thresholds: TTL, ECL, CMOS.

Adjustable thresholds: each preset threshold can be adjusted.

Range: ± 12.5 V, in 50 mV steps.

Accuracy: $\pm 2\%$ of setting, ± 2 V

Logic threshold circuitry is operative during NORM, QUAL, kHz, TOTLZ and ms measurements.

General

Data probe tip: acts as high-speed logic probe in the NORM, QUAL, kHz and TOTLZ modes. Lamp indicates high, low, bad-level and pulsing states.

Minimum detected pulse width is 10 ns.

Data Probe Protection

Continuous Overload

DCV, ΔV , k Ω modes only: ± 250 V ac/dc.

All other modes: ± 150 V ac/dc, 20 V rms at input frequencies > 2 MHz.

Intermittent overload: ± 250 V ac/dc, up to 1 min, for all modes.

Timing Pod Protection

Continuous overload: ± 100 V ac/dc, 20 V rms at input frequencies > 2 MHz.

Intermittent overload: ± 140 V ac/dc, up to 1 min.

Auxiliary power supply: three rear-panel connectors supply 5 V at 0.7A total for accessories (5005A only)

Operating temperature: 0°C to +55°C.

Power: selectable 100 V, 120 V, 220 V or 240 V ac line (+5%–10%), 5005A–48–440 Hz, 35 VA maximum.

5005B–48–66 Hz, 35 VA maximum.

Weight: 5005A–Net: 3.5 kg, (8.0 lb.) Shipping: 10 kg, (22.5 lb.).

5005B–New: 5.5 kg, (12.0 lb.) Shipping: 8.7 kg, (19 lb.).

Size: 5005A–90 mm H x 215 mm W x 410 mm D (3½" x 8½" x 16"), excluding handle.

5005B–133 mm H x 212 mm W x 432 mm D (5¼" x 8¾" x 17"), excluding handle.

5005A Signature Multimeter

5005B Signature Multimeter

Option 910 Additional Manual:



DIGITAL CIRCUIT TESTERS

Signature Analyzer, A Digital Troubleshooting Tool

Model 5006A



- Reduce warranty and service support costs
- Full at-speed testing of digital products

- Reduce comparisons to documentation with composite signature
- Compare signatures in groups with signature memory

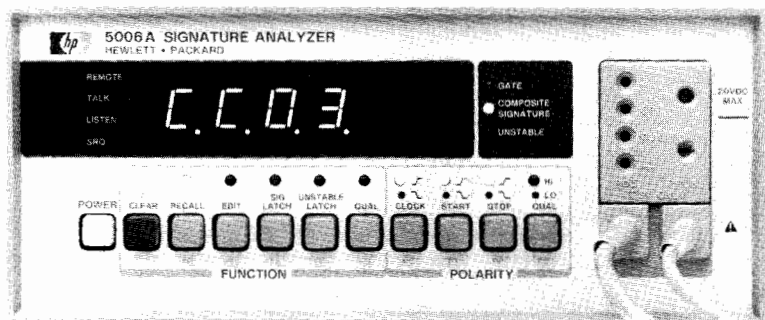

The Technique

Signature Analysis is a fast and accurate troubleshooting method for digital circuits. Fault finding is reduced to tracing signal flow and comparing measured signatures to those recorded on paper or in a computer. Troubleshoot with Signature Analysis by probing the circuit, reading the display and comparing to the known good signature. A signature is a cyclic redundancy code (CRC) used as an error detection check on blocks of data. Test patterns may be generated with in a circuit or stimulated externally.

Programmability Means Efficiency

The HP 5006A is completely programmable using the optional HP-IL or HP-IB interfaces. Build a personal digital troubleshooting station to save time, improve productivity and reduce capital expenditures with HP-IL. Upgrade production test and troubleshooting systems to include digital troubleshooting by adding the HP-IB option.

Signatures compress the necessary troubleshooting information of a bit stream into 16 bits. Instead of entire bit streams, only signatures need be compared to detect bit errors in the unit under test.

Time Savers

Composite signature and signature memory save time for the troubleshooter who does not have a computer-aided system. Composite signature is the binary sum of individual signatures. The 5006A computes it for any grouping of digital signals (i.e., bus or IC). Only one "composite" signature need be compared to documentation if all signals for that group are good.

Signatures are stored in the 5006A memory after the probe switch is pushed. The memory stores the last 32 signatures probed. Individual signatures can now be compared in groups instead of after each probe by reviewing the memory in the RECALL mode.

5006A Specifications

General

Display: 4 digits. Characters 0-9, ACFHPU.

Fault detection accuracy: 100% probability of detecting single-bit errors; 99.998% probability of detecting multiple-bit errors.

Composite signature: maximum number of signatures: No limit.

Sums all signatures, triggered by probe switch, following depression of CLEAR key, or power-up.

Signature memory: signatures recallable by probe switch: The last 32 signatures triggered by probe switch.

Timing

Clock: maximum frequency: 25 MHz. Minimum clock time: 15 ns in high or low state.

Probe: setup time: 10 ns with 0.2V overdrive. (Data to be valid at least 10 ns before selected clock edge.) Hold time: 0 ns. (Data to be held after occurrence of selected clock edge.)

Start, stop, qualifier: setup time: 20 ns with 0.2V overdrive. (Data to be valid at least 20 ns before selected clock edge.) Hold time: 0 ns. (Data to be held until occurrence of selected clock edge.) Minimum gate length: 1 clock cycle (1 data bit) between START and STOP.

Maximum gate length: no limit.

Minimum timing between gates: 1 clock cycle between STOP and START.

Input Impedance

Probe: 50k Ω to ground nominal.

Pod: 100k Ω to ground nominal.

Overload Protection

Probe: $\pm 150V$ continuous.

$\pm 250V$ intermittent.

250V ac for 1 minute.

Pod: $\pm 20V$ continuous.

$\pm 140V$ intermittent.

$\pm 140V$ ac for 1 minute.

CMOS sense: 20V dc maximum.

TTL Thresholds

Probe: Logic one: $2V + .2-.3$. Logic zero: $0.8V + .3-.2$

Pod: 1.4 Volt $\pm .6$

CMOS Thresholds

Logic one: 70% of sensed voltage.

Logic zero: 30% of sensed voltage.

Display and Indicators

Signature: four seven-segment digits with decimal point.

Lamps: Key Status: Recall, edit, signature latch, unstable latch, qualify mode, timing polarities. Programmable: Remote, talk, listen, SRQ. (Option 030 or 040). Status: Composite signature, gate, unstable.

Probe: logic levels indicated: High, low, open and pulsing. Minimum pulse width: 10 nsec.

Other

Selectable power: 115V $+10\%-25\%$ AC line, 48-440 Hz.

230 V $+10\%-15\%$ AC line, 48-66 Hz. 25VA maximum.

Operating environment: temperature: 0-55°C. Humidity: 95% RH at +40°C. Altitude: 4600M. (15,000 ft).

Size: 89 mm high x 216 wide 279 mm deep. (3-1/2 in. x 8-1/2 in. x 11 in.)

Net weight: 2.4 kg (5.3 lbs). Shipping weight: 4.1 kg (9 lbs)

Options and Accessories

Option 30: HP-IL Interface

Option 40: HP-IB Interface

Option 910: Additional Manual

5060-0173 Half Rack Mount Kit

82167A 1/2 M HP-IL Cable

5006A Signature Analyzer



DIGITAL CIRCUIT TESTERS

Microprocessor Exerciser, 6800, 6802, 6808, 8085 and Z-80 Support

Model 5001A, B, C, and D

- External stimulus for signature analysis troubleshooting
- Over 50 preprogrammed tests
- Full I/O wraparound testing
- Unique memory overlay for preprogrammed tests

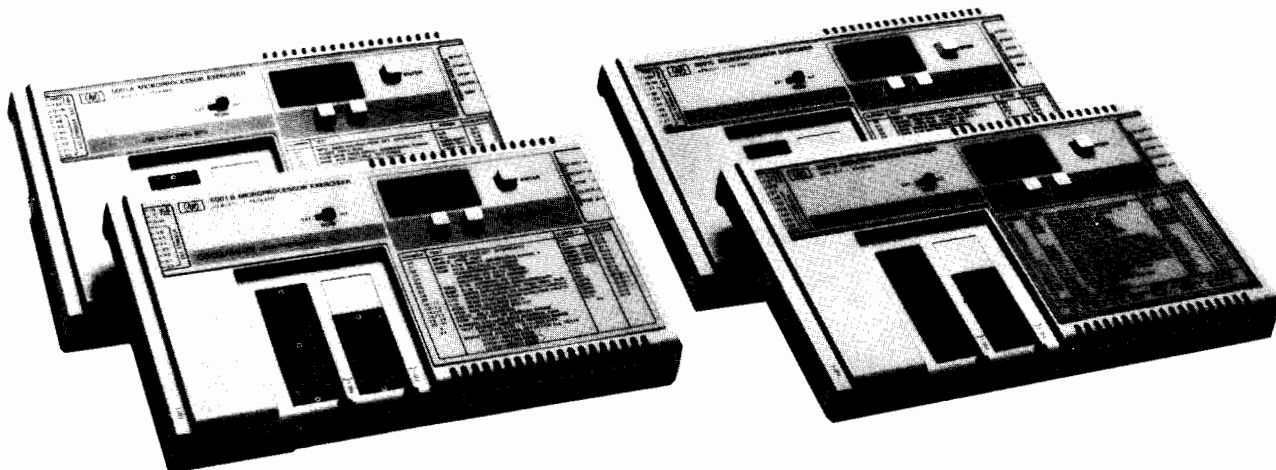

5001 Microprocessor Family

Description

The HP 5001 series of Microprocessor Exercisers offers a new alternative to add enhanced testability, in microprocessor-based products. Used in conjunction with a Signature Analyzer, the HP 5001 provides an external source of either preprogrammed or custom test stimulus to the microprocessor or input ports of a system. The operator simply removes the microprocessor from the system under test, connects the HP 5001 Microprocessor Exerciser, and utilizing the three button front panel, selects the test program to execute.

Preprogrammed Test Stimuli

Front panel switches on the 5001 allow selection of over 50 preprogrammed tests which are stored in its ROM. These test stimuli include:

- A test of the microprocessor instruction set and interrupts.
- A free-run test for address and data bus integrity.
- ROM read tests.
- RAM read-write tests.
- Output port pattern tests.
- Input port pattern tests.

The 5001 utilizes the microprocessor of the product under test to repetitively execute preprogrammed stimuli.

Custom Test Stimuli

The 5001 can be utilized to run custom programs for those portions of the product under test which require stimulus beyond that provided by the preprogrammed routines. It has a socket which allows instructions to be executed from a custom programmed ROM. The user writes stimulus programs, generates a PROM containing the appropriate microprocessor code and places it into the 5001 to execute up to 2 Kbytes of external stimulus. Typical custom tests could include:

- Configuration and stimulus for PIA's.
- Pattern stimuli for sequential logic outboard of output ports.
- Go/no go functional tests.

Memory Overlay

A unique memory overlay scheme makes all preprogrammed tests and custom ROM programs independent of the system under test

memory map. A product may use its entire memory space without reserving ROM space for test programs. Additionally, this feature allows all programs to run independently of memory faults in the system under test.

Single Signature Tests

Certain preprogrammed stimuli are designed to provide pass/fail information on the microprocessor, RAM and ROM through a single signature. For example, to save troubleshooting time a particular RAM test requires collecting only a single signature to verify a RAM rather than collecting signatures of all RAM pins.

Qualified Stimuli

Some stimuli utilize a "qualify" line to optimize testing by dynamically modifying the effective address range of the preprogrammed test. For example, the output port tests call for the qualify line to be connected to the chip-enable pin of the port to be tested. The microprocessor searches its address field until that chip is enabled (and the qualify line asserted) then writes all possible patterns to that port, repetitively.

Bus Signatures

The 5001 can read data from the product under test, as well as write patterns into it. Certain stimuli utilize this feature to read bus data, serialize it, and output a single bit stream. This "bus signature" saves time and reduces the potential errors in probing several separate points on a bus.

Input Port Stimuli

The 5001 has eight output lines under microprocessor control. These can be used to stimulate input ports or circuitry within the product under test without requiring additional equipment, connectors, or fixtures. Reading the results into the 5001 allows full wrap-around testing of the product under test.

SA Interface

A signature analyzer port on the 5001 allows quick and easy connection of START, STOP, CLOCK, and ground. Full control of these signals through either preprogrammed tests or through the custom test ROM saves time by reducing equipment setup changes.

- Support for the 6800, 6802, 6808, 8085 and Z-80 micro-processors
- External ROM socket for customer stimulus

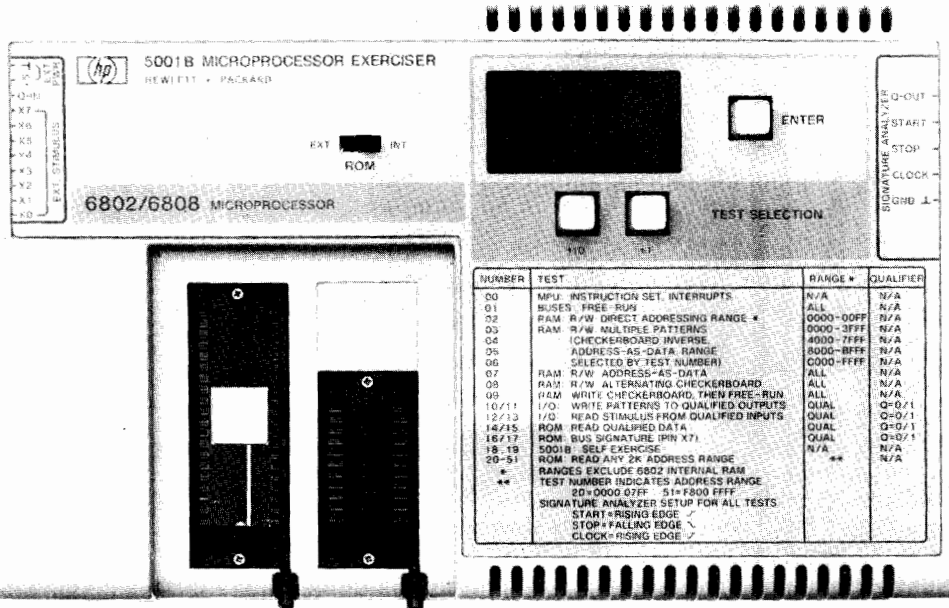

5001B Microprocessor Exerciser (6802 and 6808)

Specifications

Model Number	Micro-processor	Max Clock Frequency (f _{max})		ROM Spec for f _{max}	
		External ROM	Internal ROM	t _{acc}	t _{co}
5001A	6800	2.0 MHz	1.5 MHz	250 ns	190 ns
5001B	6802; 6808	2.0 MHz	1.5 MHz	250 ns	190 ns
5001C	8085A	6.25 MHz	6.25 MHz	557 ns	256 ns
5001D	Z-80A	4.0	4.0 MHz	335 ns	245 ns

t_{acc}-maximum address-to-output delay.
t_{co}-maximum chip select-to-output delay.
External ROM type-Intel 2716 EPROM or equivalent.
Minimum clock rate-as specified by manufacturer.
5001C Internal Crystal (awitch selectable)-4 MHz.

General Specifications

Operating temperature: 0-55°C.
Power requirements: +5 V DC ± 5%
5001A: 550 mA Nominal.
5001B: 550 mA Nominal.
5001C: 500 mA Nominal.
5001D: 550 mA Nominal.
Excluding the microprocessor and external custom ROM.
Shipping weight: 1.36 kg (3 lbs).
Dimensions: 235 mm L x 140 mm W x 26 mm H (9¼" x 5½" x 1").

Accessories and Options

Accessories include: microprocessor interface ribbon cable, external stimulus port cable, external power cable, 11 test point grabbers, protective carrying case, and operating and programming manual.

- Option 910:** Extra Manual
- 5001A** Microprocessor Exerciser for 6800 Systems
- 5001B** Microprocessor Exerciser for 6802/6808 Systems
- 5001C** Microprocessor Exerciser for 8085 Systems
- 5001D** Microprocessor Exerciser for Z-80 Systems

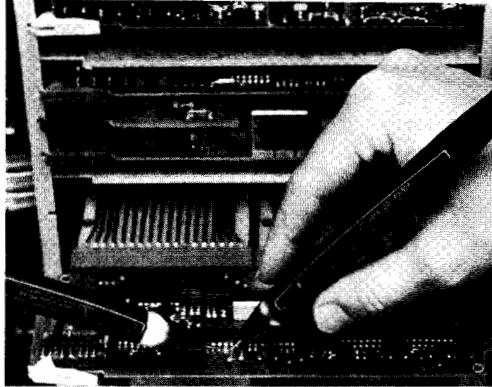

545A/546A

Logic Probes

Logic Probes greatly simplify tracing logic levels and pulses in IC circuits to find nodes stuck HIGH or LOW, intermittent pulse activity, and normal pulse activity. That's because they instantly show whether the node probed is high, low, bad level, open circuited, or pulsing.

Logic Probes require a simple connection to the circuit under test's power supply, and they're ready to use. The strain-relieved power cord, and line-voltage protected tip insure long life and durability. High input impedance protects against circuit loading, not just in the HIGH state, but for logic LOWs as well.

545A TTL/CMOS Logic Probe

The HP Model 545A Logic Probe contains all the features built into other HP probes, plus switch-selectable, multi-family operation and built-in pulse memory. Employing the same straightforward one-lamp display as our other probes, the 545A operates from 3 to 18 volts in CMOS applications or from 4.5 to 15 V dc supplies in the TTL mode while maintaining standard TTL thresholds.

The probe's independent, built-in pulse memory and LED display help you capture hard to see, intermittent pulses. Just connect the probe tip to a circuit point, reset the memory, and wait for the probe to catch those hard to find glitches. The memory captures and retains a pulse until reset.

The hand-held 545A is light, rugged, overload protected, and very fast: 80 MHz in TTL, 40 MHz in CMOS. It also employs handy power supply connectors that enable you to easily hook up to supply voltage almost anywhere in the unit under test.

10525T Logic Probe

The Model 10525T Logic Probe provides TTL/DTL troubleshooting at low cost. Ideally suited to 5 volt logic applications, the 10525T has high input impedance, overload protection, and 50 MHz data rate capability.

ECL Logic Probe

The HP Model 10525E Logic Probe extends time-proven, cost-saving logic probe troubleshooting techniques to high-speed ECL logic.

Operation of the ECL probe is analogous to that of the 10525T except the 10525E's high speed circuitry stretches single shot phenomena so that single pulses as narrow as 5 nanoseconds may be observed.

The 10525E may be powered directly from any -5.2 volt source and its high input impedance minimizes circuit loading.

Accessories included: BNC to alligator clips, ground clip.

Accessories Available

00545-60104 Tip Kit for 545A Probe, 546A Pulser
10525-60012 Tip Kit for 10525T Probe, 10526T Pulser
10525-60015 Pulse Memory for 10525T Probe

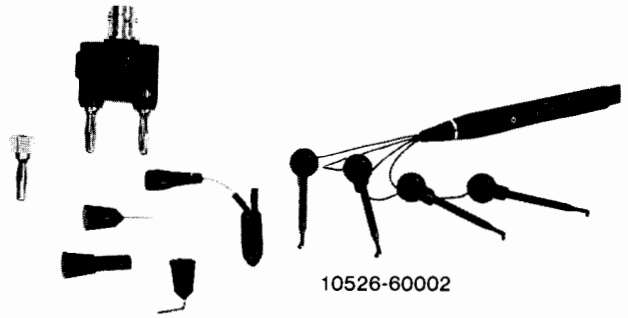

10526-60002

545A Probe Specifications

Input current: $\leq 15 \mu\text{A}$ (source or sink).

Input capacitance: $\leq 15 \text{ pF}$.

Logic thresholds

*TTL: Logic one $2.0 + 0.4$, -0.2 V . Logic zero $0.8 + 0.2$, -0.4 V .

CMOS: $3-10 \text{ V dc supply}$

Logic one: $0.7 \times V_{\text{supply}} \pm 0.5 \text{ V dc}$.

Logic zero: $0.3 \times V_{\text{supply}} \pm 0.5 \text{ V dc}$.

CMOS: $\geq 10-18 \text{ V dc supply}$.

Logic one: $0.7 \times V_{\text{supply}} \pm 1.0 \text{ V dc}$.

Logic zero: $0.3 \times V_{\text{supply}} \pm 1.0 \text{ V dc}$.

Input minimum pulse width: 10 ns using ground lead (typically 20 ns without ground lead).

Input maximum pulse repetition frequency:

TTL, 80 MHz. CMOS, 40 MHz.

Input overload protection: $\pm 120 \text{ V}$ continuous (dc to 1 KHz); ± 250 for 15 seconds (dc to 1 kHz).

Pulse memory: indicates first entry into valid logic level; also indicates return to initial valid level from bad level for pulse $\geq 1 \mu\text{s}$ wide.

Power Requirements

TTL: 4.5 to 15 V dc*.

CMOS: 3 to 18 V dc.

Maximum current: 70 mA.

Overload protection: $\pm 25 \text{ V dc}$ for one minute.

Accessory included: ground Clip (HP Part No. 00545-60105).

* $\pm 5 \pm 10\%$ V dc power supply; usable to $+15 \text{ V dc}$ with slightly increased logic low threshold.

10525T Probe Specifications

Input impedance: $> 25 \text{ k}\Omega$ in both the high and low state (< 1 low power TTL load).

Logic one threshold: $2.0 \text{ V} + 0.4 \text{ V}$, -0.2 V .

Logic zero threshold: $0.8 \text{ V} + 0.2 \text{ V}$, -0.4 V

Input minimum pulse width: 10 ns.

Input maximum pulse repetition frequency: 50 MHz.

Input overload protection: ± 70 volts continuous, ± 200 volts intermittent, 120 V ac for 30 seconds, 240 V ac for 10 seconds.

Power requirements: 5 V $\pm 10\%$, -5% at 60 mA, internal overload protection for voltages from $+7$ to -15 volts. Includes power lead reversal protection.

Accessories included: BNC to alligator clips; ground clip.

10525E ECL Probe Specifications

Input impedance: 12 k Ω in both the high and low state.

Logic one threshold: $-1.1 \text{ V} \pm 0.1 \text{ V}$.

Logic zero threshold: $-1.5 \text{ V} \pm 0.1 \text{ V}$.

Input minimum pulse width: 5 ns.

Input maximum pulse repetition frequency: 50 MHz (typically 100 MHz at 50% duty cycle).

Input overload protection: ± 70 volts continuous, 200 volts intermittent, 120 V ac for 30 seconds.

Power requirements: $-5.2 \text{ V} \pm 10\%$ at 80 mA; supply overload protection for voltages from -7 to $+400$ volts.

Ordering Information

545A Logic Probe
10525T Logic Probe
10525E Logic Probe

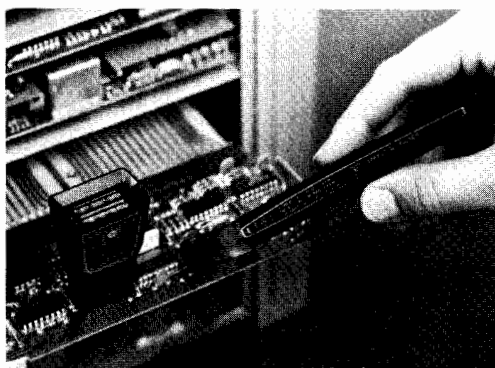

548A/546A

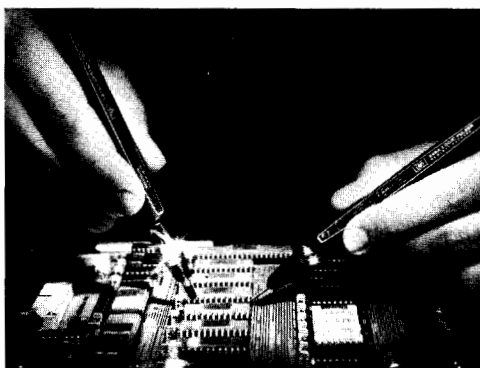

547A/546A



Logic Pulser

The Logic Pulser solves the problem of how to pulse IC's in digital circuits. Merely touch the Pulser to the circuit under test, press the pulse button and all circuits connected to the node (outputs as well as inputs) are briefly driven to their opposite state. No unsoldering of IC outputs is required. Pulse injection is automatic, high nodes are pulsed low and low nodes, high, each time the button is pressed.

Ability to source or sink up to 0.65 Amperes insures sufficient current to override IC outputs in either the high or low state. Output pulse width is limited so the amount of energy delivered to the device under test is never excessive. Additionally, the Pulser output is three-state so that the circuit under test is unaffected until the Pulser is activated.

546A Logic Pulser

Automatic polarity pulse output, pulse width, and amplitude make for easy multi-family operation when you use the 546A Logic Pulser. But, the real surprise comes when you code in one of its six ROM-programmable output patterns (single pulses; pulse streams of either 1, 10, or 100 Hz; or bursts of 10 or 100 Hz; or bursts of 10 or 100 pulses). This feature allows you to continually pulse a circuit when necessary, or it also provides an easy means to put an exact number of pulses into counters and shift registers. Used with our multi-family IC Troubleshooters, the 546A acts as both a voltage and current source in digital troubleshooting applications.

10526T Logic Pulser

The economical 10526T provides dependable single-shot operation in TTL/DTL applications. Just press the pulse button, and the pulser delivers a single powerful pulse of the correct pulse width, polarity and amplitude.

Digital Current Tracer

The 547A Current Tracer precisely locates low-impedance faults in digital circuits by locating current sources or sinks. For example, on a bad node the Tracer can verify that the driver is functioning and also show where the problem is by tracing current flow to the source or sink causing the node to be stuck. The Tracer is designed to troubleshoot circuits carrying fast rise-time current pulses. The Tracer senses the magnetic field generated by these signals in the circuit and displays transitions, single pulses, and pulse trains using a simple one-light indicator. Because it is not voltage sensitive, the Tracer operates on all logic families having current pulses exceeding 1 mA, including CMOS, where even lightly loaded outputs can have up to 2 to 3 mA of instantaneous charging current.

To use the Tracer, align the dot on its tip at a reference point, usually the output of a node driver. Set the sensitivity control to indicate the presence of ac current activity. As you probe from point to point or follow traces, the lamp will change intensity; when you find the fault the Tracer will indicate the same brightness found at the reference point.

546A Pulser Specifications

Output

Family	Output Current	Pulse Width	Typical Output Voltage	
			HIGH	LOW
TTL/DTL	≤650 mA	≥0.5 μs	≥3 V dc	≤0.8 V dc
CMOS	≤100 mA	≥5.0 μs	≥(V _{supply} - 1 V dc)	≤0.5 V dc

Power supply requirements: TTL; 4.5 to 5.5 V dc at 35 mA, CMOS; 3 to 18 V dc at 35 mA, protected to ±25 V dc for 1 min.

10526T Pulser Specifications

Output high pulse voltage: >2 V at 0.65 A (1 A typical at V_{ps} = 5 V, 25°C).

Output low pulse voltage: <0.8 V at 0.65 A (1 A typical at V_{ps} = 5 V, 25°C).

Output impedance, active state: <2 ohms.

Output impedance, off state: >1 Megohm.

Pulse width: 0.3 μs nominal.

Input overload protection: ±50 volts continuous.

Power supply input protection: ±7 volts (includes power lead reversal protection).

Power requirements: 5 V ±10% at 25 mA.

Accessories included: BNC to alligator clips, ground clip.

547A Current Tracer Specifications

Input

Sensitivity: 1 mA to 1 A.

Frequency response: light indicates single-step current transitions; single pulses ≥50 ns in width; pulse trains to 10 MHz (typically 20 MHz for current pulses ≥10 mA).

Risetime: light indicates current transitions with risetime ≤200 ns at 1 mA.

Power Supply Requirements

Voltage: 4.5 to 18 V dc.

Input current: ≤75 mA.

Maximum ripple: ±500 mV above 5 V dc.

Overvoltage protection: ±25 V dc for one minute.

Accessories Available

00545-60104: Tip Kit for 546A Pulser, 545A Probe

10525-60012: Tip Kit for 10526T Pulser, 10525T Probe

10526-60002: Multi-Pin Stimulus Kit

Ordering Information

546A Logic Pulser

10526T Logic Pulser

547A Digital Current Tracer

DIGITAL CIRCUIT TESTERS

Logic Clip, Logic Comparator

Models 548A & 10529A



Logic Clip

The Logic Clip is an extremely handy service and design tool which clips onto dual-in-line package (DIP) ICs, instantly displaying the states of up to 16 pins. Each of the clip's 16 LEDs independently follows level changes at its associated pin. Lit diodes are logic High, extinguished diodes are Low.

The Logic Clips's real value is in its ease of use. It has no controls to set, needs no power connections, and requires practically no explanation as to how it is used. The Clip has its own gating logic for locating ground and V_{CC} pins and its buffered inputs reduce circuit loading.

The Logic Clip is much easier to use than either an oscilloscope or a voltmeter when you are interested in whether a circuit is in the high or low state, rather than its actual voltage. The Clip, in effect, is 16 binary voltmeters, and the user does not have to shift his eyes away from his circuit to make the readings.

The intuitive relationship of the input to the output—lighted diode corresponding a high logic state—greatly simplifies the troubleshooting procedure. The user is free to concentrate his attention on his circuits, rather than on measurement techniques. Also, timing relationships become especially apparent when clock rates can be slowed to about 1 pulse per second.

When used in conjunction with the Logic Pulser, the Logic Clip offers unparalleled analysis capability for troubleshooting sequential used to inject pulses between gates allowing it to supply signals to the IC under test absolutely independent of gates connected to the IC. All outputs may then be observed simultaneously on the Logic Clip. Deviations from expected results are immediately apparent as the Pulser steps the IC through its truth table.

548 Multi-Family Logic Clip

Fully automatic and protected to 30 V dc, and employing bright individual LEDs in its display, the 548A brings multi-family operation to the HP line of IC Troubleshooters. The Clip can be externally powered, if desired, using a simple power connector.

548A Specifications

Input threshold: $(\geq 0.4 \pm 0.06 \times \text{Supply Voltage}) = \text{Logic High}$.

Input impedance: 1 CMOS load per input.

Input protection: 30 V dc for 1 minute.

Supply voltage: 4-18 V dc across any two pins.

Auxiliary supply input: 4.5 to 20 V dc applied via connector. Supply must be ≥ 1.5 V dc more positive than any pin of IC under test.

Supply current: <55 mA.

548A Logic Clip

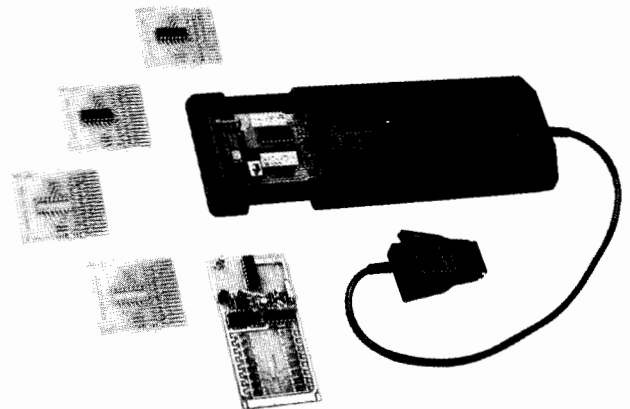

Logic Comparator

The Model 10529A Logic Comparator clips onto powered TTL or DTL ICs and detects functional failures by comparing the in-circuit test IC with a known good reference IC inserted in the Comparator. Outputs of the particular IC to be tested are selected via 16 miniature switches which tell the Comparator which pins of the reference IC are inputs and which are outputs. Any logic state difference between the test IC and reference IC is identified to the specific pin(s) on 14- or 16-pin dual in-line packages on the Comparator's display. A lighted LED corresponds to a logic difference. Intermittent errors as short as 300 nanoseconds (using the socket board) are detected, and the error indication on the Comparator's display is stretched for a visual indication. A failure on an input pin, such as an internal short, will appear as a failure on the IC driving the failed IC; thus a failure indication actually pinpoints a malfunctioning node. A test board is supplied to exercise all of the circuitry, test leads, and display elements to verify proper operation.

10541A: twenty additional blank reference boards; identical to the 10 boards provided with the Logic Comparator.

10541B: twenty preprogrammed reference boards. The 10541B includes the following ICs; 7400, 7402, 7404, 7408, 7410, 7420, 7430, 7440, 7451, 7454, 7473, 7474, 7475, 7476, 7483, 7486, 7490, 7493, 74121, 9601.

10529A Comparator Specifications

Input threshold: 1.4 V nominal (1.8 V nominal with socket board), TTL or DTL compatible.

Test IC loading: outputs driving Test IC inputs are loaded by 5 low-power TTL loads plus input of Reference IC. Test IC outputs are loaded by 2 low-power TTL loads.

Input protection: voltages < -1 V or > 7 V must be current limited to 10 mA.

Supply voltage: 5 V $\pm 5\%$, at 300 mA.

Supply protection: supply voltage must be limited to 7 V.

Maximum current consumption: 300 mA.

Sensitivity

Error sensitivity: 200 ns with reference board or 300 ns with socket board. Errors greater than this are detected and stretched to at least 0.1 seconds.

Delayed variation immunity: 50 ns. Errors shorter than this value are considered spurious and ignored.

Frequency range: maximum operational frequency varies with duty cycle. An error existing for a full clock cycle will be detected if the cycle rate is less than 3 MHz.

Accessories included: 1 test board; 10 blank reference boards; 1 programmable socket board; 1 carrying case.

Accessories Available

10541A: Twenty Blank Reference Boards

10541B: Twenty Pre-programmed Boards

10529A Logic Comparator

DIGITAL CIRCUIT TESTERS

Logic Troubleshooting Kits

Models 5011T, 5015T, 5021A, 5022A, 5023A & 5024A

151



- Complete multi-family kits
- Stimulus-response capability
- In-circuit fault finding

- In-circuit analysis
- Dynamic and static testing
- Multi-pin testing

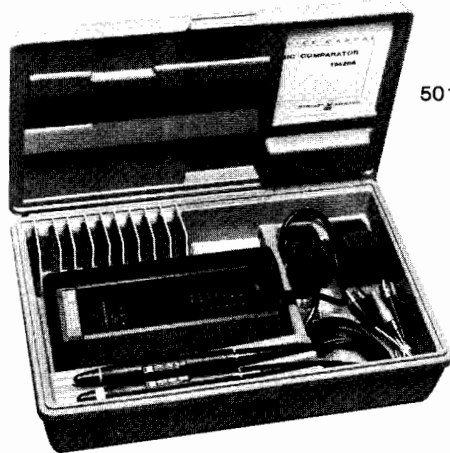

5011T

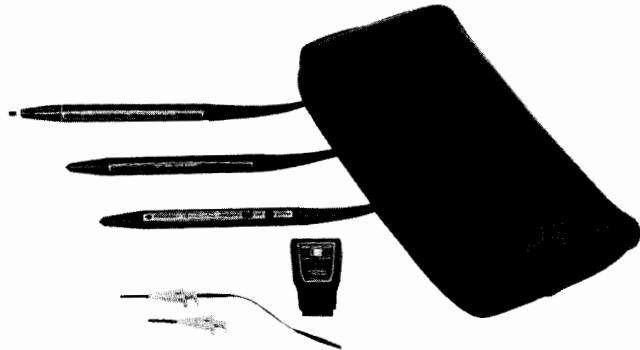

5022A

FAULT	STIMULUS	RESPONSE	TEST METHOD
Shorted Node ¹	Pulser ²	Current Tracer	<ul style="list-style-type: none"> • Pulse shorted node • Follow current pulses to short
Stuck Data Bus	Pulser ²	Current Tracer	<ul style="list-style-type: none"> • Pulse bus line(s) • Trace current to device holding the bus in a stuck condition
Signal Line Short to Vcc or Ground	Pulser	Probe, Current Tracer	<ul style="list-style-type: none"> • Pulse and probe test point simultaneously • Short to Vcc or Ground cannot be overridden by pulsing • Pulse test point, and follow current pulses to the short
Supply to Ground Short	Pulser	Current Tracer	<ul style="list-style-type: none"> • Remove power from circuit under test • Disconnect electrolytic bypass capacitors • Pulse across Vcc and ground using accessory connectors provided • Trace current to fault
Internally Open IC	Pulser ²	Probe	<ul style="list-style-type: none"> • Pulse device input(s) • Probe output for response
Solder Bridge	Pulser ²	Current Tracer	<ul style="list-style-type: none"> • Pulse suspect line(s) • Trace current pulses to the fault • Light goes out when solder bridge passed
Sequential Logic Fault in Counter or Shift Register	Pulser	Clip	<ul style="list-style-type: none"> • Circuit clock de-activated • Use Pulser to enter desired number of pulses • Place Clip on counter or shift register and verify device truth table

Used individually, each of HP's IC Troubleshooters provide their own unique and important troubleshooting function. Together they become invaluable stimulus-response testing partners that help pinpoint faults and ensure fast non-destructive repair of digital circuits.

To help you take advantage of the usefulness of the IC Troubleshooters, HP has packaged them into kits which offer both ordering convenience, and cost savings. Also, applications information is available, such as AN 163-2, "New Techniques of Digital Troubleshooting", to help users derive maximum benefit from these instruments.

The table shows a series of typical node and gate faults and the combination of tools used to troubleshoot the circuit. As with all sophisticated measuring instruments, operator skill and circuit knowledge are key factors once the various clues, or "bits" of information are obtained using the IC Troubleshooters.

To accomplish troubleshooting at the node and gate level, both stimulus (Pulser) and response (Probe, Tracer, Clip and Comparator) instruments are needed. Moreover, instruments with both voltage and current troubleshooting capability help isolate electrical faults where the precise physical location is hard to identify.

The 547A Current Tracer, the latest and most sophisticated of these troubleshooters, lets you "see" current flow on nodes and buses that otherwise appear stuck at one voltage level. Used with the 546A Pulser, stimulus-response testing is now also possible in the current domain.

IC Troubleshooter Kits Ordering Information

Kit	H mm (in)	W mm (in)	D mm (in)	Net Wt kg (lbs, oz)	Ship Wt kg (lbs, oz)
5011T	82.6 (3.25)	203 (8)	311 (12.25)	1.49 (3,5)	2.11 (4,11)
5015T	64 (2.5)	133 (5.25)	286 (11.25)	0.62 (1.6)	0.74 (1,10)
5021A	64 (2.5)	146 (5.75)	298 (11.75)	0.51 (1.2)	0.62 (1,6)
5022A	64 (2.5)	146 (5.75)	298 (11.75)	0.65 (1,7)	0.76 (1,11)
5023A	225 (8.88)	200 (7.88)	337 (13.25)	1.63 (3,10)	2.19 (4,14)
5024A	64 (2.5)	146 (5.75)	298 (11.75)	0.60 (1,5)	0.71 (1,9)

IC Troubleshooter Kits Selection Guide

	545A TTL/CMOS Probe	546A TTL/CMOS Pulser	547A TTL/CMOS Current Tracer	548A TTL/CMOS Clip	10525T TTL Probe	10526T TTL Pulser	10529A TTL Comparator
5011T Kit				X	X	X	X
5015T Kit				X	X	X	
5021A Kit	X	X		X			
5022A Kit	X	X	X	X			
5023A Kit	X	X	X	X			X
5024A Kit	X	X	X				

1. A node is an interconnection between two or more IC's.

2. Use the Pulser to provide stimulus or use normal circuit signals, whichever is most convenient.

Accessories Available

00545-60104: Tip Kit for 545A Probe, and 546A Pulser

10525-60012: Tip Kit for 10525T Probe, 10526T Pulser

10525-60015: Pulse Memory for 10525T Probe

10526-60002: Multi-pin Stimulus Kit for Logic Pulsers

10529-60006: External Reference Kit for 10529A Comparator

10541A: Twenty blank reference boards for 10529A Comparator

10541B: Twenty pre-programmed reference boards for 10529A Comparator

DIGITAL CIRCUIT TESTERS

Digital Education Courses, Microprocessor Lab

Models 5035T, 5036A

- Complete introductory course in practical digital electronics.

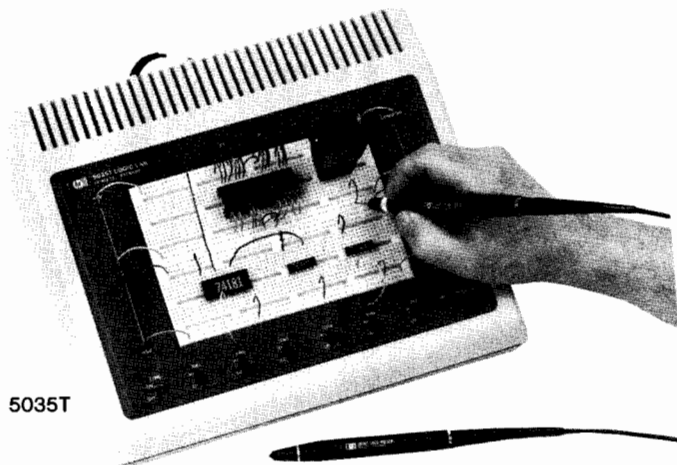

5035T

5035T Complete Logic Lab

Learn logic... the practical way. HP's model 5035T Logic Lab combines theory and lab so you'll learn digital logic quickly, enjoyably, and memorably. Start by building simple circuits and work up to a complete digital clock. Logic labs have been adopted by schools, industrial firms and individuals who want to keep up with the changing world of electronics, and enjoy doing it.

5035T Lab Includes

Mainframe with removable breadboard (see below)

"Practical Digital Electronics"—An Introductory Course

- Complete textbook
- 26 Experiment Workbook

TTL/DTL Test Instruments

- 10525T Logic Probe
- 10526T Logic Pulser
- 548A Logic Clip

Wire and Component Kit

- 32 TTL, MSI, LSI ICs
- 285 Pre-stripped Wires
- 4 Large LED Numerical Displays
- IC Remover

Logic Lab Mainframe

The Logic Lab Mainframe brings convenience and flexibility to breadboarding by allowing solderless connection of new circuit ideas. Fully self-contained, the mainframe has a 5-volt 1-amp power supply, two clocks, four LED indicators, six data switches, two 5-volt BNC connectors, and a handy removable breadboard. To use it, just connect circuits using standard 24-gauge wire, then power up either one or several breadboards to verify new circuit ideas quickly and easily before incurring PC board layout and rework charges.

Accessories Available

- 1258-0121:** Additional breadboard assembly
- 1540-0258:** Heavy duty, padded vinyl carrying case
- 05035-60006:** Wire interconnect kit
- 10656A:** Set of 10 "Practical Digital Electronics", An Introductory Course—Text and Lab Workbook
- 10657A:** Additional component and wire kit

5035T Complete Logic Lab

- Covers hardware, software and troubleshooting in one course.

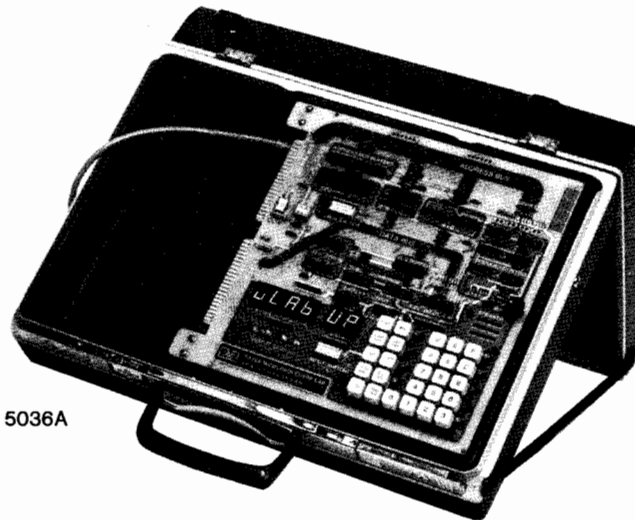

5036A

5036A Microprocessor Lab

Staying Current with Technology

The microprocessor presents a repair problem due to its complexity, and because it is used in so many diverse products. Little imagination is required to anticipate field repair problems with microprocessor-based products like traffic controllers, typesetters, POS terminals, medical instrumentation, etc.

There are scientists and engineers who can contribute to solving this problem by learning about both the hardware and software in microprocessor systems, and there is a virtual army of technicians who need to learn to troubleshoot them. The 5036A Microprocessor Lab provides both the hardware and software basics and vital troubleshooting information needed to solve the microprocessor puzzle.

The 5036A course book, *Practical Microprocessors*, covers both hardware and software in detail in separate chapters containing summaries, hands-on experiments and quizzes. Once these chapters are completed, the course builds up to a series of troubleshooting experiments employing recommended troubleshooting instruments that challenge the user and reinforce microprocessor operating concepts. The book also contains information on the use of oscilloscopes, signature analyzers, logic analyzers, and logic probes for troubleshooting microprocessor-based products.

5036A Major Features

- Color PC board graphics illustrate system block diagrams to enhance learning.
- Multiple-experiment troubleshooting chapter highlights IC Troubleshooters such as 545A Probe, 546A Pulser, 547A Current Tracer and HP Signature Analyzers.
- Plug-in jumpers create real hardware faults that allow realistic troubleshooting practice.
- Complete resident software.
- Dual 5-Volt power supplies, plus edge connectors for expandability.
- LED monitors on all data, address, status and output lines.

Recommended Accessories for Troubleshooting Experiments

- 5024A** Logic Troubleshooting Kit
- 5006A** Signature Analyzer

5036A Microprocessor Lab and Power Supply mounted in briefcase, plus *Practical Microprocessors* text and lab book, in English (German, French and Italian editions are available in those countries).

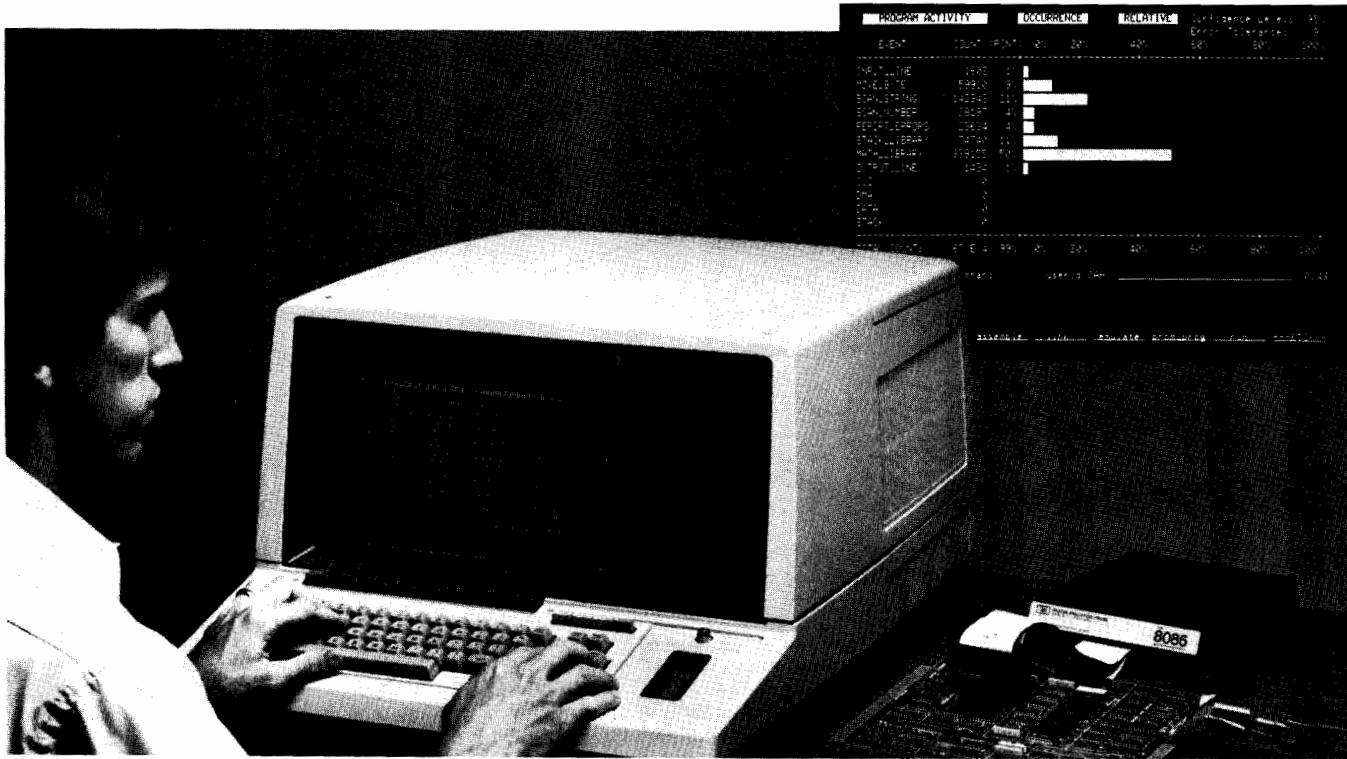

Introduction

Hewlett-Packard logic analyzers and Model 64000 Logic Development System are a family of instruments that support the entire cycle of design, production, testing, and trouble shooting of logic products. Analyzers and the modular development system add to productivity by providing effective tools to accomplish the many tasks in developing digital products. Additional benefits of the logic analyzers and development system are convenience and ease of use; users can focus their attention on design and analysis tasks rather than on the tools.

Logic Design

Model 64000 Logic Development System provides advanced software development, real-time emulation, software analysis, and hardware analysis. These functions may be used separately, combined, or interactively to support all phases of developing microprocessor-based products. A flexible system, Model 64000 can be configured as an integrated cluster of development stations sharing a hard disc memory and printer, a stand-alone unit for emulation and/or analysis using dual flexible disc drives, or as an emulation/analysis terminal to a computer. In any setup, directed syntax softkeys support quicker learning for new users and faster response for experienced users. Software performance analysis with comprehensive, global views of executing programs speed code optimization and program debug. Complete sets of design aid tools are available for many popular microprocessors, including processor specific emulators, assembler/

linkers, preprocessors, inverse assemblers, Pascal compilers, and C compilers.

Logic Analysis

Hewlett-Packard logic analyzers are powerful measurement tools for today's complex digital systems. They are essential during the critical phase of integrating hardware and software. Costly design errors can be avoided by optimizing code and fine-tuning total product performance before production. When the digital products are in production or operation, a logic analyzer is the troubleshooting tool that quickly isolates problems to decrease downtime. Hewlett-Packard logic analysis instruments offer a variety of measurement tools for a wide span of applications. The sophisticated 64000 subsystems may be assembled modularly to provide software performance analysis, state analysis, timing analysis, or emulation bus monitoring. Model 1630A/D Logic Analyzer is suitable for benchtop applications. The analyzer can be used directly with specific microprocessor families, and the 1630A/D Logic Analyzer is also valuable for troubleshooting general digital circuits.

Improved Productivity with Appropriate Tools

Value of design aids and support tools is a function of the degree to which they serve either of two purposes: (1) provide a necessary function not available otherwise, or (2) make it possible to do a task quicker or more effectively. As logic-based products become more complex, the instruments needed to create and test them become correspondingly more complex.

Appropriate development tools can have a direct impact on total development time. A product that goes to market sooner may have a longer life cycle, and, consequently, generate additional revenue. Selecting the right instruments is a very important step, and it becomes much simpler by beginning at the end: first, determine what is to be accomplished with the instruments. Feature sets should be compiled only after analyzing the application environment. By first defining measurement needs, the user assures that there will be adequate measurement power and design aids to support present and future development programs.

Application environments for logic development systems and analyzers can be divided into two major categories: team applications and benchtop applications.

Team Approaches

Marketing pressures together with the complexity of new logic products often dictate a team approach to design and development. The desired result is a compressing of the total development time.

Major milestones in developing a logic product are the same whether the product is created by a team or by an individual. The tasks include setting design criteria, designing and implementing hardware, writing and debugging software, integrating hardware and software, optimizing execution, and documenting all processes for subsequent use by quality control, production, and service. Hewlett-Packard's answer to team development for microprocessor-based and other logic products is the 64000 Logic Development System.

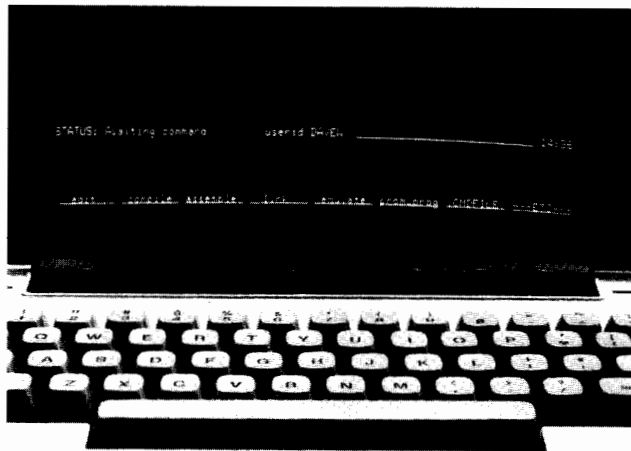

Commands for the 64000 Logic Development System functions are entered using the eight softkeys. Softkey labels are shown above the keys, and new label sets appear automatically.



A user-definable emulator provides emulation support for microprocessors for which there are no processor-specific 64000 System emulators available.

Setting Design Criteria

The initial step is defining what the product is to be. Microprocessor products sufficiently complex to warrant a team effort must be defined in some detail before beginning any programming or circuit design. The convenient 64000 editor function can act as a documentation system from the very first steps in setting criteria. Design criteria are entered in a file available to all members of the design team, and as additions and amendments are made, earlier versions are stored or discarded. The final, agreed-upon paper design remains available throughout the entire project, avoiding duplicated efforts, misunderstandings that can result in incompatible components, and costly oversights. If changes to the guidelines occur during the project, message functions keep all members informed of the latest amendments.

Developing Software and Hardware

Typically, the development task is divided between a hardware team and a software team, and then further divided between the members of each team. In a 64000 System cluster, emulation, development, and analysis functions can be conducted simultaneously at different development stations on the same system.

For the software developer, the 64000 editor is a major advantage. Like all of the 64000 functions, it uses the convenient syntax-driven softkeys. Editing, assembly, compiling, and linking are done from the softkeys and the ASCII keyboard. A program may be written in a high-level language, Pascal or C, and then compiled for the target microprocessor. When a program is linked, modules of high-level language and assembler language can be combined. This gives the programmer the flexibility to program some code in assembly language for tighter, more efficient code in frequently called routines, and still keep the ease and speed gained by programming a high-level language for the greater part of the project.

Emulators serve both hardware and software engineers. A universal development system, the 64000 System offers processor-specific emulators for over 20 popular 8-bit and 16-bit microprocessors. Other processors may be supported by designing and implementing custom-made emulators using the user-definable emulator kit. A ROM emulator adds another form of emulation. When software modules are completed, they can be executed on an emulator even if no target system hardware exists. As hardware units are completed, they can be combined with the emulator performing the functions of the missing hardware. Each emulator has a real-time run mode. Emulators are valuable for exercising software and checking timing relationships, handshake signals, and conformance to electrical specifications as new hardware modules are completed and added to the prototype.

Optimizing System Flow

The Software Performance Analyzer monitors activity on the emulation bus. Model 64310A has six modes for overview measurements of program flow and interactions. Since it operates with the emulator, the Performance Analyzer can be used beginning with the very first steps of product development. Performance analysis is the means for locating bottlenecks and inefficiencies in system execution. Once the problems are identified, performance analysis allows the user to compare the effects of various code modifications and select the optimal revision for the application.

Software performance analysis can be applied throughout the development cycle, and beyond. Overview and module interaction measurements are useful for reworking existing products for more efficient execution.

Integrating Hardware and Software

As modules of the microprocessor-based product are completed, hardware and software are combined and run together. During integration, there is a need to verify that all

modules perform as expected and that the hardware and software execute well together. Rarely is this true. Logic analysis is the major means of detecting problem sources during integration, and evaluating the solutions. The 64000 System offers two highly sophisticated logic analysis subsystems: Model 64600S Logic Timing/Hardware Analyzer and Model 64620S Logic State/Software Analyzer.

Hardware Analysis

Model 64600S Hardware Analyzer offers real-time, transparent timing analysis for 8 or 16 input lines. Four measurement modes (wide sample at 200 MHz, fast sample at 400 MHz, glitch capture, and dual threshold) provide the measurements for checking timing relationships and locating marginal execution. In setting up timing measurements, the inputs may be specified by input bits or with labels. The labels are user defined for specified bit sets for easier interpretation while analyzing the timing displays. Softkeys, labels, a choice of modes, and flexible triggering conditions make it easy to pinpoint precisely the critical program flow to be monitored.

Resource sharing in the 64600S analyzer focuses the full power of the subsystem on each measurement mode. For example, the wide sample mode monitors all input lines, but the fast sample mode swaps off half of the input lines for double the sample rate and twice the memory depth to perform higher resolution measurements. Glitch mode also takes half the input resources to support the separate glitch capture mechanism that captures and displays glitches as narrow as 3 ns. Dual threshold mode trades half the channels to generate three-level timing traces which clearly identify marginal signals and slow signal transitions.

Recent enhancements to the 64600S operating software add extra postprocessing functions to the Hardware Analyzer. The new operating software is included with all new 64600S analyzers, and compatible with

```

Trace:
-----
line# address,opc/data mnemonic opcode or status count:
-----
-007 FFS13 3D CS CMP AX,#0100H 1. uS
-006 FFS14 80 CS instruction fetch 1. uS
-005 FFS15 01 CS instruction fetch 1. uS
-004 FFS16 74 CS JZ FFS25H 1. uS
-003 FFS17 0D CS instruction fetch 1. uS
-002 FFS18 3D CS CMP AX,#no operand, prefetch? 1. uS
-001 FFS25 B1 0 CS MOV CL,#0BH 2. uS
about FFS26 08 CS instruction fetch 1. uS
+001 FFS27 A1 CS MOV AX,B004H 1. uS
+002 FFS28 04 CS instruction fetch 1. uS
+003 FFS29 80 CS instruction fetch 1. uS
+004 FFS2A 25 CS AND AX,#0001H 1. uS
+005 0B04 01 DS read memory lower byte 1. uS
+006 0B05 00 DS read memory upper byte 3. uS
+007 FFS2B 01 CS instruction fetch 1. uS
+008 FFS2C 00 CS instruction fetch 1. uS
-----
STATUS: 1B0B--Running Trace complete 1:19
-----
Trace about address READ_SECTOR+1
-----
CPU trace stop display modify break end ---FPC---

```

Inverse assemblers translate a state analysis measurement into the mnemonics of the target microprocessor. The trace list shown here is a 64620S Software Analyzer trace. Model 1630A/D Logic Analyzer also offers inverse assembly for state listings.

all existing 64600S analyzers. With the new operating system, complete measurements can be stored quickly using the softkeys. The stored measurement is a record of a transparent, real-time timing trace. Once stored, postprocessing functions are available for further analysis and statistical computations. Some of the postprocessing functions are comparing stored and current measurements, marking events of interest, search and find marked states, computing means and standard deviations for a marked time interval, and translating a timing trace into a state listing. Postprocessing adds new capabilities for investigating the collected timing data. Many of the postprocessing functions are automated, saving time and effort for the user.

Software Analysis

Model 64620S Logic State/Software Analyzer subsystem is assembled modularly. With a choice of 20 to 120 channels in 20-channel or 40-channel increments, the software analyzer can be configured to accommodate target systems of varying complexity, including multiprocessor systems. Setting up measurements is simple with softkeys. Parameters for defining measurements may include labels from the symbol table, user-defined labels, and direct or referenced addresses. Resource sharing in the software analyzer is distributed across the trigger, qualify, and store functions. A trigger sequence as deep as 15 terms may be used, or up to three windows can be defined for observing complex state flow. The overview function provides histograms and graphs for basic performance analysis. As many as eight events (addresses, symbols, or ranges) can be compared for relative frequency of occurrence or elapsed time.

Like the hardware analyzer, new operating software for Model 64620S Software Analyzer supports many new software analysis features and capabilities. Most of the added functions are enabling features that provide

the capability to perform analysis and trouble-shooting at the level of the high-level programming languages. Trace lists may be displayed in source language, assembly language, or both. By matching the measurement displays to the written program, another step of translation is omitted, for more efficient analysis. Other added features make the 64620S analyzer easier to use, such as accessing command files from the software analysis mode and an automated store-to-flexible-disc function.

Interactive Subsystems

Any combination of analysis or emulation subsystems in a single development station may be linked for interactive modes using the Intermodule bus (IMB). The IMB supports cross-arming and cross-triggering between analysis subsystems.

For multiprocessor applications, the interactions between processors can be investigated early in hardware development by using emulator analyzers in cross-arming modes. Two timing analyzers can monitor relationships between peripheral control lines and the CPU I/O. Two state analyzers double the combinations of trigger, store, count, sequence, and enable parameters. A powerful combination for the integration stage is a linked Hardware Analyzer and Software Analyzer. With both measurements available simultaneously, it is simple to determine whether some code module fails under unique execution conditions, or that a portion of the circuits are operating marginally and failing intermittently.

The greatest advantage realized with the IMB is the freedom to move smoothly from one function to another. For example, if hardware analysis uncovers a marginal signal, a few keystrokes can activate the emulator analyzer to check the impact of that signal on the code modules related to the signal. When an inefficient subroutine is identified with the Software Performance Analyzer, the Software Analyzer can be

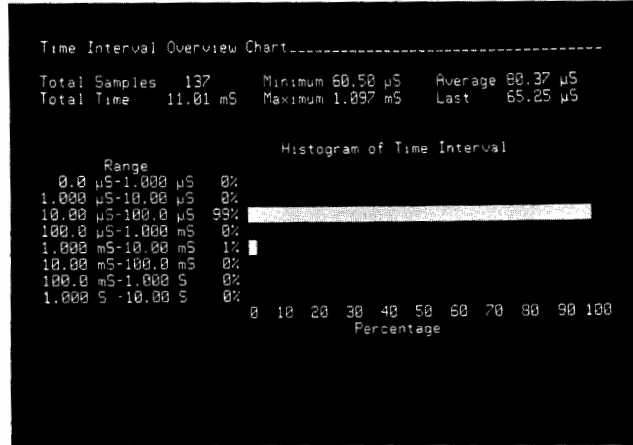

Software performance measurements aid in code optimization and locating bottlenecks in system performance. Performance analysis measurements may be run on the 1630A/D or 64620S state analyzers, or the 64310A Software Performance Analyzer.

armed to trigger on the first address in the subroutine to take a closer look at activity, step by step. The 64000 directed-syntax softkeys make it relatively simple to move between functions in the development station; the IMB makes it possible to change to another subsystem contingent on specified events in the first subsystem.

Documentation Trail

No product is complete without documentation. At the far end of the microprocessor product development, the customer needs some written instructions on the care and use of the product. But long before that, a written history tracking the product from the very first design specifications avoids misunderstandings and misinterpretations during the development phases that follow the first prototype: production, testing, quality control, marketing, manual writing, service. On a hard-disc based 64000 System cluster, a design team can initiate a separate file for documentation while in the process of defining the product criteria. Keeping the file updated is convenient, because text is entered from the same keyboard used for all the other 64000 functions. In this way, documentation required for production will be completed when the prototype is finished. From that point, the records can be transferred and carried on to the other phases as printed copy, on a flexible disc for another 64000 System station, or across the RS-232 port to a large, mainframe computer.

Benchtop Applications

Not every project related to a digital product requires a team of designers. Many applications for logic instruments involve a single technical person, or several people who need the instruments only occasionally. For these uses, a benchtop instrument or a stand-alone unit is the best solution. Servicing products in remote locations is best accomplished with a portable analyzer. Modifying an earlier design in part is often a project assigned to a



Benchtop logic analyzers provide state, timing and performance analysis for troubleshooting and optimizing digital systems in the laboratory and at remote sites.

single engineer. A separate, stand-alone development station in production gives the manufacturing area access to the common data base used in the original development of the microprocessor product. Despite the growing need for instrument systems to support team projects, there remains a large number of applications that are better suited to stand-alone instruments and benchtop logic analyzers.

Design, Debug and Troubleshooting

When phrases like "cost effective," "productivity improvement," and "benefit analysis" have real meaning to the engineers in the lab, as well as accounting people, it is important to take note of the powerful measurement sets available in benchtop analyzers. Logic analyzers are well established tools for designing and troubleshooting general logic circuits and microprocessor buses and control lines.

The recently introduced HP 1630A/D Logic Analyzer provides state, timing, and performance, analysis plus interactive state/timing analysis. Any of the 64000 development stations with dual, flexible disc drives can be used as stand-alone instruments. They can be set up as extremely powerful benchtop logic analyzers by installing any combination of analysis subsystems, including software, hardware, and performance analyzers. The installed analyzers may be used separately or interactively. Logic analyzers provide a window on target system execution with a nonintrusive, real-time view of activity on system buses and control lines.

Logic analyzers complement the development system. Once the major part of a development program is completed, a benchtop logic analyzer can be used for the last few bits of fine tuning, leaving the development system free for use in the next program. Test routines defined earlier can be executed using stand-alone analyzers in production, quality control, or service at remote sites.

For hybrid logic circuits not related to a microprocessor, a stand-alone logic ana-

lyzer is an excellent troubleshooting tool. Either the 1630A/D or a 64000 logic analyzer is appropriate for these applications.

One-Station Development Projects

Model 64110A or Model 64100A Option 041 Development Station can operate independently from the dual flexible disc drives. The larger station with 10 option card slots could support an emulator, timing analyzer, state analyzer, and performance analyzer. The transportable station, Model 64110A, has five option card slots; it will support any of the 64000 subsystems, but, typically only one or two subsystems may be installed at the same time. Either station can serve as a benchtop development "system" providing a single designer all the tools needed to create a microprocessor-based product.

Computer Links

Development stations for the 64000 System can be used as terminals for compatible, large, mainframe computers. Files may be uploaded or downloaded from the computer across the RS-232 link. The development station may be used passively as one more terminal to enter files into the computer for storage or data processing. Emulation or analysis data may be transferred to the computer, using the computer's utility programs for more extensive statistical analysis.

A common application is to use the 64000 station for emulation and logic analysis for code written with a software development system that is resident on a computer. Since the need for software development preceded the introduction of microprocessor development systems, some organizations wrote their own programs for software development on computers. With the development station as a terminal, it is possible to retain the established, familiar software development aids and still access the advanced emulation and logic analysis capabilities of the 64000 Logic Development System.

Beyond Development

Applications for logic analyzers and the development system are not restricted to the

laboratory and R&D settings. There are many uses for logic instruments in production and in the field.

Production

Production conforms to a different set of constraints and pressures than those in a lab. Speed, automation, and efficiency are paramount concerns. The 64000 System is at home in production, too; the common data base and convenient, friendly development station serve to smooth the transition from prototype to production. Logic analyzers with HP-IB interfaces are combined with external controllers as part of automated testing and monitoring systems. Off-line, logic analyzers are used to troubleshoot faulty units.

Inspection and Quality Control

Inspection and quality control departments make judgments about a product's performance against two sets of criteria: (1) the specifications established by the design team, and (2) the standards imposed by the marketplace. Ideally, the standards desired by the end user are a subset of the standards set by the designers; but, in either case, the work of inspection and QC is easier and more effective when they have a full history of the product from the teams that developed it. For products developed on the Logic Development System, this history is present on the common data base. Department work loads determine whether a 64000 System cluster or an independent, flexible disc-driven station is the best solution.

Logic analyzers are important tools in verifying performance of any logic products. Nonintrusive, real-time monitoring allows inspection and quality control people to do more than just accept or reject end products. Cost savings result when rejected products can be classified by failure type and degree, since many products can be made acceptable with only minor fixes. A strong inspection and quality control program also uncovers production line problems early, avoiding costly, high rejection rates, or the even more costly failures at customer sites.

Field Testing

Service personnel often have the responsibility of generating tests and troubleshooting algorithms that are eventually used in the field. Service people also benefit from the documentation and information stored in the 64000 System data base. In the field, portable logic analyzers perform the tests and execute the algorithms that developed along with the product. The analyzers may be used as stand-alone units, or linked to a central controller or 64000 System.

Updating Products

It is often practical, and sometimes necessary, to redesign existing products around new components. On one hand, there is the advantage of having all of the basic problems defined and solved. On the other hand, there are the disadvantages of being bound by the constraints of the earlier design. Sometimes, the update is simply a matter of exchanging the old component with a new one. But, when simple swapping is not adequate, the redesign team needs the same design aids and tools required for the original design.



64000 Logic Development

Introduction

Model 64000 Logic Development System is a universal development system that supports the design and development of microprocessor-based products. Primary functions available with a 64000 System are software development, emulation, and state, timing, and software performance analysis. A broad selection of design support tools are available for many popular microprocessor families. Support tools tailored for specific microprocessors include emulators, assembler/linkers, Pascal compilers, C compilers, and logic analysis preprocessors. The 64000 System is not limited to applications for supported microprocessors; many of the functions, such as the editor, are general purpose, and user-definable tools are available to create new emulators, assemblers, or preprocessors.

Each 64000 System is configured to meet current needs. For programs requiring a team of hardware and software designers, the system can be established as a cluster of up to six development stations sharing a hard-disc memory and high-speed printer. If a computer-based software development tool already exists, a 64000 development station can interface as a terminal to the computer, and also serve as an active emulation and/or logic analysis station. A single station can be fully outfitted with logic analysis subsystems to provide a very sophisticated benchtop logic analyzer for use in the lab or in the field.

Measurement power provided by the various subsystems are all accessed from the development station keyboard and implemented with directed syntax softkeys. New 64000 System users become proficient quickly. With the flexibility possible through the broad base of support tools, the 64000 System facilitates all phases of microprocessor-based product development, resulting in a better product that goes to market earlier.

The Development System is a continually evolving set of compatible design aids and instruments. A continuing growth to keep pace with the needs of the digital domain industry is possible because of the sound foundation of the 64000 System architecture.

System Architecture

The fundamental unit of a 64000 System is the Development Station. Flexibility of the system architecture exists across two dimensions: between stations and within stations.

Between stations, there are three basic setups for the development stations. Up to six stations may be combined in a cluster arrangement, sharing a high performance hard-disc memory and printer. Since each station has a host CPU, the cluster operates as a distributed network. Distributed processing adds the speed and power of a CPU as well as the extra capacity of the hard disc, without a decrease of responsiveness when new stations are added. A second alternative is using the development station as a terminal to a large mainframe computer. In this mode, the station usually contains one or more of the 64000 subsystems for emulation or logic analysis. A third setup is as a stand-alone station for benchtop or field applications. As a stand-alone unit, the station is operated from dual flexible disc drives in the station. The drives are standard in Model 64110A Development Station, and may be added to Model 64100A Development Station with Option 041.

Within the station, the multiple bus structure is a notable architectural feature. The operating system and station CPU communicate with the option-card slots via the development station bus. This bus carries address, data, and control signals from the host CPU and supplies power to all option cards. Cards which comprise a distinct subsystem, e.g., an emulation subsystem, communicate via separate high-speed subsystem buses. Another bus, the intermodule bus (IMB) is the link for interactive analysis modes. Since buses are not shared, the host system does not intrude on emulation or analysis operations to conduct "housekeeping" tasks, allowing real-time run modes and multitasking for the subsystems.

Functions for each development station are defined by the subsystems installed in the station. Subsystems reside on cards, and a single subsystem may require from one to five cards. Operating software is stored on the mass storage device used for the configuration, and stations sharing common memory can all access the stored software. For



LOGIC ANALYZERS & DEVELOPMENT SYSTEMS

Logic Development System

Model 6400 (cont.)

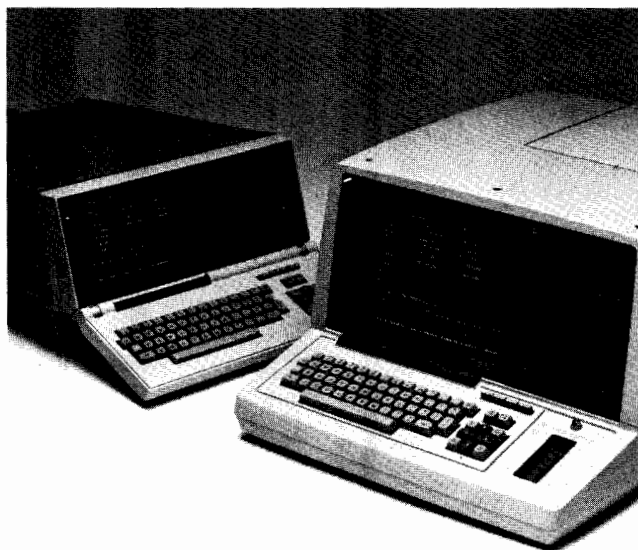

Two versions of development stations are available for the 64000 Logic Development System, Model 64110A and Model 64100A, to suit a variety of application settings.

example, in a cluster arrangement, all stations in the cluster can use any of the assemblers and compilers stored on the cluster's mass storage device.

New products for the 64000 System are compatible with existing 64000 Systems that are maintained or updated to current status with Software Subscription Service. As applications change, the user can reconfigure a 64000 System to meet the new needs. On-going compatibility allows users to take advantage of enhancements and new subsystems as they become available.

Versatility of the 64000 Logic Development System architecture supports tailored combinations of design and development tools for today's applications while leaving open the options for tomorrow's tools. The 64000 System is a long-term investment that keeps pace with changing industry needs.

Development Stations

Development stations are the user's interface to the 64000 Logic Development System. There are two stations, Model 64100A Development Station and the smaller, transportable Model 64110A Development Station. In use, the two stations are functionally the same, with an ASCII keyboard and eight syntax-driven softkeys to operate the installed subsystems. Each station contains:

- High-performance, 16-bit host processor
- Resident ROM and RAM memories for the 64000 station CPU
- Card cage with five or ten slots for subsystem option cards
- RS-232-C (V.24) interface to access other clusters or computers

Model 64100A Development Station has ten slots to accommodate subsystem cards. An optional PROM programmer can be installed directly in the station, to the right of the keyboard; specific interfaces are available for most of the commonly used PROMs. Local mass storage can be added with Option 041 Dual Flexible Disc Drives. At least one station in a 64000 System cluster must have local mass storage as a means of entering operating software for the system and any subsystems. Local mass storage frees the station for stand-alone applications, and it also provides a convenient, economical means of storing and transferring work in progress.

Dual, flexible disc drives are standard for Model 64110A Development Stations. The transportable 64110A station has adjustable legs and a hinged keyboard, which makes it a logical choice for field and stand-alone uses. HP 64110A has five option card slots.

Software Development

As hardware components for microprocessor-based products become more complex and powerful, the task of creating software to coordinate the hardware elements becomes increasingly important, in



Emulation subsystems support a variety of 8-bit and 16-bit microprocessors, an important set of development tools for the development of processor-based products.

both magnitude and impact. The Logic Development System offers the tools and convenience valued by software designers.

- Directed-syntax softkeys for quick entry of measurement setups
- Sophisticated, easy-to-use editor
- Assemblers for 8-bit and 16-bit microprocessors
- Pascal and C compilers for high-level language programming
- Linkers to combine code modules from any compatible source

Software development tools of the 64000 System make good programming practices easy. For example, when an error is found, a programmer can amend the code segment at the source code level with a few keystrokes, avoiding the problem of the code "patch" that fails to be entered in the main body of the program.

Editing code and text is simple with the sophisticated, screen-oriented editor function. Since software designers typically spend 50 percent or more of their time in editing, any time saved in editing has a major impact on meeting project deadlines. Editor functions are transparent to the user, but a status line on the display keeps the user informed about what is happening. Characters, lines, or entire blocks of code are added or deleted with equal ease using softkeys, overwriting, or special function keys.

Assemblers are available for a wide variety of microprocessors, or the user-definable assembler can be used to construct a special table-driven assembler for other microprocessors. Assemblers are loaded into the system mass storage from flexible disc. Once on the system, an assembler can be called into the station's host memory quickly with softkey commands.

High-level languages use less programmer time as they usually require fewer lines of source code. HP 64000 System compilers for Pascal and C languages are available for many popular 8-bit and 16-bit microprocessors. Compilers translate the C or Pascal source lines into relocatable object code for the target microprocessor.

The high-speed linker is a key element of the efficient programming tools of the 64000 System. A linker unites diverse modules into a single program. Modules may be relocatable assembly modules, compiled high-level language modules, and external library files. For example, when code space is restricted or more direct control is needed for a hardware unit, many software designers prefer to program some code modules in assembly language for more efficient use of code space. The high-speed linking capability frees the software designer to program at any level, using the most effective language for each component code module.

After software is written and tested, PROM programmers convert the software into firmware. When adding a PROM programmer to a 64000 System, the programmer hardware is installed directly in the 64100A Development Station, and the control card occupies one of



the option card slots. Interface modules are available for most of the commonly used PROMs. A PROM programmer is a convenient option for downloading software to firmware right at the development station.

Software development flows quickly because the 64000 System is well adapted to the software designer's needs. The designer can concentrate on the design task rather than on any constraints of the design tools.

Emulation

Emulation is a valuable design tool throughout most of the steps of creating microprocessor-based products. Emulation has become a standard technique for evaluating and debugging both hardware and software during all stages of developing a microprocessor system. An emulator should conform to the characteristics, operating modes, and specifications of the processor it supports. The 64000 Logic Development System offers emulation subsystems for a variety of 8-bit and 16-bit microprocessors. Presently, emulators are available for the following processors:

8048	NSC800	6802
8049	Z80	6803
8080	Z8001	6805
8085	Z8002	6808
8086	6800	6809
8088	6801	68000

For microprocessors that are not presently supported with a dedicated 64000 System emulator, a custom emulator can be developed using Model 64274S User-Definable Emulator as a base. For ROM-based systems, there is a ROM Emulator, Model 64272S, to provide a controlled environment for software execution and analysis. Both user-defined emulators are powerful alternative tools for applications not served by processor-specific 64000 System emulators.

Emulation allows the designer to check software execution even before user-system hardware exists. Features of 64000 emulation subsystem meet the needs of hardware and software engineers.

- Real-time emulation mode without inserted wait states
- Run-time controls for single cycling and register display
- Mapping memory blocks to emulation or target memory
- Simulated I/O using 64000 System resources
- High-speed emulation memory

Software modules can be evaluated as they are developed, rather than after both hardware and software are totally complete. Since much of the debugging is done as modules are added, there are far fewer problems in integrating hardware and software.

Emulation subsystems for the 64000 System consist of a control card and an emulator pod assembly. Memory for the emulator, ordered separately, requires at least two slots in the development station card cage, one for the control card and a second slot for the memory card. Emulation memory is implemented with high-speed static RAM; up to 1 Mbyte of emulation memory may be installed in increments of 32, 64, or 128 kbytes.

The emulation processor is run from two memories: emulation memory and target system memory. Memory is assigned to either memory by blocks of memory address space, but the processor runs as if only one memory existed. Blocks of memory addresses may be designated as RAM, ROM, or illegal. As code modules are completed, they can be tested on the emulator in combination with existing target system hardware. When a code module has been tested and debugged, it can be downloaded to a PROM and placed in the system under development.

One of the important advantages of an emulator is the control over the microprocessor during the development phase. The microprocessor can be run, halted, or single-stepped from the development station keyboard. During emulation, it is possible to examine the contents of the microprocessor memory and registers, modify the contents, and then continue the emulation run.

An internal analyzer may be added to the emulation subsystem to monitor activity on the emulator bus. Model 64302A analyzer provides real-time traces of address, data, and status/control signals. Displays may be in the mnemonics of the microprocessor or in an appropriate numerical base.

EVENT	COUNT	ABS COUNT	PERCENT	RELATIVE		Confidence Level: 95%	Error Tolerance: 5%
				MEAN	STD DEV		
INITIALIZE	113,390	13,423,739	18	12.89	50.37		
GET_NEXT_TOKEN	289,294	13,423,657	46	32.20	80.09		
APPLY_CONTROLLE	150,621	13,424,318	24	17.12	21.16		
CALCULATE_ANSWER	69,412	13,419,697	11	7.89	31.42		
TOTAL COUNT:	616,717						

STATUS: Awaiting command userid BRCSAM 20:18

..show current_measurement event_data_list

..define ..setup ..measure ..execute ..show ..copy ..configure ..end

Software performance measurements collect the statistics needed in benchmarking and optimizing total system program activity.

An emulation subsystem may be used interactively with other functions resident in the same development station. Analysis and emulator subsystems associated via the Intermodule Bus (IMB) can be operated in cross-arming and cross-triggering modes. Combining emulators with the IMB across the internal analysis cards simplifies development and debugging in multiprocessor applications. An emulator and analyzer combination adds convenience and measurement power. Three sophisticated analysis subsystems are available—Model 64600S Logic Timing/Hardware Analyzer, Model 64620S Logic State/Software Analyzer, and Model 64310A Software Performance Analyzer.

Before emulators became widely used, many of the functions available through emulation were achieved with software techniques. By comparison to present-day emulators, these techniques were incomplete and intrusive. Emulators became popular quickly because they are easier to use, offer more features, and save valuable designer time. The 64000 System emulators add one more dimension of user friendliness—all emulation commands are entered with directed-syntax softkeys from the development station keyboard.

Software Performance Analysis

Model 64310A Software Performance Analyzer provides overview measurements to aid in evaluating total system effectiveness of programs operating in real time. Global measurements let the software designer determine where system resources are being used, in terms of execution times, memory usage, and interaction traffic. Software performance measurements aid in determining where to focus optimization efforts for maximum effect on system performance. The Software Performance Analyzer monitors the emulation bus, and can be applied even before the target system hardware is available.

- Histogram displays for quick comparisons of software activity
- Tabular displays with continually updated means and standard deviations on current measurement
- Measurement modes of memory and program activity
- Measurement modes of event duration
- Measurement modes of intermodule linkages
- Monitor up to 12 events with scanned sampling
- Real-time measurement of two events for each installed software performance analyzer

Model 64310A analyzer is used with any of the processor-specific emulators for either 8-bit or 16-bit microprocessors. Up to three Software Performance Analyzers may be installed in a single station and they may be operated interactively through the intermodule bus (IMB). Each analyzer occupies one card slot. Software performance analysis is a powerful analytical tool once reserved for large mainframe computers, and now available for developing microprocessor products.

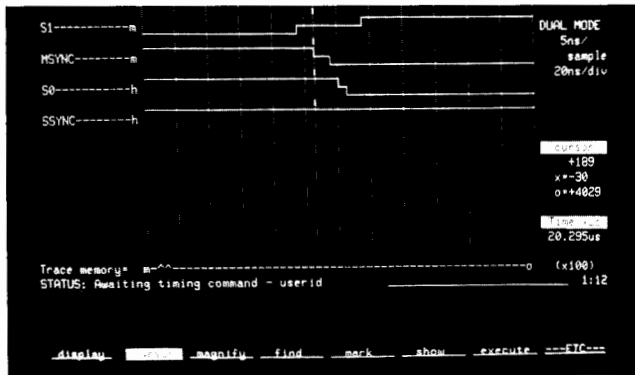

The dual threshold mode for 64600S Hardware Analyzer has a three-level display that shows when the signal voltage was between the specified maximum and minimum values.

Logic Timing Analysis

Model 64600S Logic Timing/Hardware Analyzer with 8 or 16 input channels provides very sophisticated timing analysis measurements for asynchronous system activity. Traditionally, timing analyzers were considered tools for hardware engineers, but the 64600S analyzer with softkey operation and plug-in connectors make the timing measurements accessible to a wider range of designers and troubleshooters. The 64600S Hardware Analyzer offers powerful analysis that is easy to use.

- Four measurements modes to suit a variety of applications
 - Wide sample mode to 200 MHz for typical timing measurements
 - Fast sample mode to 400 MHz for more detailed timing analysis
 - Glitch mode to locate intrusive glitches as narrow as 3 ns
 - Dual threshold mode to check for marginal signals
 - Versatile triggering parameters to locate the trace quickly and accurately
 - User-defined labels for easy identification of displayed signals
 - Memory depth of 4060 samples in standard mode, 8140 samples in fast sample mode
 - Postprocessing functions for extended analysis capability
- Model 64600S analyzer aids in quickly resolving timing problems in multichannel logic systems.

The Hardware Analyzer consists of a control board and one or two 8-channel data acquisition boards. Data probes, one 8-channel probe for each acquisition card, are included. A Hardware Analyzer may be installed in a development station in a cluster or in a stand-alone station. Several Hardware Analyzers may be used interactively for extra input channels suitable for multiple bus applications.

Each measurement mode provides a different view of the system under test. Wide sample mode is the most frequently used mode for standard timing analysis measurements from 2 Hz to 200 MHz. Maximum resolution is 5 ns, which includes 1.5 ns of skew. Memory is 4060 samples deep. The other three modes use resource sharing to achieve additional power; one-half of the installed channels are traded off when fast sample, glitch capture, or dual threshold mode is evoked. Fast sample mode captures asynchronous events at rates up to 400 MHz, and stores them in a memory 8140 samples deep. At these speeds, first-level parametric measurements are feasible. In glitch capture mode, a separate glitch detection circuit is activated whenever a signal crosses threshold two or more times in the same sample period resulting in completely asynchronous glitch monitoring. Glitches are displayed uniquely as dashed lines on the timing trace or noted with a "g" on the corresponding word listing. Dual threshold mode displays are three-level waveforms that show when the signal is above, below, or between threshold levels. This mode identifies marginal signals and slow transitions which are frequent causes for intermittent hardware problems.

Labels for single input lines or groups of lines identify the input source for easier interpretation of the display. Once defined, these user labels are added to the softkey set, making measurement setups and analysis much more convenient.

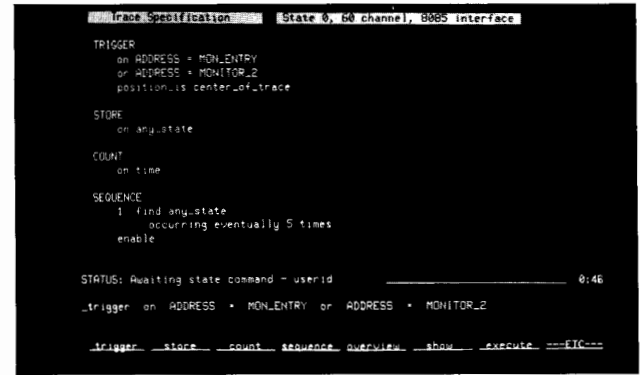

Very complex measurements may be set up quickly on the 64620S Software Analyzer using the convenient syntax-driven softkeys.

Speed, memory, and measurement modes give the Hardware Analyzer its power, but the finesse is a function of the versatile triggering parameters. Pattern triggers are specified in binary, octal, or hexadecimal. A Boolean NOT condition of a specified pattern triggers a timing trace when the signals deviate from that pattern. Occurrence of a glitch on one or more lines can serve as a trigger condition, or a glitch can be combined with a pattern specification in logical AND or logical OR conditions. Patterns may contain "don't care" entries on one or more bits. Transition triggering establishes a trigger point as a set of signals enter or leave a defined state. Time interval specifications can be defined for patterns, and the analyzer is triggered if the pattern persists longer than the defined time or if it does not persist long enough. When 16 channels are available, a trigger on inputs of one probe pod can arm the analyzer to search for another trigger specification on the second probe pod, a powerful sequential triggering capability.

Postprocessing features apply to stored timing measurements. Like all 64000 System functions, the postprocessing functions are executed with softkeys. The capability of storing and retrieving timing measurements quickly and simply is an enabling function for the other postprocessing functions. Find and mark functions can locate and indicate the occurrence of a specified pattern across the entire 4000 or 8000 sample measurement, far more accurately and in much less time than if the same procedures were done manually. All occurrences of a marked time interval can be measured and the mean calculated automatically, resulting in a more accurate reading of the typical time interval. New measurements may be compared to a stored measurement for automatic testing processes. Timing displays can be translated directly into state listings, together with the marked conditions and time interval measurements. In a two-step process, the analyzer can collect traces from one set of trigger specifications, pass the trace to the postprocessing functions where a second set of trigger specifications determines whether the trace is stored or discarded. Postprocessing functions are implemented by the 64600S Hardware Analyzer operating software, and are available on all analyzers shipped after August, 1983; the same postprocessing functions may be added to earlier 64600S analyzers by simply updating the subsystem operating software.

Logic State Analysis

Model 64620S Logic State/Software Analyzer offers real-time, transparent software analysis for microprocessor systems. A modular system, the Software Analyzer can be configured for 20 to 120 input channels. The 64620S analyzer supports analysis at all levels of complexity for microprocessor systems.

- Multiple trigger parameters using symbols, ranges, NOT, and "don't care" terms as well as file names and line numbers
- Selective data storage for edited state listings
- Powerful 15-level sequencer that may also be used to form one or two measurement windows
- Extensive symbolic tracing for quick measurement setups and easy interpretation

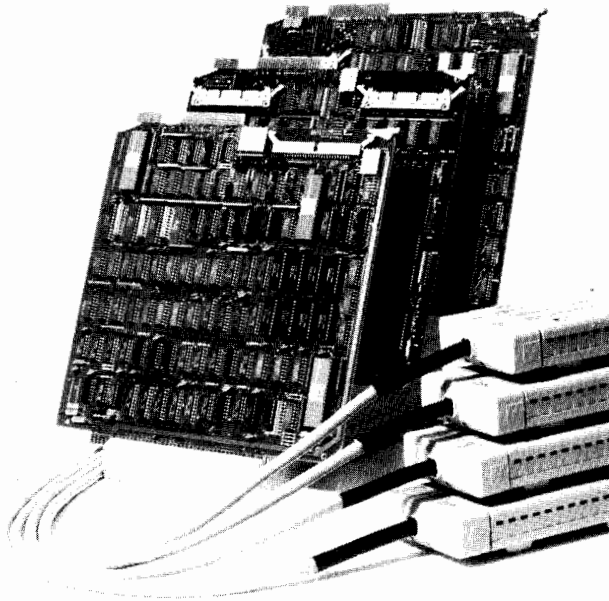

Basic hardware for 64000 subsystems resides on option cards. New subsystems can be added to a Development Station as needed.

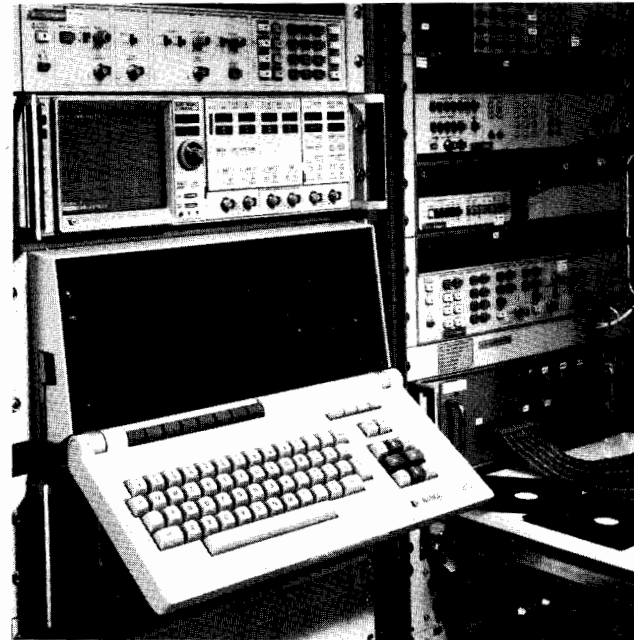

The 64110A development station may be rack-mounted; the adjustable keyboard can be set at any convenient angle for easy access.

- New, real-time, nonintrusive analysis feature set now supports debug for high-level programming languages
- Two software performance overview modes for code optimization
- Processor-specific interfaces and inverse assembly for easy hook-ups and state listings in the microprocessor mnemonics

The HP 64620S Software Analyzer subsystem is composed of a control card, one to three data acquisition cards, and general purpose probes or dedicated interfaces. There are two types of data acquisition cards: a card with 40 input channels and a card with 20 input channels and the overview circuits. The analyzer collects and stores data at data transfer rates up to 10 MHz. Analyzer memory is 256 states deep, with a 4096-state memory for the overview function.

Flexible triggering, a major strength of the Software Analyzer, is implemented with shared resources between trigger, store, and count functions. For example, if all resources are devoted to the trigger function, up to eight ORED parameters can be used to define the trigger point. Trigger parameters may include values, ranges, "don't care" terms, NOT terms, file names, symbols, and line numbers. Storing monitored states may be set to begin before, after, or around the trigger point. Events stored may include all states, or may be limited to only states of a specified type or within a defined range. Event or time interval counts can be made between stored states or from the trigger point to each stored state.

A sequencer may be used in conjunction with the trigger, store, and count functions. When the sequencer enables the trigger function, conditions specified for the sequencer must be met before the analyzer initiates a search for other triggering conditions. A basic sequence specification may have up to 15 sequence terms. Restart terms may be used with one or more of the sequence terms to define a state that reinitiates the search for a portion or all of the sequence. Sequence terms may also be used to define enable/disable pairs that form "windows" for other functions in the analyzer; up to two windows may be specified for measurements restricted to specific code modules.

At the highest level of analyzer control, the master enable condition enables or disables all other analyzer functions. The master enable may be a specific event, a sequence, or a stimulus from another analyzer across the intermodule bus.

Symbolic tracing is based on the symbol table created by the linker. Other user-defined labels may be added as needed. Symbols are alphanumeric names assigned to absolute addresses, ranges, or procedure names. All entries in the symbol table become part of a softkey set, saving time in setting up measurements.

An extensive feature set has been added to the Software Analyzer to accommodate analysis of code written in high-level languages. Enhanced logic analysis feature sets for both the 64600S Hardware Analyzer and the 64620S Software Analyzer require an expanded host memory included in more recent development stations, or added with Model 64032A Memory Expander board for stations with serial numbers below 2309A.

Programs generated on the 64000 System link code modules written in absolute, assembly, and compiler languages. With the enhanced feature set, the 64620S analyzer accommodates analysis of any combinations of languages simultaneously. Command files can be executed in the analyzer providing macro capabilities for analysis setups and measurements.

Many of the new features are direct aids for troubleshooting high-level code. For example, the display may be as wide as 15 fields with up to 64 characters in a field. Off-screen fields are moved on-screen with left and right roll keys. An analyzer trace may contain source line numbers, high-level instructions together with comment fields, and assembly language lines. Symbol table entries may include "don't care" bits for more flexibility in setting up measurements.

Preprocessors and inverse assemblers are available for a variety of microprocessors. Displays are automatically formatted and state listings are translated into the microprocessor mnemonics for convenient measurements. Refer to page 167 for a description of the interfaces available for specific microprocessors.

Intermodule Bus

An Intermodule Bus (IMB) is available to connect two or more analyzers residing in the same development station. With the IMB, one analyzer can trigger or arm another analyzer for interactive applications. Subsystems that can be used with the IMB are the Hardware Analyzer, Software Analyzer, Model 64310A Software Performance Analyzer, and either internal analyzer used with an emulator (Model 64300A or 64302A).

Combining subsystems for interactive operation is useful for many applications in both developing and troubleshooting microprocessor-based products. Interactive state and timing analysis simplifies the task of integrating hardware and software. For multiprocessor systems interactive emulator analyzers aid in correlating activity between the emulators. When more than 16 input lines for a timing analyzer are desirable, the IMB can combine two timing analyzers. The IMB allows the user to take full advantage of the 64000 System tools for more efficient troubleshooting and development.

LOGIC ANALYZERS & DEVELOPMENT SYSTEMS

Logic Development System

Model 64000 (cont.)



Model 64000 Logic Development System offers total support for all phases of developing microprocessor-based products.

Summary

Model 64000 Logic Development System is a complete system for developing microprocessor-based products. From the very first outlines for design specifications, through delivery to the customer, through modifications and updates, the 64000 System provides a common data base accessible by everyone associated with the product. Engineers and technicians working with the new product don't have to guess what should happen on the basis of out-of-date listings, inaccurate after-the-fact flowcharts, and scanty notes. They know. Final code and complete documentation can be passed on with the product as it moves to completion. Since there is a common user interface for all processes, there is no need to adapt to a new instrument for each major development phase. As an implementation of the "electronic workbench" the 64000 System supports microprocessor products through all phases of design, development, production, test, and redesign.

The HP 64000 System offers full microprocessor support: emulators, assemblers, C compilers, Pascal compilers, tailored for a wide selection of 8-bit and 16-bit processors. For debugging, integrating, and optimizing, four analyzers provide real-time, nonintrusive measurements to quickly locate problems and bottlenecks. The 64000 System is an integrated set of compatible tools that support microprocessor development from concept through obsolescence.

As a universal system, the 64000 System frees the user to select the optimum processor for each new product. With a dedicated development system, a processor is chosen first, and then support instruments are chosen to match the processor; economy may dictate that the same processors be used for subsequent products, forcing the designer to fit later applications to existing support equipment. Tooling up for a new microprocessor project with the 64000 System solution is a moderate add-on expense because the fundamental support already exists in the development stations, hard disc or flexible disc drives, and printer. With the universal 64000, it becomes practical to consider two or more processors, and even make comparisons through some breadboarding phases, before selecting the processor that best suits the application. Multiprocessor applications become feasible, even when the microprocessors come from different vendors. When a mi-

croprocessor is not supported by any of the 64000 development aids, user-defined kits are available to create new processor-specific emulators, assemblers, and inverse assemblers.

The 64000 is a friendly system, friendly in many dimensions. New users become proficient in little time, typically less than a day, and experienced users progress quickly to take full advantage of the advanced applications of the 64000 System. The 64000 System responds rapidly, due to distributed processing. Details of routine tasks are performed by the system, not the user. Yet, none of the functions are hidden; the display status line always describes current system activity, and error messages and commands are fully spelled out. Softkeys as implemented in the system are virtually self-explanatory; frequent references to manuals to decipher a code are eliminated. With softkeys, typing is used to create new code and text, and not for entering commands. Directed syntax displays the possible choices for the next command and avoids the inconvenience of entering a command string in the wrong sequence. Model 64000 Logic Development System encourages users to practice sound design and development techniques.

Open-ended architecture and modular structure add another dimension of flexibility. A 64000 System can be purchased in functional units and enhanced across time. The obvious advantage is that capital equipment expenditures can be spread across several budgets even while the lab has the tools that are needed immediately. A typical approach is beginning with a small cluster of two or three development stations, printer, hard-disc memory to support foreseeable growth, and one or two emulators. A Software Performance Analyzer is added a bit later, and full logic software and hardware analysis is added even later when the project is sufficiently complete and analysis is more critical. As new projects come on-line, more stations and new emulators are added. Another approach is to begin with one or two transportable 64110A stations, together with an emulator and logic analysis subsystems. By adding functions and stations as they are required, 64000 System users take full advantage of the resources they need without maintaining extensive apparatus that lies idle because it is not immediately applicable.

Selecting a Logic Development System

Model 64000 Logic Development System is complex and dynamic family of microprocessor support tools. Consequently, it is recommended that an HP Instrument Sales Representative be contacted for suggested system configuration and applications. Prices for selected components are listed below.

Ordering Information

64100A Development Station

Opt 041 Dual Flexible Disc Drives

64110A Development Station with Flexible Disc Drives

64156S 32k byte Emulation Memory Subsystem

642XXS Emulation Subsystem, 8-bit μ P

642XXS Emulation Subsystem, 16-bit μ P

64302A Internal 48-channel Logic Analyzer for Emulator Bus

64310A Software Performance Analyzer

64500S PROM Programmer

Opt XXX PROM-specific Interface

64600S Logic Timing/Hardware Analysis Subsystem, 8 channels

Opt 010 16 channels

64620S Logic State/Software Analyzer Subsystem, 20 channels and overview

Opt 010 40 channels

Opt 011 60 channels and overview

Opt 012 80 channels

Opt 013 100 channels and overview

Opt 014 120 channels

64650A General Purpose Preprocessor

646XXA Processor-specific Interfaces for 64650A

648XXA Pascal Compiler, 8-bit μ P

648XXA Pascal Compiler (16-bit μ P) or C Compiler

648XXA Assembler/Linker, 8-bit μ P

648XXA Assembler/Linker, 16-bit μ P

64651A User-Defined Assembler

64656A User-Defined Inverse Assembler

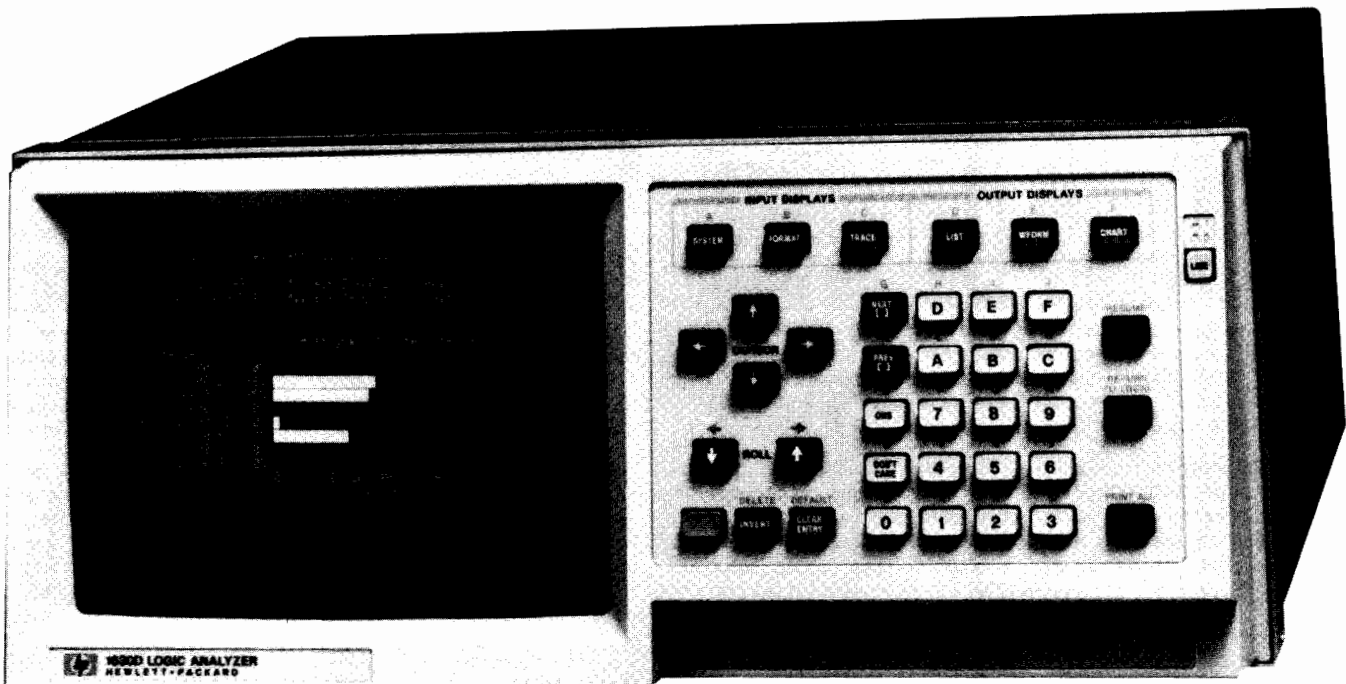

1630D



1630A/D Description

Model 1630A/D Logic Analyzer combines four logic analysis functions in one benchtop instrument. The 1630A/D can become your single most important tool for logic design, development, and testing.

- Timing analysis at 100 MHz to check hardware and status signals
- State analysis at 25 MHz to trace program and software flow
- Performance analysis to optimize code
- Interactive state/timing analysis to integrate circuits and code

Newest of the HP stand-alone analyzers, Model 1630A/D has the added performance and measurement power that makes it ideal for any digital designer or troubleshooter who works with small systems.

Standard, built-in HP-IB and HP-IL interfaces accommodate a wide variety of low-cost accessories and peripherals. Printer-plotters provide hardcopy for documentation. External memory speeds setup and stores accumulated data for later reference. With an external HP-IB or HP-IL controller you can add the 1630 analyzer to a larger test and measurement system, run the analyzer remotely, or automate production line tests. A probe interface has microprocessor-specific modules and inverse assemblers to generate measurements in the mnemonics used in processor-based systems.

In any mode, the 1630 analyzer is easy to use. Measurement parameters are entered quickly using the interactive menus. You can label input lines and addresses for easier interpretation, with five-character alphanumeric names you select.

Model 1630A Logic Analyzer has 35 input lines, of which 8 lines may be used for timing analysis; Model 1630D has 43 input lines and either 8 or 16 lines may be used for timing analysis. A 1630A analyzer can be upgraded to Model 1630D easily. Flexibility, high performance, and reliability at an economical price make the 1630 an excellent value for your logic instrument investment.

Timing Analysis

- 8 or 16 (1630D) input channels to monitor signal-line activity
- Speed 100 MHz for functional measurements with 10 ns resolution
- Sophisticated, flexible triggering modes including glitch triggering and pattern-edge triggering
- Labels for quicker setups and easier interpretation
- Two cursors and automatic readings for interval measurements

Timing analysis is the province of the hardware engineer. Functional relationships of signals on the status lines are critical to system operation. With the 100 MHz internal clock, the 1630A/D timing analyzer performs many first-level parametric measurements.

A first consideration in selecting a logic timing analyzer is finesse of the triggering conditions. The capability to place the timing trace at a point of interest results in more efficient analysis. Timing trigger conditions for the 1630 A/D Logic Analyzer allow you to place a monitoring window where you want it. Trigger points may be specified by a pattern, a positive or negative edge (signal-line transition), a glitch occurring on any specified channel, a pattern and edges, or a pattern and glitches. The trigger point can be placed at the beginning, center or end of a trace, and a pattern duration specification defines how long a pattern must persist to be recognized as valid. A time delay to 9999 seconds can be inserted between the trigger point and the trace. Flexibility in triggering conditions assures that your measurements will be taken where you need them, and when you need them.

The waveforms of the timing display let you compare the activity on up to 16 status lines. Two cursors can be moved anywhere on the timing display, and the time interval between the two cursors is displayed automatically on the upper right corner of the screen. If you want to check a time interval to be sure timing parameters of your system are being met, you can move the two cursors together, keeping a constant time interval, while you compare successive transitions of related status lines. Magnification of the display from one to forty times and an adjustable sample period from every 10 ns to 500 ms let you make time measurements at any level of accuracy.

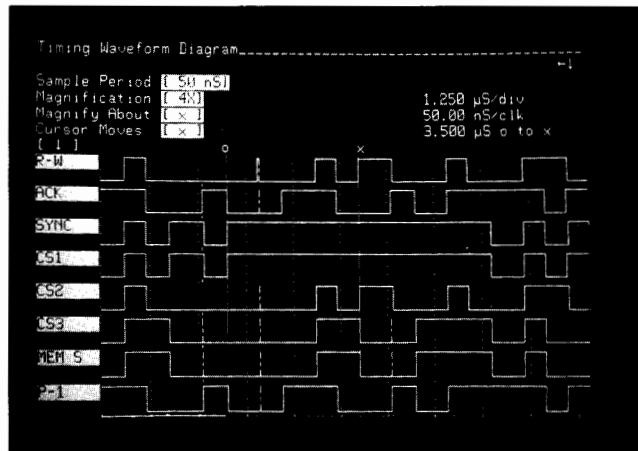

Timing waveform displays represent real-time activity at rates up to 100 MHz on up to 16 input channels. User-definable labels identify each input. Glitches are uniquely displayed as dashed lines. A direct readout of the time between the x and o cursors is displayed in the upper right corner.

You can alter the timing display for your convenience. You can name each line with labels up to five characters long. With labels indicating the function of each line being monitored, you avoid the bother, and the possible errors, of recalling the probing scheme when you run a measurement. Timing lines can be arranged in any order, and you can delete the timing lines that are not needed for the measurement in progress.

The timing waveform measurement can be translated directly into a numeric state listing with the LIST key. Labels can be defined for monitored lines, individually or in groups. Elapsed time from the trigger point is also shown for each sample state on the timing list. Numeric bases are typically binary, octal, or hexadecimal, assigned by label group, but you may select decimal base or assign ASCII mnemonics for values of sets of six or more bits.

Measurement power of the 1630 timing analysis function is a consequence of the basic feature set, with 100 MHz sampling speed, 1024-bit deep memory, and 16-channel width of the 1630D. But the value of the 1630A/D in actual application is the versatility and ease with which the analyzer can be configured to fit each analysis situation, to obtain accurate measurements that answer timing analysis questions directly.

State Analysis

- 35 or 43 (1630D) channels to trace state flow nonintrusively
- Speed to 25 MHz to accommodate data transfer rates in microprocessor and other digital systems
- Four trigger/qualifier resources to initiate state flow measurements and to edit the information to be stored
- 1024-word memory to support broad-sweep measurements
- User-defined labels to match input lines to processor system functions
- Compare mode to check measurement against known data
- Mark/show selected states to quickly edit state listing
- Three clocks for demultiplexed address and data signals
- Low-cost peripheral adds extra memory and inverse assembly for trace lists in the microprocessor mnemonics

As the components for digital systems become more complex and perform more functions that are transparent from the user's viewpoint, software becomes ever more critical to the smooth operation of a digital system. A major tool for software debugging and system integration is the state analyzer. State analysis with the 1630 analyzer lets you view real-time state flow nonintrusively.

State analysis with the 1630A/D analyzer is supported by a solid foundation of basic features: 35 or 43 (1630D) channels, 25 MHz speed, and 1024-bit deep memory for each channel. Width, speed, and depth assure that the 1630 analyzer is suitable for a broad spectrum of measurement applications. Beyond that, the software analyst needs features that support flexible definitions of where, when, and how the measurement is made.

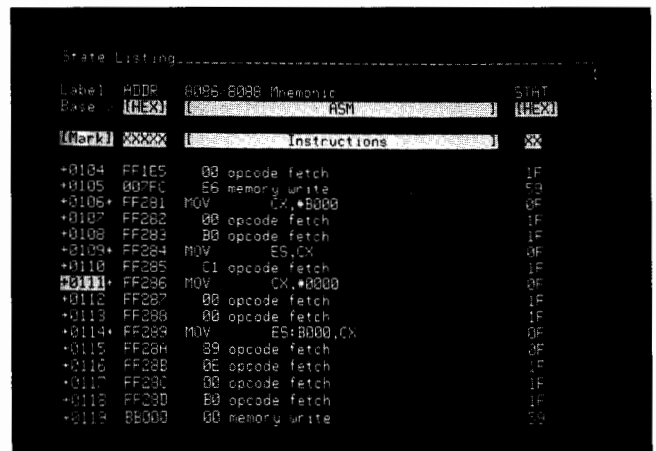

State listings may be translated into the mnemonics of the target microprocessor with the probe interface. Inverse assembly makes it easier to compare the state measurement to the source code listing, without the need to translate from a hexadecimal listing. State flow is monitored nonintrusively at rates to 25 MHz.

In state analysis, you can define up to four resource terms to set parameters for triggering, storing, and restarting the measurement. Resource terms may be used to define a sequence to be found before triggering and capturing a state listing trace. One or more resource terms may be used to define the conditions under which a search for a trigger point is terminated and a new search is initiated. Resource terms can also be used to qualify the states that are to be stored in the analyzer memory, such as storing only reads to memory. With the four resource terms, you can place a window on state flow, and "edit" the information to include only the data you need for analysis.

Labels can be assigned to groups of input lines for the state analysis mode, also. A total of eight labels may be assigned, each label name with up to five alphanumeric characters. Labels are the means of grouping the input lines, with the added convenience of mnemonics that are meaningful for your applications, such as ADDR, DATA, RD_W, etc. Once a label is assigned to a set of bits, that set of bits is treated as a single variable.

Further identifiers can be defined for a label set. Module names can be specified for up to eight contiguous address ranges or 16 contiguous ranges. Status names can also be defined for any label group of four or fewer bits. By adding a tape cassette drive and an interface, inverse assembly translates the state listings into the mnemonics for the microprocessor being used. Interfaces are available for many popular microprocessors.

Two alternative forms of the standard state listing offer other views of the collected data. From one to sixteen of the state inputs can be translated into a state waveform display. For a global view, the state listing can be transformed into a graph display. Typically, the graph is based on the addresses, plotting the magnitude of the address against the order of occurrence. A graph of system activity highlights inappropriate looping and any activity occurring in an illegal memory area.

Comparing new measurements with previous measurements is implemented with key events; you select and mark up to sixteen events anywhere in the 1024-event standard listing, modify them as necessary, and they will be compared to the comparable events in subsequent listings. You may elect to run the new measurement until the standard and current measurements either match, or fail to match. The compare mode adapts well for automated testing with an HP-IB or HP-IL controller.

Precise registration with flexible triggering, efficient data storage with store qualifiers, convenient displays with labeling and disassembly make the 1630A/D Logic Analyzer an excellent tool for your software design and debugging.

Interactive State and Timing Analysis

- Correlate synchronous and asynchronous measurements
- Resolve hardware/software problems
- 1630A has 27 state channels and 8 timing channels in the interactive mode

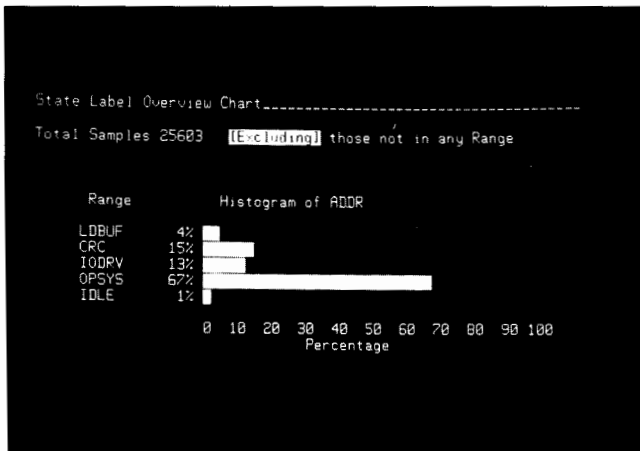

Histograms may be generated by event frequency or elapsed time for an overview of system flow. Up to eight label ranges or time intervals may be specified to analyze the impact of selected code modules on the total program execution. These modes support performance measurements to locate bottlenecks and inefficiencies.

- 1630D has either 27 state and 16 timing channels or 35 state and 8 timing channels in interactive mode
- State and timing analysis functions retain full feature sets in any mode

When the 1630 analyzer is used for interactive state/timing measurements, both analysis units continue to collect data simultaneously. Either function can arm the other function. For example, you can define a triggering condition for the timing analyzer, and set it to arm the state analyzer to trigger on any state. This, in essence, sets a timing trigger condition to initiate a state measurement. By tying the two functions together, you can relate a state flow problem to the occurrence of a glitch on a status line, or seek out a timing problem in a particular part of program activity.

Since hardware and software are usually designed in separate phases, and often by different people, the interactive measurement modes are most valuable when integrating the two subsets to create the final product. Software/hardware analysis quickly pinpoints problem sources, and you avoid multiplying your troubleshooting efforts.

Software Performance Analysis

- Two global overview modes for optimizing and benchmarking total program flow
- Histogram display for easy discrimination of comparative frequencies by occurrence
- User-defined labels for up to eight time or range categories for each measurement

Software performance analysis measurements provide a global view of your system's activity as it executes in real time. Each of the two measurements are based on a label group, selected from the label groups defined in the state analysis formatting. Events or time intervals are used to generate the histograms.

Performance analysis measurements let you see where your system resources of time and memory are being used, and then decide where changes are needed. Once you make your modifications, you can check to be sure the changes were effective.

Typically, the address label group is partitioned for performance analysis. If a program is failing to meet timing constraints or requires too much space in memory, you can compare the relative event occurrences for up to eight subroutines by entering the address ranges for each routine in the overview specification menu. The resulting histogram will show you the percent of events occurring in each subroutine. If you find one routine uses a large share of the execution time, it is a clear indication that minor adjustments in this subroutine could well have a major impact on total program efficiency.

A time interval histogram is used to investigate the execution time of a single subroutine. The bars represent the frequency with which the subroutine is completed within the time ranges; up to eight ranges

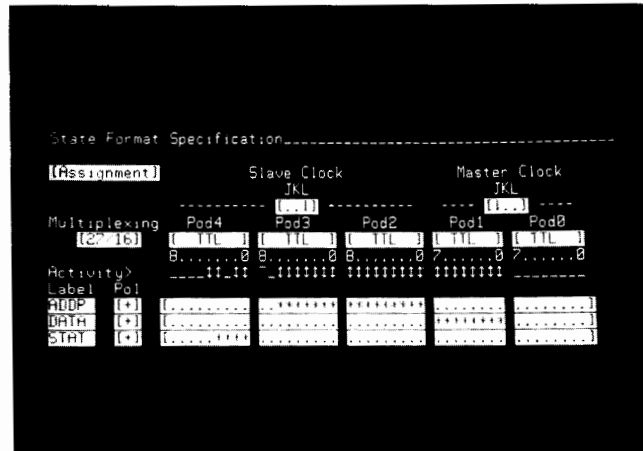

The state format specification defines the conditions for making state or performance measurements. A choice of either or both edges of three clocks and a master clock allow demultiplexing when needed. Up to eight user-defined labels may be assigned to designated groups of input bits for easier interpretation.

can be defined. Average, minimum, and maximum times and the number of samples are shown on each time interval histogram. This gives you a good idea of typical execution time for the subroutine, and highlights the atypical execution times.

Software performance analysis is a sophisticated tool for a benchmark analyzer. It offers a new view of operating software, module-by-module rather than word-by-word. With a broader overview, performance analysis is an excellent means to the end of modifying and revamping programs to fit in the more constricted memory and time resources available in many microprocessor applications.

Peripherals and Preprocessors

HP-IB and HP-IL interfaces are standard in all 1630 Logic Analyzers. The 1630A/D analyzer accommodates a variety of peripheral instruments for a number of applications. HP-IB printers and printer/plotters can provide hard copy for documentation and post-processing analysis. Any HP-IB external controller, or the handheld HP 41C can be programmed to operate the analyzer remotely and as an automated test instrument. An economical external memory is available with the HP 82161A Digital Cassette Drive.

The Digital Cassette Drive is also used with Model 10269A General Purpose Probe Interface. A family of interface modules are used with the Probe Interface to customize the 1630 for specific microprocessors. An inverse assembler on a minicassette tape is included with each interface module to translate the state listing measurements into the mnemonics of the supported microprocessor. A state listing in the language used for programming makes it much simpler to read the measurements and compare them to the written program. The interface also simplifies setting up the analyzer for measurement sessions, as the analyzer probes plug directly into the probe interface. Refer to page 167 for more information.

Model 1630A/D Logic Analyzer offers high performance for an economical price.

1630A/D Specifications

Memory

Data acquisition: 1024 words.

Compare: 16 words.

Memory search: all patterns within a label set may be marked or separately displayed.

State Analysis Mode

Clocks

Clock edges: for each of three ORed clocks, select either or both edges; separate edges of one clock may be selected for multiplexed modes.

Repetition rate, single phase: 25 MHz for single edge of single clock; 20 MHz for any combinations of ORed clocks and edges.

Repetition rate, multiplexed: master clock must follow slave clock by at least 10 ns and precede next slave clock by at least 50 ns.



LOGIC ANALYZERS & DEVELOPMENT SYSTEMS

State, Timing & Performance Analysis

Model 1630A/D (cont.)



Model 1630A/D Logic Analyzer provides timing analysis, state analysis and software performance analysis in a single, benchtop instrument.

Pulse width: ≥ 10 ns at threshold.

Setup time: ≥ 20 ns.

Hold time: zero.

Data Indexing

Resources: four terms, including the Boolean NOT of each term, ALL patterns or NO pattern; terms may be used as often as needed.

Trigger: up to four resource terms in sequence; final sequence term may use up to four ORed resource terms.

Restart: up to four ORed terms to reinitiate sequence search.

Store qualifiers: up to four ORed resource terms; may be separately defined for each term in the trigger sequence.

Occurrence: to 59 999; applies to final sequence term only.

Compare: width of analyzer by 16 words; trace until "equal to" or "not equal to" with each compare word matched to all 1024 words in memory; compare words may contain "don't care" terms.

Timing Analysis Mode

Clock

Range: 10 ns to 500 ms in 1, 2, 5 sequence.

Accuracy: $\pm 0.01\%$.

Glitch: min detectable glitch, 5 ns width at threshold; with glitch detection on, number of timing channels is halved.

Data Indexing

Asynchronous pattern: 20 ns to 1 ms in 1, 2, 5 sequence with accuracy $\pm 20\%$ or 15 ns, whichever is greater; glitch or edge ANDed with asynchronous pattern.

Maximum time delay: approx 2^{18} times the sample period, to 9999 s max.

Cursors: time between dual cursors (x and o) displayed to accuracy of one sample period.

Expansion: X1 to X40 in 1, 2, 4 sequence; standard display shows entire 1k memory at X1.

Interactive State/Timing Analysis Mode

Arming: the full data indexing capabilities of either the state or timing analysis mode can be used to arm the other analysis mode.

Software Performance Analysis and Overview Modes

XY Chart: all 1024 events/samples for any label group can be displayed as a chart of order of occurrence by magnitude; max and min vertical limits are user-specified.

Time interval histogram: measures time between start and stop events defined for up to eight time ranges.

Time range: min size, 1 μ s.

Display: histogram; min, max, average, and last time reading; total elapsed time; number of samples.

Resolution: for four-bit label group, 250 ns or 0.1% of reading, whichever is greater.

State histogram: sampled occurrence count of events in a label group for up to eight total user-defined ranges or values.

Max count: $2^{63} - 1$.

Resolution: $\pm 0.01\%$.

Probe inputs

RC: 100 k Ω $\pm 2\%$ shunted by approx 5 pF at probe body.

Min swing: 600 mV peak to peak.

Min input overdrive: 250 mV or 30% of input amplitude, whichever is greater.

Max voltage: ± 40 V, peak.

Threshold range: -9.9 to $+9.9$ V in 0.1 V increments.

Accuracy: $2.5\% \pm 120$ mV.

Dynamic range: ± 10 V around threshold.

General

Labels

Input channel: up to eight labels for state channels and up to 16 labels for timing channels; each label up to five characters. Bits may be used for more than one label, and need not be contiguous.

User field: user-defined labels for specified patterns for label groups of four or fewer bits.

Relocatable field: up to 16 starting locations within a label group.

Rear-Panel Outputs

HP-IB: connector and 8-position switch with 5 positions to determine address and 2 positions to set "talk-only" for hardcopy or system controller modes.

HP-IL: rear-panel port.

BNC: TTL output, high ≥ 2 V into 50 Ω , low ≤ 0.4 V into 50 Ω ; one of seven possible signals entered in menu from keyboard.

Operating Environment

Temperature: 0° to 55° C ($+32^\circ$ to 130° F).

Humidity: up to 95% at 40° C.

Altitude: to 4600 m (15 000 ft).

Vibration: vibrated in three planes for 15 min. each with 0.3 mm excursions, 5 to 55 Hz.

Power: 115/230 Vac, -22% to $+10\%$; 275 VA max; 48 to 66 Hz.

Size: 189 H x 426 W x 430 mm D (7.5" x 16.8" x 17.6").

Weight: 1630A 12.6 kg (28 lb) net, 17 kg (38 lb) shipping; 1630D 13.2 kg (29 lb) net, 17.7 kg (39 lb) shipping.

Accessories supplied: three 10271A state probes; one 10272A state and timing probe for 1630A, two 10272A state and timing probes for 1630D; one 82167A HP-IL cable; one 2.3 m (7.5 ft) power cord; one Operating Manual.

Ordering Information

1630A Logic Analyzer (35 channel)

1630D Logic Analyzer (43 channel)

Opt 001: add 82161A Digital Cassette Drive with U.S. charger

Opt 002: add 82161A Digital Cassette Drive with United Kingdom charger

Opt 003: add 82161A Digital Cassette Drive with Central European charger

Opt 004: add 82161A Digital Cassette Drive with Australian charger

Opt 005: add 82161A Digital Cassette Drive with Republic of South Africa charger

Opt 006: add 82161A Digital Cassette Drive without charger (for Japan)



64650A General Purpose Preprocessor

Preprocessors and Interfaces

Preprocessors and interface modules tailor Model 64620S Logic State/Software Analyzer and Model 1630A/D Logic Analyzer for use with specific microprocessor systems. Preprocessors provide quick, convenient connections between target microprocessor systems and logic analyzers. Inverse assemblers translate collected state events into the microprocessor mnemonics for easy reading and analysis. The interface software automatically sets formats for the logic analyzer to match inputs from the processor under test.

Micro-processor	64620S SOFTWARE ANALYZER		1630A/D LOGIC ANALYZER	
	64650A Interface Model No.	Clock Speed	10269A Interface Option No.	Clock Speed
8086/8088	64653A	10 MHz	053	10 MHz
8085	64655A	5 MHz	055	5 MHz
68000	64670A	8 MHz	070	12 MHz
6800/6802	64672A	2 MHz	072	2 MHz
Z8001	64680A	6 MHz	080	8 MHz
Z8002	64681A	6 MHz	081	8 MHz
Z80	64683A	6 MHz	083	8 MHz
General Purpose	64651B	10 MHz	100	25 MHz

Model 64650A General Purpose Preprocessor for a 60-channel 64620S Software Analyzer replaces a set of three 64635A Data Probes and one 64636A Clock Probe. Model 10269A Probe Interface, the preprocessor for the 1630A/D Logic Analyzer, has sockets for up to five probes. Interface circuits are contained on the interface modules, and the module boards are installed in the preprocessor units. Both microprocessor-specific and user-definable, wire-wrapping modules are available.

A dual-in-line probe from the interface module plugs directly into the target system, and the target processor plugs in the top of the same probe.

Preprocessors and interface modules reduce logic analysis set-up time by eliminating the need to manually connect each logic probe line separately. State listings in the microprocessor mnemonics correlate directly to the program listings, omitting the step of interpreting the processor code. Automatic formatting is another time-saving convenience.

General purpose, wire-wrapping interface modules include the hardware, chip sockets and interface board to create unique interfaces for microprocessors and minicomputer buses. For the 64620S Software Analyzer, a matching inverse assembler may be written using the Inverse Assembly Language software, Model 64856A.

Minicomputer Interfaces

Three interfaces access bus signals on minicomputers: Model 10275A PDP-11 Unibus^{®1} Interface, Model 10276A LSI-11 Q-Bus^{®1} Interface, and Model 52126A Intel MULTIBUS^{®2} Interface. Active circuits on the interface assure that bus-loading specifications are not exceeded and generate a clock signal for a logic analyzer. Minicomputer interface boards plug directly into the minicomputer.

Switches on each interface board are used to qualify information routed to the preprocessor by selected activity type. Any combination of monitored activities may be selected for a measurement.

Computer Activity	10275A	10276A	52126A
Reads	X	X	X
Writes	X	X	X
Interrupt vectors	X	X	
DMA transfers	X	X	
Refresh activity		X	
I/O transfers			X

Minicomputer bus activity may be monitored directly from the minicomputer interface boards using individual logic analyzer probe leads. In general, it is more convenient to take advantage of GP interfaces, Model 64650A with the 64651B interface module installed or Model 10269A Option 100. Bus signal routing can be defined on the preprocessor general-purpose interface board.

¹Registered, Digital Equipment Corporation

²Registered, Intel Corporation

LOGIC ANALYZERS & DEVELOPMENT SYSTEMS

Preprocessors and Interfaces

Models 64650A and 10269A (cont.)

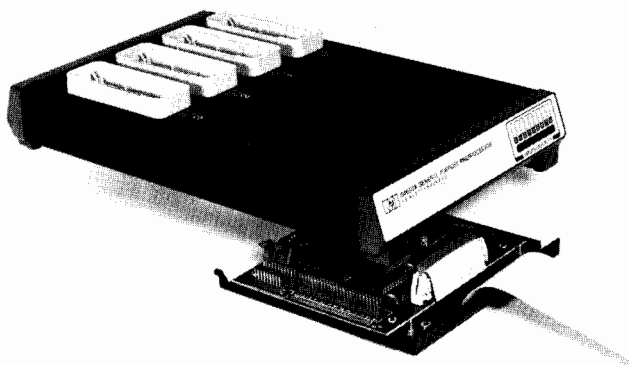

64650A

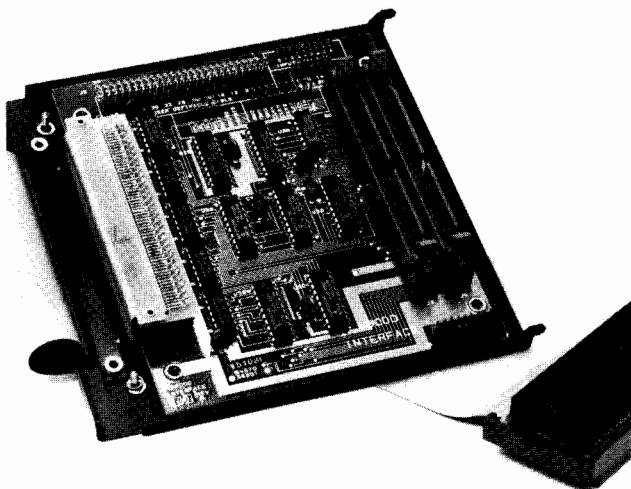

Interface Board

64650A Specifications

Channel width: 60 channels.

Qualified clock rate: 10 MHz.

Input

RC: 100 k Ω shunted by < 20 pF at interface module connector.

Maximum: ± 40 V.

Dynamic range: threshold ± 10 Vdc in 0.1 V increments.

Minimum single swing: 600 mV.

Minimum clock pulse width: > 20 ns.

Setup and Hold Times

Clock qualifier setup time: 20 ns min.

Clock qualifier hold time: zero.

Data setup time: 37 ns min; clocked by preprocessor, 23 ns min.

Data hold time: zero; when clocked by the preprocessor, 7 ns min.

Power

Consumption: 0.8 A max at +5 V; 2.5 V max at -5.2 V.

Available for interface module: 1.0 A max at +5 V.

Note: all power supplied by the software analyzer subsystem.

Environmental

Temperature: operating, 0° to 55° C (+32° to +131° F); non-operating, -40° to +75° C (-40° to +167° F).

Altitude: operating, 4600 m (15 000 ft); nonoperating, 15300 m (50 000 ft).

Humidity: operating, to 90% noncondensing.

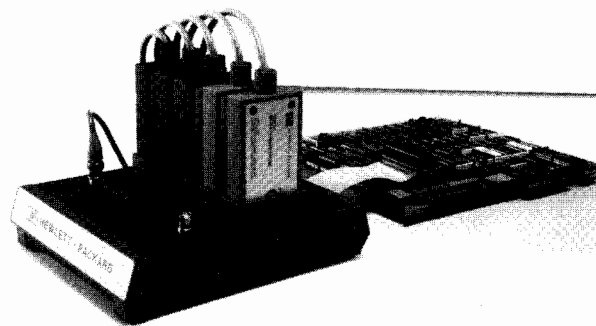

10269A

10269A Specifications

Channel width: 43 data channels and 3 clock channels.

Qualified clock rate: 25 MHz max.

Input

Impedance: 100 k Ω < 20 pF at interface module connector.

Maximum: ± 40 Vdc.

Dynamic range: threshold ± 10 V in 0.1 V increments.

Minimum clock pulse width: 10 ns.

Setup and Hold Times

Setup time: 20 ns min.

Hold time: zero.

Power

Power available for interface module: 1.0 A max at +5 Vdc, supplied by 1630A/D Logic Analyzer.

Environmental

Temperature: operating, 0° to +55° C (+32° to +131° F); non-operating, -40° to +75° C (-40° to +167° F).

Humidity: to 90% at +40° C, noncondensing.

Altitude: operating, 4600 m (15 000 ft); nonoperating, 15 300 m (50 000 ft).

Ordering Information

10269A Probe Interface

Opt 053 8086/8088 Interface Module

Opt 055 8085 Interface Module

Opt 070 68000 Interface Module

Opt 072 6800/6802 Interface Module

Opt 080 Z8001 Interface Module

Opt 081 Z8002 Interface Module

Opt 083 Z80 Interface Module

Opt 100 Wire-wrapping Interface Module

Opt 101 Microprocessor Interface Kit for Opt 100

Opt 102 40-pin Cable and Connector for Opt 100

Opt 103 48-pin Cable and Connector for Opt 100

Opt 104 64-pin Cable and Connector for Opt 100

10275A PDP-11 Unibus Interface board

10276A LSI-11 Q-Bus Interface board

52126A Intel MULTIBUS Interface board

64650A General Purpose Preprocessor

64651B Wire-wrapping Interface Module

Opt 001 Microprocessor Interface Kit for 64651B

Opt 010 40-pin Cable and Connector for 64651B

Opt 011 48-pin Cable and Connector for 64651B

Opt 012 64-pin Cable and Connector for 64651B

64653A 8086/8088 Interface Module

64655A 8085 Interface Module

64670A 68000 Interface Module

64672A 6800/6802 Interface Module

64680A Z8001 Interface Module

64681A Z8002 Interface Module

64683A Z80 Interface Module

64856F User-defined Inverse Assembler on flexible disc

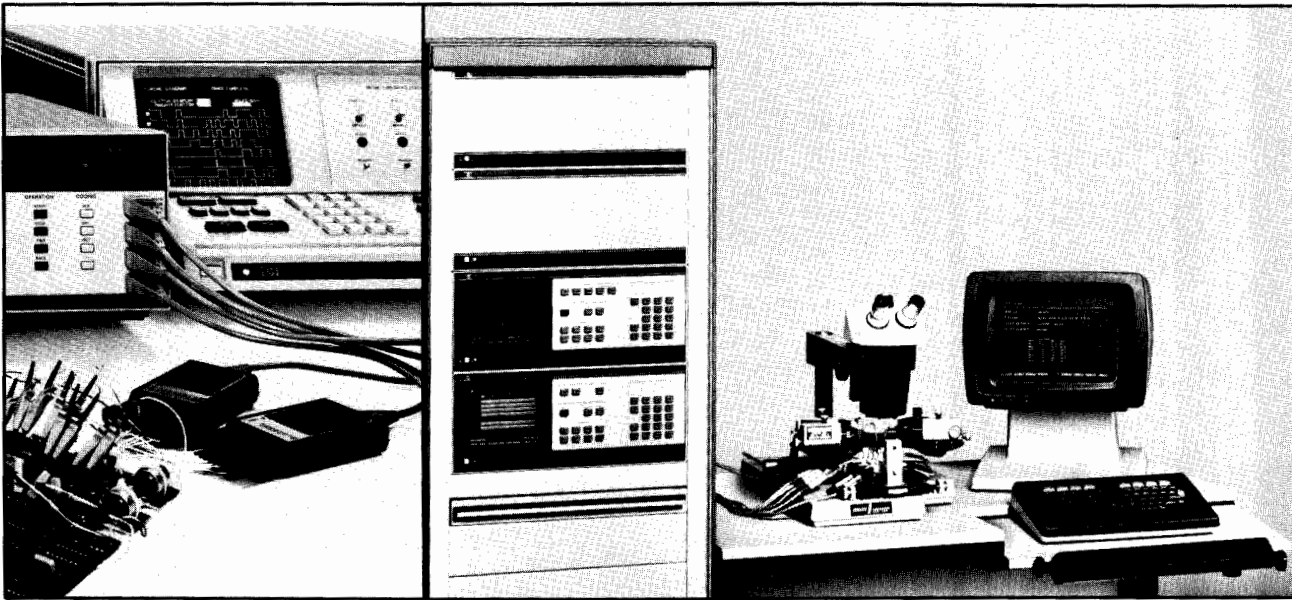

Engineering Efficiency

HP's data generators and data analyzers are engineering tools which enhance, and, at the same time, simplify the evaluation of digital hardware. Enhanced because at-speed testing assures performance. Simpler because bench-top transportability plus front panel and HP-IB access mean quick set-up and fast response to engineering problems. Variable parameters and programmable data save time and equipment because they make dedicated solutions and unwieldy arrays of many different instruments unnecessary.

Independence

Data generators and analyzers functionally test digital devices under real conditions independent of supporting hardware or large test systems. Models with variable timing and levels permit full characterization, are convenient and need no additional equipment.

Project times are consequently shortened because parallel development is feasible, and problems are detected earlier in design and

production engineering phases. Equipment accessibility makes QA and materials engineering less dependent on other areas, and at-speed module testing enhances system assurance.

Long term investment is ensured through flexibility. Pulse performance and choice of levels ensure suitability for all common logic families, and quality connectors mean swift adaptation to an IC, IC prototype, breadboard, board, module, etc., with specified performance at the device.

Separate packaging saves equipment and promotes mobility because the generators and analyzers can be paired to match input and output needs. Also, separate use is feasible for either multi-channel output devices which are essentially stimulus-independent, or multi-channel input devices with "simple" outputs which can be effectively monitored with an oscilloscope or voltmeter.

Comprehensive

Data generators: include the Serial generators 8018A, for PCM and similar applications, and the sub-nanosecond 8080A. Multi-

channel requirements are met by the 8170A, with additional capability for hand-shake devices, and the 8016A with variable timing. High pin-count requirements are solved by the 8180A which has extensive timing capability and can be configured to the number of channels needed.

Analyzer: at-speed functional and ac-parametric testing is covered by the 8182A which is extendible for high pin counts on all types of digital hardware.

Direct Measurement of ac Parameters

Performance credibility demands full specification of all timing and level criteria. With variable analog timing and levels, the 8180A Data Generator and 8182A Analyzer form a compact, comfortable solution for all engineering investigations. Parameters such as setup, hold and propagation times, sensitivity and dynamic fanout capability are measured directly. High resolution allows the exact pulse shape to be delivered, and precise sampling.

Selection Chart

APPLICATION	Model Page	GENERATORS					ANALYZER
		8080 A 320	8018 A 175	8016 A 173	8170 A 174	8180 A/8181 A 170	8182 A 170
Functional and AC Parametric Test Functional Test only		ECL Digital Hardware	ECL, TTL, CMOS Serial Digital Hardware	ECL, TTL Digital Hardware	TTL, CMOS Digital Hardware, I/O.	ECL, TTL, CMOS and Mixed Logic IC's, Prototypes, Breadboards, Boards and Modules.	
Data Rate (Bits/s)		300 M	50 M	50 M	2 M	50 M	50 M
Channels		1-4	2, serializable	9, serializable	16	8-64	8-32
Bits/Channel		64	1k + prbs	32	1 - 4k	1k	1k
Variable Parameters		Level, Delay, Width	Level	Delay Width	—	Levels, Delays, Widths	Thresholds, Sampling Delay, Real-time Window

DATA GENERATORS & DATA ANALYZERS

Data Generator/Analyzer System
Models 8180A, 8181A, 8182A

- Digital ac parametric and functional characterization
- 50 MHz, 1 kbit/channel
- Direct measurements, 100 ps/10 mV resolution
- Variable sampling point delay in synchronous operation
- Real-time data comparison
- Convenient softkey operating concept with live keyboard

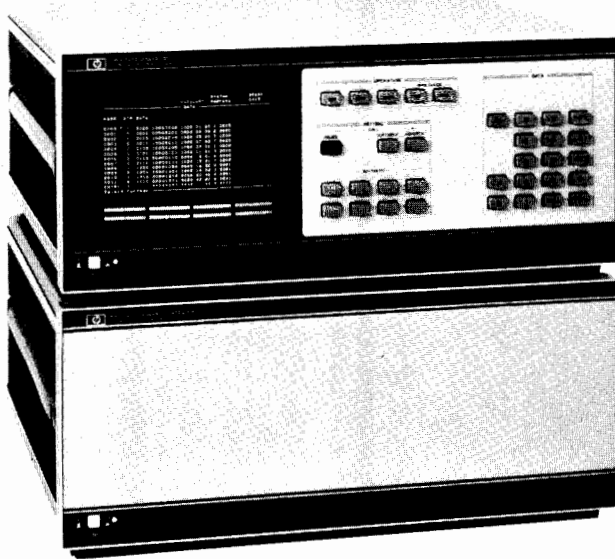

Upper: 8180A Data Generator
Lower: 8181A Data Generator Extender
Up to 64* channels with 8180A and two 8181A's.

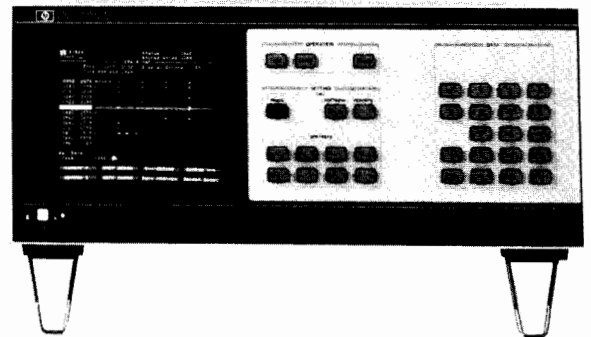

8182A Data Analyzer (up to 32* channels)

*Number of channels can be doubled by parallel operation.

An Affordable Engineering Tool for At-Speed Characterization of Digital Hardware.

This compact, benchtop system is designed for manual and automatic engineering investigations on all types of digital hardware. It also upgrades ATS to at-speed testing. Features such as the same high resolution for generator and analyzer, and matched control signals, guarantee the viability of these measurements. Modularity promotes cost-effectivity because the number of channels can be increased without loss of speed or memory.

The same guided operating concept speeds familiarization, and common HP-IB syntax and free format accelerate programming. Live keyboards give rapid parameter access without changing software. Data entry is simplified by the selectable patterns and extensive edit features. Mixed logic needs are solved because up to 6 different levels can be assigned to any number of individual channels.

Data Generator Timing capabilities include individual delay and width on two clock channels for dual-phase applications, and on RZ data channels for setup and hold time measurements. 8181A Extender group delay allows separate timing of e.g. simulated address signals.

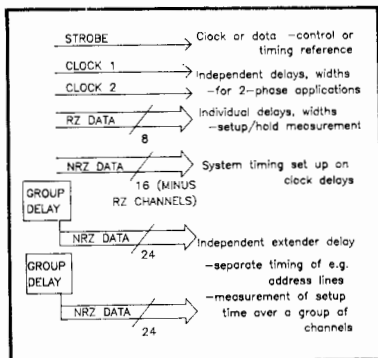

High-speed pulses and clean shape provide performance for all common logic. Variable, high resolution, levels allow worst-case conditions to be measured. The segmentable memory allows initiating and loop data (with exit on external command) to be set up.

Data Analyzer In addition to at-speed analysis, comparison and glitch detection, the 8182A also measures multichannel output timing like propagation delays because the sampling point is variable. For investigations in e.g. the setup/hold interval, a real-time compare mode examines data stability throughout a programmable window: any deviation from the expected state is displayed and error signals permit operations such as 'stop on error' for trapping sporadic faults.

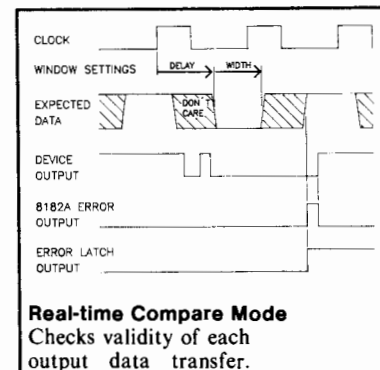

Real-time Compare Mode
Checks validity of each output data transfer.

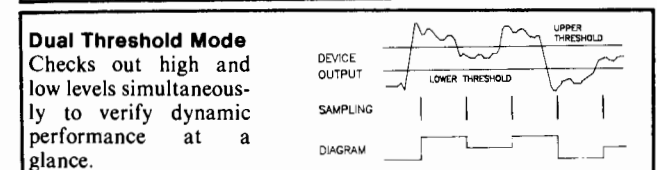

Dual Threshold Mode
Checks out high and low levels simultaneously to verify dynamic performance at a glance.

Specifications

Specifications apply for operating temperatures from 0°C to 50°C.

8180A/8181A Data Generator/Extender

Memory and Channels

Memory depth: 1024 bit/channel.

Number of channels: up to 64 using 8180A with two 8181A Extenders. Up to 128 channels with 2 sets of equipment in parallel operation.

8180A Channels

RZ (return-to-zero) channels: independent variable delay and width in each of up to 8 channels.

NRZ (non-return-zero) channels: Up to 16 channels minus the number of RZ channels. Fixed timing.

Strobe channel: NRZ data or clock. Fixed timing.

Clock channels: independent delay and width in each of 2 channels. Clock 1 can be selected to run continuously in Break state (see 'Cycle modes').

8181A Channels

NRZ: up to 24 channels. Fixed timing within an Extender, group delay with respect to 8180A.

Memory Segmentation

Active Segment: user-defined by first and last addresses (FAD, LAD) in the range 0 to 1023. Store/recall allows 10 different FAD/LAD pairs to be stored.

Initializing segment: segment 0 to FAD initializes DUT.

Memory Loading

Codes: bin, oct, hex, dec (address codes: oct, hex, dec).

Entry: Keyboard or HP-IB.

Displayed channel order: user-defined.

Line edit: insert, delete, macro.

Channel edit: clear, set, copy, prbs, counts, entry mask.

Cycle Modes

Single, Auto, Initialization + Auto, Gated, Initialization + Gated. (Initialization data is output at the beginning of the first cycle only).

Break state: implemented by manual or external BREAK command or by strobe channel bit. Data is held at current address. Manual or external RUN command cause same cycle to continue.

Stop state: implemented by manual or external STOP command. Data is held at current address and the cycle is terminated. Manual or external RUN command trigger a new cycle.

Timing

Clock period: 20 ns to 950 ms (1.05 Hz to 50 MHz). Ext clock 0 to 50 MHz.

Delay (relative to strobe channel): 0.0 ns to 950 ms, max 90% period - 18 ns.

Width: 10.0 ns to 950 ms, max 90% period - 8 ns.

Skew: ≤ 2 ns for NRZ channels and RZ channels programmed for zero delay.

Resolution: 3 digits (best case 100 ps).

Accuracy: $\pm 5\%$ of programmed value ± 1 ns.

Jitter: $\leq 0.2\% + 100$ ps (+additional 50 ps for delay and width).

Outputs

Output impedance: 50 Ohm.

Data and clock: 4 different high level/low level pairs can be defined and assigned to any number of individual outputs. Each channel has independent normal/complement switching. Common 'off'.

Read-out: can be selected for 50-Ohm or high-impedance load (common selection for all channels).

	50-Ohm load	High-impedance load
High level:	-1.50 to +5.50 V	-1.00 to +17.0V
Low level:	-2.00 to +5.00 V	-2.00 to +16.0 V
Resolution:	3 digits (10 mV)	3 digits (best case 20 mV)
Amplitude:	0.5 to 5.5 V	1.0 to 17 V

Transitions

10% to 90%: (3 + 0.2 |amp|) ns (3 + 0.5 |amp|) ns

20% to 80% at ECL levels: 1.5 ns.

Strobe: ECL/TTL selectable.

Tri-state

For bi-directional applications, the 15413A and 15414A tri-state accessories are available. These are described on the next page.

8182A Data Analyzer

Memory and Channels

Memory depth: 1024 bit/channel.

Number of channels: up to 32. Can be doubled by parallel operation of two 8182A's.

Expected data memory: 1024 bit/channel, segmentable.

Codes: bin, oct, hex (address code: dec).

Entry: Keyboard, HP-IB or read-in from DUT.

Displayed channel order: user-defined.

Line edit: word mask (don't care), insert, delete.

Channel edit: clear, set, copy, mask (don't care), exchange.

Modes

Analysis/store-and-compare: synchronous sampling with variable analog sampling point delay or asynchronous sampling. Comparison with expected data, if required.

Displays: state list, diagram or error map.

Glitch detection: down to 5 ns. Memory depth is halved when glitch detection is selected.

Trigger condition: can be selected to start or stop analysis.

Real-time compare: comparison of actual with expected data throughout a time window. Window has variable analog delay and width. Real-time and latched error output signals are provided.

Display: error map.

Trigger condition: starts comparison.

Timing

External clock: 0 to 50 MHz.

Delay (relative to external clock): 0.0 ns to 1 s, max 95% period - 1 ns.

Compare window width: 10.0 ns to 1 s, max 95% period - 9 ns.

Channel skew: ≤ 2 ns.

Resolution: 3 digits (best case 100 ps).

Accuracy: $\pm 5\%$ of programmed value ± 1 ns.

Internal clock: 1 Hz to 50 MHz. (1-2-5 steps).

Inputs

Data: 6 different thresholds or dual threshold pairs can be defined and assigned to any number of individual inputs. Each measuring channel selected for dual threshold operation occupies two normal channels.

Clock: programmable threshold and selectable slope (positive, negative, both).

Input impedance: 1 M Ω , < 7 pF.

Control signals: (100 k Ω /50 Ω selectable input impedance)

Trigger arm and ext stop signals: independent programmable thresholds and selectable slope (positive, negative, don't care).

Trigger qualifier and clock qualifier signals: independent programmable thresholds and selectable levels (high, low, don't care).

Threshold range: -10.0 to +10.0 V.

Dynamic range: threshold ± 10 V.

Resolution: 3 digits (best case 10 mV).

Trigger

Trigger arm, word and qualifier, digital filter (1 to 16), clock and qualifier, delay (0 to 65535).

Ordering Information

8180A Data Generator* (includes 8 NRZ channels)

Opt 001 4 additional NRZ channels

Opt 002 4 additional RZ channels

8181A Data Generator Extender (includes 8 NRZ channels)

Opt 001 4 additional NRZ channels

8182A Data Analyzer* (includes 8 channels)

Opt 001 8 additional channels

Accessories and Information.

Refer to the next page for accessories. For more detailed information, the following publications are available: Product Brochure (5952-9548), Application Note 319 (5952-9549), 8180A/81A Technical Data (5952-9550), 8182A Technical Data (5952-9551), 15413A/14A Technical Data (5952-9556).

*HP-IB cables not included, see page 37



DATA GENERATORS & DATA ANALYZERS

Tri-State and Accessories for 8180/81/82A

Models 15406A to 15416A and 15421A to 15423A

TRI-STATE EQUIPMENT, MODELS 15413A/14A

- 4-24 channels
- Levels programmable via 8180/81A
- Selectable 'inhibit' conditions
- Fast tri-state switching

15414A TRI-STATE UNIT

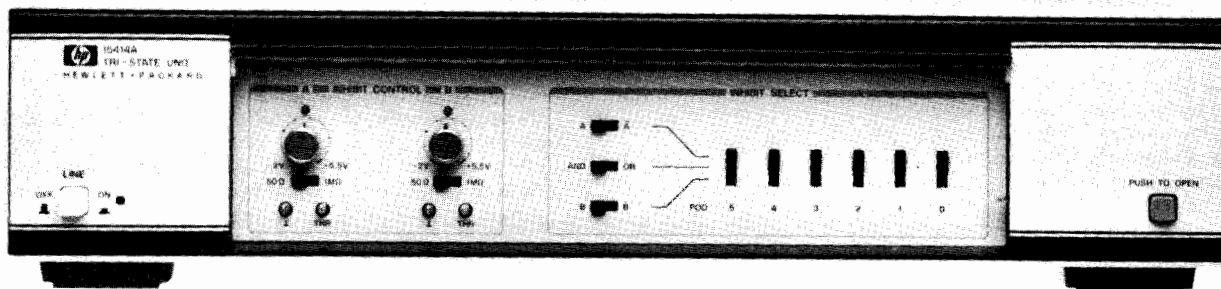

15413A TRI-STATE POD

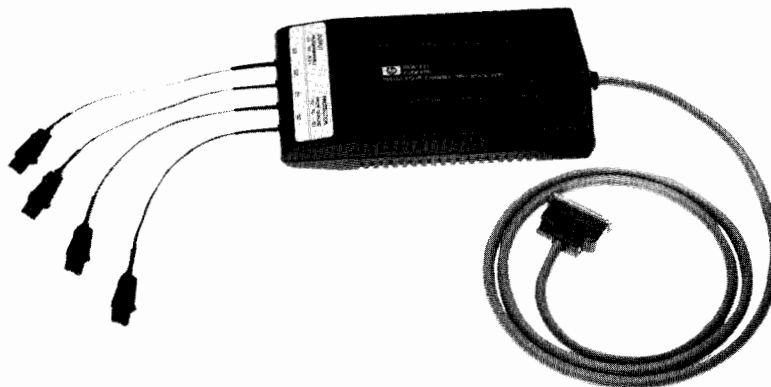

The 15414A Tri-State unit and the 15413A Tri-State pods were developed in order to electronically disconnect the data generator/extender from a data bus. This is necessary in applications where other devices control the same bus lines. The data outputs are switched to high impedance by one or two inhibit signals applied to the 15414A. Selectable inhibit conditions allow individual control of 1 to 6 pods, each of which carry 4 data lines. The maximum data rate remains 50 MHz.

15413A Specifications

Number of channels: 4

On-State Characteristics

Input level range: -2V to 5.5V

Output level accuracy (into open): add +/-50 mV to 8180A accuracy

On-resistance: < 30 Ohm

Output transition time (into open) for a 5 V 8180/8181A input signal: < 7ns

With 100 pF load: < 12ns

Skew across all pods: add 2ns to 8180A/81A specification

Off-State (Tri-State) Characteristics

Off-resistance: > 1 MOhm

Residual capacitance: < 35pF (typ. 30pF)

Leakage current: < 1μA

t-on, t-off propagation delay with respect to inhibit input: < 40ns

15414A Specifications

Number of channels: 24 (up to 6 x 15413A can be connected)

Inhibit threshold range: -2V to + 5.5V, adjustable

Inhibit threshold accuracy: voltage at monitor point +/- 50mV

Inhibit threshold overdrive: > 50 mV

Min. inhibit amplitude: 100mVpp

Inhibit impedance: switch selectable 50 Ohm/1 MOhm, 20pF

Ordering Information

15414A Tri-State Unit

15413A Tri-State Pod

Each pod includes a set of grabbers (15408A)

8180A/8181A/8182A/15413A ACCESSORIES

15406A 8182A clock probe (supplied)

15407A 8182A cable set with probes for 4 data channels (supplied)

15408A 5 plug-on grabbers with ground leads (supplied with 8182A and 15413A)

15409A 5 plug-on BNC adaptors (available)

15410A 5 plug-on SMB adaptors (available)

15411A 5 plug-on coax open-end adaptors (available)

15412A 20 solder-in receptacles (supplied)

15415A 5 plug-on miniprobes (for HP 10024A IC test clip) (available)

15416A cable for parallel operation of 2 each 8182A (available)

15421A cable for parallel operation of 2 each 8180A (available)

15422A 8180A cable set for clock 1, clock 2 and strobe (supplied)

15423A 8180/81A cable set for 4 data channels (supplied)

DATA GENERATORS & DATA ANALYZERS

9-Bit Parallel, 32-Bit Serial, 50 MHz Word Generator

Model 8016A

173



- 2 complementary outputs per channel, RZ/NRZ formats
- Variable RZ width, 4 delay channels
- Channel serializer
- TTL/ECL output levels selectable

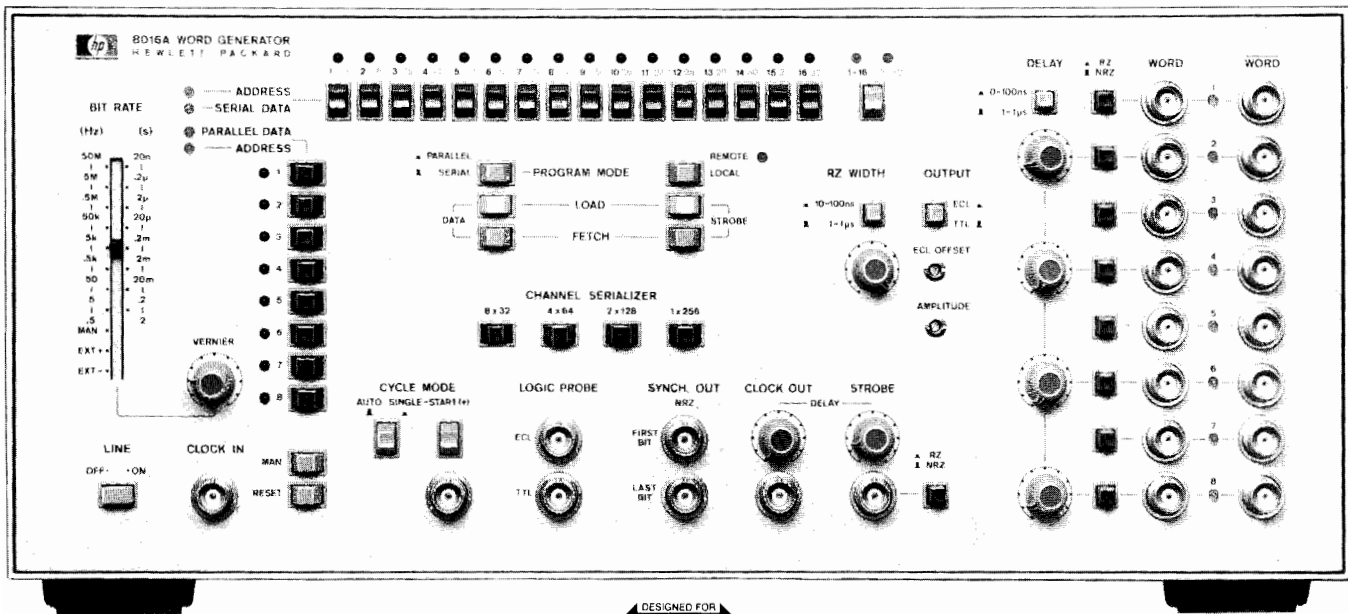

Option 001

The 8016A is a 9-channel data generator capable of serialization up to 256 bits. For the digital designer the 8016A is a natural companion to multichannel data display devices such as logic analyzers. As a bench or systems component, the 8016A provides programmable digital patterns plus adjustable timing parameters necessary for testing ICs and circuit boards.

Functional Test

Bit pattern programmability combined with fast cycle time (50 MHz clock) make the 8016A especially effective in simulating worst case conditions, e.g. high speed IC testing. The 8016A saves time in component evaluation environments because test setups can be rapidly built and reconfigured to meet the demands of testing small quantities of a wide variety of IC types.

Parametric Test

Complete testing of digital circuits and systems requires not only digital patterns for functional test but control of the analog parameters of the pulses as well. Adjustable pulse widths, levels, and inter-channel delays contribute to measurements such as setup and hold times, clock pulse width sensitivities, and system sensitivity to propagation delay variations. To meet these testing requirements, the 8016A includes 6 independent delay circuits. Output levels of the 8016A's 50 Ω output amplifiers are selectable for ECL or TTL test specifications and can be adjusted. In addition, a choice of RZ or NRZ formats with variable RZ pulse width is provided.

Specifications

Data capacity: 8 data channels plus 1 strobe channel, each 32 bits. 8 data channels can be serialized as four 64-bit channels, two 128-bit channels or a single 256-bit channel.

Data loading: address channel, enter 32 serial bits in that channel. Alternatively, address parallel word, enter (max 8) bits in that word. Addressing/entry by pushbuttons/LEDs or via HP-IB (option 001).

Data Outputs: (50 Ω source into 50 Ω load).

Format: independent RZ/NRZ selection in each channel.

RZ width: single continuous adjustment in ranges 10-100 ns, 0.1-1 μ s.

Width jitter: $\leq 0.2\% + 50$ ps

Complement: simultaneous normal and complement outputs for each channel.

Delay: channels 2, 4, 6, 8 can be delayed independently within the ranges 0-100 ns, 0.1-1 μ s with respect to odd channels.

Jitter: $\leq 0.1\% + 5$ ps

Skew (undelayed): ± 1 ns

Levels: ECL/TTL selectable

Transition times: ≤ 3.0 ns (ECL ≤ 2.5 ns)

Bit Rate

Internal: 0.5 Hz to 50 MHz.

External: dc to 50 MHz, or manual.

Data Cycling

Auto: Sequence recycles continuously.

Single cycle: Sequence is triggered/gated by external pulse/level.

General

Operating temperature: 0°C to +50°C.

Power: 100/120/220/240 Vrms; +5%, -10%; 48 Hz to 66 Hz, 200 VA (maximum)

Weight: net, 14.5 kg (32 lb). Shipping 16 kg (35.3 lb).

Size: 177 H x 426 W x 422 mm D (7" x 16.8" x 16.6").

Ordering Information

8016A Word Generator

Opt 001: HP-IB for data loading*

Opt 907: Front Handle Kit (Part No. 5061-0090)

Opt 908: Rack Flange (Part No. 5061-0078)

Opt 909: Opt 907, 908 combined (Part No. 5061-0084)

Opt 910: Additional Operating and Service Manual

*HP-IB cables: Refer to page 37.

DATA GENERATORS & DATA ANALYZERS

Logic Pattern Generator
Model 8170A

- 8k memory (32k option)
- 8 bit / 16 bit parallel output
- 2 wire / 3 wire handshake capability
- Internal and external addressing

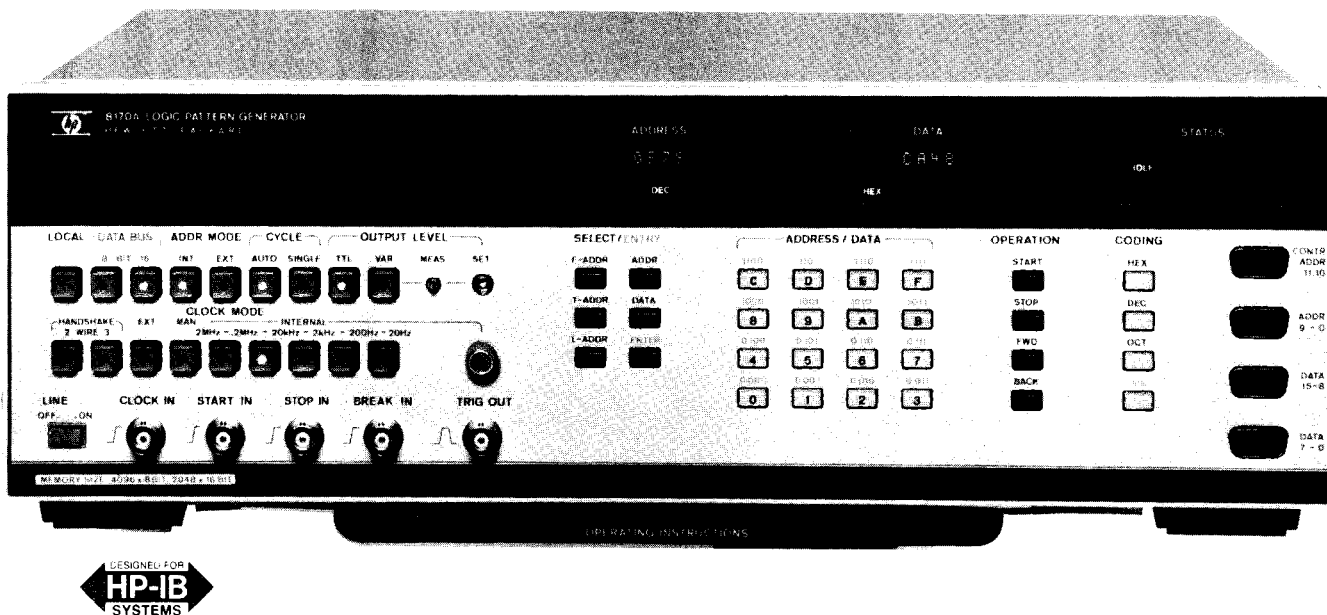

Parts, memories and peripherals can be verified at all stages in design and production because the 8170A allows testing in isolation from the system. Busses or devices can be stimulated synchronously or asynchronously with data from the 8170A's memory. Address outputs (Option 002) allow writing into a RAM for subsequent comparison on e.g. a logic analyzer. In external address mode, software can be setup, verified and modified in the 8170A before committing ROM's.

The 8170A memory can be programmed manually, via HP-IB or by selecting one of the fixed patterns. User codes can be used directly because conversion is handled automatically.

Specifications

Memory: 8 kbit (32 kbit Opt 001). 8- or 16-bit width, selectable. Freely programmable or selectable patterns (Set/reset/prbs/count up/down).

Address Modes

Internal: ascending sequence between user-defined addresses.

External: 10-line address plus 4 enable lines. Max rate 2 Mbit/s.

Clocking

Internal: 20 Hz to 2 MHz in 5 ranges.

External: dc to 2 MHz.

Manual: forward/backward data stepping.

Handshake: 2-wire/3-wire (IEEE 488) selectable.

Cycle Modes (applies to Int Address mode)

Auto cycle: data cycled continuously.

Single cycle: data is cycled once per Start In command.

Outputs

Data: 8 or 16 lines, selectable. Pos/neg true selectable.

Control: data Valid. Pos/neg true selectable.

Status: 2 lines indicate whether data is clocked, static or off.

Levels: TTL or adjustable +3 V to +15 V.

Address (via Opt 002 pod): 10 lines, +2.4 V true, +0.5 V false.

Inputs

Address: 10 lines (12 lines in Opt 001).

Control: ready for Data and data accepted lines.

Enable: 4 lines.

Levels: high +2.0 V, low +8.0 V.

Remote control: HP-IB, RS-232C (CCITT V.24).

General

Power: 100/120/220/240 V rms; +5%, -10%; 48-66 Hz, 110 VA max.

Operating temperature: 0°C to 55°C.

Weight: net 11 kg (24.3 lbs). Shipping 15 kg (33.2 lbs).

Dimensions: 133 H x 426 W x 422 mm D (5.2" x 16.8" x 16.6").

Ordering Information

8170A Logic Pattern Generator*

Opt 001: 32 kbit Memory

Opt 002: Address Driver Pod (Model 15452A)

Opt 907: Front Handle Kit (part number 5061-0089)

Opt 908: Rack Mount Kit (part number 5061-0077)

Opt 909: Opt 907, 908 combined (p/n 5061-0083)

Opt 910: Extra Operating and Service Manual

15457A Pod Connector (Pods can be easily plugged

into DUT when this accessory is wired in)

15459A 1.5 m pod extension cable

Supplied Accessories

15453A Address input pod

15454A Control Pod

15455A Data Pod (D0-D7)

15456A Data Pod (D8-D15)

15458A Snap-on Assembly (one per pod)

10230-62101 Hook-on Clip

*HP-IB cables not furnished, see page 37.

DATA GENERATORS & DATA ANALYZERS

50 MHz Serial Data/PRBS Generator

Model 8018A

175



- 2048 bit, dual channel memory
- Variable word and pattern length

- TTL, ECL, CMOS compatible
- Programmable, prbs and mixed data

Option 001

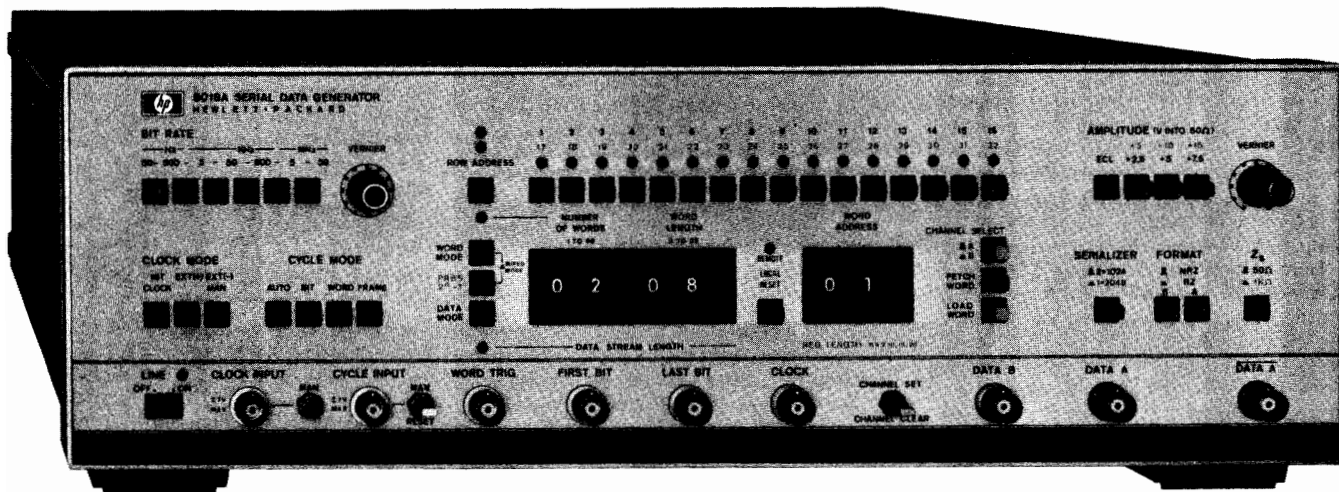

With 2048 programmable bits, and a choice of pseudo-random binary sequences (prbs) ranging to over 1 Mbits, the 8018A is a powerful stimulator for serial digital systems and devices requiring high bit rate and fast pulses. Even preamble-data-post-amble data link patterns are feasible by combining prbs and programmed data. Useful synch outputs simplify testing by locking scope or analyzer to unique points in the data stream.

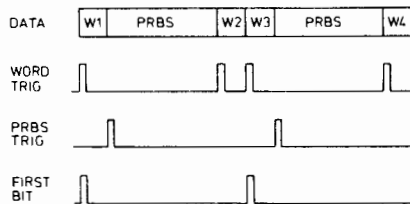

For data link patterns, mixed mode inserts a prbs after each odd word.

For dual-channel applications, the memory splits so that the outputs have independent 1 Kbits of data.

A high performance output amplifier adds to the 8018A's wide applicability. It delivers clean, 6 ns pulses with repetition rates from dc to 50 Mbits/s. Output amplitude is variable up to 15 volts into 50 Ω . This enables you to directly drive logic circuits ranging from TTL to CMOS. Output levels for emitter-coupled-logic (ECL) are also provided.

To handle patterns for repetitive tests more conveniently, data can be loaded via HP-IB (Option 001).

Specifications

Data Capacity and Modes

Programmable memory: 2 channels, each 1 kbit, serializable. Thumbwheel switches define data stream length or frame length (N words of Mbits), and set up synch signals accordingly.

Prbs: pseudo-random binary sequences of 511, 1023, 32767 and 1048575 bits. Synch pulse at beginning of sequence.

Mixed: prbs is inserted after every odd-numbered programmable word.

Data Outputs

Channel A: simultaneous normal and complement outputs. ECL levels or variable +15 V amplitude. Selectable 50 Ω /1 k Ω output impedance, RZ/NRZ format.

Data length: up to 1024 bit or (serialized with B data) 1025 to 2048 bit.

Transitions (50 Ω into 50 Ω): ≤ 6 ns (ECL ≤ 5 ns)

Preshoot, overshoot, ringing: $\leq 10\%$ (ECL $\leq 15\%$)

Channel B: normal output, 2.4 V (50 Ω into 50 Ω), up to 1024 bits, RZ/NRZ selectable.

Bit Rate

Internal: 50 Hz to 50 MHz (40 MHz in Mixed mode), jitter 0.2%

External: dc to 50 MHz (40 MHz in Mixed mode) or manual.

Data Cycling

Auto: sequence recycles continuously.

Bit: bits are triggered/gated by external pulses/level.

Word: words are triggered/gated by external pulses/level.

Frame: sequence is triggered/gated by external pulses/level.

Manual: switch triggers single bits/words/frame.

General

Power: 100/120/220/240 V rms; +5%, -10%; 48 to 440 Hz. 230 V A max.

Temperature range: 0°C to 50°C.

Weight: net 12 kg (26.5 lbs). Shipping 16 kg (35.3 lbs).

Size: 133 H x 426 W x 422 mm D (5.2" x 16.8" x 16.6").

Ordering Information

8018A Serial Data Generator

Opt 001: HP-IB for data loading*

Opt 907: Front Handle Kit (Part No. 5061-0089)

Opt 908: Rack Flange Kit (Part No. 5061-0077)

Opt 909: Opt. 907, 908 combined

(Part No. 5061-0083)

Opt 910: Extra Operating and Service Manual

* HP-IB cables: refer to page 37.



Introduction

Waveform recorders provide extensive measurement capability, combining important features of storage oscilloscopes and digital voltmeters. They sample analog input waveforms, convert the samples to digital form, and store these digital representations of waveforms in memory. Waveform recorders are ideal for recording transients. Because they are built around high-speed analog-to-digital converters (ADC's), they capture waveform information in a single-shot manner. They also make a contribution in recording repetitive waveforms, because they provide accurate voltage information. For repetitive signal recording, equivalent time sampling systems based on low-speed ADC's (e.g. 1980/19860 Oscilloscope Measurement System) are also available, and often have much higher input bandwidths than do waveform recorders.

A major advantage of waveform recorders is their ability to record information before a trigger occurs. When a waveform recorder is armed for triggering, digitized samples flow into memory. At the time of the trigger, waveform information which is already in memory may be saved; thus, "pre-trigger" recording is possible. For example, the first transient shown was recorded on a storage scope. Notice that no pre-trigger information is available. When a waveform recorder set in pre-trigger mode captures the same transient, a display of the waveform shows information prior to the trigger point, and values such as rise times and voltages can be calculated using the stored digital information.

Digital storage of waveform data provides several other advantages. Waveforms can be

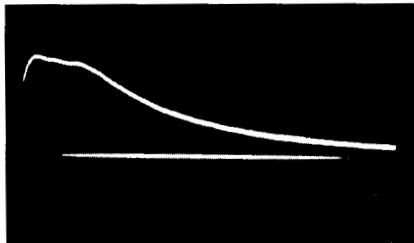

Transient recorded by storage scope contains no pre-trigger information.

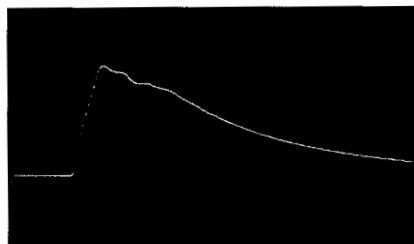

Transient captured by 5180A Waveform Recorder shows initial pre-trigger voltage change.

re-created on a CRT display, or a portion of a waveform may be expanded in the display to show detail. In addition, digitized waveforms can be saved permanently on tape or disk, or processed by digital computer.

Selecting A Waveform Recorder

In determining whether or not a waveform recorder will work in a given application or solve a particular problem, the first features to consider are the instrument's maximum sampling rate, and its voltage resolution in terms of number of bits. However, these hardware specifications don't tell the whole story: as a waveform recorder samples more rapidly changing signals, the accuracy of the digitized output values decreases. To determine whether a waveform recorder is adequate, then, some measure of its "dynamic performance" is needed.

Dynamic Performance

Hewlett-Packard has made an important contribution in this area, by developing tests for measuring how well the digital output codes from a waveform recorder represent an analog input waveform. These dynamic performance tests determine the degradation in a waveform recorder's performance as the sampling rate and the frequency of the input signal increase.

The dynamic performance tests: 1) identify digital codes which are missing or which occur too frequently; 2) measure harmonic distortion caused by nonlinearities in the ADC transfer function; 3) determine the number of bits of information which are reliable (effective bits). These tests (and others) are described in detail in Product Note 5180A-2 "Dynamic Performance Testing of Analog-to-Digital Converters."

Other features to consider in selecting a waveform recorder include:

Input Channels

Number of channels: when more than one waveform must be recorded at a time, multiple input channels are necessary. Simultaneous waveform recording may then be provided by two ADC's, or by a single ADC alternating sampling between the two input channels.

Voltage range selection: variable input voltage ranges make it possible to obtain maximum resolution on small or large amplitude signals. In addition, waveform recorders may provide selectable input voltage offsets, so the input voltage range can be centered around a signal with a DC offset.

Triggering

Precise trigger level selection: trigger level in a waveform recorder should be accurately and reliably selectable.

Reliable triggering: it is essential that triggering be dependable in waveform recorders, since these instruments are optimized for capturing transients which are often non-repeatable.

Memory

Sufficient memory size: the number of memory words required for a given input signal depends on both the duration of the signal and the required sampling rate.

Change sampling rate during recording: when a portion of signal has a large information content compared to the rest of the signal, the ability to change sampling rate during a recording makes it possible to conserve memory space. This is done by sampling at a high rate where the information content is greater, and switching to a lower rate where the input signal contains less information.

Segmentable into multiple records: waveform recorders with memory which can be divided into independent records make it possible to record and store more than one waveform.

Display Features/Benchmark or Manual Measurements

Cursors: cursors make it possible to select points of interest in a displayed waveform.

Voltage and time indicators: direct read-out of voltages and times in any location on a displayed waveform eliminates the need to estimate these values.

Zoom: expanding a portion of a stored waveform in the display makes it possible to see detail.

Number of display traces: two or more display traces allow waveform comparison.

Operating Convenience Features

Preset/autoset: a preset command automatically selects known values for all front panel functions. An autoset command automatically optimizes front panel functions values for a repetitive input waveform.

Save/recall front panel setups: the ability to save and recall often-used front panel setups is another important convenience feature. It saves time in re-selecting function values, makes measurements more repeatable, and reduces operator error.

Direct output to hardcopy device: an output which interfaces directly to an X-Y recorder or digital plotter is an important convenience feature, particularly when a measurement setup does not include a controller.

Programmability/Systems Features

Data output capability: when it is necessary to process stored waveform data by computer, some form of digital data output is essential. It is helpful if front panel settings can also be transferred to a computer, to eliminate the need for entering these values manually and the associated increased chance for error.

Full programmability of all functions: as an enhancement to the systems capability of a waveform recorder, full programmability of front panel settings makes modification of these values very convenient.



- Fully programmable via HP-IB
- Convenient for benchtop measurements

- 20 MHz maximum sampling, 10 bit resolution
- Excellent dynamic performance

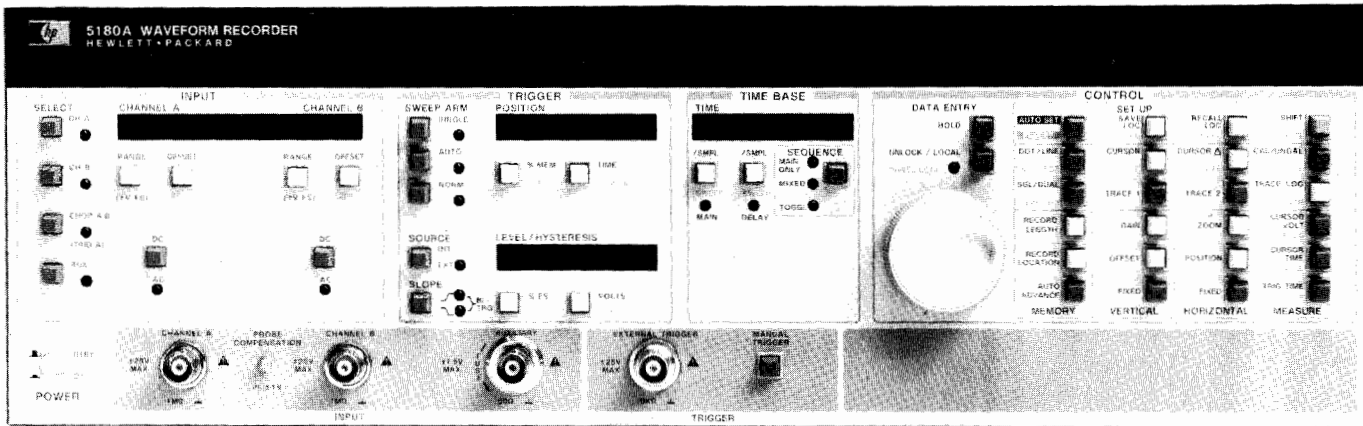

Introduction

Hewlett-Packard's new waveform recorder, the 5180A, samples analog signals at a maximum rate of 20 MHz, and converts these samples to digital form. Thus, the 5180A is like a 3-digit voltmeter, taking up to 20 million readings per second, and storing 16 thousand of the resulting digital values in memory. The 5180A's versatile feature set makes this data convenient to record, and improves reliability of the results.

Dynamic Performance

The 5180A Waveform Recorder offers superb dynamic performance, which is specified in the instrument's data sheet. Hewlett-Packard's 5 GHz integrated circuit process makes this exceptional dynamic performance possible. The hybrid IC's used in the 5180A provide accurate representations of input waveforms, reliability, and confidence.

Input Channels

The 5180A has two high-impedance input channels, A and B, and a third "auxiliary" 50 ohm input channel. Either the A or B channel used alone allows sampling at a maximum 20 MHz rate, or the two channels will alternate sampling in chop mode, with a maximum sampling rate of 5 MHz per channel. The auxiliary channel offers up to 20 MHz sampling rate.

Literature Available for 5180A Waveform Recorder

5180A Data Sheet (Pub. 02-5952-7626) 20 pp.
 5180A Brochure (Pub. 02-5952-7644) 4 pp.
 PN 5180-1 *Understanding the 5180A Waveform Recorder* (Pub. 02-5952-7623) 60 pp.
 PN 5180-2 *Dynamic Performance Testing of Analog to Digital Converters* (Pub. 02-5952-7629) 48 pp.
 PN 5180-3 *General Purpose Subroutines for the 5180A Waveform Recorder (using the 9825 controller)* (Pub. 02-5952-7643) 48 pp.
 AN 313-1 *Troubleshooting Microprocessor-Based Systems Using the 5180A Waveform Recorder and a Logic Analyzer* (Pub. 02-5952-7634)
 AN 313-2 *Using the 5180A Waveform Recorder with a Spectrum Analyzer for new Time-Domain Measurement Capability* (Pub. 02-5952-7635)
 AN 313-3 *Using the 5180A Waveform Recorder to Measure Microwave VCO Settling Time and Post Tuning Drift* (Pub. 02-5952-7636)
 AN 313-4 *Extending the Frequency Range and Increasing the Effective Sample Rate of the 5180A Waveform Recorder* (Pub. 02-5952-7637).
 AN 313-5 *Power Supply Testing with the 5180A Waveform Recorder* (Pub. 02-5952-7647).
 AN 313-6 *Recording Sonar and Other Signals Using the 5180A's Toggle Mode* (Pub. 02-5952-7641).
 AN 313-7 *Interconnecting Two or More 5180A Waveform Recorders to Obtain Multiple Input Channels* (Pub. 02-5952-7670) 19 pp.
 AN 313-8 *Using the Direct Memory Access Capability of the HP 5180A Waveform Recorder with the HP 9826 Desktop Computer* (Pub. 02-5952-7710) 21 pp.
 AN 313-9 *Using the 5180A Waveform Recorder to Evaluate Floppy Disc Media and Drive Electronics* (Pub. 02-5952-7701) 43 pp.
 Programming Note 5180A/9825-1 *Introductory Operating Guide for the 5180A Waveform Recorder with the 9825 Desktop Computer* (Pub. 02-5952-7630).
 Programming Note 5180A/85-1 *Introductory Operating Guide for the 5180A Waveform Recorder with the HP 85 Personal Computer* (Pub. 02-5952-7633).
 Programming Note 5180A/9826-1 *Introductory Operating Guide for the 5180A Waveform Recorder with the 9826 Computer System* (Pub. 02-5952-7664).
 5180A Waveform Recorder, Series 200 *Technical Computers Exchange Library Software Catalog* (Pub. 02-5952-7688) 9 pp.

Input voltage range is selectable for the A and B channels independently, between ± 100 mV and ± 10 V. In addition, voltage offset may be added to the input signal. The available offset range is the same as the selected input voltage range. Since it has no input amplifier, the auxiliary channel input voltage range is ± 1 V. This channel inputs directly to the ADC, and consequently has slightly better accuracy than either high impedance channel.

Triggering

Trigger level in the 5180A is precisely selectable in digital form; a digital readout on the display indicates the currently selected trigger level. In addition, the trigger slope may be rising, falling, or bi-directional. Triggering may be based on the input waveform (internal), or an external trigger source may be supplied.

The 5180A uses a precise digital trigger when internal triggering is selected. This trigger compares the selected trigger level (in 10-bit digital form) to the 10-bit output of the ADC following each waveform sample. The first waveform sample meeting triggering conditions becomes the trigger point. In addition, digital triggering makes selectable hysteresis possible. By specifying an appropriate hysteresis region, triggering on noise can be eliminated, which allows extremely reliable triggering.

Another triggering feature provided by the 5180A is pre- or post-trigger recording. At the time of the trigger, the 5180A is capable of saving up to 100% of the waveform data which is already

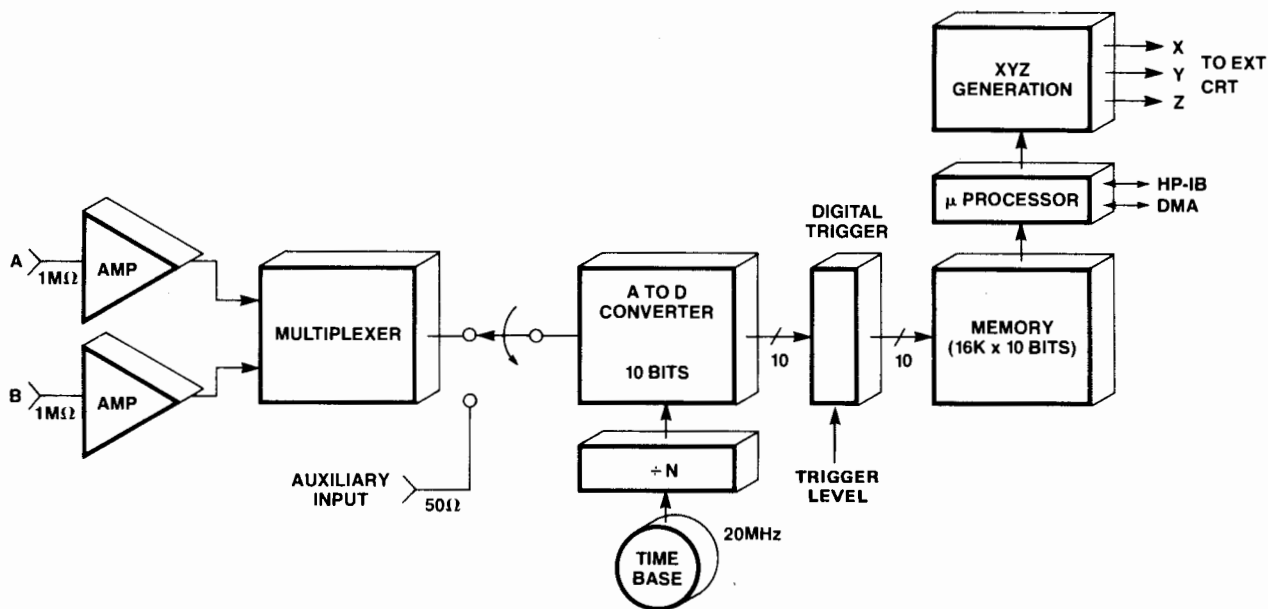

Available inputs to the 5180A include two high impedance input channels with selectable voltage ranges. In addition, the 5180A offers a 50 ohm auxiliary input, which sends signals directly into the ADC.

The 5180A's signal sampling rate is obtained by selecting the value of N which will divide down the 20 MHz internal timebase. The 5180A determines the trigger point by comparing the selected trigger level to the output of the ADC.

When data has been placed in the 5180A's memory, it can be output in digital form via HP-IB or direct memory access (DMA), or in analog form via XYZ outputs.

stored in memory. This "pre-trigger" feature makes it possible to record waveform information such as the initial rise of a transient which occurs before the trigger. If, on the other hand, a convenient trigger signal occurs some time before recording should begin, the "post-trigger" feature enables the 5180A to wait for a precise amount of time after the trigger before starting to save data. This precise delay may be as long as 1 million sample time intervals.

Memory

Two timebases, main and delay, allow the 5180A to change sampling rate once or twice during a recording. The 5180A can sample at the main timebase rate only, or switch from the main rate to delay rate, or from main to delay and back to main while recording into each memory record. The main and delay timebase rates are independently selectable, between 50 ns/sample (20 MHz rate) and 50 ms/sample (20 Hz rate).

The 5180A provides 16K words of high-speed memory. For the maximum 20 MHz sampling rate, this allows a total recording time of 819 μ s. If the entire memory is not required for a single waveform, the memory may be segmented into as many as 32 separate records.

When the memory is segmented into multiple records, a special feature of the 5180A enables it to automatically move to the next memory record when it has filled the current one. This feature, "auto advance", makes it possible to quickly record successive signals, and to record multiple signals when the 5180A is unattended. In addition, the "trigger time" of each successive record is available with respect to a user-selected zero time.

Display Features/Benchmark or Manual Measurements

Two cursors are available on the 5180A. These can be used to make voltage and time difference measurements, and to select points around which to expand either horizontally or vertically in the display. The 5180A has two display traces, each of which can display the waveform from a single memory record. When both traces are used, both cursors may be placed on one trace, or they may be placed on separate traces.

Operating Convenience Features

The 5180A's "Preset" key sets all front panel functions to known values. These values were selected to be optimal for recording tran-

sients about which little information is available. An "Autoset" key selects front panel function values for a repetitive input waveform. Often-used front panel setups can be stored in the 5180A's four "Save Locations" and later conveniently recalled for use.

Another convenience feature offered by the 5180A is direct HP-GL output to digital plotters as well as analog output to X-Y recorders. These hardcopy devices need only be connected by cables; no controller is required.

Programmability/Systems Features

The 5180A's front panel function values are fully programmable via HP-IB. Digital data may be output from or input to the 5180A in either binary or ASCII via HP-IB. Also, high-speed digital data transfer is available using direct memory access (DMA).

External Timebase Input

An external timebase signal between 1 and 20 MHz may be input to the 5180A and used instead of the instrument's 20 MHz internal timebase. This feature makes it possible to synchronize sampling with another signal, or to lengthen the 5180A's minimum sample interval from 50 ns to up to 1 second. The external timebase capability is also useful in a number of other applications, including:

Effective sample rates up to 20 GHz for repetitive input waveforms: a technique similar to that of a sampling scope enables the 5180A to "step through" an input waveform, obtaining high effective sample rates on waveforms containing frequencies up to 70 MHz.

Increasing number of input channels using multiple 5180A waveform recorders: samples from several 5180A Waveform Recorders may be synchronized by driving the external timebase inputs using synchronous sources.

Increasing real sample rates using more than one 5180A waveform recorder: to obtain real sampling rates higher than 20 MHz, even for transient waveforms, samples of the waveform taken by more than one 5180A may be interleaved.

Recording "Burst" data using a precisely controlled timebase input: by using a "burst" timebase input to a 5180A Waveform Recorder, data which occurs in bursts may be recorded without wasting memory space.



WAVEFORM RECORDERS

Waveform Storage/Display Modules

Models 5181A

179



- Display waveforms recorded in 5180A memory
- Permanently record digitized waveforms on tape

Summary of 5180A Specifications*

Channel A and B Inputs

Input voltage range: ± 100 mV to ± 10 V.

Input offset voltage: \pm selected Voltage Range.

Amplifier bandwidth (-3 dB): dc to 40 MHz (dc coupling).
10 Hz to 40 MHz (ac coupling).

Input impedance (NOMINAL): $1\text{ M}\Omega \parallel 40\text{ pF}$ (10 V range).
 $1\text{ M}\Omega \parallel 35\text{ pF}$ (other ranges).

Damage level: ± 12 V above 1 kHz.

Dynamic Performance

	Voltage Range	Input Signal	Test Frequency	
			1 MHz	10 MHz
Fourier Transform (unwanted signal level)	± 1 V	2 Vp-p	≤ -50 dBc	≤ -46 dBc
Differential Nonlinearity	± 1 V	2.2 Vp-p	≤ 3 LSB	≤ 4 LSB
Missing Codes	± 1 V	2.2 Vp-p	None	None
Effective Bits	± 1 V	2 Vp-p	≥ 7.8 bits	≥ 7.5 bits
S/N Ratio	± 1 V	2 Vp-p	≥ 48.6 dB	≥ 46.8 dB

Auxiliary Input

Input voltage range: ± 1 V

Amplifier bandwidth (-3 dB): dc to 70 MHz

Input impedance (NOMINAL): 50 Ω

Damage level: ± 1.5 V

Triggering

Internal trigger: level selectable over input voltage range.

External trigger: level selectable over ± 2.5 V range.

Trigger position: -100% to +9999% of memory.

Timebase

Internal timebase: 20 MHz internal timebase allows sample rates between 50 ns and 50 ms in a 1-2-5 sequence.

External timebase: external timebase signals between 1 MHz and 20 MHz may be used.

Memory

Size: 16,384 words.

Bits/word: 10 bits.

Segmentation: memory may be divided into 1, 2, 4, 8, 16, or 32 equal-length records.

Outputs

XYZ CRT monitor outputs: X, Y deflection voltages (NOMINAL) -1 to 0V into 50 Ω . X requires 1 MHz bandwidth input; Y requires 5 MHz bandwidth input. Z voltage (NOMINAL) is 0 to 2 V into 1 K Ω (0 to 1V into 50 Ω), selectable positive or negative going blanking pulse. Z requires 1.25 MHz bandwidth input.

HP-IB: all front panel function values selectable via HP-IB. Data I/O in ASCII or binary; maximum 3 Kbyte/second rate, depending on controller. "Talk only" to HP-GL plotters available even if no controller is used.

DMA: direct memory access allows fast parallel data transfer; maximum 1M word/second, depending on controller.

Trigger output: positive going signal from -0.6 V to 0 V into 50 Ω synchronous with 5180A trigger.

General

Operating temperature: 0°C to 55°C.

Power requirements: 100/120/220/240 volts +5%, -10%; 48 to 66 Hz. Max power dissipation 400 VA.

Weight: 22 kg (48 lbs.) net; 25 kg (53 lbs.) shipping.

Size: 142 mm H x 426 mm W x 574 mm D (5 $\frac{5}{8}$ " x 16 $\frac{3}{4}$ " x 23").

Accessories

10871A Service Kit (for 5180A)

10872A Parallel Interface (DMA Interface for use with 5180A and 9825/35/45 controller)

10873A Rack Mount Kit (for 5180A)

10874A Slide Mount Kit (for 5180A)

10875A 4.8m DMA Cable

10875B 1.0m DMA Cable

Option 910: Additional Manual

* See 5180A Waveform Recorder Data Sheet for more information.

5180A Waveform Recorder

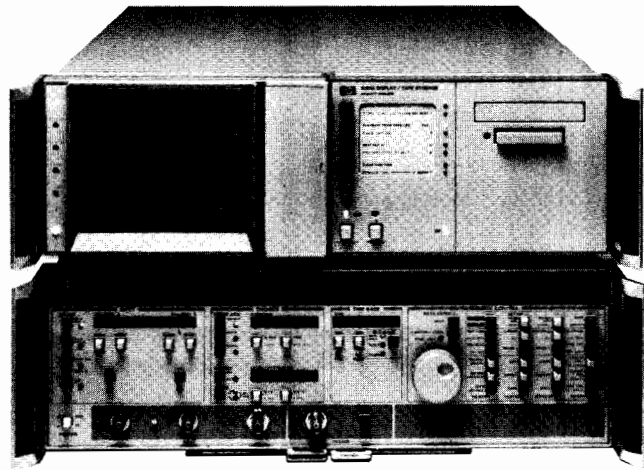

5181A, companion instrument to 5180A Waveform Recorder, shown with 5180A



5181A Display/Tape Storage Module

Introduction.

The 5181A Display/Tape Storage Module, a companion instrument to the 5180A Waveform Recorder, provides a high resolution CRT for waveform display and a dedicated controller for recording digitized waveforms onto magnetic tape.

The display portion of the 5181A uses an HP 1332A Small Screen Display. The controller is an HP 9915A Modular Computer with special front panel keys which enable data transfer (between the 5180A and the 5181A) and data storage.

When waveform data is sent to or from the 5180A, the 5181A also transfers the current complete 5180A front panel setup, so that the conditions used for recording each waveform are saved along with the waveform. Digitized waveforms which have been stored on tape by the 5181A may be read directly by an HP 9915A, HP 85, HP 9835, or HP 9845 controller for custom data analysis.

5181A Specifications

Data Storage

Tape Capacity: four 16,384-word files per tape, plus space for up to 128 complete front panel setups.

Display

Viewing area: 9.6 x 11.9 cm.

Quality viewing area: 8.5 x 10.8 cm.

Spot size: ≤ 0.30 mm within quality viewing area.

Resolution: 31.5 lines/cm.

General

Operating temperature: 0° to 55°C*.

Power requirements: 100/120/220/240 volts + 5%, -10%, 48-66 Hz. Maximum Power Dissipation: 100 VA.

Weight: 14.9 kg (32 lbs., 12 oz.) net.

Size: 142 mm H x 426 mm W x 574 mm D (5 $\frac{5}{8}$ " x 16 $\frac{3}{4}$ " x 23").

Options

(includes handles)

Option 908: Rack Mount Kit (for mounting without handles)

Option 913: Rack Mount Kit (for mounting with handles)

*Tape cartridges are not recommended for use above 40°C.

5181A Display/Tape Storage Module

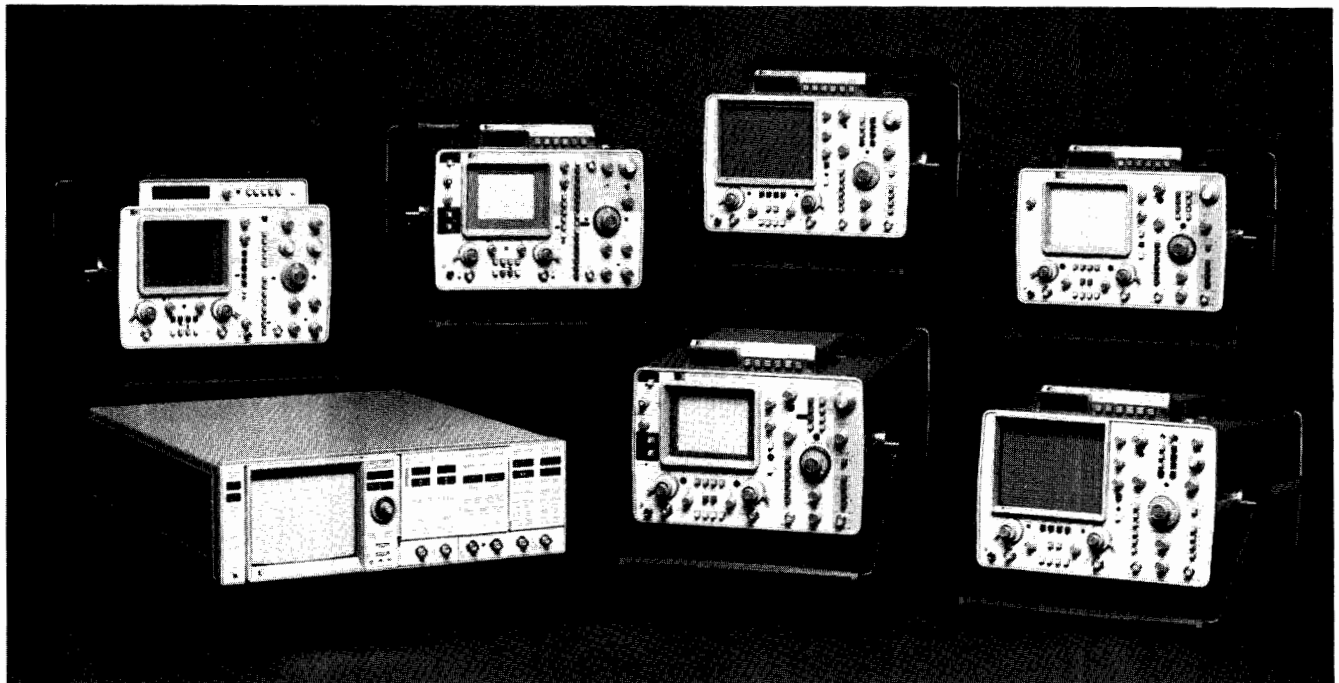

An oscilloscope is the most general purpose tool of the electronics industry, providing measurement results in research and development labs, production, and service applications. Whether you need a general-purpose 100 MHz oscilloscope, an automatic measurement system, or a high frequency oscilloscope with picosecond accuracy, Hewlett-Packard provides the oscilloscopes and measurement systems to solve your application problem.

Selecting an Oscilloscope

When selecting an oscilloscope, you will need to match your present and future measurement needs with the oscilloscope feature set. Price is always a consideration and incremental cost must be weighed against incremental measurement capability. In many cases, ease-of-use should be considered along with measurement accuracy and the overall feature set. Some of the major feature decisions include:

- Bandwidth
- Number of channels
- Rack or cabinet configuration
- Portability
- Plug-in versatility
- Vertical and horizontal accuracy
- Convenience
- Price
- Time interval capability
- Variable persistence storage
- HP-IB programmability
- Digital waveform storage

Low Frequency

Low frequency oscilloscopes, such as HP's 1200B and 1201B with 500 kHz bandwidth, are used in education, medicine, system monitors, engineering, production, and some field service applications. The 1200 series oscilloscopes offer 100 μ V and 5 mV sensitivity, dif-

ferential inputs, solid state, and lightweight construction, as well as reliable operation.

The 1700 Family

The 1700 family of oscilloscopes provides a wide selection of quality instruments for lab, production, and service applications. The product line is composed of oscilloscopes ranging in bandwidth from 100 to 275 MHz, with both conventional and variable persistence/storage CRTs available in each bandwidth category.

The 1740 Series

This series offers a selection of five oscilloscopes in the 100 MHz category; 1740A, 1741A, 1742A, 1743A, 1744A, 1745A, 1746A. All of the 1740 series are dual channel, offer a third channel trigger view, vertical sensitivity to 1 mV (at reduced bandwidth), as well as selectable input impedance (50 Ω /1M Ω). Models 1741A and 1744A offer the additional capability of variable persistence/storage.

Large Screen 1740's

The 1745A and 1746A offer a large screen 9.5 x 12 cm CRT which has 43% more viewing area than the standard 8 x 10 cm CRT. The trace is crisp and bright as in the 1740A which increases resolution for more accurate measurements, especially in three-channel timing measurements with trigger view. The large screen also enhances the viewability of the screen, providing more of what an oscilloscope is used for—seeing a picture of what is happening in the circuit.

High Frequency 1700's

For high frequency applications, there is a selection of four oscilloscopes ranging from 200 to 275 MHz with both conventional and variable persistence/storage CRTs: 1715A, 1725A, 1722B, 1726A, and 1727A. These instruments are all delta time oscilloscopes, which are ideal for use in the design, manu-

facture, and testing of high speed computers, peripherals with fast interface logic, high speed digital communications, and high frequency RF and analog applications.

Variable Persistence/Storage

The 100 MHz 1741A and 1744A combine with the 1727A to form an excellent choice of variable persistence/storage oscilloscopes. All three offer an auto-intensity circuit that minimizes concern of CRT damage during operation. The 1744A and 1727A provide extremely fast variable persistence and stored writing speeds.

Precision Time Interval

In addition to the standard delta time oscilloscopes available, HP also offers the 1726A and 1743A, which provide highly accurate time interval measurements plus convenient operation.

1700 Series Options

DMM/Temperature Probe—DMM and temperature probes are available for the 1740A, 1741A, 1715A, 1725A, and 1727A. A 3½ digit auto-ranging and auto-zeroing DMM built into the top cover of the instrument can display time intervals on delta time oscilloscopes, as well as supply the five basic measurements: ac and dc volts, ac and dc current, and resistance. By adding a Model 10023A Temperature Probe to the DMM, fast, accurate temperature measurements are accomplished easily with its "pencil-like" tip that easily accesses components.

TV Sync—Hewlett-Packard's Option 005 offers triggering capability on composite video waveforms that have negative sync pulses. The option features a variety of display enhancements including field selection, line scan, and single line scan. This option is available on the 1740A, 1741A, 1715A, 1725A, 1745A, and 1746A.



The 1980 System

HP's 1980 system integrates a programmable oscilloscope, waveform digitizer, universal counter, and programmable analog comparators to provide versatile measurement capability. Combining these instruments into a single measurement system not only reduces your test system assembly time, but it also increases the quality of measurements and saves money by reducing the number of instruments you need to purchase. Linked together with HP's computers, software, and support, the 1980 system increases the productivity of developing, maintaining, and operating test systems.

Fully Programmable

The entire 1980 system is fully programmable over HP-IB, HP's implementation of the IEEE-488 standard. In addition to programmable hardware, the 1980 system includes software support and documentation, simplifying the integration of the 1980 into a test system. HP supplies a complete line of HP-IB programmable instruments so that a system can be developed in the shortest amount of time.

Versatile Measurement Capability

The various components of the 1980 system together provide a very extensive set of time-domain measurement capabilities. There are two main categories that the 1980 system can make—characterization and comparison. The system can characterize waveform parameters including peak-to-peak voltage, rms voltage, frequency, pulse width, and rise and fall times. The system also performs waveform comparison, a measurement technique that allows a waveform to be tested against specified tolerance limits. The 1980 system's flexible measurement capability can improve the quality of measure-

ments in automatic, semiautomatic, and manual environments.

Application Software

HP's Waveform Measurement Library consists of three parts that together reduce software development time. This software provides first-day measurement programs, a flexible subprogram structure, and easy to use tools for developing specific application programs. Other HP software products can extend the system's measurement capabilities.

HP Computers

With large memories, powerful high-level language, mass storage, and versatile I/O, HP's computers offer a variety of price/performance solutions. Coupled with the 1980 system, they provide a friendly environment in which to solve measurement problems.

Product Support

HP's complete product support allows you to access the capabilities of the 1980 system quickly and effectively. This support exists in the form of literature, seminars, and HP's System Engineering Organization. By combining all of these elements into the 1980 system, HP offers complete waveform measurement solutions.

HP's Total Solution

Manufacturers of electronic products working with HP can quickly increase the productivity of their test systems. Along with the 1980 system, HP manufactures a complete line of electronic test equipment and computers to solve testing problems. HP also provides seminars, literature, and system engineering services for complete post-sales product support. In addition, HP computers can share data and programs, further increasing productivity.

HP's concept of a Manufacturer's Productivity Network allows the integration of all information of the manufacturer's operations. This information can be distributed to any department within a company so that decisions can be based on accurate, up-to-date data. For example, programs, measurement results, and waveforms from a test system can be accessed by several departments in a company, eliminating redundant testing between departments. Tests made on parts in incoming inspection could be accessed by an R&D team to evaluate parts for future products. A quality assurance department could perform statistical analysis on waveforms and measurement results obtained on a production line. Production engineers could access programs developed by R&D engineers for testing prototypes. This increases the quality of a manufacturer's products and the productivity of a manufacturer's resources.

Probes

Probing is an extremely important and often overlooked part of making a measurement. Hewlett-Packard offers a full line of probes to complement HP oscilloscopes for maximum signal fidelity and minimum circuit disturbance.

For IC probing in densely packed printed circuit boards, HP offers miniature probes in high impedance and 50 Ω versions. These small, lightweight probes fit in the hand much like a pencil and easily clip on IC pins. Also, the 10024A IC test clip clamps on 14- or 16-pin DIP's for easy access with the miniature probes.

In addition, HP offers passive resistive divider, active, current, and logic triggering probes to meet your measurement needs fully.

Reliability/Quality

Hewlett-Packard oscilloscopes maintain the high standard of quality that is present throughout the company. Two programs ensure that this quality remains an integral part of Hewlett-Packard oscilloscopes: 1) an overall reliability program and 2) an internal quality program.

The overall reliability program stresses "designing in reliability." This comprehensive program starts at the lab prototype stage, where temperature and environmental tests identify marginal components and even potential design problems. The program continues throughout the entire development cycle of a product and ends with a full environmental and life test prior to release.

The internal quality program emphasizes "do it right the first time" and affects all areas of operation: production, shipping, order processing, service, and the lab.

In production, quality starts with the inspection of incoming parts. Printed circuit boards go through extensive testing including functional and parametric component testing, power cycling to weed out early failures and to increase the reliability of the boards going to final assembly. There, quality teams monitor assembly and calibration procedures to ensure that HP oscilloscopes maintain their reputation for high quality.



OSCILLOSCOPES

Oscilloscope Measurement System

Models 1980A/B, 1965A, 19860A, 1950A, 19800/19801

- Fully HP-IB programmable
- Digital waveform storage
- Gated universal counter
- Application software
- Front panel calibration
- Auto-scope automatically scales waveforms
- CRT test for operator instructions
- Two-channel expansion module

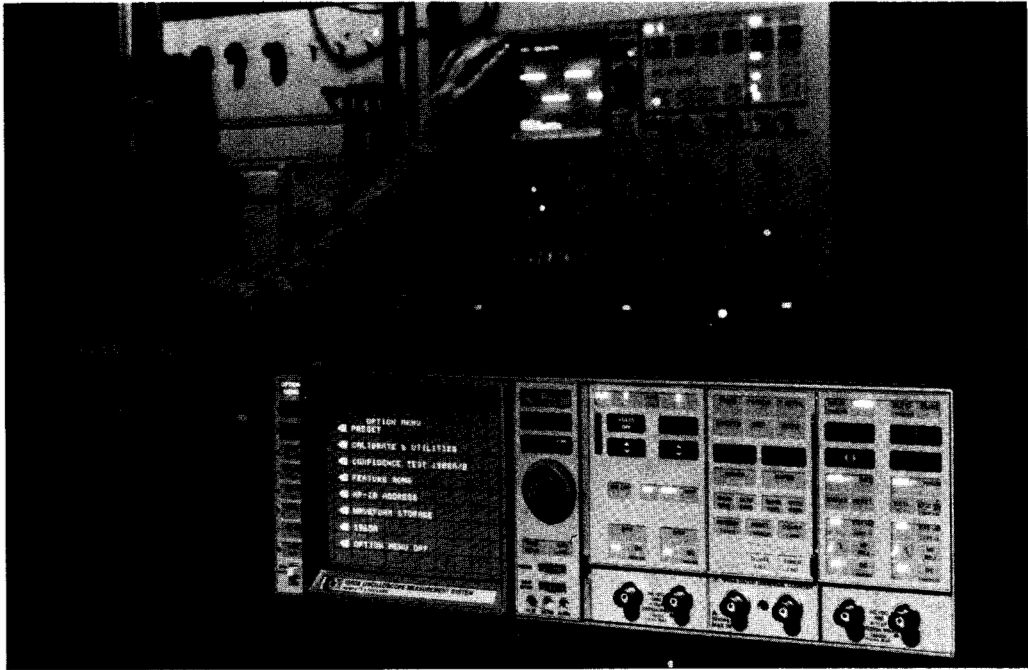

The 1980 System Description

In the 1980 system, Hewlett-Packard has integrated many components that together provide complete waveform measurement solutions.

HP's 1980 system combines a programmable oscilloscope, waveform digitizer, universal counter, and programmable analog comparators to provide versatile measurement capability. Combining these instruments into a single measurement system not only reduces your test system assembly time, but it also increases the quality of measurements and saves money by reducing the number of instruments you need to purchase. Linked together with HP's computers, software, and support, the 1980 system increases the productivity of developing, maintaining, and operating test systems.

The 1980A/B Oscilloscope Measurement System

The 1980A/B Oscilloscope Measurement System is a fully HP-IB programmable, two-channel, 100 MHz oscilloscope. It features continuously-calibrated verniers, with 2 mV/div deflection factors and two independent 5 ns/div sweeps. Measurement capabilities can be expanded by adding internal options and plug-in expansion modules. In addition, the 1980 has these special features:

*The Auto-Scope function autoranges trigger levels, deflection factors, and sweep speeds to display input signals. It provides a one key-stroke setup for most signals.

*Continuously calibrated verniers replace the standard 1-2-5 vernier sequence, providing exceptional versatility in viewing and measuring time-domain waveforms.

*Save/Recall registers can be used to save up to eight complete instrument states for recall in repetitive measurement procedures.

*Calibration can be performed on-site without removing covers and requires little or no test equipment. Internal reference signals are provided and complete, step-by-step instructions are displayed on the CRT.

The 1950A Two-Channel Expansion Module

The 1950A adds two 100 MHz vertical channels to the 1980. It features continuously-calibrated variable deflection factors from 2 mV/div to 10 V/div and a delta voltage function.

The 1980's Trigger Flag

Trigger Flag, a standard measurement feature of the 1980, accesses the 1980's trigger circuits and uses them as programmable analog trigger comparators to make static and dynamic tests. It can make a variety of measurements, including voltage and timing tolerances tests, random noise tests, envelope and burst measurements, and static-state testing.

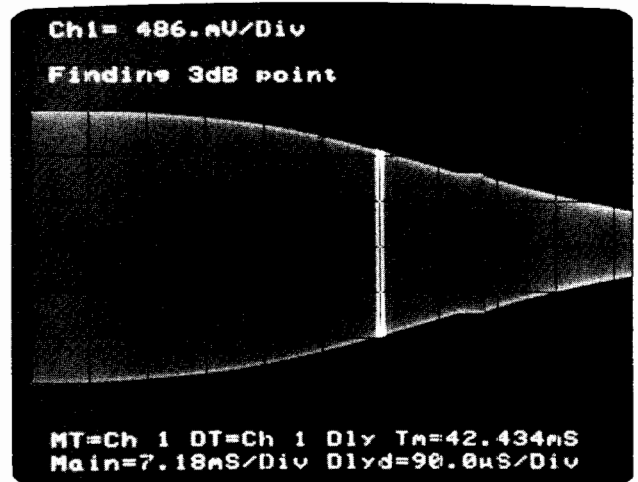

Trigger Flag characterization—using the 1980's analog trigger comparators for measurements avoids some problems associated with digitizers. For example, Trigger Flag avoids the aliasing problems common to waveform digitizers. This photo shows an example of a measurement taking advantage of this feature. After characterizing the Trigger Flag's gain response, the system can rapidly locate the -3 dB point in the swept response of a network. The frequency at the -3 dB point can then be measured using the HP 1965A's gated frequency measurement capability.

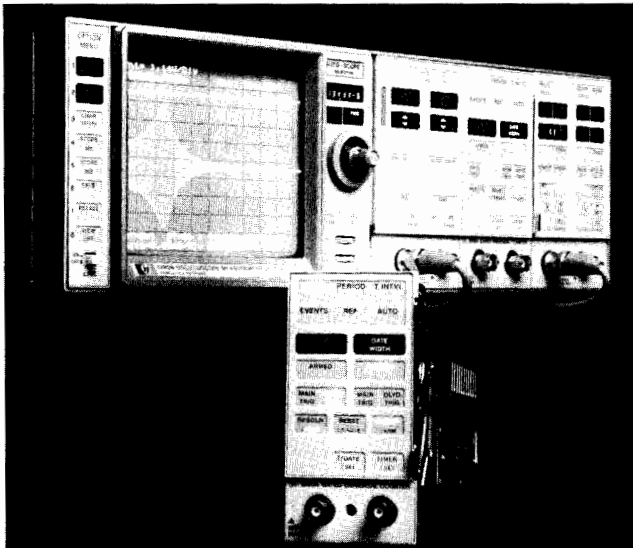

The 1965A Gated Universal Counter Expansion Module

The 1965A adds a fully programmable, 100 MHz universal counter to the 1980 system. By merging oscilloscope and counter technologies, the 1965A makes counter measurements (i.e., frequency, period, time interval, and events) and automatic pulse parameter measurements (i.e., rise/fall time, pulse width, duty cycle, propagation delay, and phase shift) with accuracy up to 500 picoseconds and ± 10 picosecond resolution. The 1965A simplifies measurements requiring complex gating or triggering by using the 1980's vertical signal conditioning, time bases, and trigger circuitry.

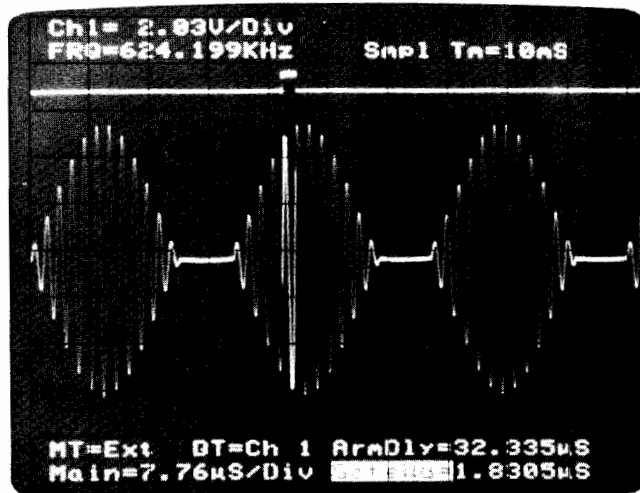

1965A time interval measurement—the 1965A with its flexible gating capability can easily make measurements on bursts. This photo shows a burst frequency, which is often required in radar and sonar applications. Another type of burst measurement that the 1965A can make is the time interval between an original and a reflected burst. Time-domain reflectometry and surface acoustical wave technologies require this kind of precision time interval measurements.

The 19860A Digital Waveform Storage

Internally installed in the 1980, the 19860A adds digital waveform storage to the system. The 19860A can digitally store up to two waveforms with 10-bit vertical resolution over the entire 100 MHz bandwidth of the 1980. Waveforms are acquired in single-shot mode (sampling rate is 50 k-samples/second) or repetitive mode (100 MHz bandwidth). Additional flexibility is provided through programmable sample density and averaging.

The Waveform Measurement Library

HP's 19800A/B and 19801A/B/C Waveform Measurement Library (i.e., Series 1980 application software) automates time-domain measurements. The software consists of first-day measurement capability, a flexible subprogram structure, and easy to use tools for developing specific application programs. Other HP software products can extend the system's measurement capabilities. For example, the Waveform Analysis Package when used with the Waveform

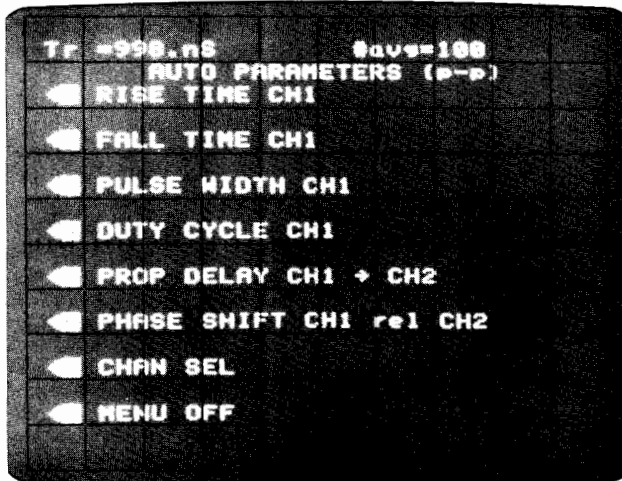

Many applications require waveforms to be characterized for basic time interval measurements. For productivity and convenience, these time interval measurements can be accessed through the front panel or through one HP-IB command. The 1965/1980 then finds the absolute maximum and minimum values, sets the trigger levels (e.g., 10% and 90%), and measures the time interval.

19860A waveform comparison—the photo to the right shows a limit waveform, generated by the Waveform Measurement Library, based on a reference or known good waveform. Waveforms from units under test can then be compared to the limit waveform. This avoids measuring every waveform parameter and allows the computer to make qualitative decisions traditionally made by an oscilloscope's operator.

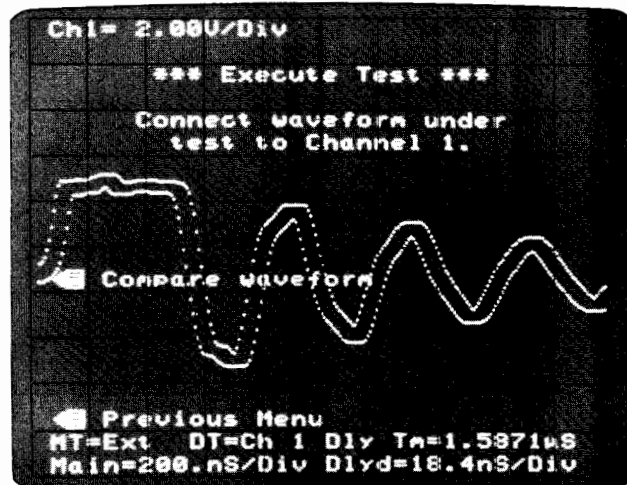



OSCILLOSCOPES

Oscilloscope Measurement System

Models 1980A/B, 1965A, 19860A, 1950A, 19800/19801 (cont.)

Measurement Library can perform fast Fourier transforms on the waveform data captured by the 1980 system.

By performing waveform characterization and waveform comparison, this software provides an extremely versatile set of time-domain measurements. With the software package, the 1980 system can automatically characterize waveform parameters such as peak-to-peak voltage, rms voltage, frequency, pulse width, rise time, and fall time. Waveform comparison is a measurement technique that allows a computer to perform qualitative time-domain measurements. To perform a waveform comparison, the waveform must be compared to limits established for it. These limits can be derived from an ideal waveform generated by a computer or from a known "good" waveform. In this way, the computer, not the operator, can make the necessary judgements.

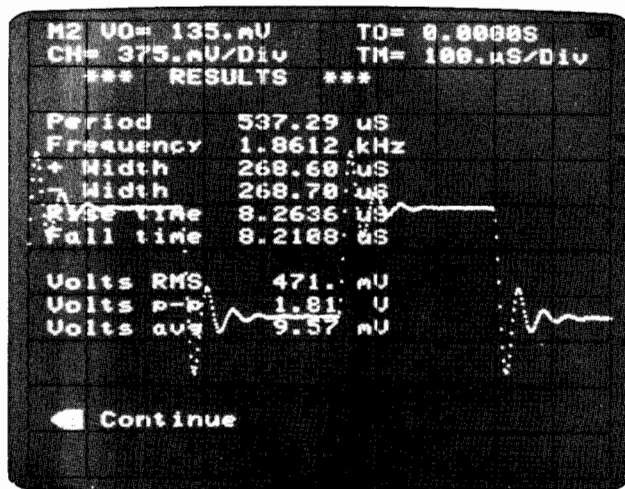

19860A waveform characterization—the 19860A Digital Waveform Storage option and the HP Waveform Measurement Library can automatically characterize waveform parameters. This photo shows measurement results from the first-day Automatic Waveform Measurement Program. The program accounts for the ringing on the waveform when measuring parameters such as rise time and fall time. This program provides first-day measurement results without requiring any additional programming.

1980 System Accessories

HP provides several accessories for the 1980 system. The 19811A Plot/Sequence ROM memorizes up to 6 sequences of 25 keystrokes that are executed when enabled. Any key sequence can be initiated when you press a push button on a 1008XA probe (the push button for the 10085A probe is located at the probe tip), send a command over HP-IB, or set a timer in the 1965A. Additionally, the 19811A can send waveforms stored by the 19860A to a plotter in stand-alone configurations. A complete line of testmobiles and miniature probes is also available.

Improving Quality Through HP Automation

A test system based on the 1980 System and an HP computer can improve the quality of time-domain measurements. For example, the computer can automatically set up the 1980's front panel, eliminating operator errors. Measurements usually made by counting graticule lines can be made without operator intervention. In addition, the computer can make comparison measurements on waveforms, maintaining quality and reducing the required skill level of the operator. HP's Waveform Measurement Library is the software that accesses these capabilities to improve the quality of measurements.

1980 SYSTEM - CORE OF A TEST SYSTEM

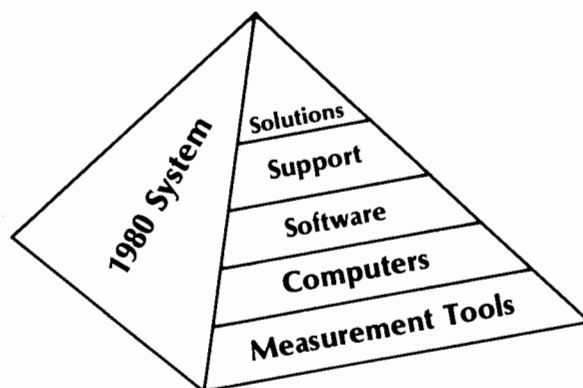

The 1980—A Test System's Central Measurement Device

The various components of the 1980 system together provide a very extensive set of time-domain measurement capabilities. There are two main categories of measurements that the 1980 system can make—characterization and comparison. The system can characterize waveform parameters including peak-to-peak voltage, rms voltage, frequency, pulse width, rise time, and fall time. The system also performs waveform comparisons, a measurement technique that allows a waveform to be tested against specified tolerance limits. The 1980 system's flexible measurement capability can improve the quality of measurements in automatic, semiautomatic, and manual environments.

Increasing Test System Throughput

The productivity of a test system can be evaluated by its measurement throughput. There are several steps associated with a measurement: after a waveform from a unit under test is connected to a test system, the instruments must be set up to view or store the waveform. Next, the measurement tools gather and transfer data to a computer for analysis. Together, these steps determine the throughput of a system. Because the 1980 and an HP computer provide automatic setup, acquisition, and analysis capabilities, they can increase the throughput of your test system.

The 1980 system is designed to increase measurement throughput of systems in automatic, semiautomatic, and manual environments. The 1980 system is ideal for automatic applications, because it provides full programmability, flexible measurement capability, and the application software needed to automate time-domain measurements. In semiautomatic applications, the 1980 system with an HP computer can increase throughput by automatically setting up its front panel and guiding an operator through a test procedure via text on the CRT. Manual applications can also benefit from features such as Auto-Scope and Save/Recall registers.

HP's Complete Product Support

HP provides many services to help you be successful integrating the 1980 into a test system. In addition to product notes that discuss specific measurements, a Waveform Measurement Seminar is available that teaches you how to get the best results from the 1980 system. Also, HP's System Engineering Organization can provide consulting services and can help you to develop programs for your particular application.



1980A/B Specifications

Operating Modes

Voltage vs time (V vs T); channel 1 vs 2 (1 vs 2); monitor mode for logic state display with HP Model 1607A (X-Y-Z).

Vertical Display Modes (V vs T)

Channel 1; channel 2; channels 1 and 2 displayed on alternate sweeps (ALT); channels 1 and 2 displayed by switching between channels at approx 400 kHz rate with blanking during switching (CHOP); automatic selection of alternate for sweep speeds > 1 ms/div and chop for sweep speeds ≤ 1 ms/div (AUTO-CHOP/ALT); channel 1 plus 2 algebraic addition (1 + 2), channel 1 and/or 2 may be inverted; and either main or delayed trigger signal.

Vertical Amplifiers (2)

Bandwidth: 3 dB down from a 5 div reference signal (0° to +40°C).

DC-coupled: dc to 100 MHz in 50 Ω and 1 MΩ input modes.

AC-coupled: < 10 Hz to ≥ 100 MHz.

Bandwidth limit: limits upper bandwidth to approx 20 MHz.

Input coupling: ac, dc, 50 Ω (dc), ground. Ground position disconnects input connector and grounds amplifier input.

Input RC: ac or dc, 1 MΩ ± 2% shunted by approx 16 pF; 50 Ω (dc), 50 Ω ± 3%.

Maximum input voltage: 50 Ω, 5 V rms; 1 MΩ, ac or dc coupled, 250 V (dc + peak ac) at ≤ 1 kHz.

Deflection factor: range, 2 mV/div to 10 V/div; accuracy, ± 3%; 3 digits of resolution.

Vertical position: range, baseline can be adjusted ± 15 major div from center graticule line (possible 10 div off-screen); accuracy, ± (2% of reading + 0.3 major div).

ΔV (channel 1 or 2): range, ± 15 times the deflection factor selected for that channel; accuracy, ± 4% (for a Δ ≤ 10 major div).

Channel 1 + 2

Amplifier: bandwidth and deflection factors are unchanged.

Differential (channel 1-2 or channel 2-1): CMRR is at least 20 dB from dc to 20 MHz with common mode signal amplitude equivalent to 10 div and one channel adjusted for optimum rejection.

Trigger view: displays internal or external trigger signal for either main or delayed sweep.

Horizontal Display Modes (V vs T)

Main, main intensified, delayed, and dual. Dual simultaneously displays main intensified and delayed sweep.

Main and Delayed Time Bases

Range: 5 ns/div to 1 s/div; 3 digits of resolution.

Accuracy*

Speed	Accuracy*
5 ns/div to 9.99 ns/div (center 8 div)	± 3%
10 ns/div to 9.99 ms/div (first 10 div)	± 3%
10 ms/div to 1 s/div (first 10 div)	± 4%

*Within ± 10°C of the temperature at which the instrument was calibrated. For temperatures beyond the ± 10°C range and within 0° to +55°C, add 1% and 2% from 0.5 s/div to 1 s/div.

Sweep Delay

Time delay: range, 0 to 9.9999 s; resolution, displayed, 5 digits; HP-IB, 100 ps at any delay, possible 11 digits.

Accuracy*

Sweep Speed	Delay or Time Interval	
	< 200 μs	≥ 200 μs
5 ns/div to 9.99 ns/div	± (2 ns + 0.1% of reading)	± (0.05% of reading)
≥ 10 ns/div	± (2 ns + 0.1% of reading + 1% of dly'd s/div x 10 div)	± (0.05% of reading + 1% of dly'd s/div x 10 div)

*Within one hour of a delay self-calibration and in constant ambient temperature.

Delay jitter: 0.002% of delay time; at 10 MHz ± 10 kHz, 0.01% of delay time.

Time interval (ΔT): in intensified, dual, or delayed horizontal display modes, a zero time reference can be set anywhere in the delay range and a Δt measurement made from that point.

Resolution, accuracy: same as time delay.

Frequency (1/ΔT): calculates and displays reciprocal of time interval measurement; resolution, same as ΔT. As frequency increases, insignificant digits are truncated; accuracy, same as time delay.

Digital delay: range, 0 to 10⁶ - 1 events; resolution, 1 event; maximum rep rate, 15 MHz with a 50% duty cycle.

Triggering (main and delayed time bases)

Main Time Base

Triggered: specified level and slope generates a sweep.

Auto-triggered: baseline displayed in absence of a trigger signal; triggering is same as triggered above approx 10 Hz.

Single: sweep occurs once with same triggering as triggered mode.

Delayed Time Base

Auto-sweep after delay: delayed sweep starts at end of delay time.

Triggered sweep after delay: sweep can trigger after delay.

Digital delay: delayed sweep starts a specified number of events after start of main sweep.

Sources: selectable from channel 1, channel 2, enhancement module, or external. Line frequency triggering for main sweep only. Main and delayed independently selectable.

Internal Trigger Level

Range: ± 20 major divisions from center horizontal graticule line.

Resolution: 0.02 major divisions; coarse or fine slew rates.

Accuracy: ± (3% of reading + 0.4 major div).

External Trigger Level

Range: ± 1.2 V from ground reference; in ÷ 10, ± 12 V.

Resolution: ÷ 1, 2 mV; ÷ 10, 20 mV; coarse or fine slew rates.

Accuracy: ± (3% of reading + 40 mV); ÷ 10, ± (3% of reading + 400 mV).

Line Trigger Level

Range: ± 20 relative units.

Resolution: steps of 0.02; fine or coarse slew rates.

Slope: positive or negative slope within trigger signal range.

Sensitivity

Internal: < 10 mV/div, at least 1.4 div from dc to 25 MHz increasing to 3 div at 100 MHz; ≥ 10 mV/div at least 0.7 div from dc to 25 MHz increasing to 1.5 div at 100 MHz.

External: ÷ 10, at least 500 mV p-p from dc to 25 MHz increasing to 1.2 V p-p at 100 MHz; ÷ 1, at least 50 mV p-p from dc to 25 MHz increasing to 120 mV p-p at 100 MHz.

Coupling (internal and external): ac, attenuates signals < 10 Hz; dc, direct coupled; HF rej, attenuates signals above approx 35 kHz; LF rej, attenuates signals below approx 35 kHz.

External Trigger Inputs (main and delayed)

Input RC: ac or dc, 1 MΩ ± 2% shunted by approx 15 pF; 50 Ω (dc), 50 Ω ± 3%.

Maximum input voltage: 50 Ω (dc), 5 V rms; 1 MΩ, ac or dc coupled, 250 V (dc + peak ac) at ≤ 1 kHz.

1 vs 2 Operation

Bandwidth: Y-axis (channel 1), same as channel 1 in V vs. T; X-axis (channel 2), dc to 4 MHz.

Phase difference: ≤ 3° dc to 100 kHz.

Deflection factors: same as Vertical Amplifiers.

Cathode-Ray Tube and Controls

Type: post-accelerator, approx 22 kV accelerating potential, aluminumized P31 phosphor.

Graticule: 10 x 10 div internal graticule; 0.2 subdivision markings on major horizontal and vertical axes; 10 x 12 cm display area.

Trace and character intensity: adjustable in relative steps of 1 from 0 to 99.

General

Bus compatibility: as defined in IEEE Std 488-1978 is SH1, AH1, T5, TE0, L3, LE0, SR1, RL1, PP0, DC0, DT1, C0, and E2.



OSCILLOSCOPES

1980 System (cont.)

Models 1980A/B, 1950A, 1965A, 19860A, 19800/19801

1980A/B Specifications (cont.)

Power: 100, 120, 220, 240 Vac, +5 to -10%; 48 to 440 Hz; 300 VA max with expansion module and plug-in ROMs, standard, 200 VA max.

Weight: net, approx 18.2 kg (40 lb). Shipping, approx 24.1 kg (53 lb).

Dimensions: (1980A) 278 H x 213 W x 543 mm D (10.9 x 8.4 x 21.4 in.); (1980B) 143 H x 427 W x 543 mm D (5.6 x 16.8 x 21.4 in.).

Operating environment: temperature, 0° to +55°C; humidity, to 95% relative at +40°C; altitude, to 4600 m (15000 ft); vibration, vibrated in three planes for 15 min each with 0.38 mm (0.015 in.) excursion, 10 to 55 Hz.

Accessories furnished: one blue light filter HP P/N 01980-02701; one 2.3 m (7.5 ft) power cord; one expansion module panel cover, HP P/N 01980-24106; two Operating/Programming Manuals; one service manual; one binder with divider tabs; two 10081A, 10:1 divider probes approx 2 m (6 ft) long.

1950A Specifications

Vertical Display Modes

Channels 3 and 4 independently selected; channel 3 vs 4; channel 3 + 4; either or both channels may be inverted.

Vertical Amplifiers

Bandwidth: same as 1980.

Input RC: same as 1980, channels 1 and 2.

Deflection factors: 2 mV/div to 10 V/div, ±3%, 3 digit resolution.

ΔV (Channel 3 or 4): same as 1980, channels 1 and 2.

General

Operating environment: same as 1980A/B.

Weight: net, approx 1.5 kg (3.3 lb). Shipping, 2.2 kg (4.8 lb).

Power: supplied by 1980.

Accessories furnished: one operating and service manual; two 10081A, 10:1 divider probes, approx 2 m (6.6 ft) long.

1965A Specifications

Frequency A

Range: 100 mHz to 100 MHz

Note: refer to Triggering for minimum pulse width requirements.

LSD Displayed: $\frac{10 \text{ ns}}{\text{sample time}} \times \text{frequency}$ (9 digits maximum)

Unarmed and Armed Modes

Resolution: $\pm/(2 \times \text{LSD}) \pm/1.4 \times \frac{\text{trigger error}}{\text{sample time}} \times \text{frequency}$

Accuracy: $\pm/\text{resolution} \pm/\text{time base error} \times \text{frequency}$

Gated Mode

Resolution: $\pm/\frac{\text{period resolution}}{\text{period}} \times \text{frequency}$

Accuracy: $\pm/\frac{\text{period accuracy}}{\text{period}} \times \text{frequency}$

** Refer to period—gated mode specifications.

Period A

Range: 10 ns to 10 s

LSD displayed: $\frac{10 \text{ ns}}{\text{sample time}} \times \text{period}$ (9 digits maximum)

Unarmed and Armed Modes

Resolution: $\pm/(2 \times \text{LSD}) \pm/1.4 \times \frac{\text{trigger error}}{\text{sample time}} \times \text{period}$

Accuracy: $\pm/\text{resolution} \pm/\text{time base error} \times \text{period}$

Gated Mode

Resolution: $\pm/\frac{10 \text{ ns} + (1.4 \times \text{trigger error})}{N \times \sqrt{\text{sample time}/(\text{period} \times N)}}$

Accuracy: $\pm/\text{resolution} \pm/(\text{time base error} \times \text{period}) + \frac{4 \text{ ns}}{N}$

Where N is the number of cycles gated per sweep.

Time Interval A-B

Range: $\pm/10 \text{ ps}$ to $\pm/10 \text{ s}$.

LSD displayed: $\frac{10 \text{ ns}}{\sqrt{(\# \text{ of averages})}}$

Number of Averages	LSD
1	10 ns
100	1 ns
10,000	100 ps
1,000,000	10 ps

Resolution: $\pm/\text{LSD} \pm/\text{start trigger error}/\sqrt{(\# \text{ of averages})}$

$\pm/\text{stop trigger error}/\sqrt{(\# \text{ of averages})}$

Accuracy: $\pm/\text{resolution} \pm/\text{time base error} \times \text{time interval}$

$\pm/\text{trigger level timing error} \pm/\text{systematic error}$

RATIO A/B

Range: 10E-9 to 10E9

Resolution: $\pm/\frac{\text{period B}}{\text{sample time}} \times \text{ratio} \pm/\frac{\text{trigger error}}{\text{sample time}} \times \text{ratio}$

Accuracy: same as Resolution

Events A (Gated)

Range: 0 to 1000 megabits

Events A During B

Range: 0 to 1000 megabits

Minimum time between B pulses: 75 ns

Totalize A

Range A: 0 to 1000 megabits

LSD: 1 count of input

Resolution: \pm/LSD

Accuracy: same as Resolution

Totalize A + B

Range: 0 to 2000 megabits

LSD: 1 count of input

Resolution: \pm/LSD

Accuracy: same as Resolution

Totalize A - B

Range: -1000 megabits to 1000 megabits

Display: continuous update for input repetition rates up to 5 MHz; beyond 5 MHz, display is updated when measurement is completed.

LSD: 1 count of input

Resolution: \pm/LSD

Accuracy: same as Resolution

Auto-Parameters

Repetition rate: 15 Hz to 20 MHz, such that period - time parameter > 35 ns.

Note: time parameter is parameter being measured except the time parameter for duty cycle is pulse width, and time parameter for phase shift is propagation delay.

Maximum input undershoot + overshoot: 10%

Minimum peak-to-peak amplitude: 3 divisions and 35 mV

Resolution: $\pm/\text{LSD} \pm/\text{start trigger error}/\sqrt{(\# \text{ of averages})}$
 $\pm/\text{stop trigger error}/\sqrt{(\# \text{ of averages})}$

Time parameter accuracy: $\pm/\text{resolution} \pm/(\text{time base error} \times \text{time interval}) \pm/\text{auto trigger error} \pm/\text{systematic error}$

Note: systematic error for rise time, fall time, pulse width, and duty cycle is 1 ns. Systematic error for propagation delay and phase shift is 2 ns.

Auto-trigger error: $\pm/\frac{1\% \text{ of input p-p voltage}}{\text{slew rate at start trigger point}}$

$\pm/\frac{1\% \text{ of input p-p voltage}}{\text{slew rate at stop trigger point}}$

Time Base

Standard high stability, temperature-compensated crystal oscillator.

Frequency: 10 MHz

Aging rate: <1 part in 10E7 per month

Short term: <1 part in 10E9 rms for one-second average; <2 parts in 10E6, 0°C to 55°C

External time base input: front panel BNC accepts 10 MHz 1 V rms to 10 V rms into 50 Ω. Time base selected to external via soft key selection.

Triggering

Minimum $\pm/\text{pulse widths}$: main = 5.0 ns (100 MHz maximum); delayed = 6.25 ns (80 MHz maximum)

Definitions

Systematic error: timing error due to propagation delays between start(A) and stop(B) trigger paths.

Common source (main-to-main or delayed-to-delayed): 500 ps

Dual source with equal vertical sensitivities: 1 ns

Dual source with unequal vertical sensitivities: 2 ns.



19860A Digital Waveform Storage Specifications

Vertical

Analog bandwidth: dc to 100 MHz; ac coupled lower limit is <10 Hz; 3 dB down from a 5 div reference; 0° to 40°C.

Acquisition window: $\geq \pm 4.5$ div from center horiz graticule line.

Matching of data to CRT graticule lines:¹ $\pm 2\%$ of full scale.

Matching of Digitized to Real Time Traces¹

Sine Wave, Percent of Full-Scale		
10 Hz	1 kHz	1 MHz
$\pm 1.5\%$	$\pm 1.5\%$	$\pm 2.5\%$

Excludes first data point. In repetitive mode, trigger rep rate must be 1 Hz or faster. In single sweep mode, trigger must occur within 1 s of digitize command, otherwise exclude first five data points. Data for this specification is acquired using the Auto-Cal default mode of a full Auto-Cal.

Absolute accuracy of data: \pm (accuracy of vertical channel + matching of digitized trace to real-time trace + matching of data to graticule line).

DC offset: <0.2 div from real-time trace at time of data acquisition.
¹Full scale is ten divisions.

RMS Noise²

Waveform Storage Mode	2 mV/div to 9.99 mV/div	10 mV/div to 10 V/div
Normal	0.75%	0.5%
8 Averages or Filtered	0.4%	0.25%

²Measured by grounding the vertical input, digitizing, and calculating the RMS value of the data.

Horizontal

Acquisition window: main horizontal display mode (main s/div x 10 div); in intensified and delayed (delayed s/div x 10 div). In intensified and delayed, the acquisition window can be delayed 0 to 9.9999 s from main trigger point.

Time offset from real-time trace: $-(\leq 30 \text{ ns})$.

Timing accuracy: $\pm (2 \text{ ns} + 0.2\% \text{ of the acquired time window})$.

Jitter: 0.002% of delay time + 1 ns; at 10 MHz $\pm 10 \text{ kHz}$, 0.01% of delay time + 1 ns.

Operating Characteristics

Repeatability of data: approx 2% for waveforms acquired within 8 hours and within 20°C to 30°C. To optimize repeatability of waveform data, use either a minimum of 8 averages or filtered mode, for signals <100 Hz use dc or 50 Ω dc input coupling.

Vertical resolution: 10 bits, approx 0.1% of full scale.

Auto-Cal: pre-acquisition calibration of sampling efficiency that also sets offset and gain data correction factors. Offset and gain factors are used for post-acquisition data correction to match a digitized trace to a real time trace.

Sample density: selectable 1, 3, 6, 11, 21, 51, 101, 251, 501 points at any sweep speed.

Minimum time between points: repetitive, 100 ps, clocked by 1980 delay generator; single-shot, 19.8 μs , clocked by 1980 processor clock.

Acquisition mode: repetitive, 999 $\mu\text{s}/\text{div}$ to 5 ns/div, two sweeps per point; single-shot, 1 s/div to 1 ms/div, one sweep per waveform.

Averaging: each sample point may be averaged 2, 4, 8, 16, 32, or 64 times in repetitive mode to reduce noise; $N + 1$ sweeps required per point, where N = number of averages.

Filter: approx 1 MHz low pass filter selectable in single-shot.

Cursors: start and stop cursors for memories (M1 and M2) to measure voltage from center graticule line, time from main trigger point, or ΔV and ΔT measurements on stored waveforms.

General

Operating environment: same as 1980B.

Weight: net, 0.4 kg (13 oz). Shipping, 0.9 kg (2 lb).

19800A/B, 19801A/B/C Product Description

Series 1980 Application Software is available for Series 80 computers (19801A/B/C) and Series 200 computers (19800A/B). Application software is available for the Series 1000 computers through the HP Plus program; contact your local HP Sales Office for more details.

Measurement Programs

Automatic waveform measurement program: automatically characterizes many different kinds of waveforms, displays measurement results, and can plot waveforms for permanent records. This program uses Trigger Flag and the 19860A Digital Waveform Storage.

User-interactive waveform measurement program (19800 only): provides interactive menus allowing you to characterize waveform parameters, control waveform data bases, and obtain hardcopy output of results or waveforms. Measurements include pulse parameters and two-channel time intervals. This program uses Trigger Flag and the 19860A Digital Waveform Storage.

Universal counter measurement program (19800 only): automatically characterizes waveform parameters using the 1965A. Trigger levels for rise time, fall time, and pulse width measurements are determined by digitally storing trigger view and determining top and base using a histogram.

Gated time interval measurement program (19800 only): leads user through the process of making a gated time interval measurement with the 1965A. Measurement setups can be saved and recalled at a later time.

Library Subprograms

1. The waveform characterization subprograms perform a wide range of parametric time-domain measurements by using the data captured by both the 19860A and Trigger Flag.

2. The waveform comparison subprograms perform limit test on waveform parameters to determine whether a given waveform is acceptable according to a specified set of tolerances.

3. The waveform setup subprograms reduce test times and eliminate operator setup errors by automatically setting up the 1980A/B. Within this group is a subprogram that automatically rescales the waveform if there is insufficient information within the waveform data for the measurement.

4. The waveform data management subprograms control the 19860A and direct the movement of waveform data records. With these subprograms, permanent records of key waveforms can be made. Accessing these records eliminates needless repetition and simplifies the documentation of procedures and results.

5. The general utilities subprograms simplify the development of application programs. For example, they initialize the system, help debug programs being developed, manage instrument setup data, output results and plot waveforms onto HP graphics printers and plotters.

6. The 1965A subprograms set up and control the counter functions. They also perform statistical analysis on measurement results.

Ordering Information

1980S Oscilloscope Measurement System

Use the system model number when ordering a system mainframe with expansion modules, enhancements, and computer products. Any model number can also be ordered individually. Using the system model ensures coordination of shipments and compatibility of instruments, computers, and software

1980A Oscilloscope Measurement System (cabinet)

1980B Oscilloscope Measurement System (rack)

1950A 100 MHz Two-channel Expansion Module

1965A 100 MHz Gated Universal Counter

19811A Plot/Sequence ROM

19860A Digital Waveform Storage

19800A/B Waveform Measurement Library

19801A/B/C Waveform Measurement Library

1980A/B+24A Waveform Measurement System

Training

19807A Service Extender for expansion modules

OSCILLOSCOPES

100 MHz General Purpose, Large-Screen

Models 1740A, 1742A, 1745A, 1746A

- Laboratory-quality viewing plus portability
- Optional built-in DMM for increased accuracy & flexibility
- Dual channel, 5 mV/div to 100 MHz
- 3rd channel trigger view and selectable input impedance

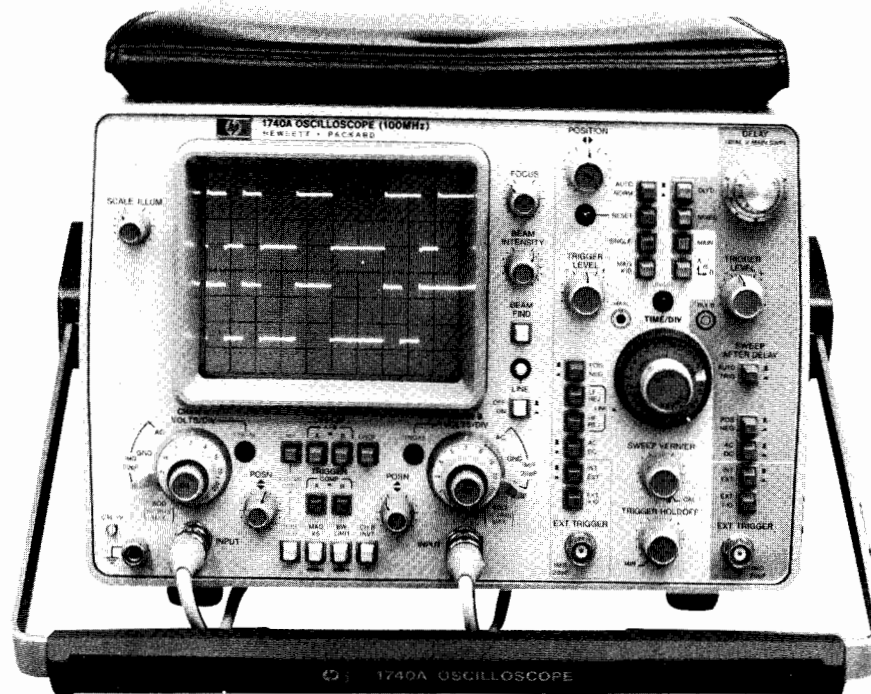

Description

The 1740 series of 100 MHz, dual-channel oscilloscopes have proven to be highly reliable measurement tools by passing the most complete testing program possible—years of use by satisfied customers. This reliable performance coupled with versatile measurement sets offer exceptional value for your time interval and general purpose oscilloscope needs over the long term.

The 1740s provide several measurement features that users have found to be particularly valuable. Both vertical channels provide 1 mV/div deflection factors with dc to 40 MHz bandwidth performance; the full 100 MHz performance is achieved with deflection factors of 5 mV/div to 20 V/div. Third channel trigger view, first offered in the 1740A, permits viewing the trigger signal plus simultaneous viewing and timing of the external trigger signal with both vertical channels. A X10 horizontal magnifier provides main and delayed sweep speeds to 5 ns/div, allowing full use of the 100 MHz bandwidth amplifiers. These amplifiers have a Gaussian roll-off characteristic for accurate pulse response.

In addition, the 1740s offer a TV/video sync option that allows a variety of measurements to be made on complex video waveforms. There is also an optional auto-ranging DMM with 3½ digit resolution for ac/dc voltage, ac/dc current, and resistance measurements.

Individual Characteristics

1740A/1742A

The 1740A, which is the basic building block of the 1740 series, is a highly reliable general purpose 100 MHz oscilloscope. In addition to the family characteristics of the 1740 series, the 1740A uses a single-marker delayed sweep for time interval measurements.

The 1740A's front panel is laid out in a clear logical manner and has a color coding scheme that simplifies operation. The blue buttons control the display functions, while all trigger function buttons are green. Other controls are light gray or white, and the delayed sweep functions are highlighted with a shaded background.

To the oscilloscope user, the most critical component in the instrument is the cathode ray tube (CRT). The 8 × 10 cm CRT used in the 1740A has been perfected to the point where it has been described as

having "the brightest, crispest trace in the industry." Since the CRT is also the most expensive part of an oscilloscope, it is imperative that it be extremely reliable. With the 1740A, HP's CRT improvements have led to less than 1.4 failures per year per 1000 instruments — believed to be the best reliability record of any comparable CRT in industry.

The 1742A incorporates HP's dual-marker, time interval measurement system. When the optional autoranging DMM is added to the 1742A, it provides a direct readout of time interval measurements. The 1742A has the same front panel as the 1740A, except that the 1742A replaces the 1740A's delay control with several time interval controls.

1745A/1746A

Both the HP model 1745A and 1746A oscilloscopes add a large screen CRT and a revised front panel to the time-tested instrument design of the 1740A. The new CRT offers a 43% larger viewing area while maintaining the same high standards of the 1740A trace quality. This provides more resolution for more accurate measurements, especially with multi-channel measurements that use third channel trigger view.

Voltage measurements are also simplified. The CRT graticule is 10 x 10 divisions instead of the more traditional 8 x 10 divisions. Full-scale voltage display is ten times the deflection factor - greatly reducing the amount of mental arithmetic required of the user.

The 1745A and 1746A both offer a neutral gray contrast screen which is heat-treated with a proprietary antireflection coating. You obtain bright, sharp trace definition without annoying light reflections. In keeping with the new CRT's contrast screen color, the color coding of the controls has also been changed. The dark buttons control the display functions while all trigger functions are medium gray. Miscellaneous functions are light gray and all delayed sweep functions are highlighted with a lightly shaded background.

The 1745A uses the familiar single-marker delayed sweep to perform time interval measurements. The 1746A adds HP's dual-marker

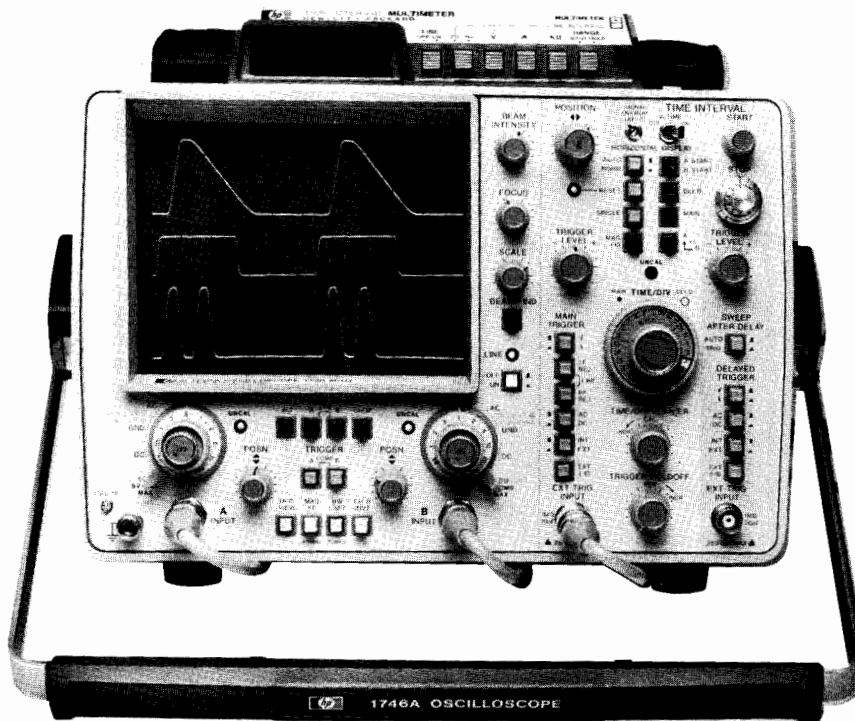

With a CRT screen 43% larger than the industry standard, the 1746A 100 MHz, time interval oscilloscope provides laboratory quality viewing in a portable package.

delta time measurement capability for faster and more accurate timing measurements. When combined with the optional DMM, a direct readout of time interval measurements is provided on the LED display.

Family Characteristics

Third Channel Trigger View

In many measurements, especially in digital applications, it is desirable to trigger the main sweep externally using a signal synchronous with the displayed waveforms. The third channel trigger view offers several measurement conveniences in timing applications:

- 1) The trigger threshold can be viewed relative to the trigger waveform for either an internal or external trigger source. Trigger threshold is the center horizontal graticule line and the trigger point is selected by positioning the trigger waveform vertically on the reference graticule line using the Main Sweep Trigger Level control. This also allows you to view the shape of the trigger waveform to verify that the correct signal is used as the trigger source and that the trigger threshold is not set to portions of a waveform containing irregularities and reflections.
- 2) With trigger view, three channels of information are displayed so that timing relationships can be analyzed. The displayed trigger signal has a specified delay of < 3.5 ns relative to the two vertical channels.

Serviceability

Innovations in circuit design along with custom integrated hybrid circuits reduce calibration time because of a minimum of adjustments. Wire harnesses and interconnection cables between boards are reduced with an interface board which connects the main boards together. This interface board helps to reduce service time and reassembly errors normally encountered with instruments containing many cables. These oscilloscopes do not require a fan or ventilating holes for convection cooling, reducing the amount of dust and dirt that can accumulate internally.

Optional Measurement Capability

TV Sync Option

With this option you can trigger on composite video for analyzing fields, test signals, timing relationships, lines, or segments of lines. This capability is provided through a TV sync separator circuit that triggers the main sweep on the vertical interval of a composite video waveform and triggers the delayed sweep on individual horizontal lines.

Video Waveform Display

To aid in viewing specific portions of composite video waveforms, the TV sync option includes field select, TV line scan, and single line scan capabilities. Field selection is easily accomplished by pressing the field select button that automatically displays the alternate field in the frame. The TV line scan control allows you to position the intensified marker to the desired location for expansion. When switched to delayed sweep, individual lines are easily inspected and measured. For precise control of highly expanded line segments, single line scan lets you examine one line in detail.

The TV/Video Sync option is installed on the top cover and provides its own signal input with a 75 Ω termination to match most video systems. The input also provides a TV clamp that combines ac coupling and negative clamping to eliminate position shift due to varying levels for video information.

Optional Digital Multimeter

Adding an optional 3½ digit autoranging DMM improves the convenience of your basic measurement capabilities. With the optional DMM, you can make the five most common measurements: ac and dc voltage, ac and dc current, and resistance. The DMM has autoranging so that readings always have the same multiplier: voltage in volts, current in amperes, and resistance in kilohms.

In the 1746A, the optional DMM improves the accuracy and convenience of delta time measurements. A switch on the 1746A lets you select DMM operation or direct delta time readout.



OSCILLOSCOPES

Precision Time Interval, 275 MHz, 100 MHz

Models 1726A, 1743A

- Time interval averaging to ± 50 ps (1726A)
- First pulse measurements

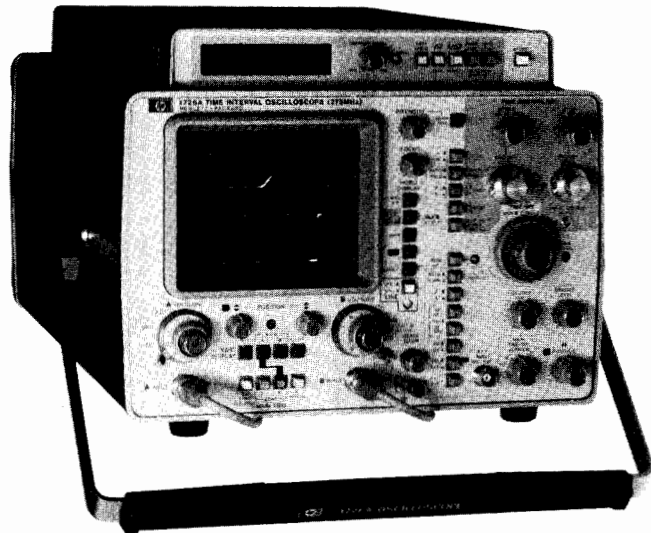

Precision Time Interval Oscilloscopes

The 1726A (275 MHz) and the 1743A (100 MHz) both provide precise time interval measurements by using a time interval averaging technique. In both the 1726A and the 1743A, HP has eliminated the traditional oscilloscope horizontal sweep ramp as a reference for timing measurements and replaced it with a technique that measures time intervals by accumulating counts from a crystal oscillator. This allows these oscilloscopes to measure time intervals relative to the trigger event that synchronizes its waveform display, allowing them to make first pulse measurements. First pulse measurements are a class of measurements that are absolutely needed when solving many timing problems in today's fast circuits.

In addition to first pulse measurements, the crystal-referenced time base permits accurate timing measurements to be made with the oscilloscope's horizontal sweep vernier out of calibration. This extends the useful measurement range of every time base setting by a factor of three. This is important because accuracy is partially determined by the Main Time/Div setting. For example, the 1726A can measure time intervals as long as 1.2 μ s with ± 10 ps resolution.

The 1726A—On the Leading Edge of Technology

The high bandwidth (275 MHz) of the 1726A enables it to make the stringent timing measurements that have resulted from advances in IC design, device characterization of custom ICs (e.g., bipolar and MOS processes), ECL circuits, and faster clock speeds in computers and other electronic systems. For example, characterizing a process, verifying system operation, or troubleshooting a new design all require the highly accurate and repeatable measurements that the 1726A can make.

Fast, Confident Measurements

Combining a CRT with a marker system makes the measured interval easy to identify. Matched wideband pre-amplifiers allow pulse parameters such as overshoot and ringing to be examined, and the overlap mode permits precise measurements to be made from specific points on any displayed waveform. This measurement system eliminates uncertainty concerning the exact interval being measured, and it obsoletes the technique of externally gating a time interval counter with an oscilloscope.

Precise Measurements (± 50 ps)

Time interval averaging, which is automatically controlled through the Main Time/Div switch, allows the 1726A to make precise measurements on virtually any repetitive signal that can be displayed on

- HP-IB data output (1726A)
- Complete time interval solution

an oscilloscope. A crystal-referenced time base combines with sophisticated triggering circuits to form the most accurate measurement system available today—up to 10 ps resolution and 50 ps accuracy.

Repeatability and Convenience

Complex time interval measurements are highly repeatable and easy to make with the 1726A's triggered mode of operation. The triggered mode minimizes setup time, simplifies measurement procedures, and it allows highly repeatable measurements independent of the operator's skill level. The fast mode, which reduces the number of averages taken by a factor of ten, minimizes measurement time in all operating modes. In production and record-keeping applications, the 1726A's HP-IB interface outputs time interval information.

Operating Modes

The 1726A offers two modes of time interval operation, the overlap mode and the triggered mode, in which time interval averaging is used to make accurate measurements. The 1726A has a large LED read-out on its time interval module that displays answers and other relevant timing information.

Overlap Mode

The overlap mode is designed for applications that require absolute accuracy. In this mode, the CRT is used as a visual comparator for making timing measurements. This powerful technique is possible because of the known relationships between the delayed display and the stopping point for the counting process utilized in a time interval measurement.

Three steps are required to make a measurement. First, select ΔT and position the start/stop intensified markers on the desired edges. Next, switch to ΔT Overlap (i.e., delayed display). Increase screen resolution with Mag $\times 10$, and overlap or align the start/stop waveforms precisely. The answer is automatically displayed on the LED or output through the HP-IB interface.

Triggered Mode

The 1726A's triggered mode provides simplicity and repeatability. With this mode, multiple timing measurements can be made quickly and confidently, virtually free of operator error. After triggered mode has been selected, only two steps are required to perform a measurement. First, adjust the start/stop trigger levels using the LED display

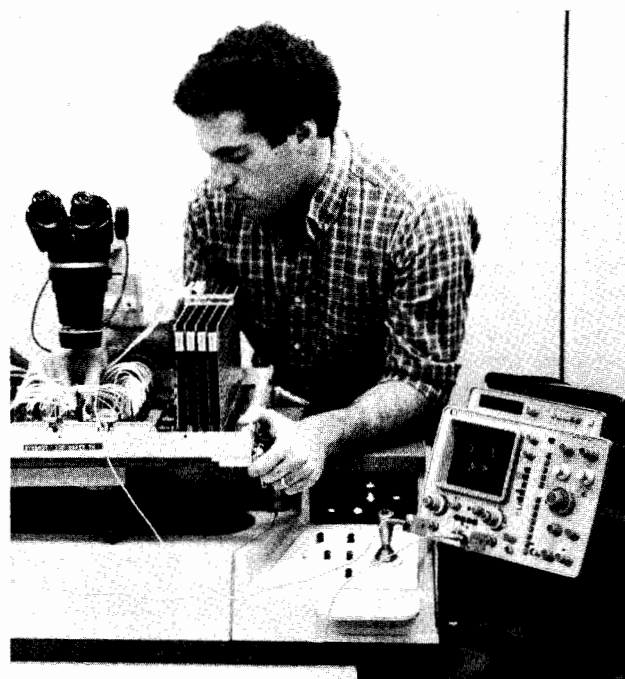

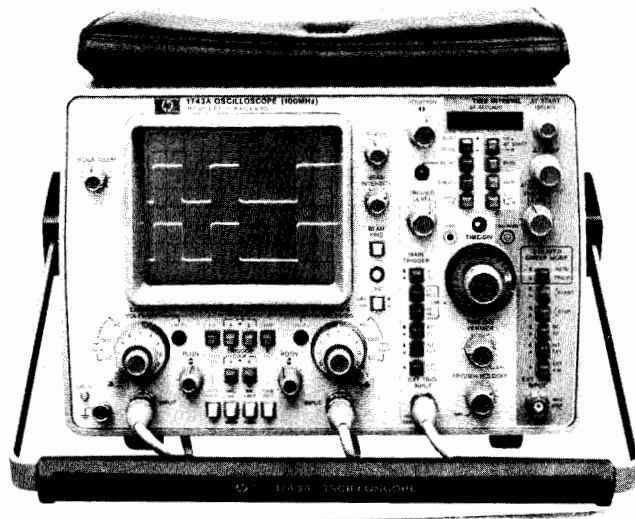
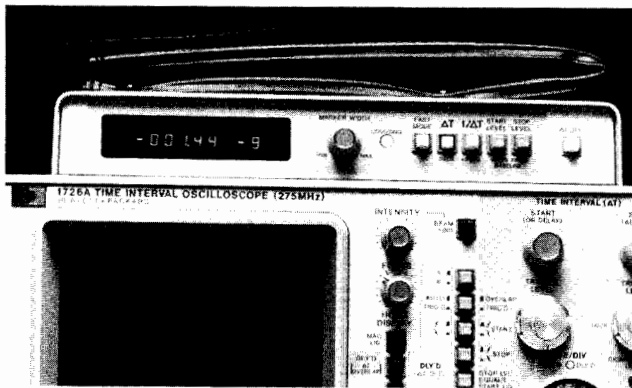

as a trigger voltage readout. Then, position the intensified markers on the desired edges with the start/stop and slope controls and press ΔT . Measurements are made from the trigger point of the start intensified marker to the trigger point of the stop intensified marker.

Measurements can be repeated days apart, and answers for a given signal and start/stop trigger level are repeatable to within ± 30 ps. Repeatability is an operating characteristic based on characterization data. Absolute accuracy can be verified with the overlap mode because several variables affect the accuracy of the triggered mode.

Match Probe/Cable Propagation Delays

In many two-channel applications, small (± 200 ps) differences in probe or cable propagation delays can significantly affect short time interval measurements. A front panel adjustment, Signal Overlap $A=B$, is designed to compensate for small (± 0.5 ns) differential delays between probes or cables.

Fast Mode

This front panel button reduces the number of averages required for a measurement by a factor of ten. It is primarily a convenience for quickly updating the time interval display. However, in low repetition rate applications, this mode is extremely useful. Reducing the number of averages affects the displayed resolution and/or the uncertainty in the least significant digit.

Data Output Capability

A standard HP-IB interface on the 1726A can output data for production and record-keeping applications. Time interval measurements are easily output over HP-IB; and in the triggered mode, the start/stop trigger levels can be obtained.

The Complete Time Interval Solution

Completing HP's time interval measurement solution is the HP 10326A Time Interval Standard, a dual-channel signal source. The 10326A's waveform period accuracy (± 5 ps) and specified dual-channel timing relationships provide convenient signals with which to evaluate system performance and subsystem design. The 10326A is exceptionally easy to maintain, and its calibration procedure is completely traceable to the United States National Bureau of Standards and to the calibration facilities of other International Standards Organization members.

1743A Description

The 1743A adds to the feature set of the 1740A a delta time system based on a 100 MHz crystal oscillator rather than the traditional analog reference ramp. A time interval averaging technique increases both the accuracy and resolution of repetitive waveform measurements. This technique measures the time interval by accumulating counts from the 100 MHz crystal oscillator with a fundamental accuracy of ± 1 clock period (± 10 ns from a 100 MHz clock). However, by using a time interval averaging technique, the resolution of the measurement is increased by N , where N is the number of averages. At the three fastest sweep speeds, 10,000 intervals are averaged to produce a measurement with a 100 ps resolution. The averaged time interval measurement is directly displayed on a five-digit LED readout.

Time interval measurements relative to the leading edge of the first pulse in the main sweep display can be made with the 1743A. This first pulse measurement capability permits measurements between the trigger signal and the other two channels. In the trigger view mode, the start marker is on the trigger channel with the stop marker on each of the two channels at the same point in time. This allows timing measurements from the leading edge of an asynchronous signal, such as a strobe or flag, to resulting activity on Channels A and B.

The triggered delay mode of the 1743A offers excellent pulse width, period, and propagation delay measurement capability. The triggered delta sweep mode automatically performs the desired measurements without any of the complex operations usually needed with delayed sweep measurements. By selecting the appropriate start and stop slopes (one positive and one negative for width measurements and both the same for period measurements) you can conveniently read out the period or width measurement while directly viewing the exact trigger level at which the measurement is being made.

Also available is the ability to make duty cycle measurements quickly. In the intensified mode, measure the pulse width and period with the direct LED readout. Then, a simple ratio calculation provides an accurate answer.

Ordering Information

1726A Time Interval Oscilloscope (275 MHz)

1743A 100 MHz Oscilloscope

OSCILLOSCOPES

100 MHz Variable Persistence/Storage

Model 1741A

- 200 cm/ μ s variable persistence and stored writing rate
- Minimum blind time, auto-intensity circuit
- Dual channel, 5 mV/div to 100 MHz
- 3rd channel trigger view and selectable input impedance

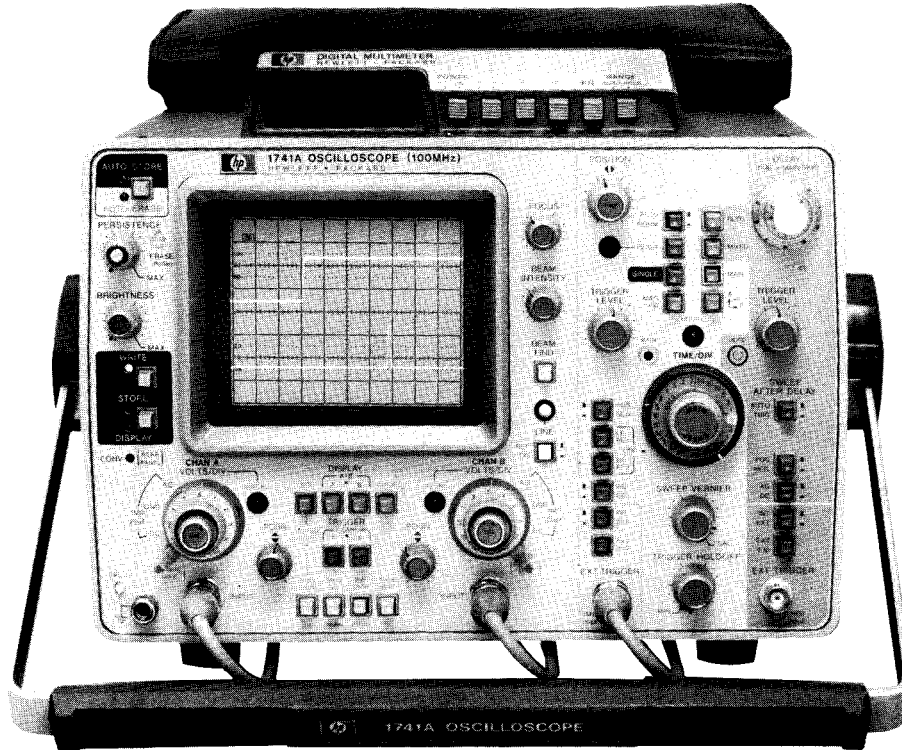

1741A opt 034

1741A Description

The HP 1741A provides a "one oscilloscope" solution to the wide variety of measurements encountered daily. The versatility results from the many operating modes available; from minimum persistence, which approximates conventional operation, to continuous persistence settings and automatic storage. The adjustable persistence control provides the ability to match signal and persistence characteristics resulting in excellent display characteristics over a wide range of conditions.

The 1741A provides a clear display of virtually any signal. However, it is especially useful in certain applications. Low repetition rate signals at fast sweep speeds produce very low light output on conventional CRTs and normally require the use of a viewing hood to obtain a viewable display. The variable persistence mode solves this problem by integrating several sweeps to amplify the light output, producing bright, clear traces. This "light-integrating" capability is also useful in eliminating flickering displays, which are the result of low repetition rates and slow sweep speed signals. These signals are annoying to view and even more difficult to measure; however, the display is improved by matching signal and persistence characteristics.

Single-shot events are also captured easily using the auto-store mode. Once set, it waits and captures a sweep after the first trigger event. During operation of the oscilloscope, any display on the CRT can be saved at the touch of a button, no matter what mode the instrument is in.

Writing Speed and Blind Time

In all Hewlett-Packard storage oscilloscopes, the advanced technology used allows signals to be captured at the maximum writing speed in both variable persistence and single-shot modes (1741A—200 cm/ μ s; 1744A—1800 cm/ μ s; 1727A—2000 cm/ μ s). These fast writing speeds are achieved without reduced scans or excessive blind times.

1741A Auto-Camera Option

The Auto-Camera Option 003 combines with the 1741A to obtain photographic records, especially in long-term monitoring applications

where hours of "babysitting" time can be saved. Setup involves mounting a 197B camera on the 1741A and selecting the auto-store mode.

Optional Parametric Measurements

A new dimension of measurement capability is added to the 1741A with option 002, triggered A vs. B mode. Many non-time related displays commonly encountered in engineering problems, such as the Lissajous pattern, are clearly and accurately displayed. Option 002 adds a variable delay line in the horizontal axis, eliminating phase error and enabling the 1741A to produce matched phase response up to the 5 MHz bandwidth of the horizontal section. This triggered technique eliminates the bright spots caused by inactivity in the A vs. B mode and removes any confusion created by having unnecessary information on the display.

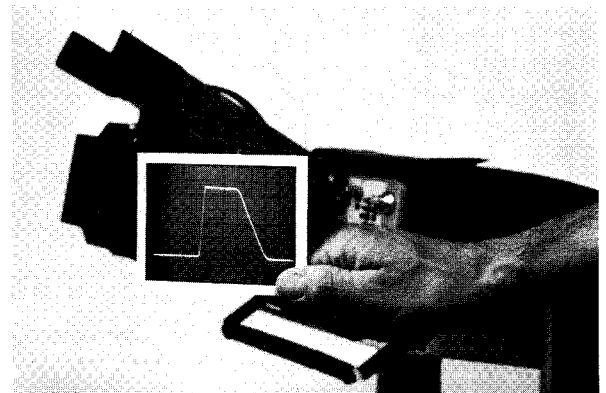

Long term monitoring of circuits to capture random events is simplified with the 1741A Auto-camera Option 003. You can set up the oscilloscope/camera, leave them unattended, and automatically capture single-shot events.



- 1800 cm/ μ s variable persistence and stored writing rate
- Minimum blind time, auto-intensity circuit

- Dual channel 5 mV/div to 100 MHz
- 3rd channel trigger view and selectable input impedance

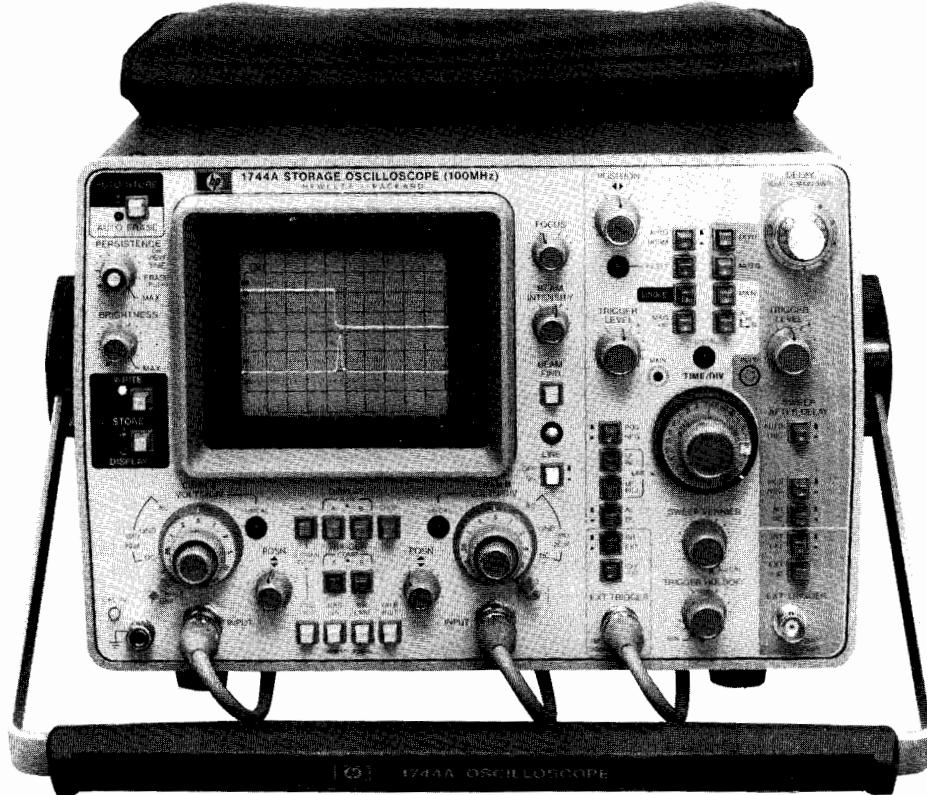

1744A

Expansion Storage 1744A (1800 cm/ μ s)

The ability to capture signals at the maximum bandwidth of the 1744A vertical deflection system is achieved with expansion storage CRT technology. This fast writing speed is achieved by combining a miniature precision storage mesh with an electronic lens system that magnifies and projects the stored image. The extremely fast writing speeds provided by the expansion mesh technology are available in both variable persistence and storage modes. Operation is enhanced with an automatic focus circuit and maintains a crisp display with changes in intensity while an auto-intensity circuit helps to maintain a constant beam current to the storage surface over a wide range of sweep speeds.

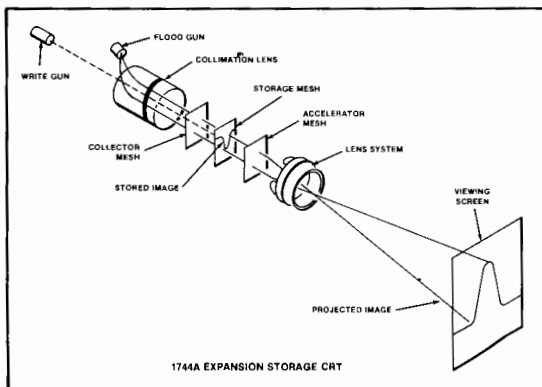

Expansion Storage CRT

1741A, 1744A 1727A Operation

An auto-intensity circuit in all of these variable persistence/storage oscilloscopes simplifies operation. This circuit permits sharp, flicker-free, non-blooming traces to be obtained in the variable persistence mode under almost all operating conditions. There is a variety of settings available in the variable persistence mode. However, there is an easily set reference position that will provide a viewable trace: intensity—max, persistence—min, brightness—min. From this position, intensity can be decreased and persistence can be increased as necessary.

In addition to the variable persistence mode, storage LEDs provide positive identification of storage operating modes. The auto-erase mode periodically takes individual “snapshots” of an input signal. In this mode, persistence is internally set to maximum and the persistence control regulates how frequently a new “snapshot” is captured and displayed.

The auto-store mode makes single-shot events easy to capture and reduces the possibility of recording the wrong event by automatically switching to the normal trigger mode. The oscilloscope automatically switches from a “write” mode to a “store” mode after the sweep of the single-shot event for maximum trace retention time. A “store” LED indicates that the event is captured and one press of the Store/Display button displays the stored trace.

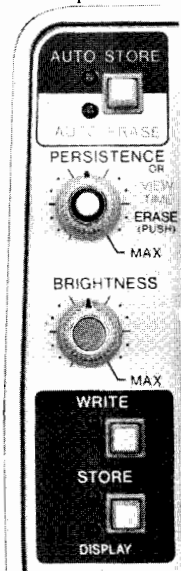

OSCILLOSCOPES

100 HMz Specifications

Models 1740A, 1741A, 1742A, 1743A, 1744A, 1745A, 1746A

Specifications

Vertical Display Modes

Channel A; channel B; A and B displayed alternately on successive sweeps (ALT); A and B displayed by switching between channels at ≈ 250 kHz rate with blanking during switching (CHOP); A plus B (algebraic addition); and trigger view.

Vertical Amplifiers (2) Bandwidth and rise time at all deflection factors from 0°C to $+55^\circ\text{C}$.

Bandwidth: 3 dB down from 8 div reference signal; 3 dB down from 6 div reference signal for 1741A, 1744A; 3 dB down from 10 div reference signal for 1745A, 1746A.

DC-coupled: dc to 100 MHz in both 50 Ω and 1 M Ω input modes.

AC-coupled: ≈ 10 Hz to 100 MHz.

Bandwidth limit: limits upper bandwidth to ≈ 20 MHz.

Rise time: ≤ 3.5 ns measured from 10% to 90% points of a 6 div (5 div, 1744A, 1745A, 1746A) input step.

Deflection Factor

Ranges: 5 mV/div to 20 V/div (12 calibrated positions) in 1, 2, 5 sequence, attenuator accuracy $\pm 3\%$.

Vernier: extends deflection factor to ≥ 50 V/div.

Polarity: channel B may be inverted.

Input coupling: selectable ac or dc, 50 Ω (dc), or ground.

Input RC (selectable): ac or dc, 1 M Ω $\pm 2\%$ shunted by ≈ 20 pF; 50 Ω , 50 Ω $\pm 3\%$, SWR ≤ 1.4 at 100 MHz.

Maximum input: ac or dc, 250 V (dc + peak ac) or 500 V p-p at ≤ 1 kHz; 50 Ω , 5 V rms.

A + B Operation

Amplifier: bandwidth and deflection factors are unchanged; channel B may be inverted for A-B operation.

Differential (A-B) common mode: CMR is at least 20 dB from dc to 20 MHz. Common mode signal amplitude equivalent to 8 div (6 div, 1744A; 10 div for 1745A, 1746A) with one vernier adjusted for optimum rejection.

Vertical Magnification (X5)

Bandwidth: 3 dB down from 8 div (6 div, 1744A; 10 div for 1745A, 1746A) reference signal.

DC-coupled: dc to ≈ 40 MHz; dc to ≈ 30 MHz for 1741A, 1744A.

AC-coupled: ≈ 10 Hz to 40 MHz; ≈ 10 Hz to 30 MHz for 1741A, 1744A.

Rise time: ≤ 9 ns, ≤ 12 ns for 1741A, 1744A (measured from 10% to 90% points of 8 div, 5 div 1744A, 1745, 1746A input step).

Deflection factor: increases sensitivity of 5 and 10 mV settings by a factor of 5 with max sensitivity of 1 mV on channels A and B.

Trigger Source

Selectable from channel A, channel B, composite, or line frequency.

Trigger View

Displays internal or external trigger signal. In Alternate or Chop mode, channel A, channel B, and the trigger signals are displayed. In channel A or B mode, trigger view overrides that channel. Internal trigger signal amplitude approximates vertical signal amplitude. EXT trigger signal deflection factor is 100 mV/div or 1 V/div in EXT $\div 10$. Triggering point is approx center screen. With identically timed signals to a vertical input and the EXT trigger input, trigger signal delay is ≤ 3.5 ns.

Horizontal Display Modes

Main, Δ time with channel A or B start (1746A, 1743A), main intensified, mixed (except 1743A, 1746A), delayed, mag X10, and A vs. B.

Main and Delayed Time Bases

Ranges

Main: 50 ns/div to 2 s/div (24 ranges) in 1, 2, 5 sequence.

Delayed: 50 ns/div to 20 ms/div (18 ranges) in 1, 2, 5 sequence.

Accuracy

Sweep Time/div	*Accuracy		Temp Range
	X1	X10	
50 ns to 20 ms	$\pm 3\%$	$\pm 4\%$	0°C to $+15^\circ\text{C}$
	$\pm 2\%$	$\pm 3\%$	$+15^\circ\text{C}$ to $+35^\circ\text{C}$
	$\pm 3\%$	$\pm 4\%$	$+35^\circ\text{C}$ to $+55^\circ\text{C}$

*Add 1% for 50 ms to 2 s ranges

Main sweep vernier: extends slowest sweep to at least 5 s/div.

Magnifier (X10): extends fastest sweep to 5 ns/div.

Calibrated Sweep Delay (except 1743A)

Delay time range: 0.5 to 10X Main Time/div settings of 100 ns to 2 s (min delay 150 ns).

Differential Time Measurement Accuracy

(using one intensified marker and helical control)

Main Time Base Setting	Accuracy* ($+15^\circ\text{C}$ to $+35^\circ\text{C}$)
100 ns/div to 20 ms/div	$\pm (0.5\%$ of reading $+0.1\%$ of fs)
50 ms/div to 2 s/div	$\pm (1\%$ of reading $+0.1\%$ of fs)

*Add 1% for temperature from 0°C to $+15^\circ\text{C}$ and $+35^\circ\text{C}$ to $+55^\circ\text{C}$.

Delay jitter: $<0.002\%$ (1 part in 50 000) of max delay in each step from $+15^\circ\text{C}$ to $+35^\circ\text{C}$; $<0.005\%$ (1 part in 20 000) from 0°C to $+15^\circ\text{C}$ and $+35^\circ\text{C}$ to $+50^\circ\text{C}$.

Differential Time Measurement Accuracy (1742A/1746A)

(using Δ time dual intensified markers)

Main Time Base Setting	Accuracy* ($+15^\circ\text{C}$ to $+35^\circ\text{C}$)		
	Opt 034/035	External DVM***	Helical
100 ns** to 20 ms/div	$\pm (0.5\%$ of reading $+0.05\%$ of fs)	$\pm (0.5\%$ of reading $+0.05\%$ of fs)	$\pm (0.5\%$ of reading $+0.1\%$ of fs)
50 ms to 2 s/div	$\pm (1\%$ of reading $+0.1\%$ of fs)	$\pm (1\%$ of reading $+0.1\%$ of fs)	$\pm (1\%$ of reading $+0.1\%$ of fs)

*Add 1% for temperature from 0°C to $+15^\circ\text{C}$ and $+35^\circ\text{C}$ to $+55^\circ\text{C}$.

**On 100 ns/div range, specification applies after first cm of main sweep.

***Add DVM accuracy.

Time Interval (Δ Time) 1742A, 1746A

Function: measures time interval between two events on channel A (A display); two events on channel B (B display); or two events starting from an event on either channel A or B and ending with an event on either channel A or B (alternate display).

Time interval output voltage: varies from 50 V to 100 mV full scale. Full scale output voltage can be determined by multiplying the number on the Time/Div dial by 10 V (e.g., 0.05 s, 0.05 ms, or 0.05 μs per div gives 0.5 V output full-scale).

Stability (0°C to $+55^\circ\text{C}$): short-term 0.005%. Temperature, $\pm 0.03\%/^\circ\text{C}$ deviation from calibration temperature range.

Crystal Referenced Δ Time (1743A)

Delay time range: 0 to 10 X main time/div settings of 100 ns to 2 s.

Differential Time Measurement Accuracy

Accuracy: $\pm 0.002\%$ of reading ± 1 count from $+15^\circ\text{C}$ to $+35^\circ\text{C}$; $\pm 0.005\%$ of reading ± 1 count from 0°C to $+15^\circ\text{C}$ and $+35^\circ\text{C}$ to $+55^\circ\text{C}$.

Time Resolution of ± 1 Count

Sweep Ranges/div	± 1 Count	Averages
0.1 μs , 0.2 μs , 0.5 μs	± 100 ps	10 000
1 μs , 2 μs , 5 μs	± 1 ns	1 000
10 μs , 20 μs , 50 μs	± 10 ns	100
0.1 ms, 0.2 ms, 0.5 ms	± 100 ns	direct

Readout: 5 digit LED plus exponent.

Crystal aging: 0.0005% per year.

Delay jitter: same as other 1740-series oscilloscopes.

Triggering

Main Sweep

Normal: sweep is triggered by internal or external signal.

Automatic: baseline displayed in absence of input signal. Above ≈ 40 Hz, triggering is same as normal.

Single: sweep occurs once with same triggering as Normal. Reset arms sweep and lights indicator (1741A, 1744A). Single sweep is also initiated with Erase, sweep is armed after the erase cycle.

Internal: dc to 25 MHz on signals ≥ 0.3 div vertical deflection, increasing to 1 div vertical deflection at 100 MHz in all display modes (required signal level is increased by 2 when in Chop mode and by 5 when X5 vertical magnifier is used).

External: dc to 50 MHz on signals of 50 mV p-p or more, increasing to 100 mV p-p at 100 MHz (required signal level is increased by 2 when in Chop mode).

Delayed Sweep (sweep after delay)

Auto: delayed sweep starts at end of delay period.

Trig: delayed sweep armed and triggerable at end of delay period. **Internal:** same as Main Sweep except 1743A is dc to 25 MHz on signals causing 1 div or more vertical deflection, increasing to 2 div of vertical deflection at 100 MHz.

External: same as Main sweep except 1743A is dc to 50 MHz on signals 100 mV p-p increasing to 200 mV p-p at 100 MHz.



External Input RC: $\approx 1\text{ M}\Omega$ shunted by $\approx 20\text{ pF}$; max external input, 250 V (dc + peak ac) or 500 V p-p at $\leq 1\text{ kHz}$.

Level and slope: internal, at any point on positive or negative slope of displayed waveform; external, continuously variable from +1 V to -1 V on either slope of trigger signal, +10 V to -10 V in $\div 10$.

Coupling: ac, dc, LF REJ, or HF REJ.

Trigger holdoff (main sweep): increases sweep holdoff, all ranges.

Calibrated Mixed Time Base (except 1742A, 1743A, 1746A)

Dual time base in which the main time base drives the first portion of sweep and the delayed time base completes the sweep at the faster delayed sweep. Also operates in single sweep mode. Accuracy, add 2% to main time base accuracy.

A vs B Operation

Bandwidth: channel A (Y-axis), same as channel A; channel B (X-axis), dc to 5 MHz.

Deflection factor: 5 mV/div to 20 V/div (12 cal positions) in 1, 2, 5 sequence; phase difference between channels, $< 3^\circ$, dc to 100 kHz (75 kHz, 1743A).

Cathode Ray Tube and Controls (1740A, 1742A, 1743A)

Type: 12.7 cm (5 in.) rectangular CRT, post accelerator, $\approx 15\text{ kV}$ accelerating potential, aluminized P31 phosphor.

Graticule: 8×10 div (1 div = 1 cm) internal nonparallax graticule, 0.2 subdivision markings on major horizontal and vertical axes and markings for transition time measurements. Internal floodgun graticule illumination.

Beam finder: returns trace to CRT screen.

Z-axis input (Intensity modulation): +4 V, $\geq 50\text{ ns}$ wide pulse blanks trace of any intensity, usable to $\leq 10\text{ MHz}$ for normal intensity. Input R, $1\text{ k}\Omega \pm 10\%$. Max input $\pm 20\text{ V}$ (dc + peak ac).

Rear panel controls: astigmatism and trace align.

Cathode Ray Tube and Controls (1745A, 1746A)

Type: Hewlett-Packard, 15.6 cm (6.15 in.) rectangular CRT, post accelerator, approximately 21 kV accelerating potential, aluminized P31 phosphor.

Graticule: 10×10 div; 1 vertical div = 0.95 cm, 1 horizontal div = 1.2 cm; internal nonparallax graticule with 0.2 subdivision markings on major horizontal and vertical axes, markings for rise time measurements. Internal flood gun graticule illumination.

Beam finder: returns trace to CRT regardless of horizontal, vertical, or intensity settings.

Z-axis input (Intensity modulation): +4 V, $> 50\text{ ns}$ width pulse blanks trace of any intensity, usable to $\leq 10\text{ MHz}$ for normal intensity; input R, $1\text{ k}\Omega \pm 10\%$; maximum input $\pm 20\text{ V}$ (dc + peak ac), $\leq 1\text{ kHz}$.

Rear panel controls: astigmatism and trace align.

Cathode Ray Tube and Controls (1741A)

Type: 12.7 cm (5 in.) rectangular CRT, post accelerator, $\approx 7.5\text{ kV}$ accelerating potential, aluminized P31 phosphor.

Graticule: 8×10 div (1 div = 0.85 cm) internal, nonparallax graticule, 0.2 subdivision markings on major horizontal and vertical axes, with markings for transition time measurements. Graticule illumination is achieved with Persistence control set to min.

Beam finder: returns trace to CRT screen.

Z-axis input (Intensity modulation): same as 1740A.

Operating modes: write, store, display, auto-store, auto-erase, and conventional (rear panel control).

Persistence: variable, $\approx 100\text{ ms}$ to 1 min; conventional, $\approx 40\text{ }\mu\text{s}$.

Writing speed, variable persistence and storage: $\approx 200\text{ cm}/\mu\text{s}$ (235 div/ μs) over center 7×9 div (with viewing hood).

Storage time: display mode, at least 10 s at 22°C ; store mode, at least 30 s at 22°C .

Brightness: $\approx 170\text{ cd}/\text{m}^2$ (50 fl) increasing to $\approx 340\text{ cd}/\text{m}^2$ (100 fl) depending on brightness control setting.

Erase time: $\approx 300\text{ ms}$.

Rear panel controls: astigmatism, trace align, conventional push-button, and view time.

Cathode Ray Tube and Controls (1744A)

Type: 12.7 cm (5 in.) rectangular CRT, post accelerator, $\approx 10\text{ kV}$ accelerating potential, aluminized P31 phosphor.

Graticule: 8×10 div (1 div = 0.72 cm) internal graticule, 0.2 subdivision markings on major horizontal and vertical axes, with markings for transition time measurements. Graticule illumination is achieved with Persistence control set to min.

Beam finder, Z-axis input (Intensity modulation): see 1740A.

Operating modes: write, store, display, auto-store, and auto-erase.

Writing speed, variable persistence and storage: $\geq 1800\text{ cm}/\mu\text{s}$ (2500 div/ μs) over center 6×8 div (with viewing hood).

Storage time: store mode, at least 30 s; view mode, at least 10 s; wait time, at least 60 s, at 22°C .

Persistence: variable (100 ms min).

Erase time: $\approx 300\text{ ms}$.

Rear panel controls: astigmatism and trace align.

General

Rear panel outputs: main and delayed gates, 0.8 V to $\geq +2.5\text{ V}$ capable of supplying $\approx 5\text{ mA}$.

Amplitude Calibrator (0°C to $+55^\circ\text{C}$)

Output Voltage: 1 V p-p into $\geq 1\text{ M}\Omega$, 0.1 V p-p into $50\text{ }\Omega$; accuracy, $\pm 1\%$.

Rise time: $\approx 0.1\text{ }\mu\text{s}$.

Frequency: $\approx 1.4\text{ kHz}$.

Power: 100, 120, 220, 240 V ac $\pm 10\%$; 48 to 440 Hz; 100 VA max.

Weight: (1740) net, 13 kg (28.6 lb). Shipping, 15.7 kg (34.6 lb).

(1741, 1743, 1744) net 13.8 kg (30.5 lb). Shipping, 17.7 kg (39 lb).

Operating environment: temperature 0°C to $+55^\circ\text{C}$; humidity to 95% relative humidity at $+40^\circ\text{C}$; altitude, to 4600 m (15,000 ft); vibration, vibrated in three planes for 15 min. each with 0.254 mm (0.010 in.) excursion, 10 to 55 Hz.

Size: (1740A, 1745A) 197 H x 335 W x 597 mm D (7.8" x 13.2" x 23.5") with handle, 492 mm D (19.4 in.) without; (1741A) 616 mm D (24.3 in.) with handle, 552 mm D (21.7 in.) without; (1742A, 1746A) 570 mm D (22.4 in.) with handle, 502 mm D (19.8 in.) without; (1743A) 613 mm D (24.1 in.) with handle, 549 mm D (21.6 in.) without; (1744A) 635 mm D (25 in.) with handle; 511 mm D (20.1 in.) without.

Accessories furnished: one blue light filter HP P/N 01740-02701, one front panel cover, one 2.3 m (7.5 ft) power cord, one vinyl accessory storage pouch, one Operators Guide and one Service Manual, two Model 10041A 10:1 divider probes $\approx 2\text{ m}$ (6.6 ft) long. The 1741A and 1744A also include one Model 10173A RFI filter and contrast screen, and one Model 10140A viewing hood.

Options and Accessories

001: fixed power cord (U.S. only).

002 (1741A): Triggered A vs B Mode; phase shift $\leq 2^\circ$, dc to 5 MHz; internal triggering on channel B.

003: Auto Camera (1741A)

005 (except 1743A, 1744): TV sync

034 (except 1743A, 1744A): built-in DMM (60 Hz)

035 (except 1743A, 1744A): built-in DMM (50 Hz)

091: two 3 m (9.8 ft) 10042A 10:1 probes in lieu of 10041A probes

096: two 1.8 m (6 ft) 10006D 10:1 probes in lieu of 10041A probes.

112: includes 1112A Inverter Power Supply, a portable power source for 1700 series oscilloscopes.

910: extra set of product manuals.

Multimeter kit: HP P/N 01742-69501 (1746A), 01741-69502 (1741A), or 01740-69503 (1740A, 1745A) adapts standard oscilloscope to an Option 034/035 with built-in LED readout. Kit includes a multimeter, top oscilloscope cover, vinyl storage pouch, and mounting hardware.

Ordering Information

1740A 100 MHz Oscilloscope

1741A 100 MHz Storage Oscilloscope

1742A 100 MHz Time Interval Oscilloscope

1743A 100 MHz Time Interval Oscilloscope

1744A 100 MHz Storage Oscilloscope

1745A 100 MHz Large Screen Oscilloscope

1746A 100 MHz Large Screen Oscilloscope

OSCILLOSCOPES

200/275 MHz Delta Time

Models 1715A, 1722B, 1725A

- Two marker delta time measurements
- Direct LED readout with 20 ps resolution (1722B)
- Optional DMM (1715A/1725A)
- Selectable input impedance

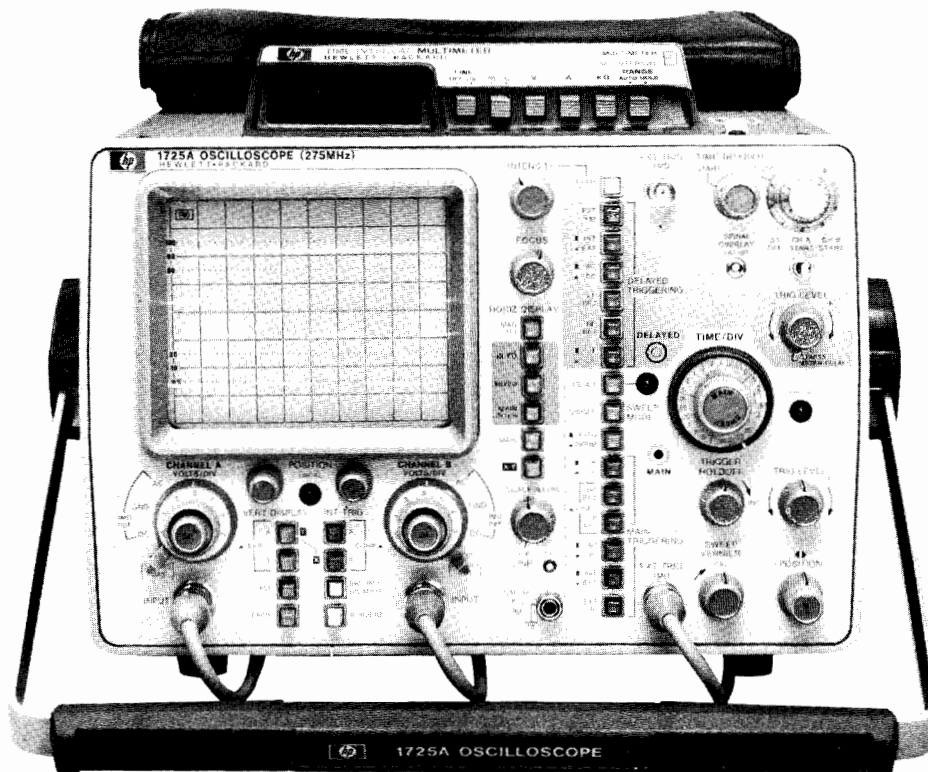

1725A opt 034

1725A/1715A Description

The HP 1725A (275 MHz) and the HP 1715A (200 MHz) are delta time oscilloscopes with an optional DMM for direct readout of time, current, voltage, or resistance measurements. To simplify percentage measurements, both CRT graticules contain reference lines of 0% and 100% amplitude that are 5 divisions apart as well as markings for 10%, 20%, 80%, and 90% amplitude for easy transition time measurements. The 1725A (275MHz) has a vertical deflection factor of 10 mV/div to 5 V/div over the full bandwidth; the 1715A (200 MHz) has 5 mV/div to 150 MHz. Both offer a selectable 50 ohm or one megohm input for the high performance required in laboratory and field applications.

Timing Measurements

The 1725A and the 1715A offer two methods for making timing measurements. One is a single-marker delayed sweep method, which uses the calibrated delay control to measure time relationships accurately. The second uses two intensified markers, which significantly improves accuracy while reducing the time needed to make a measurement. This second method, the delta time measurement technique, allows you to measure transition times, propagation delay, clock phasing, and other high speed digital timing measurements quickly and repeatably.

Optional Digital Multimeter

Adding an optional multimeter to the 1725A or the 1715A improves the accuracy and convenience of delta time measurements as well as improving basic measurement capabilities. Through a switch on the oscilloscope, you can select direct delta time measurements or DMM operation. The DMM mode provides the five most common measurements—ac and dc voltage, ac and dc current, and resistance. The DMM also includes autopolarity, autozeroing, and autoranging used to make direct, convenient measurements.

1722B Description

The HP 1722B is a 275 MHz oscilloscope with 1 ns/div sweep speed, a built-in microprocessor, and a five function LED display for precise real-time measurements. In addition to the conventional volts versus time CRT display, the 1722B gives you a direct readout of delta time, frequency, dc voltage, instantaneous waveform voltage, and percent amplitude.

Timing Measurements

With the 1722B, time interval measurements can be made between two events on channel A, two events on channel B, or between an event beginning on channel A and ending on channel B. The 1722B's microprocessor not only keeps track of the distance between the two markers but automatically expands the measurement resolution by a factor of 10 whenever the two markers are within one division of each other. The microprocessor also interrogates the function switches to help prevent inaccurate measurements.

Frequency Measurements

The 1722B gives an automatic 3 or 4 digit display of the reciprocal of time. This eliminates the need for calculations when setting up clock frequencies and measuring the frequency of repetition rate of a waveform.

DC Voltage Measurements

The input (dc volts) mode provides a direct digital readout of the average value of a waveform at the input to channel A. The built-in DVM measurement is made using a successive approximation algorithm controlled by the microprocessor. This allows you to establish a reference level with respect to any voltage and enables differential dc measurements.

Instantaneous Voltage Measurements

In the position mode, you can measure the voltage at any point on a waveform in channel A without needing to count divisions from a base line and multiply by the attenuator setting. This mode is useful for measuring peak voltages, crossover, and threshold points in logic circuits, or for any time you need to know a precise voltage at a particular point on a waveform.

- 2000 cm/ μ s variable persistence and stored writing speed
- Minimum blind time, auto intensity circuit
- 275 MHz bandwidth, 10 mV/div with 1 M Ω or 50 Ω input
- Time interval measurements and optional DMM

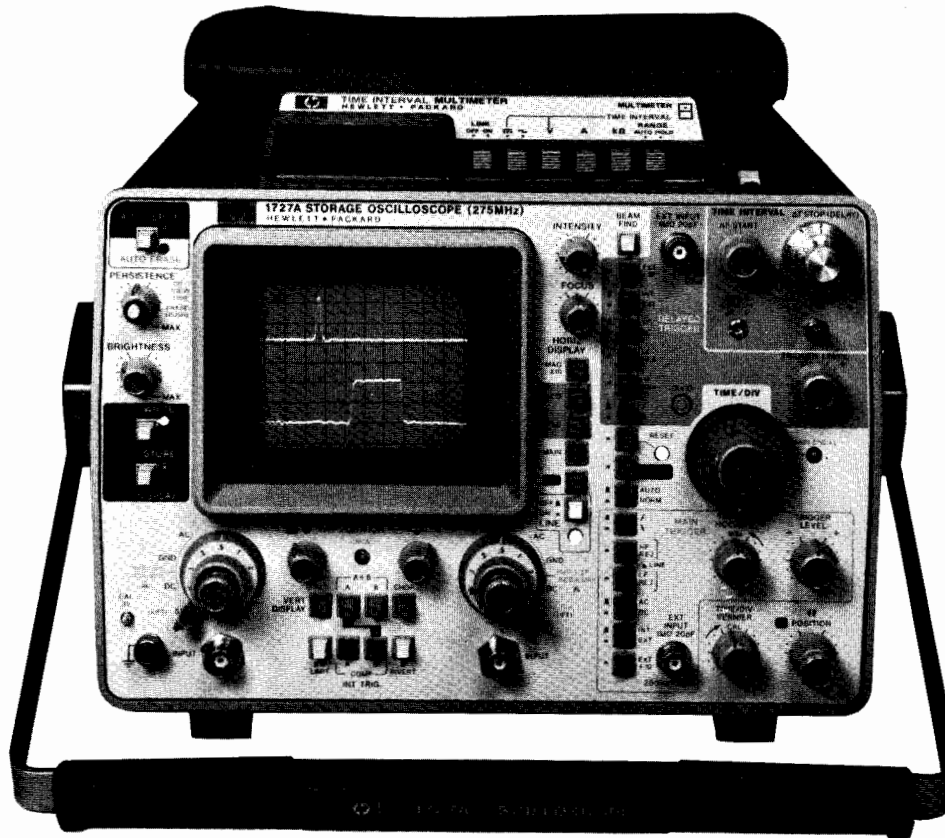

1727A with opt 034

1727A Description

Hewlett-Packard's 275 MHz 1727A variable persistence/storage oscilloscope offers 2000 cm/ μ s writing speed in both the variable persistence and single-shot storage modes. The fast writing speed and high bandwidth make the 1727A ideal for viewing and analyzing narrow pulses in the physical sciences as well as glitches and noise pulses in digital environments. Signals with rise times as fast as 1.27 ns (4 div) can be captured and displayed in the single-shot mode.

Conveniently grouped variable persistence storage controls, front panel color coding, LED indicators, and automatic operating modes make the 1727A a very functional, high-speed storage oscilloscope. Additional features that provide exceptional versatility and ease of use include dual marker time interval measurements; an auto-intensity circuit to simplify the setup of a sharp, nonblooming trace; and selectable input impedance (1 M Ω /50 Ω) for both general purpose probing and high fidelity, high frequency signal capture with the built-in 50 ohm impedance matching.

Expansion Storage

The expansion storage CRT (refer to 1744A for illustration) has a miniature storage mesh, about the size of a postage stamp, and an electronic lens system to present well-defined, sharp traces at the high writing speed of 2000 cm/ μ s in a variety of operating modes. The fast CRT writing speed is obtained over the full display quality area. Other convenience features include an automatic focus circuit that maintains a crisp display with changes in intensity, and an auto intensity circuit that minimizes blooming and reduces operator concern about CRT damage.

Fast Writing Speed and High Bandwidth

The ability to write at 2000 cm/ μ s in the variable persistence mode makes the 1727A a general purpose instrument. Using the

variable persistence mode, the effective writing speed can be increased by integrating repetitive signals. With the 1727A, only two or three repetitions of a signal in a 10 second time period are needed to view any signal compatible with the vertical and horizontal specifications. For example, a 275 MHz sine wave with an amplitude of 8 divisions at a sweep speed of 1 ns/div has a maximum spot velocity of 5028 cm/ μ s and only requires about three repetitions for viewing.

The following table is a quick reference guide for determining the single-shot signals that can be captured by a 1727A.

Amp p-p	Sine Wave MHz	Observed Pulse Tr	Sweep Speed ns/div	Req Writing Speed cm/ μ s
4 div		1.27 ns	1	1952
4 div		1.27 ns	10	1816
3 div	275		1	2000
3 div	275		10	1867
4 div	200		1	1948
4 div	200		10	1811

Delta Time Measurements

In the variable persistence mode, the 1727A can make delta time measurements using the two marker delta time system. This delta time system simplifies time interval measurements while improving both accuracy and resolution. In the delta time mode, Start and Stop markers are alternately displayed on the main intensified sweep. The time interval between these markers can be displayed on the optional DMM or is available as a scaled voltage output, on the rear panel, that is compatible with most DVMs. Time interval measurements may also be made without a DVM using the helidial for determining the measurement.

OSCILLOSCOPES

200/275 MHz

Models 1715A, 1722B, 1725A, 1727A

Specifications

Vertical Display Modes

Channel A; channel B; A and B displayed alternately on successive sweeps (ALT); A and B displayed by switching between channels at ≈ 1 MHz rate with blanking during switching (CHOP); A plus B (algebraic addition); X-Y (A vs. B).

Vertical Amplifiers (2)

Bandwidth: (3 dB down from 6 div reference signal).

DC-coupled: (1722B, 1725A, 1726A, 1727A) dc to 275 MHz, (1715A) dc to 200 MHz 10 mV/div to 5 V/div (to 150 MHz at 5 mV/div, 1715A), in both 50 Ω and high Z input modes.

AC-coupled: lower limit ≈ 10 Hz.

Bandwidth limit: limits upper bandwidth to ≈ 20 MHz.

Rise time: (1722B, 1725A, 1727A) < 1.3 ns; (1715A) < 1.75 ns at 10 mV/div to 5 V/div, < 2.3 ns at 5 mV/div; (1726A) < 1.27 ns, measured from 10% to 90% points of a 5 div input step.

Deflection factor: ranges, 10 mV/div to 5 V/div (9 calibrated positions) in 1, 2, 5 sequence, $\pm 2\%$ attenuator accuracy; 5 mV/div to 5 V/div (10 calibrated positions) in 1715A; vernier, extends max deflection factor to ≥ 12.5 V/div.

Polarity: channel B may be inverted.

Input coupling: selectable, ac or dc, 50 Ω (dc) or ground.

Input RC (selectable): ac and dc, 1 M Ω $\pm 2\%$ shunted by ≈ 11 pF; 50 Ω , 50 Ω $\pm 2\%$; SWR (1722B, 1725A, 1727A) ≤ 1.3 on 10, 20, and 50 mV ranges, < 1.15 on all other ranges; SWR (1715A) ≤ 1.3 on 5, 10, 20, and 50 mV ranges and < 1.15 on all other ranges.

Max input: 1 M Ω , ± 250 V (dc + pk ac) at ≤ 1 kHz; 50 Ω , 5 V rms. **A+B operation:** amplifier, bandwidth and deflection factors are unchanged; channel B may be inverted for A-B operation; Differential (A-B) Common Mode, CMR is ≥ 40 dB from dc to 5 MHz decreasing to 26 dB at 50 MHz. Common mode signal amplitude equivalent to 12 div with one vernier adjusted for optimum rejection.

Vertical Output (rear panel)

Amplitude: one div of vertical deflection produces ≈ 100 mV output, dc to 50 MHz in 1722B, 1725A, 1726A, 1727A, dc to 25 MHz in 1715A.

Cascaded deflection factor: 1 mV/div with both vert channels set to 10 mV/div. Bandwidth, dc to 5 MHz (with bandwidth limit). Source resistance $\approx 100\Omega$ (1726A: $\approx 50\Omega$); selection, trig source set to A selects channel A output, to B selects channel B output.

Horizontal Display Modes

Main, main intensified (1715A, 1722B, 1725A, 1726A), delayed, mixed, X-Y, and mag X10. The 1727A main intensified mode is automatically selected whenever the delayed time base is turned on.

Main Time Base

Sweep

Ranges: 10 ns/div to 0.5 s/div (24 ranges) 1, 2, 5 sequence.

Accuracy

Main Sweep Time/Div	Accuracy (0°C to +55°C)	
	X1	X10
10 ns to 50 ns	$\pm 3\%$	$\pm 5\%$
100 ns to 20 ms	$\pm 2\%$	$\pm 3\%$
50 ms to 0.5s	$\pm 3\%$	$\pm 3\%$

Vernier: extends slowest sweep to at least 1.25 s/div.

Magnifier: extends fastest sweep to 1 ns/div.

Sweep Mode

Normal: sweep is triggered by internal or external signal.

Automatic: baseline displayed in absence of input signal. Triggering is same as normal above ≈ 40 Hz.

Single: in Normal, sweep occurs once with same triggering as Normal, reset arms sweep and lights indicators; in Auto, sweep occurs once each time Reset is pressed (1727A). Erase pushbutton arms sweep, lights indicator, and performs the Reset function immediately following the erase cycle.

Triggering

Source: channel A, B, Comp, or line frequency.

Internal: dc to 100 MHz on signals causing ≥ 0.5 div vertical deflection, increasing to 1 div (1.5-1726A) of vert deflection at 300 MHz (275MHz, 1726A; 200 MHz, 1715A) in all display modes. Line freq. triggering selectable.

External: dc to 100 MHz on signals ≥ 50 mV p-p increasing to 100 mV p-p (150 mV p-p, 1726A) at 300 MHz (200 MHz, 1715A, 275 MHz, 1726A). Max input, ± 250 V (dc + peak ac) at ≤ 1 kHz. Input RC ≈ 1 M Ω shunted by ≈ 15 pF.

Trigger Level and Slope

Internal: at any point on the vertical waveform displayed.

External: +1.0 V to -1.0 V (+10 V to -10 V in $\div 10$ mode).

Coupling: ac, dc, LF REJ, or HF REJ.

Trigger holdoff: variable, to > 1 sweep from 10 ns/div to 50 ms/div.

Delayed Time Base

Sweep

Ranges: 10 ns/div to 20 ms/div (20 ranges) in 1, 2, 5 sequence.

Accuracy: same as main time base.

Triggering (except 1726A)

Internal: same as main time base, no line frequency triggering.

Starts after delay: sweep starts at end of delay period.

Trigger: with delayed trigger level control out of detent (starts after delay) delayed sweep is triggerable at end of delay period.

Delay time range: 0.5 to 10X Main Time/Div settings of 20 ns to 0.5 s (min delay 50 ns).

External triggering, external input RC, max external input, trigger level and slope, and coupling are same as main time base.

Triggering (with ΔT off-1726A)

Auto: delayed sweep automatically starts at end of delay period.

Trig: delayed sweep is triggerable at end of delay period. Vary Start (or Delay) control to adjust the arming point of the delayed sweep trigger.

Delayed trigger source: channel A or channel B can be selected as a trigger source.

Differential Time Accuracy (1715A, 1725A, 1727A)

Main Time Base Setting	Accuracy (+15°C to +35°C)
50 ns/div to 20 ms/div	$\pm (0.5\% \text{ of reading} + 0.1\% \text{ of full scale})$
20 ns/div	$\pm (1\% \text{ of reading} + 0.2\% \text{ of full scale})$
50 ms/div to 0.5 s/div	$\pm 3\%$

Delay jitter: $< 0.005\%$ of max delay in each step.

Stability (0°C to +55°C): short term 0.005%. Temperature, $\pm 0.03\%/^{\circ}\text{C}$ deviation from calibration temperature range.

Time Interval (ΔT -1726A)

Function: measures the time interval between start and stop events on one or two channels, in all operating modes except X-Y.

Overlap Mode: the CRT is used as a visual comparator to measure time intervals between start and stop events. Time interval measurements are valid when start/stop delayed sweeps are overlapped or aligned on a vertical graticule (in ΔT overlap with mag X10 if required). Known relationships between the delayed display and the stopping point for the counting process required for a time interval measurement enable the use of this technique.

ΔT Overlap: only the intensified portions (Start/Stop) of main sweep are displayed. With ΔT off, the intensified single delayed sweep is displayed.

Marker Width: in main display, this control varies the width of the intensified start/stop markers. In ΔT overlap display, the width (i.e., time window) of the displayed intensified region varies. With ΔT off, this control is non-functional.

Start (or Delay)/Stop (ΔT Only): controls position of the start/stop intensified markers. Markers move continuously in overlap mode, and they jump discretely (from trigger event to trigger event) in triggered mode. With ΔT off, Start is the delay control for the single intensified marker.

Dly'd (ΔT Overlap): displays delayed sweep (i.e., the intensified

portions of main sweep).

ΔT: activates time interval readout between start and stop events.

1/ΔT: displays reciprocal of ΔT measurement.

Fast mode: used in conjunction with ΔT or 1/ΔT; reduces number of averages by a factor of 10. Increases uncertainty of least significant digit displayed.

Counting LED: indicates a measurement in progress.

Main time/div setting: automatically determines the number of averages required for a measurement.

Triggered mode: measures time interval between start trigger point and stop trigger point. Start/Stop trigger level controls adjust the desired trigger point when the corresponding button on the time interval module is engaged.

Start/stop trigger level: indicates through the LED readout the desired trigger point for start/stop events. These controls set the reference for the trigger point in the trigger chip. Actual trigger point will vary with slope, slew rate, and trigger voltage selected.

Stop Lvl equals start Lvl: automatically sets stop trigger level equal to start trigger level.

Start/stop slope selection: indicates positive or negative slope for start/stop trigger point.

ΔT Accuracy (1726A)

Overlap mode: there are three components of accuracy in this mode: 1) CRT screen resolution; 2) resolution of the time interval averaging process; and 3) uncertainty in the counting process. Table A summarizes accuracy in all operating conditions (Channel A, Channel B, ALT, CHOP, A+B, A-B).

Main Time/Div	Dly'd Time/Div	Accuracy†
20 ns	10 ns	±100 ps
50 ns	10 ns, 20 ns	±50 ps
.1 μs, .2 μs, .5 μs	10 ns, 20 ns	±200 ps
.1 μs, .2 μs, .5 μs	50 ns	±300 ps
.2 μs, .5 μs	.1 μs	±400 ps
.5 μs	.2 μs	±600 ps
1.0 μs, 2.0 μs	all	±2 ns
5.0 μs, 10.0 μs, 20 μs	all	±10 ns
50 μs, 1 ms, .2 ms	all	±100 ns
.5 ms, 1.0 ms, 2.0 ms	all	±1 μs
5.0 ms, 10 ms, 20 ms	all	±10 μs
50 ms, 1 s, 2 s, 5 s	all	±100 μs

†Add ±50 ps if measurement is made relative to the first pulse. Accuracy is not specified if measurements are made relative to the last 0.5 divisions of main sweep.

Triggered mode: for accuracy greater than ±0.5 ns, all measurements should be verified with the Overlap mode. Absolute accuracy on measurements made without Overlap mode verification can be determined by adding ±300 ps to the accuracy specifications in Table A. A number of variables affect the accuracy of this mode. Accuracy is composed of 1) "arm/walk" errors, which can be minimized by viewing triggered measurements in Dly'd (ΔT Overlap) display; 2) trigger level vs trigger point errors (this error is minimized when time interval measurements are made at the same Start/Stop voltage on similar sloped edges); 3) counting process errors; 4) time interval averaging resolution; and 5) crystal time base accuracy of 0.001% of measurement.

Time Interval (Δ time mode—1715A, 1725A, 1727A)

Function: measures time interval between two events on channel A (A display), on channel B (B display), or starting from an event on either A or B and ending with an event on either A or B (alt display).

Time interval output voltage: from 50 V to 100 mV full-scale.

Accuracy: time interval accuracy plus DVM accuracy.

Main Time Base Setting	Accuracy (+20°C to +30°C)
100 ns/div to 20 ms/div	±0.5% of reading ±0.05% of fs
50 ns/div*	±0.5% of reading ±0.1% of fs
20 ns/div*	±0.5% of reading ±0.2% of fs
50 ms/div to 0.5 s/div	±3%

Time Interval (1722B)

Time interval delay: continuously variable from 10 ns to 5 s.

Delay jitter: refer to Time Interval Measurement, Stability.

Time Interval Measurement (Time)

Function: measures time interval between two events on channel A (A display), on channel B (B display), or between two events starting from an event on A and one ending on channel B (alt display).

Time Interval Accuracy

Main Time Base Setting	Accuracy (+20°C to +30°C)
100 ns/div to 20 ms/div	±0.5% of measurement ±0.02% of full scale (for measurements <1 cm). For measurements >1 cm, ±0.5% of measurement ±0.05% of full scale.
50 ns/div*	±0.5% of measurement ±0.06% of full scale.
20 ns/div*	±0.5% of measurement ±0.15% of full scale.
50 ms/div to 0.5 s/div.	±3%

*Starting after 60 ns of sweep.

Resolution: intervals <1 cm, >0.01% of full scale; intervals >1 cm, 0.1% of full scale; max display resolution, 20 ps.

Stability (0° to +55°C): short term, <0.01%. Temperature, ±0.03%/°C deviation from calibration temperature range.

Reciprocal of Time Interval Measurement (1/time)

Accuracy, resolution, stability: see time interval measurements.

Mixed Time Base

Dual time base in which the main time base drives the first portion of sweep and the delayed time base completes the sweep.

X-Y Operation

Bandwidth

Y-axis (channel A), same as channel A;

X-axis (channel B), dc to >1 MHz.

Phase difference: <3°, dc to 1 MHz (3 MHz, 1722B).

Cathode-Ray Tube and Controls (1715A, 1722B, 1725A, 1726A)

Type: post accelerator, ≈ 20.5 kV, aluminized P31 phosphor.

Graticule: 8 x 10 div internal graticule, 0.2 subdiv markings on major horiz and vert axes, 1 div = 1 cm. Internal floodgun illum.

Beam finder: returns trace to CRT screen.

Intensity modulation (Z-axis): +8 V, ≥50 ns (1726A:>(-2) V and >75 ns) width pulse blanks trace of any intensity, usable to 20 MHz for normal intensities. Input R, 1 kΩ ± 10%. Max input, ±10 V (dc + peak ac).

Auto-focus: maintains beam focus with variations of intensity.

Intensity limit: limits beam current to simplify operation. Circuit response time ensures full writing speed.

Cathode-Ray Tube and Controls (1727A)

Type: post accelerator, ≈ 9.5 kV, aluminized P31 phosphor.

Graticule: 8 x 10 div internal graticule, 0.2 subdivision markings on major horiz and vert axes, 1 div = 0.72 cm.

Beam finder: returns trace to CRT screen.

Intensity modulation (Z-axis): +4V, ≥50 ns width pulse blanks trace of any intensity, usable to 20 MHz for normal intensities. Input R, 1 kΩ ± 10%. Max input, ±20V (dc + peak ac).

Operating modes: write, store, display, auto-store, and auto-erase.

Writing speed, variable persistence and storage: ≥2000 cm/μs (2775 div/μs) over center 6 x 8 div (with viewing hood).

Storage time (at 22°C): display mode, at least 10 s; store mode, at least 30 s; wait time, at least 60 s.

Persistence: variable, ≥100 ms.

Erase time: ≈ 300 ms.

Intensity limit: limits beam current to simplify operation. Circuit response time ensures full writing speed.

Auto-focus: maintains beam focus with variations of intensity.

General

Rear panel controls: astigmatism and trace align (both X and Y). **Rear panel outputs:** main and delayed gates, -0.7 V to +1.3 V capable of supplying ≈ 3 mA; and vertical output.

Calibrator: type, 1 kHz ± 15% (±10%, 1722B) square wave; 3 V p-p ± 1%, <0.1 μs transition time.

Power: 100, 120, 220, and 240 Vac, -10% + 5%; 48 to 440 Hz; 110 VA max (1726A: 160 VA max).

Ordering Information

1715A 200 MHz Oscilloscope

1722B 275 MHz Oscilloscope with Microprocessor

1725A 275 MHz Oscilloscope

1726A 275 MHz Time Interval Oscilloscope

1727A 275 MHz Storage Oscilloscope

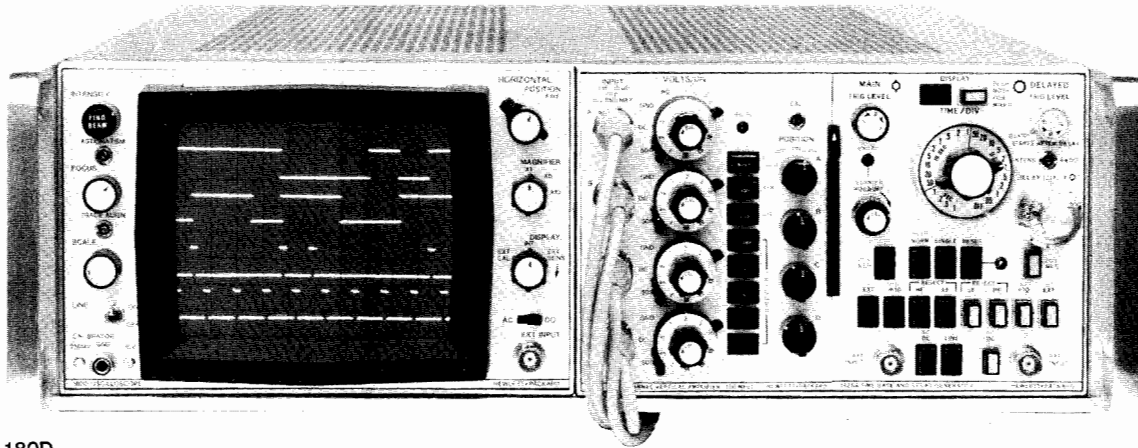

180D

180C/D, 181AR Specifications

Cathode-Ray Tube and Controls

Type: post accelerator, 15 kV (180), 8.5 kV (181); aluminized P31 phosphor.

Graticule: 8 × 10 div internal graticule, 0.2 div subdivisions on major axes; (180) 1 div = 1 cm, (181) 1 div = 0.95 cm.

Beam finder: returns trace to CRT screen.

Intensity modulation (external input): input, $\approx +2$ V, ≥ 50 ns pulse width blanks trace of normal intensity; input R ≈ 50 k Ω ; Max input, ± 20 V (dc + peak ac) at ≤ 1 kHz.

Persistence, Storage (181AR)

Persistence: normal, ≈ 40 μ s; variable, <0.2 to >1 min.

Writing speed: write, >20 cm/ms; max write, >5 cm/ μ s.

Brightness: >342.6 cd/m² (100 f).

Storage time: from Write to Store, reduced intensity for >1 hr; to View, normal intensity for >1 min. From max Write to Store, reduced intensity for >5 min.; to View, normal intensity for >15 s, pushbutton erasure takes ≈ 300 ms.

Horizontal Amplifier

External Input

Bandwidth: dc-coupled, dc to 5 MHz; ac-coupled, 5 Hz to 5 MHz.
Deflection factor: 1 V/div, X1; 0.2 V/div, X5 (180, 181); 0.1 V/div, X10; accuracy, $\pm 5\%$; dynamic range ± 20 V.

Max input: 600 V dc (ac-coupled input).

Input RC: ≈ 1 M Ω shunted by ≈ 30 pF.

Sweep magnifier: X10, X5 (180, 181); overall accuracy, $\pm 5\%$.

Calibrator: ≈ 1 kHz square wave, <3 μ s rise time; 250 mV p-p and 10 V p-p into 1 M Ω , $\pm 1\%$.

180 Vertical Plug-Ins

Model No.	1801A	1805A	1809A
Bandwidth MHz	50	100	100
Min. deflection factor/div	5 mV (500 μ V) Opt 001 cascaded	5 mV	10 mV
Channels	2 (Opt 001 one cascaded)	2 (1 cascaded)	4
Input RC	1 M Ω /25 pF	1 M Ω /13 pF or 50 Ω	1 M Ω /12 pF or 50 Ω
Differential	yes	yes	yes
A \pm B	yes	yes	yes

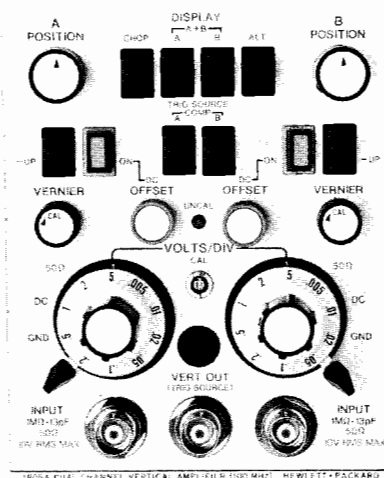

1805A, 100 MHz 2 channel

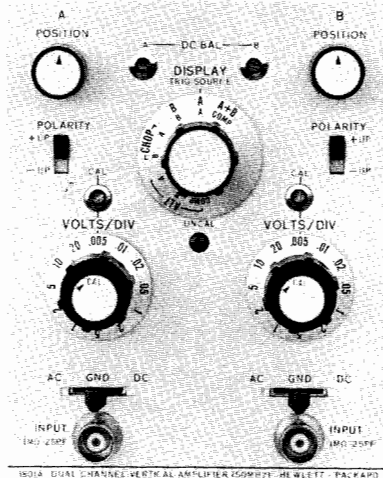

1801A, 50 MHz 2 channel

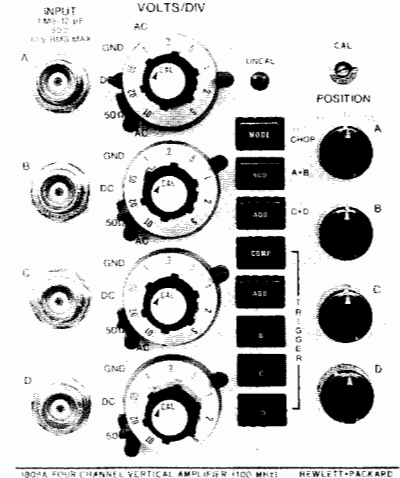

1809A, 100 MHz 4 channel



180 Time Base Plug-Ins

Model No.	1821A	1825A
Ext Trig Freq (MHz)	100	150
Int Trig Freq.	Determined by Vert. Amp. Plug-in.	
Sweep Speeds/div'	10 ns	5 ns
	1 s	1 s
Delayed and Mixed Sweep	Yes	Yes

1. Includes X10 mainframe magnification.
See data sheet for additional specifications.

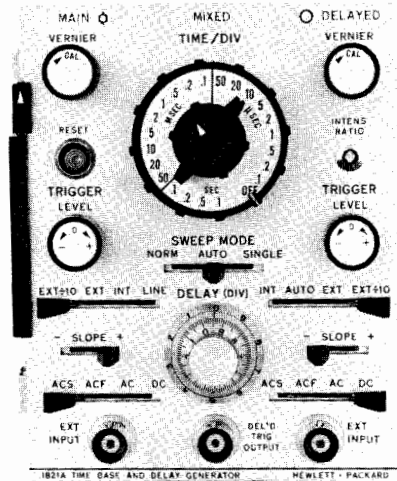

1821A, 50 MHz triggering

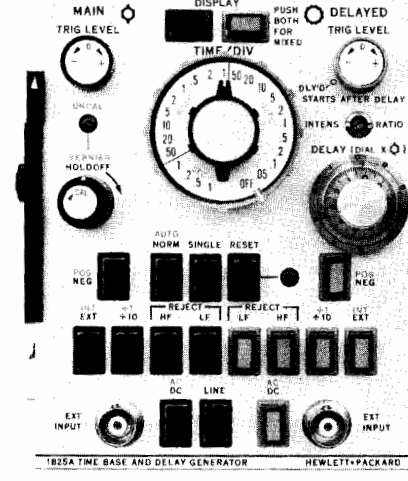

1825A, 100 MHz triggering

Ordering Information-- 180 Series

180C Cabinet Style Main Frame

Opt 010: deletes rear panel outputs for main and delayed gates and main and delayed sweeps

Opt 910: additional Operating and Service Manual

180D Rack Style Mainframe

Opt 010: (see 180C Option 010)

Opt 910: additional Operating and Service Manual

181AR Storage Mainframe, Rack Style

Opt 910: additional Operating and Service Manual

1821A Time Base and Delay Generator

Opt 910: additional Operating and Service Manual

1825A Time Base and Delay Generator

Opt 910: additional Operating and Service Manual

180 Series (cont.)

1801A 50 MHz Dual Channel Vertical Amplifier

Opt 001: Channel B output and X5 magnifier

Opt 090: 1.8 m (6 ft) 10006D probes in lieu of 10004D

Opt 091: 3 m (10 ft) 10005D probes in lieu of 10004D

Opt 910: additional Operating and Service Manual

1805A 100 MHz Dual Channel Vertical Amplifier

Opt 910: additional Operating and Service Manual

1809A 100 MHz 4 Channel Vertical Amplifier

Opt 910: additional Operating and Service Manual

500 kHz General Purpose 1200B, 1201B

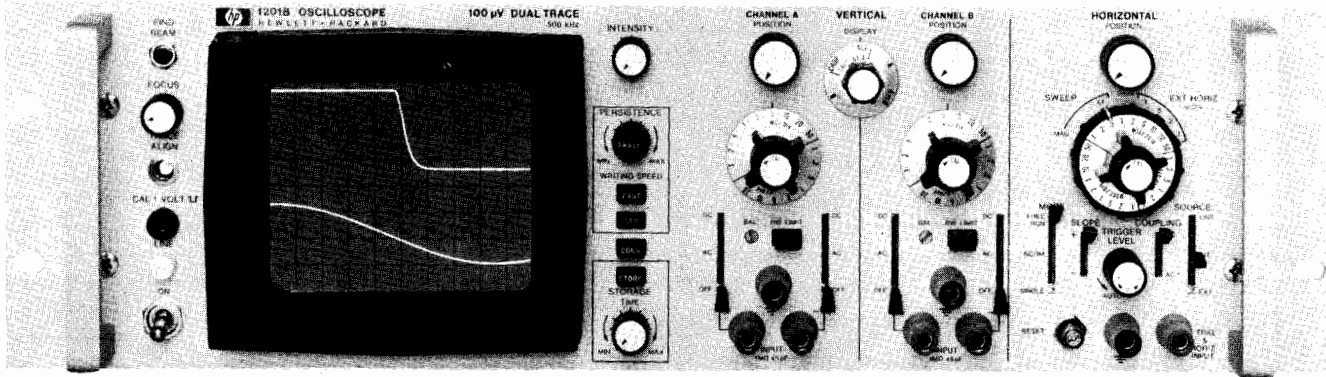

1201B

Options

006: rear input terminals wired in parallel with front panel vertical and horizontal input terminals. Vertical input shunt capacitance is increased to ≈ 100 pF. Horizontal input shunt capacitance is increased to ≈ 75 pF.

009: storage model only, remote erase through rear panel banana jack, shorting to ground provides erasure (not compatible with Opt 006).

015: vertical channel signal outputs through rear panel connectors.

910: additional Operating and Service Manual

The 1200B and 1201B (storage) are general purpose oscilloscopes for low frequency applications.

Ordering Information

1200B Dual Channel, 100 μ V Oscilloscope

1201B Dual Channel, 100 μ V Storage Oscilloscope

OSCILLOSCOPES

Probes and Other Oscilloscope Accessories

Miniature Oscilloscope Probes

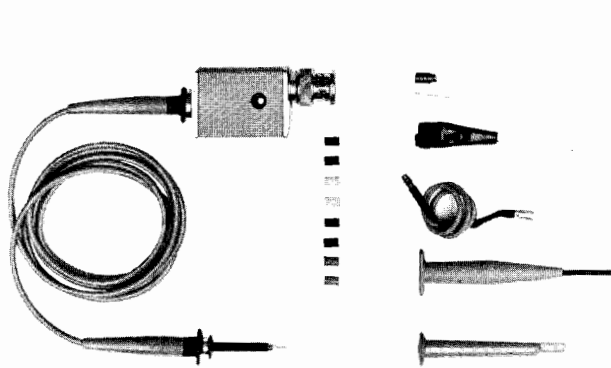

10017A, 10018A, 10040A, 10041A, 10042A

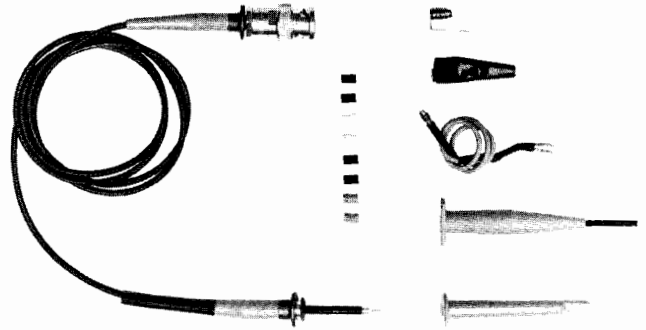

10026A, 10027A

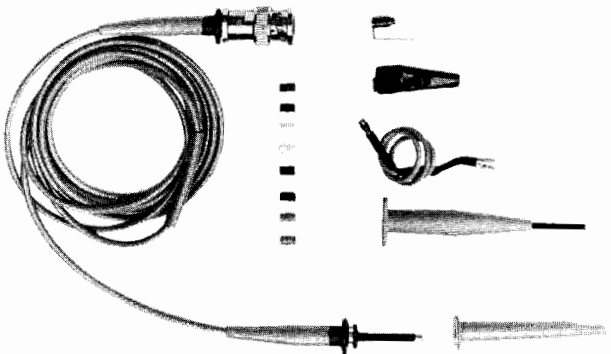

10021A, 10022A

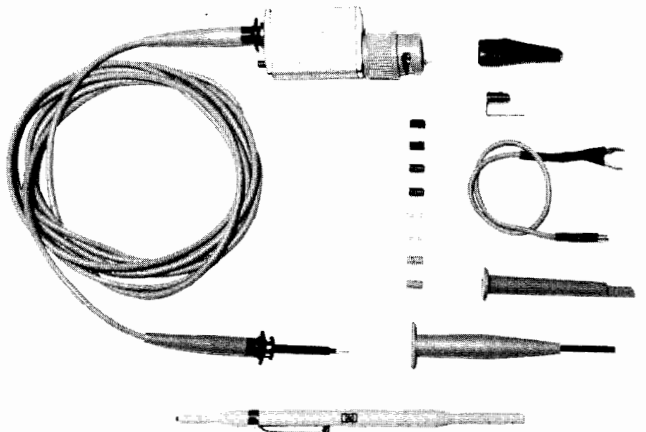

10080A, 10081A, 10082A, 10083A, 10084A

*OSCILLOSCOPE/MINIATURE PROBE COMPATIBILITY AND PROBE CHARACTERISTICS							
HP Oscilloscope/ Plug-in Model No. and Bandwidth	Probe Model No.	Approx Overall Length in Metres (ft)	Division Ratio	Input R	Shunt Capacitance	Compensates Oscilloscope Input	Max dc Volts
1725A/275 MHz 1722B/275 MHz 1727A/275 MHz	10017A	1 m (3.3)	10:1	1 MΩ	8 pF	9 to 14 pF	300
1715A/200 MHz 1809A/100 MHz 1805A/100 MHz	10018A	2 m (6.6)	10:1	1 MΩ	10 pF	9 to 14 pF	300
1740A, 1741A, 1743A, 1744A, 1745A, 1746A 100 MHz	10040A	1 m (3.3)	10:1	1 MΩ	9 pF	20 to 30 pF	300
	10041A	2 m (6.6)	10:1	1 MΩ	12 pF	20 to 26 pF	300
	10042A	3 m (9.8)	10:1	1 MΩ	15 pF	20 to 24 pF	300
1908/100 MHz 1950A/100 MHz	10080A**	1 m (3.3)	10:1	1 MΩ	9 pF	10-20 pF	300
	10081A**	2 m (6.6)	10:1	1 MΩ	12 pF	12-20 pF	300
	10082A**	3 m (10)	10:1	1 MΩ	14 pF	14-18 pF	300
	10083A**	1 m (3.3)	1:1		45 pF		300
	10084A**	2 m (6.6)	1:1		68 pF		300
	10085A**	2m (6.6)	10:1	1 MΩ	12 pF	12-20 pF	300
All scopes with high Z inputs (may reduce bandwidth)	10021A	1 m (3.3)	1:1		36 pF		300
	10022A	2 m (6.6)	1:1		62 pF		300
All scopes with 50 Ω inputs and with a 50 Ω source impedance	10026A	1 m (3.3)	1:1	50 Ω			100
	10027A	2 m (6.6)	1:1	50 Ω			100

Accessories supplied with each probe: one retractable hook tip, one IC probe tip adapter, one alligator clip, one 20 cm (8 in.) ground lead, eight color-coded indicator sleeves, one grounding spring, and one Operating Note.
*These miniature probes may be used with other oscilloscopes and test instruments with the proper input capacitance with no noticeable bandwidth degradation. However, due to variations of input characteristics, the probes may require recalibration for optimum performance.

**The 10080 Series miniature probes include a Feature Enable pushbutton for exclusive use with the 1980 Oscilloscope Measurement System.



Standard probes

For measurements in standard circuits where miniature probes are not a requirement, Hewlett-Packard offers a wide selection of standard size probes.

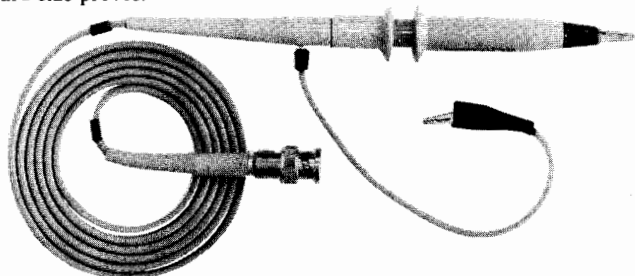

10001-10003A

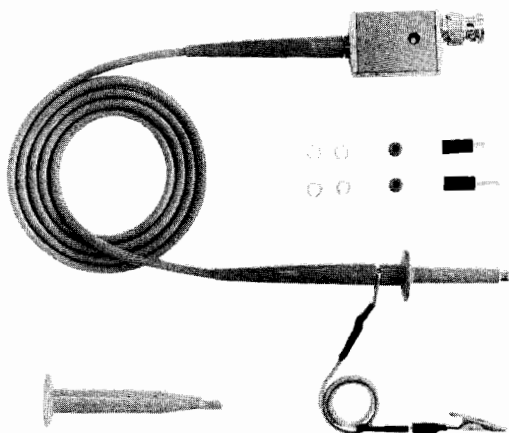

10004D-10006D, 10014A, 10016B

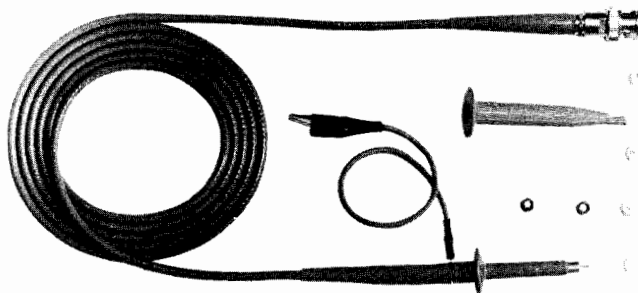

10007B, 10008B

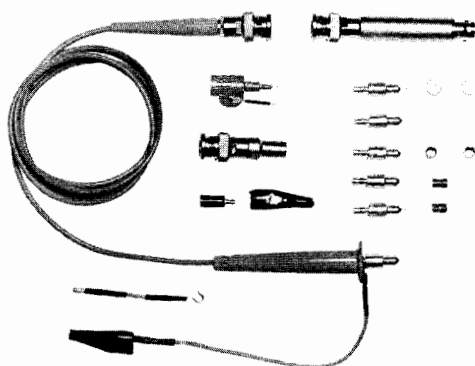

10020A

Standard Probe Instrument Compatibility

Scope/ Plug-in	1200 Series	1715A 1725A 1722B 1727A	1740A thru 1744A	1801A	1805A 1809A
Probe					
10001A	X		L	L	
10001B	X		L	L	
10002A	X		L	L	
10002B	X		L	L	
10003A	X		L	L	
10004D			X	X	
10005D			L	X	
10006D			X	X	
10007B	X	L	L	L	L
10008B	X	L	L	L	L
10013A	X			L	
10014A		X			X
10016B		X			X
10020A		X	X		X
1120A		X	X		X
1124A		L	L		L

Notes:

X Indicates that probe will maintain the bandwidth of the instrument.

L Indicates that probe may limit the bandwidth of the instrument.

Standard Divider Probe Characteristics

Model No.	Division Ratio	Resistance (M Ω)	Shunt Capacitance (pF)	Compensates Scope Input C (pF)	Max DC Volts	Overall Length m (ft)
10001A	10:1	10	10	15-55	600	1.5 (5)
10001B	10:1	10	20	15-45	600	3 (10)
10002A	50:1	9	2.5	15-55	1000	1.5 (5)
10002B	50:1	9	5	15-55	1000	3 (10)
10003A	10:1	10	10	15-55	600	1.3 (4)
10004D	10:1	10	10	20-30	500	1.1 (3.5)
10005D	10:1	10	17	20-30	500	3 (10)
10006D	10:1	10	14	20-30	500	1.8 (6)
10007B	1:1	—	40	—	600	1.1 (3.5)
10008B	1:1	—	60	—	600	1.8 (6)
10013A	10:1	10	13	24-45	500	1.8 (6)
10014A	10:1	10	10	9-13	500	1.1 (3.5)
10016B	10:1	10	14	9-13	500	1.8 (6)

10020A Resistive Dividers

Division Ratio	Input R* (ohms)	Division Accuracy	Max V** (rms)	Input C (pF)
1:1	50	—	6	—
5:1	250	$\pm 3\%$	9	<0.7
10:1	500	$\pm 3\%$	12	<0.7
20:1	1000	$\pm 3\%$	15	<0.7
50:1	2500	$\pm 3\%$	25	<0.7
100:1	5000	$\pm 3\%$	35	<0.7

*When terminated in 50 ohms.

**Limited by power dissipation of resistive element.

Probe length (overall): \approx 1.2 m (4 ft).

Weight: net, 0.45 kg (1 lb). Shipping, 1.4 kg (3 lb).

Accessories supplied: blocking capacitor, BNC adapter tip, 6-32 adapter tip, alligator tip, probe handle, cable assy's 5.1 cm (2 in.) & 15.2 cm (6 in.) ground, spanner tip, insulating caps, colored sleeves.

10020A Resistive Divider Probe Kit

OSCILLOSCOPES

Probes and Other Oscilloscope Accessories (cont.)

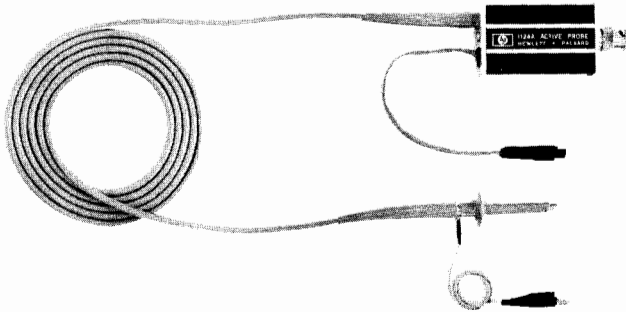

1124A

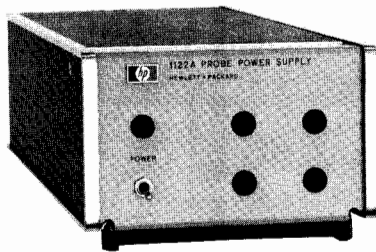

1122A

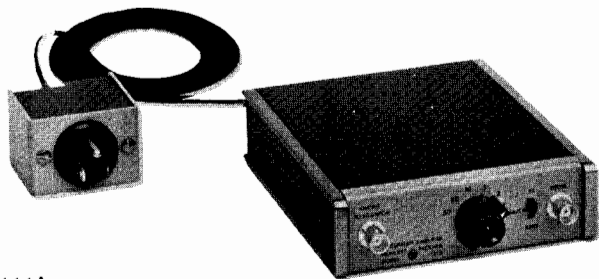

1111A

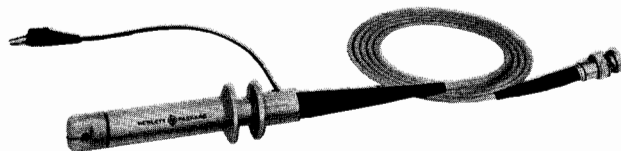

1110B

1124A 100 MHz Active Probe

Model 1124A Active Divider Probe provides high voltage, general purpose probing capabilities for instruments having 50 ohm inputs without selectable high impedance inputs. This 10 megohm 10 pF probe allows direct measurements of 100 volts, in the 100:1 division ratio mode, from dc to 100 MHz. In the 10:1 division ratio mode, input voltage range is ± 10 volts. Power is supplied by instruments with probe power jacks or the 1122A probe power supply.

1124A Specifications

(Measured when connected to a 50 Ω load.)
Bandwidth: (measured from a terminated 50 Ω source) dc-coupled,

dc to 100 MHz; ac-coupled, 2 Hz to 100 MHz.

Pulse response: (measured from a terminated 50 Ω source) transition time, < 3.5 ns; perturbations, 5% p-p. Measured with pulse transition time of > 2.5 ns.

Attenuation ratio: 10:1 $\pm 5\%$; 100:1 $\pm 5\%$.

Dynamic range: X10, ± 10 V; X100, ± 100 V.

Input RC: 10 M Ω shunted by ≈ 10 pF.

Maximum Safe Input

DC-coupled: X10, ± 300 V (dc + peak ac) ≤ 100 MHz; X100, ± 500 V (dc + peak ac) ≤ 100 MHz.

AC-coupled: X10, ± 300 V (dc + peak ac) ≤ 100 MHz. DC component must not exceed ± 200 V; X100, ± 500 V (dc + peak ac) ≤ 100 MHz. DC component must not exceed ± 200 V.

Accessories supplied: one 20.3 cm (8 in.) ground lead, one retractable hook tip, and two probe tip insulating caps.

Power: supplied by instruments with probe power jacks or Model 1122A probe power supply.

Weight: net, 0.2 kg (5 oz.). Shipping, 0.91 kg (2 lb).

Length: ≈ 1.5 m (5 ft) overall.

Available accessory: 10131B 91.4 cm (36 in.) extender cable (refer to 1122A Probe Power Supply). Required for use with HP 1700 oscilloscopes with probe power option.

1122A Probe Power Supply

Model 1122A is a regulated power supply that provides all power requirements for simultaneous operation of up to four active probes.

1122A Specifications

Probe driving capability: up to four HP active probes.

Power output: -12.6 V and $+15$ V, $\pm 3\%$.

Power input: 115 V or 230 V $\pm 10\%$, 48 to 440 Hz, 40 W (with four probes).

Weight: net, 2.7 kg (6 lb). Shipping, 3.6 kg (8 lb).

Accessories supplied: four Model 10131B 91.4 cm (36 in.) extender cables.

1111A AC Current Amplifier

Deflection factor: (with a 50 mV/div oscilloscope deflection factor) in X1, 1 mA/div to 50 mA/div; in X100, 100 mA/div to 5 A/div; 1, 2, 5 sequence in X1 or X100.

Accuracy: in X1, $\pm 3\%$; in X100, $\pm 4\%$.

Rise time: 18 ns.

Noise: < 100 μ A p-p, referenced to input signal.

Maximum ac current: above 700 Hz, 50 A p-p; below 700 Hz, decreases at 1.4 A/20 Hz.

Output impedance: 50 Ω .

Size: 38.1 H x 130.2 W x 152.4 mm D (1 1/2" x 5 1/8" x 6").

Weight: net, ≈ 0.9 kg (2 lb). Shipping, 1.4 kg (3 lb).

Power: 115 or 230 V $\pm 10\%$, 50 to 440 Hz, 1.5 W.

1110B Current Probe

Sensitivity: without 100 Ω termination, 1 mV/mA; with 100 Ω termination, 0.5 mV/mA.

Accuracy: $\pm 3\%$.

Bandwidth

Lower -3 dB point: without 100 Ω termination, ≈ 1700 Hz; with 100 Ω termination, ≈ 850 Hz.

Upper -3 dB point: with 4 pF capacitive load, ≈ 45 MHz; with 30 pF capacitive load ≈ 35 MHz.

Rise time: with 4 pF capacitive load, ≈ 7 ns; with 30 pF capacitive load, ≈ 9 ns.

Insertion impedance: ≈ 0.01 Ω shunted by 1 μ H; capacitance to ground < 3 pF.

Maximum dc current: 0.5 A.

Maximum ac current: 15 A p-p above 4 kHz; decreasing below 4 kHz at 3.8 A/kHz rate.

Weight: net, 0.5 kg (1 lb). Shipping, 0.9 kg (2 lb).

Dimensions: probe aperture, 3.9 mm (3/16 in.) diameter; overall length, 1.5 m (5 ft).

Ordering Information

1122A Probe Power Supply

1124A 100 MHz Active Probe

1111A Current Amplifier

1110B Current Probe

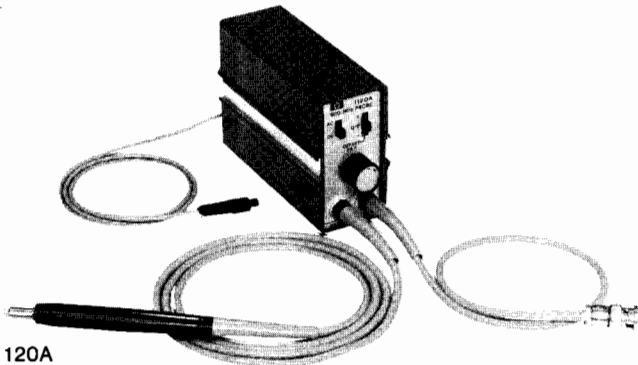

1120A

1120A 500 MHz Active Probe

For probing high source impedances at high frequencies, the Model 1120A 1:1 active probe provides a probe tip impedance of 100 k Ω shunted by approximately 3 pF at 100 MHz. When used with the 10:1 or 100:1 divider tips, the shunt capacitance is <1 pF at 100 MHz. The 50 ohm output provides the optimum impedance match and measurement accuracy for oscilloscopes, spectrum analyzers, counters, and network analyzers with 50 ohm inputs. Power is supplied by instruments with probe power jacks or the 1122A probe power supply.

1120A Specifications

(measured with output connected to a 50 Ω load.)

Bandwidth: (measured from a terminated 50 Ω source) dc-coupled, dc to >500 MHz; ac-coupled, <1.5 kHz to >500 MHz.

Pulse response: (measured from a terminated 50 Ω source) transition time, <0.75 ns; perturbations, < \pm 6% measured with 1 GHz sampler.

Dynamic range: \pm 0.5 V with \pm 5 V dc offset.

Noise: \approx 2.5 mV (measured tangentially).

Input RC: 100 k Ω , shunt capacitance \approx 3 pF at 100 MHz; with 10:1 or 100:1 dividers, shunt capacitance is <1 pF at 100 MHz.

Maximum input: \pm 80 V.

Weight: net, 1.8 kg (4 lb). Shipping, 3.2 kg (7 lb).

Power: supplied by oscilloscopes with probe power jacks or a Model 1122A probe power supply.

Length: 1.2 m (4 ft) overall; with Option 001, 1.8 m (6 ft).

Accessories Furnished

Model 10241A 10:1 divider: increases input R to \approx 1 M Ω shunted by <1 pF at 100 MHz.

Model 10243A 100:1 divider: increases input R to \approx 1 M Ω shunted by <1 pF at 100 MHz.

Model 10242A bandwidth limiter: reduces bandwidth to \approx 27 MHz shunted by \approx 6 pF and reduces gain <2%.

Also included: slip-on hook tip, 6.4 cm (2.5 in.) ground lead, spare probe tips, a slip-on BNC probe adapter.

10034A Ground Lead Kit

Model 10034A probe adapter kit consists of an assortment of 6-32 screw-on tips, and two ground lead cables which allow many methods of connecting the ground leads in a circuit. A 6-32 to slip-on adapter allows these tips to be used on 10004D-10006D, 10007B, 10008B, 10013A, 10014A, 10016B, and 1124A probes. The kit consists of one 15.2 cm (6 in.) and one 30.5 cm (12 in.) ground lead, one hook tip, one alligator tip, one pin tip, one tip for 0.6 mm (0.025 in.) square pins, one banana tip, and one slip-on to 6-32 adapter.

Ordering Information

1120A 500 MHz Active Probe

1120A Opt 001, 1.8 m (6 ft) length

10221A 50 ohm Probing Tee

10034A Ground Lead Kit

10035A Probe Tip Kit

The tips in this kit are designed to be used with probes that accept a No. 6-32 screw-on tip that include: models 10001A/B, 10002A/B, and 10003A. A slip-on to 6-32 adapter allows these tips to be used with other probes with pin tips. The adapter is supplied with 10004D through 10006D, 10014A, 10016B, 10020A probes, and 10034A ground lead kit. Model 10035A probe tip kit contains a pincer jaw, banana tip, pin tip, and spring tip.

10036B Probe Tip Kit

The tips in this kit extend the usefulness of standard probes that accept slip-on tips, and the Easy IC Miniature Probes. Included in the kit are two slip-on to 6-32 adapters and three bushing adapters that provide the flexibility to use the supplied tips with both types of probes. The adapters also allow use of other 6-32 probe tips with the probes. Model 10036B includes an assortment of tips for the following: 2.0 mm (0.08 in.) jack; 0.6 mm (0.025 in.) and 1.14 mm (0.045 in.) square pins; 1.0 mm-1.6 mm (0.040-0.062 in.) diameter pin.

10037B Probe Tip Kit

Model 10037B probe tip kit contains six 0.64 mm (0.025 in.) square female (white) tips for standard probes that accept slip-on tips, and the Easy IC Miniature Probes. Also included are six bushings that adapt HP miniature probes to the supplied tips.

Miniature Probe Accessories

10019A BNC to Square Pin Cable Assembly

Model 10019A cable assembly is designed for connecting test equipment to 0.64 mm-0.76 mm (0.025 in.-0.030 in.) square pin signal nodes or to integrated circuits through the 10024A IC Test Clip. This adaptable cable assembly is primarily used as:

a. a signal pick-off device for applying circuit signals to the input of test equipment such as oscilloscopes and voltmeters. An application is checking voltages on computer back plane pins.

b. a signal insertion cable for inserting signals into suspected faulty circuits from power supplies, pulse generators, etc. Used in conjunction with Model 10024A IC Test Clip, signals are easily inserted into the proper IC leads.

For applications requiring greater separation between the circuit nodes and the instrumentation, the 10019A may be extended by using a BNC to BNC adapter (HP P/N 1250-0080) and a 50 ohm test cable such as the 122 cm (48 in.) Model 11170C. When the test equipment hookup requires a dual banana plug, BNC to Dual Banana Plug Adapter (HP P/N 1251-2277) is available.

10017-67603 Coaxial Adapter Cable

HP P/N 10017-67603 is a 230 mm (9 in.) 50 ohm slip-on adapter cable for miniature and standard HP probes that provides a coaxial interface to 0.64 mm (0.025 in.) square pin circuit nodes. The cable is ideal for probing computer back planes as well as wire wrap terminals. HP P/N 10017-67604 miniature to standard probe adapter allows the cable to slip directly onto the HP Easy IC Miniature Probe tip with the insulating barrel removed.

10017-67604 Mini to Standard Probe Adapter

HP P/N 10017-67604 allows standard size slip-on probe tip accessories to be used with HP miniature probes. With the retractable insulating barrel removed from the miniature probe and replaced with the 10017-67604 adapter, the probe slides directly into the standard size probe tip accessories.

Ordering Information

10035A Probe Tip Kit

10036B Probe Tip Kit

10037B Probe Tip Kit

10019A Cable Assembly

10017-67603 Coaxial Adapter Cable

10017-67604 Mini to Standard Probe Adapter



OSCILLOSCOPES

Probes and Other Oscilloscope Accessories (cont.)

Miniature Probe Accessories

10024A IC Test Clip

Model 10024A IC test clip provides easy probing of dual in-line packages and includes four insulated circuit interface pins. Additional circuit interface pins are available (see Ordering Information) in packages of twelve pins. Each pin has a tip on each end so that probes such as those on HP logic analyzers can be connected for fast, functional checks of circuit operation.

10036B and 10037B Probe Tip Kits

Models 10036B and 10037B probe tip kits increase probing versatility with an assortment of 6-32 screw-on tips. Slip-on to 6-32 adapters are included for compatibility with the miniature probes.

10028A Jumper Cable

Model 10028A 50 ohm 610 mm (24 in.) miniature probe/jumper cable is designed primarily for bypassing suspected faulty circuits in densely populated IC circuits. The basic tip on either end of the cable inserts directly into a 10024A IC test clip, allowing easy temporary connections between IC's without the danger of shorting between pins. The cable can also be used as a 50 ohm 1:1 probe to insert signals from an external source or as an input source to an external measuring device. For the latter use, probe tip to BNC adapter (HP P/N 1250-1454) is available.

Digital Trigger Probes

Model 10250A (TTL) 4-bit trigger probe is a useful service, production, and design troubleshooting tool that offers digital pattern triggering to enhance the use of oscilloscopes, logic analyzers, and other test equipment. The four inputs may be switched to HI, LO, or OFF (don't care) for convenient selection of the trigger point. No separate power supply is needed because probe power is obtained from the circuit under test.

Probe Accessories

Terminations

10100C: 50 Ω \pm 1% BNC male to BNC female feedthrough termination.

10100B: 100 Ω \pm 2 Ω BNC male to BNC female feedthrough termination.

Standard Probe Tip Adapters

10011B slip-on to BNC probe tip adapter: for probes 10004D-10006D, 10007B, 10008B, 10013A, 10014A, 10016B, and 1124A.

10229A hook tip adapter: retractable pincer tip provides firm connection to circuit nodes. Supplied with 1120A probe. Recommended accessory for 10020A resistive divider kit.

HP P/N 10004-69515 IC probe tip adapter: retractable pincers provide convenient connection to dual in-line packages for probes 10004D-10006D, 10007B, 10008B, 10013A, 10014A, 10016B, and 1124A. Supplied with 10004D, 10005D, 10006D, 10014A, and 10016B.

Ordering Information

10024A IC test clip for easy probing of dual in-line packages; includes 4 insulated circuit interface pins

10024-69501 Interface Pin Kit for 10024A; includes 12 interface pins

1250-1454 BNC to probe adapter permits the miniature probes to be connected to BNC connectors to maintain fast pulse response.

10036B Probe Tip Kit

10037B Probe Tip Kit

10028A Jumper Cable

10229A Retractable Hook Tip Adapter

10004-69515 IC Probe Tip Adapter

10011B BNC Probe Tip Adapter

10100C 50 Ω Feedthrough Termination

10100B 100 Ω (\pm 2 Ω) Feedthrough Termination

Servicing and Viewing Accessories

Plug-In Extender

Model 10407B: 180 system extender (metal frame extends both plug-ins). Allows calibration while a unit is operating.

Viewing Hoods

10140A: collapsible viewing hood for 1700 series oscilloscopes.

10176A: viewing hood for 12.7 cm (5 in.) rectangular CRT bezels.

Light Filters

10173A: RFI filter and contrast screen for 1700 series oscilloscopes.

10178A: metal mesh contrast screen for 181AR oscilloscopes.

Amber plastic filter: HP P/N 5020-0530, for 12.7 cm (5 in.) rectangular CRT (180 series).

Smoke gray plastic filter: HP P/N 5020-0567, for 12.7 cm (5 in.) rectangular CRT (180 series).

Blue plastic filter: HP P/N 5060-0548, for 12.7 cm (5 in.) rectangular CRT (180 style).

Blue light filter: HP P/N 01740-02701 for 1700 series oscilloscopes.

Rack Mount Slides and Adapters

1700 Series Oscilloscopes

10491B rack mount adapter: adapts 1700 series oscilloscopes to standard 483 mm (19") rack; 222 mm (8 $\frac{3}{4}$ ") high, 540 mm (21 $\frac{1}{4}$ ") deep. Requires fixed slides (HP P/N 1490-0714) or pivoted slides (HP P/N 1490-0719) for slide mounting.

180 and 181 Rack Style Oscilloscopes

A slide adapter is required to secure an oscilloscope to the slides.

Fixed slides: HP P/N 1490-0714, 55.9 cm (22 in.).

Pivot slides: HP P/N 1490-0719, 55.9 cm (22 in.).

Slide adapter: HP P/N 1490-0768 (required for all slides).

Front Panel Covers

10166A: provides front panel protection for 180C oscilloscope.

HP P/N 5040-0516: provides front panel protection for 1700 series oscilloscopes.

Ordering Information

10407B Plug-in Extender

10116A Light Shield for 1220 series oscilloscopes

10140A Viewing Hood for 1700 series (8 x 10 div. CRT)

10166A Front Panel Cover for 180C oscilloscope

10176A Viewing Hood for 12.7 cm (5 in.) rect. CRT

10173A RFI Filter and Contrast Screen for 1700 series oscilloscopes (8 x div. CRT)

10178A Metal Mesh Contrast Screen for 181AR oscilloscopes

5020-0530 Amber Plastic Filter for 12.7 cm (5 in.) rectangular CRT

5020-0567 Smoke Gray Plastic Filter for 12.7 cm (5 in.) rectangular CRT

5060-0548 Blue Plastic Filter for 12.7 cm (5 in.) rectangular CRT

01740-02701 Blue Light Filter for 1700 series oscilloscopes (8 x 10 div. CRT)

10491B Rack Adapter for 1700 series oscilloscopes.

1490-0714 Fixed slides for 180, 181 rack style oscilloscopes and 10491B

1490-0719 Pivoted Slides for 180, 181 rack style oscilloscopes and 10491B

1490-0768 Slide Adapter, required for securing slides to 180, 181 rack style oscilloscopes

5040-0516 Front Panel Cover for 1700 series oscilloscopes.

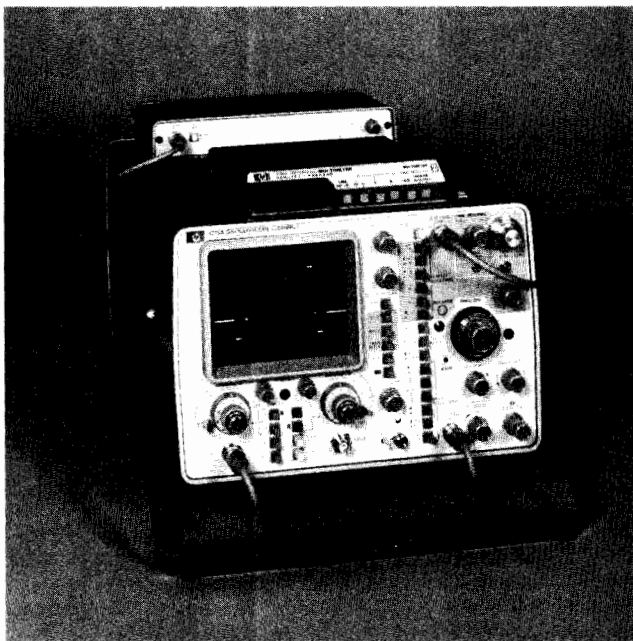

The HP 10029A TV/video sync retrofit kit can be added to any 1700 series oscilloscope except the HP 1726A for the display of composite video waveforms.

Video Sync Retrofit Kit for 17XX Series

Any 1700 series oscilloscope except the HP 1726A can easily display composite video waveforms with the addition of the HP 10029A retrofit kit module. Consisting of a user-installable module, the retrofit kit mounts on the instrument top cover. Power for the module is received from the instruments; no other internal modifications are required in the oscilloscope.

The HP 10029A module operates completely external to the oscilloscope — BNC cables provide the necessary connections. Composite video waveforms are input to the module providing a 75 ohm input for impedance matching to most video signal sources. A vertical output signal (video) provides a method for connecting the signal to the instrument's vertical input channel. With the trigger signals from the TV/video sync module and proper use of the oscilloscope's standard controls, specific portions of the composite video waveform can be selected for viewing.

Field selection is easily accomplished with one button, and a single line scan control on the module enables you to examine an individual horizontal line precisely.

Specifications

Input Impedance: 75 Ω \pm 3%. In TV clamp, ac coupled with negative clamping to ground.

Maximum Input: 75 Ω or TV clamp mode, 5 V rms.

Outputs

Main Trigger: 0.75 to <1 V square wave with main trigger slope (POS/NEG) selecting the alternate field in the frame.

Delayed Trigger: 0.75 to <1 V square wave. Delayed trigger slope selection must be set to NEG (with delayed sweep set in the "TRIG'D" mode) to engage single line scan.

TV Vertical: maintains minimum 20 MHz bandwidth.

Ordering Information

10029A TV/Video Sync Retrofit Kit

HP 10326A Time Interval Standard

The HP Model 10326A Time Interval Standard is a signal source that provides a dual-channel time interval reference. The two channels, OUTPUT and $\overline{\text{OUTPUT}}$, offer a selectable square wave output with waveform periods of 5, 10, 20, 50, or 100 nanoseconds. These output signals can be delivered to probe tips or BNC connectors with the 10326A's accessory kit.

The waveform period accuracy of any selected square wave output is \pm 5 picoseconds. This accuracy results from the purity of the crystal oscillator's frequency spectrum and the accuracy of the oscillator's frequency. Low subharmonic distortion permits short time intervals of a single period to be presented with a high degree of stability. Timing relationships between rising and falling edges in any combination are specified between output channels.

The waveform period accuracy and known timing relationships between edges of OUTPUT and $\overline{\text{OUTPUT}}$ are convenient signals to evaluate system performance. Low subharmonic distortion of output signals is ideal for calibration and other applications which require extremely stable waveforms for timing analysis.

Specifications (See data sheet No. 5953-3911 for complete details.)

Signal outputs: OUTPUT, $\overline{\text{OUTPUT}}$, Trig Out; Square Wave Period (selectable) 5 ns, 10 ns, 20 ns, 50 ns, 100 ns.

Rise Time (20–80%): OUTPUT, $\overline{\text{OUTPUT}}$ \leq 1.25 ns.

Operating Characteristics (typical values)

Square Wave Amplitude (OUTPUT, $\overline{\text{OUTPUT}}$, Trig Out) \approx 0.38 V p-p (fixed) into a 50 ohm load; warm-up time, 1 minute.

General

Weight: net, approx. 2.95 kg (6.5 lb.). Shipping, approx. 5.77 kg (12.7 lb.).

Dimensions: 9.53 mm (3.75 in.) high; 21.27 mm (8.375 in.) wide; 27.94 mm (1.1 in.) deep.

Accessories furnished: one BNC/probe adapter kit (HP P/N 10326-69501), one 2.3 m (7.5 ft.) power cord, and one operating and service manual.

Ordering Information

10326A Time Interval Standard

Option 001 - delete Accessory Kit

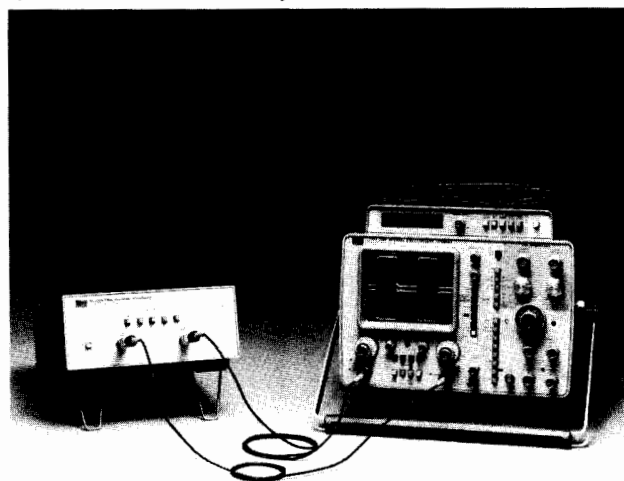

Combining the HP 1726A with the HP 10326A results in a complete solution for time interval measurement problems.

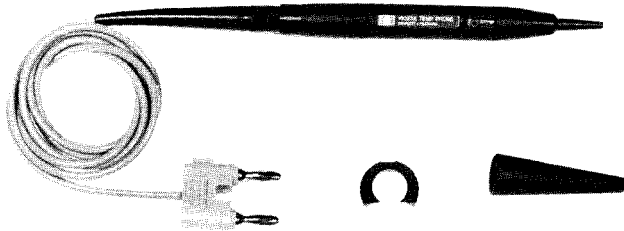

10023A

10023A Temperature Probe

The Model 10023A Temperature Probe provides fast, accurate temperature measurements in a variety of thermal design, diagnostic, and testing applications. Surface temperatures are read directly in degrees Celsius on multimeters (DMM) having an input impedance of ≥ 10 megohms. A pencil-like probe tip easily accesses small components and a press-to-read switch make measurements easy; just press the button, touch the surface to be measured, and read its temperature directly on the DMM.

The probe is a self-contained temperature-to-voltage transducer with a forward-biased diode chip bonded to a small ceramic substrate in the probe tip. A calibrated, linear output of $1 \text{ mV}/^\circ\text{C}$ is assured by individually characterizing each diode in a precision thermal reference bath. An integrated circuit resistor network is then laser trimmed to match each diode to its electronic compensation circuit.

The entire electronics assembly, including the battery, is packaged in the probe barrel. A standard dual banana plug output connector provides universal readout through most digital voltmeters including the built-in DMMs on HP's Option 034/035, 1700 Series oscilloscopes.

10023A Specifications

Electrical

Measurement range: -55°C to $+150^\circ\text{C}$.

Output: $1 \text{ mV}/^\circ\text{C}$.

Short term repeatability: $\pm 0.3^\circ\text{C}$ (minimum of 48 hrs).

Accuracy: $\pm 2^\circ\text{C}$ from 0°C to 100°C , decreasing linearly to $+2^\circ\text{C}$, -4°C at -55°C and $+4^\circ\text{C}$, -2°C at $+150^\circ\text{C}$.

Maximum voltage at tip: 600 V (dc + peak ac).

Tip capacitance to ground: approx 0.5 pF.

Thermal response: $< 3 \text{ s}$ to settle within 2°C of final reading (liquid measurement) for a 100°C temperature change.

DMM Input R: $\geq 10 \text{ M}\Omega$.

General

Operating environment probe tip to approx 13 mm (0.5 in.) from probe tip: temperature, -55°C to $+150^\circ\text{C}$; altitude, to 4600 m (15,000 ft); vibration, vibrated in three planes for 15 min. each with 0.38 mm (0.015 in.) excursion, 10 to 55 Hz.

Operating environment (probe body): temperature, 0°C to 60°C (battery limitation); humidity (non-condensing), to 95% relative humidity at $+40^\circ\text{C}$, altitude and vibration same as those for probe tip.

Overall length: approx 1.4 m (53 in.).

Weight: net, 85 g (3 oz). Shipping, 312 g (11 oz).

Battery life: approx 50 hr (varies with ambient temperature).

Low battery indication: probe output indicates approx -70°C on DMM. First indication of a low battery condition is a decreasing indication of 1° to $2^\circ\text{C}/\text{minute}$ with probe tip at a constant temperature.

Accessories supplied: one replacement battery (1420-0256), one sliding lock collar (10023-23201), and one probe tip cover (00547-40005).

Replacement batteries: batteries may be purchased locally using the following part numbers, RAY-O-VAC^{®1}, RS 312-G or T-312-G; DURACELL^{®2} 10L125; or batteries with similar specifications.

^{®1}RAY-O-VAC is a registered trademark of ESB, Inc.

^{®2}DURACELL is a registered trademark of P. R. Mallory & CO.

Ordering Information

10023A Temperature Probe

10023-60001 Replacement Tip, includes pre-calibrated tip and matching compensation network

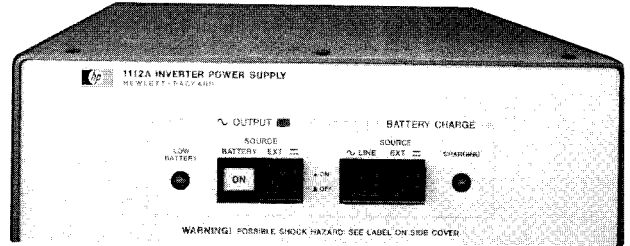

1112A Inverter Power Supply Specifications

Output

Voltage: 120 or 240 V ac, peak-to-peak output is fixed at 285 V; rms value changes with load; minimum usable load, 20 W.

Load	120 V Range		240 V Range	
	400 Hz	60 Hz*	400 Hz	60 Hz*
65 W	$\geq 96 \text{ V rms}$	$\geq 99 \text{ V rms}$	$\geq 192 \text{ V rms}$	$\geq 198 \text{ V rms}$
20 W	$\leq 126 \text{ V rms}$	$\leq 126 \text{ V rms}$	$\leq 250 \text{ V rms}$	$\leq 250 \text{ V rms}$

*With Option 060

Waveform: duty cycle is 50% for loads of 40 W, increasing to 65% as the load decreases to 20 W.

Frequency: $400 \text{ Hz} \pm 10\%$ (Opt 060, $60 \text{ Hz} \pm 0.5 \text{ Hz}$).

Max power: 65 W nominal, compatible with line voltage and 60 to 70 VA load requirements of HP 1700 series oscilloscopes.

Operating time: ≈ 140 watt hours with a fully charged battery pack at 25°C .

Input power: external dc source; 11.5 V to 50 V (Opt 060, 12 V to 50 V), at least 90 watts; External ac source; 100 V to 120 V or 220 V to 240 V, $+5\%$, -10% ; 48 to 66 Hz; 250 VA max; ac feedthrough operation; output voltage and frequency is the same as the input; output power, 120 VA max.

Battery charging: ac input; full charge in 14 hrs at $+25^\circ\text{C}$ with 120 V rms input (80% in 8 hrs); dc input: full charge in 24 hrs at $+25^\circ\text{C}$ with 18 watts input.

General

Size: 92 H x 273 W x 403 mm D ($3\frac{5}{8}$ " x $10\frac{3}{4}$ " x 15 $\frac{3}{4}$ ").

Weight: net, 9.1 kg (20 lb) with battery pack, 4.5 kg (10 lb) without battery pack; shipping, 10. kg (22 lb) with battery pack, 5.4 kg (12 lb) without battery pack.

Compatibility: HP 1700 series oscilloscopes. For compatibility with other instruments, call your HP Field Engineer.

Operating environment: temperature, 0 to $+55^\circ\text{C}$ ($+32^\circ\text{F}$ to $+130^\circ\text{F}$), non-operating -40°C to $+55^\circ\text{C}$ (-40°F to $+130^\circ\text{F}$); humidity, to 95% relative humidity at $+40^\circ\text{C}$ ($+104^\circ\text{F}$); altitude, to 4600 m (15,000 ft); vibration, vibrated in three planes for 15 min. each with 0.38 mm (0.015 in.) excursion, 10 to 55 Hz.

Accessories supplied: one Model 10421A battery pack, one mounting bracket kit, one 2.3 m (7.5 ft) power cord, one 2.1 m (7 ft) grounding cable, and one operating and service manual.

1112A Accessories

10421A Battery pack: the battery pack consists of 30 size D nickel cadmium cells and includes temperature sensors to reduce the possibility of cell damage during charging (supplied with 1112A).

Weight: net, 4.4 kg (10 $\frac{3}{4}$ lb). Shipping, 5.3 kg (11 $\frac{3}{4}$ lb).

01112-61605 Grounding Cable: grounds inverter and oscilloscope chassis (supplied with 1112A).

01112-69501 Mounting Bracket Kit: for mounting the 1112A on top or bottom of 1700 series oscilloscopes (supplied with 1112A).

Ordering Information

1112A Inverter power supply (400 Hz)

Opt 001: without battery pack

Opt 002: without mounting bracket kit

Opt 060: 60 Hz output frequency, internal battery operation reduced to 120 watt hours

10421A Battery pack

01112-61605 Grounding cable

01112-69501 Mounting bracket kit

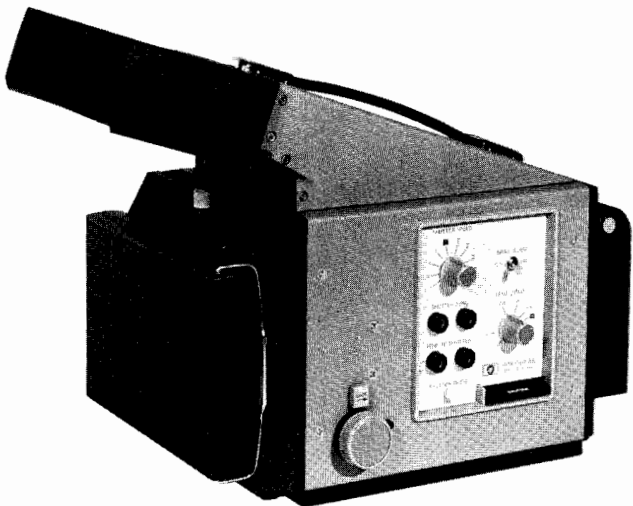

Model 197B is a versatile, general purpose instrument for cathode-ray tube photographic recording. The camera features lift-off mounting and swing-away hinging by pressing a single latch release button. Interchangeable film backs enable capture of CRT display information on a complete spectrum of Polaroid® or conventional sheet, pack, or roll film. All controls are located outside of the camera for easy reading and fast adjustment during setup. A low-angle viewing port provides a direct view of the display through a flexible facemask while the camera is in the photographic position.

A combination split-image focusing plate and image reduction ratio scale is included and is stored in a convenient pocket underneath the camera. The reduction ratio scale provides 1:1, 1:0.9, and 1:0.7 reference settings for displays with one centimetre graticule spacing. Corner marks on the focusing plate allow the usable film area to be accurately identified. The optional Graflok® back is equipped with a ground glass focusing plate and a snap-out viewing hood.

Model 197B camera incorporates an electronically controlled shutter with eight exposure times from 1/30 to 4 seconds. Time (T) and bulb (B) control settings are also provided. The camera lens opening is continuously adjustable from $f/1.9$ to $f/16$. The 75 mm, high transmission lens provides high resolution, low distortion photographs for capturing a wide range of images.

Camera Mounting

On initial order, the 197B can be configured, with different camera adapters, to mount directly on a variety of instruments as listed in the 197B Camera Compatibility Table. Each camera adapter is attached to the camera body with a piano hinge and is an integral part of the camera. Model 197B includes a 10376A adapter that directly interfaces to HP 1700 series oscilloscopes with 8 x 10 division CRTs. Model 197B Option 002 includes a 10378A adapter that directly interfaces to HP 180 series oscilloscopes. Model 197B Option 006 includes a 10375A adapter which directly interfaces with the majority of HP small screen CRT displays.

By using camera bezel adapters, various camera configurations can be adapted to other instruments not directly compatible with the camera adapter. For mounting a variety of cameras to instruments both current and those no longer in production, refer to the 197B Camera Data Sheet. Copies of the 197B Data Sheet can be obtained from your local HP field office or by writing: Inquires Manager, Hewlett-Packard Company, 1820 Embarcadero Road, Palo Alto, California 94303.

197B Characteristics

Reduction ratio: continuously adjustable from 1:1 to 1:0.7. Reference scale provided on focus plate.

Lens: 75 mm, $f/1.9$ high transmission lens; aperture, $f/1.9$ to $f/16$.

*Registered Trademark of Polaroid, Inc.

*Registered Trademark of Graftek, Inc.

197B Camera Compatibility				
Instrument	197B	Opt 002	Opt 006	Opt 009
Oscilloscopes				
1740/41/42/43/44, 1726	X			
1745A/46A				X
1715A/22B/25A/27A	X			
180/181		X		
1980 System			X	
Displays				
1332/33/35/36/40/45/46/47			X (3)	
Network Analyzers				
8412A		X (4)		
8414A		X		
8505A			X (3)	
8754A		(1)		
Signal Analyzers				
140T/180TR		X (2)		
141T/181T/TR		X		
182T		Add 10367A (2)		
3580A		X		
3582A/85A			X (3)	
3720A/21A		X		
5420A/23A			X (3)	
8565A/66A/68A			X (3)	

Notes:

1. Model 8754A CRT has P39 phosphor. Ultraviolet light does not excite P39 phosphor and will not illuminate an internal graticule. However, the 197B Opt 002 physically fits on the 8754A.

2. These instruments have P39 phosphor with internal graticule illumination supplied by internal CRT floodguns.

3. These instruments have Lexan CRT faceplates that attenuate ultraviolet light and will not allow illumination of an internal graticule. Instruments with internal floodguns provide internal graticule illumination.

4. Model 8412A CRT has P7 phosphor and the ultraviolet camera light source does not illuminate the phosphor very well, and there is no internal CRT floodgun for graticule illumination.

Shutter speeds: 1/30, 1/15, 1/8, 1/4, 1/2, 1, 2, 4 seconds, Time and Bulb; shutter has a sync contact closure output for triggering external equipment and an input jack for remote operation.

Camera back: 83 mm x 108 mm (3.25" x 4.25") Polaroid® pack back (Graflok® back is available, see Options).

Mounting: lift on/off mounting with positive lock, swing-away hinging to left.

Viewing: low-angle, direct viewing through a flexible facemask.

Shutter open indicator: illuminated whenever shutter is open.

Ultraviolet illumination: light source and lens filter provide graticule illumination and photographic speed enhancement.

Focus: adjustable with lock; split-image focusing plate provided.

Size: 267 H x 194 W x 356 mm D (10.5" x 7.6" x 14").

Weight: net, 4.5 kg (10 lb). Shipping, 7.3 kg (16 lb).

Power: switch selectable 115 Vac $\pm 10\%$ or 230 Vac $\pm 10\%$, 48 to 66 Hz*, 10 VA max.

Accessories furnished: comb. split image focusing plate reduction ratio scale, 2.3 m (7.5 ft) power cord, and instruction manual.

Ordering Information

197B Camera

001: deletes ultraviolet illumination feature

002: replaces 197B adapter with 10378A adapter.

003: Graflok® back in place of pack back

006: replaces 197B adapter with 10375A adapter.

007: meets UL listing requirements for medical and dental electronic equipment.

009: Camera Bezel Adapter for 1745A and 1746A oscilloscopes.

910: additional manual

10367A Camera Bezel Adapter for 182T

Ultraviolet Light Kit (P/N 00197-69507) for field installation of ultraviolet illumination feature.

*Camera operates from 48 to 440 Hz, but does not meet the ac line to chassis leakage requirements of UL 544 listing above 66 Hz.

OSCILLOSCOPES

Testmobiles: Save Bench Space, Easily Moved

Models 1006A, 1007A, 1008A & 1117B

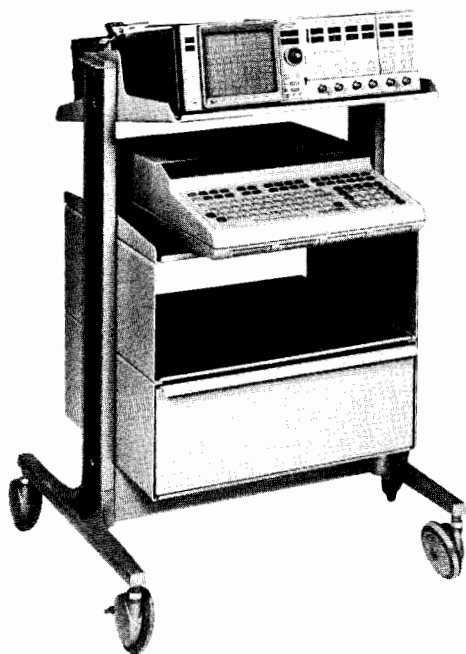

1008A Opt 006

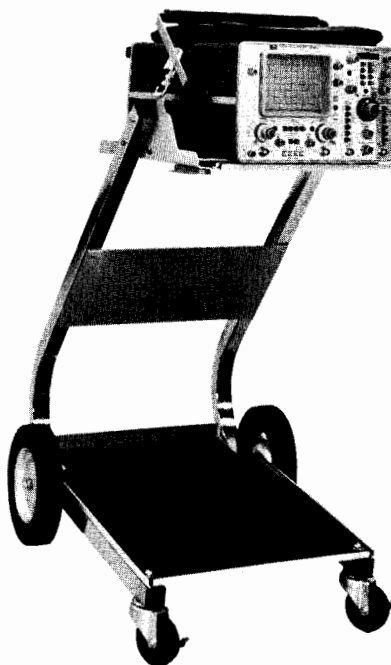

1006A

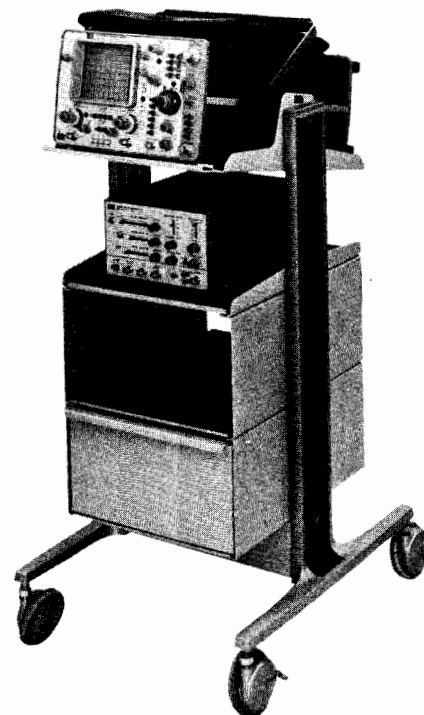

1007A Opt 006

Hewlett-Packard testmobiles offer convenient portability for your oscilloscopes or instrumentation systems. The top tray on these testmobiles may be tilted to position your instrument for easy operation. The selection of testmobiles range from a basic model such as the 1006A, designed to hold a single oscilloscope or other instrument, to a testmobile such as the 1008A or 1117B that can be adapted to provide a complete mobile test system. Refer to the testmobile/instrument compatibility chart for assistance in selecting the testmobile that will best fit your requirements.

1007A, 1008A Description

These versatile testmobiles provide a sturdy, lightweight, stable platform for your oscilloscope or instrumentation system (see compatibility chart). Large angled wheels with a wide track move quietly and smoothly over most surfaces. The top trays are table-top height and can be tilted to a convenient viewing angle between 30° above and 30° below the horizontal position with a total of seven detent positions in 10° increments. The caps on each side rail are designed to hold three probes conveniently to reduce the possibility of damaging probes not in use.

Testmobile/Instrument Compatibility

Testmobile Model Number	Instrument
1006A 1007A	All Hewlett-Packard 180, 1200, 1220, and 1700 series cabinet style oscilloscopes, or other instruments that meet the height and weight requirements.
1008A	Hewlett-Packard instruments that are configured to be mounted in a standard 48.3 cm (19 in.) rack and meet the testmobile height and weight requirements, such as the 1980B.
1117B	All instruments listed above.

1007A, 1008A Options

Many options are available so that the 1007A or 1008A can be easily tailored to your specific requirements. Refer to the option photographs with description to select the testmobile best suited to your requirements. Options apply to both the 1007A and 1008A. Option 008, U.S.-only five outlet power strip, is also available for convenient instrument operation.



1006A

1006A Description

This is a sturdy general purpose testmobile for cabinet style oscilloscopes and other instruments (see compatibility chart). The tilt tray adjusts $\pm 30^\circ$ in 10° increments. A base tray and an accessory rack add space for other instruments and accessories; and a convenient bracket holds three HP probes. Large rear wheels allow easy movement and locking front casters hold the testmobile in position. A five outlet power strip accessory is available for mounting under the tilt tray or beneath the accessory rack.

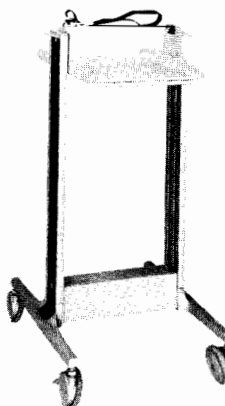

Basic Testmobile

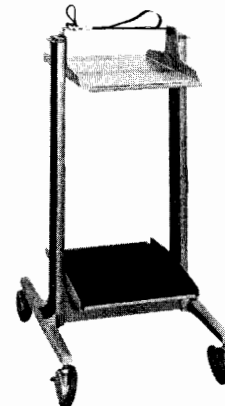

Opt 001: storage shelf
load limit: 18 kg (40 lb).

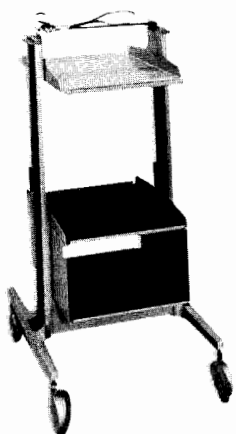

Opt 002: storage shelf and lower cabinet; load limit 18 kg (40 lb) each.

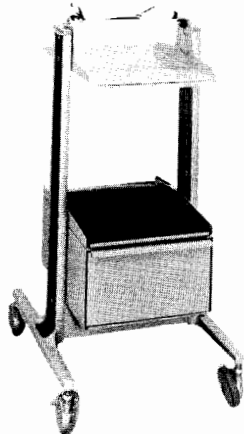

Opt 003: 15 cm (6 in.) lockable drawer with shelf on top; load limit 11 kg (25 lb) in drawer and 18 kg (40 lb) on shelf.



1117B

1117B Description

Model 1117B provides a mobile test station for cabinet and rack model instruments, with tilt tray angles from -15° to $+30^{\circ}$ in $7\frac{1}{2}^{\circ}$ increments for easy viewing. In addition, other instruments can be mounted in the standard EIA racks of the lower compartment. Rack mounting height is 62.2 cm (24½ in.), depth is 58.4 cm (23 in.), and power distribution is provided with a built-in four outlet power strip. Optional accessory drawers 7.6 cm (3 in.) and 20.3 cm (8 in.) deep are available to provide convenient storage space. The drawers may be installed in many vertical positions of the lower compartment, allowing room for other rack mounted equipment.

Specifications

(see Testmobile data sheet for complete specifications)

	1006A	1007A	1008A	1117B
Height	841 mm (33¼ in.)	930 mm (36½ in.)	930 mm (36½ in.)	1003 mm (39½ in.)
Overall width	502 mm (19¾ in.)	584 mm (23 in.)	759 mm (29¾ in.)	511 mm (20¼ in.)
Width of tray	322 mm (12⅞ in.)	321 mm (12⅞ in.)	473 mm (18½ in.)	
Tilt tray angle	$\pm 30^{\circ}$	$\pm 30^{\circ}$	$\pm 30^{\circ}$	-15° to $+30^{\circ}$
Weight	net	11.8 kg (26 lb)	11 kg (25 lb)	13 kg (28 lb)
	shipping	14.5 kg (32 lb)	19 kg (41 lb)	22 kg (48 lb)
Max load on tilt tray	23 kg (50 lb)	34 kg (75 lb)	45 kg (100 lb)	45 kg (100 lb)
Max load below tilt tray	23 kg (50 lb)	see Option descriptions	see Option descriptions	56.7 kg (125 lb)

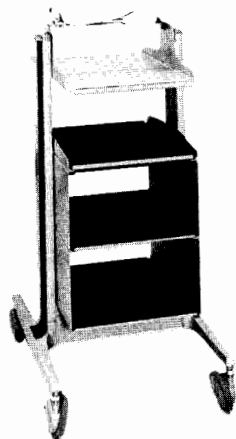

Opt 004: two storage cabinets with shelf on top; combined load limit, cabinets and shelf, 45 kg (100 lb).

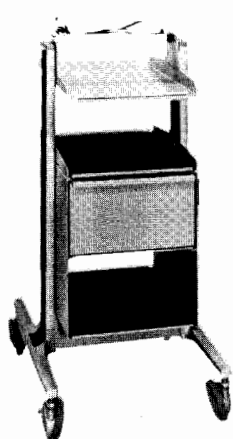

Opt 005: storage cabinet and drawer in upper position with shelf on top; load limit 18 kg (40 lb) each on shelf and in cabinet, 11 kg (25 lb) in drawer.

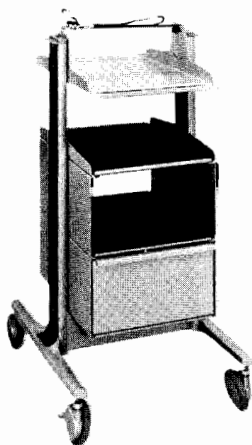

Opt 006: storage cabinet with shelf on top and drawer in lower position; load limit 18 kg (40 lb) each on shelf and in cabinet, 11 kg (25 lb) in drawer.

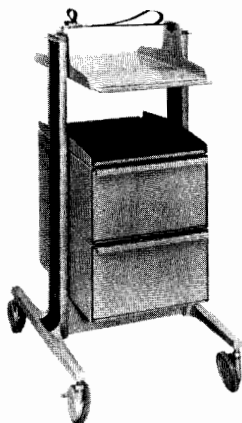

Opt 007: two lockable drawers with shelf on top; load limit 18 kg (40 lb) on shelf, 11 kg (25 lb) each drawer.

Optional Accessories

- 10475A** 7.6 cm (3 in.) drawer for 1117B testmobile
Weight: net, 4.1 kg (9 lb); shipping, 5.9 kg (13 lb).
- 10476A:** 20.3 cm (8 in.) drawer for 1117B testmobile
Weight: net, 5.4 kg (11 lb); shipping, 8.2 kg (18 lb).
- 01008-61201** Probe Pod Holder holds three small Logic Analyzer probe pods such as 10230 and 10248
- 01008-61202** Probe Pod Holder holds one small and one large Logic Analyzer probe for 1611A
- 01008-68701** Rack Mount Kit for 1008A, 13.3 cm (5¼ in.) high for mounting under the tilt tray
- 01008-68702** Rack Mount Kit for 1008A, 19 cm (7½ in.) high for mounting under the tilt tray
- 01007-60008** Power Strip kit adds Opt 008 power strip to all versions of 1006A, 1007A, 1008A testmobiles

Ordering Information

- 1006A Testmobile**
- Opt 008** Power Strip
- 1007A, 1008A Testmobiles**
(see 1007A, 1008A Options for option descriptions)
- Opt 001:** storage shelf
- Opt 002:** storage shelf, lower cabinet
- Opt 003:** storage shelf, locking drawer
- Opt 004:** two storage cabinets, shelf
- Opt 005:** upper drawer, lower storage
- Opt 006:** lower drawer, upper storage
- Opt 007:** two locking drawers
- Opt 008:** power strip (5 outlet)

1117B Testmobile (includes power strip)



Selecting a graphics display is no longer a simple choice between an electrostatic or an electromagnetic cathode-ray tube (CRT). The trend to microcomputer and minicomputer control of instruments and systems is generating needs to display more complex pictures. Reduced memory costs are making it possible to design a greater variety of digital displays using either electrostatic or electromagnetic CRTs.

Electrostatic CRT

The heart of HP graphics displays is an electrostatic CRT. Also included are X- and Y-axes deflection amplifiers, a Z-axis (video) amplifier, and both high and low voltage power supplies. HP small screen displays are available with or without cabinets. In addition, several rack and bench type cabinet configurations are available, giving your designer a high degree of flexibility in incorporating HP displays into your instrument or system.

The primary attributes of the electrostatic CRT are high writing speed and low power requirements. The deflection plates are voltage driven whereas electromagnetic CRTs are current driven, through a yoke and tuned circuit in raster-scan displays. Vector writing speeds of electrostatic CRT displays are typically ten times faster than high-performance electromagnetic CRT displays.

Power requirements become a significant

consideration with large screen displays. All HP large screen displays meet environmental specifications without a fan. The maximum power of any HP display is 185 watts. This can be a benefit in reducing system cooling requirements.

Digital Interfaces

Model 1351A Graphics Generator provides a convenient digital interface between computers and controllers and the analog inputs in the majority of HP graphic displays. Model 1351A converts digital inputs to analog outputs capable of driving HP's large screen displays. The very high resolution of these displays, combined with the 1351A's 8k vector/character generating capability, provide the complex drawing capability needed in computer aided graphics systems such as CAD/CAM.

Model 1345A is a high performance display that has a built-in digital interface and it is ideal for microprocessor-based instrumentation and system applications. The 1345A represents a new concept in instrumentation displays with its 16-bit TTL I/O. The advantage of the 16-bit I/O is that digital interfacing to a microprocessor based system provides a convenient, high performance interface. With the many peripheral interfacing adapters (PIAs) that are available, interfacing a digital system to the 1345A can be accomplished in a fraction of the time re-

quired for interfacing displays with analog inputs. The 16-bit I/O also operates with 8- or 16-bit microprocessors which assures compatibility with present and future instrument systems.

The 1346A Digital Display Module is well-suited for applications using an HP-IB/IEEE-488 internal configuration. This interface simplifies integrating the 1346A into instruments that do need the speed of the 1345A's 16-bit binary interface.

The 1347A HP-IB Display is designed for applications needing a peripheral small-screen display. This self-contained display's interface is HP-IB using HP-GL (HP Graphics Language), and it can copy its screen or memory contents to an HP-IB/HP-GL plotter. In addition, the 1347A's data-scrolling capability make it useful in data-acquisition and monitoring applications.

Imaging Applications

HP CRT displays have been used to present continuous-tone images both for direct viewing and photographic recording for many years. One of the first applications was to produce high-speed, random dot images from gamma cameras used in nuclear medicine. HP's advanced technology makes it possible to manufacture CRTs with highly uniform light output which is essential in assuring the diagnostic accuracy of gamma camera pictures.

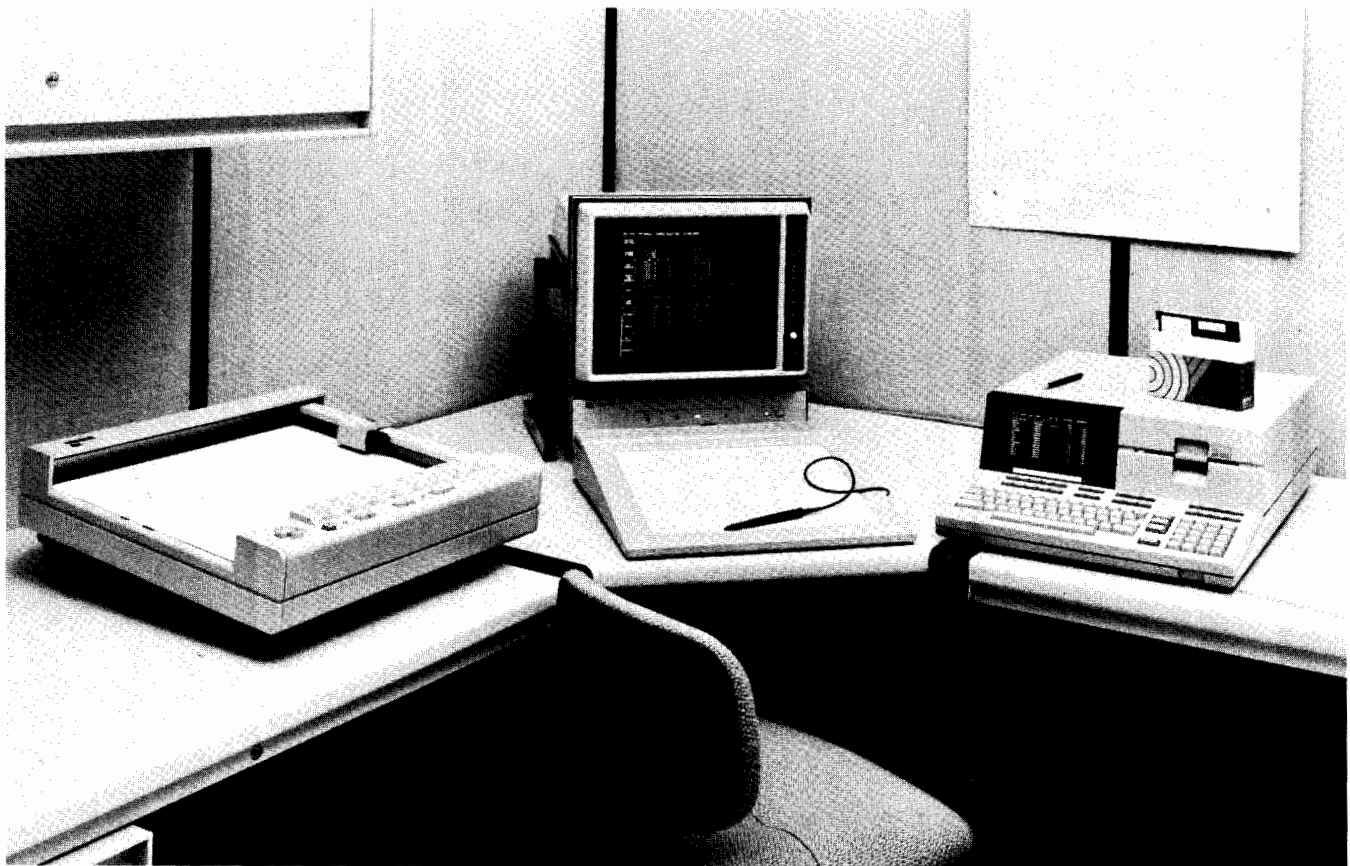

Measurement Instruments

Most measurement instruments that produce line drawing pictures operate in real-time. Because of the need for high writing speed they usually include an electrostatic CRT display. The HP Model 1340A and 1345A meet the needs of measurement instrument designers. The modular package makes them physically easy to incorporate into an instrument or system. Integrated circuit amplifiers provide flexibility when electrically integrating the 1340A with an instrument. DC voltage levels control X and Y amplifier gain and position as well as intensity. Either controls supplied with the 1340A or circuits in your instrument can be used to control the display. The 1345A/1346A have digital interfaces, making them ideally suited to digitally controlled systems. CRT performance meets the picture drawing needs of both analog and digitally controlled instruments.

Measurement Systems

The capability of the 1351S to update a portion of the picture without redrawing the entire display is extremely useful in measurement systems.

Radar and sonar system designers can benefit from the speed and versatility of HP graphics display systems. Most of these sys-

tems display continually changing pictures which the operator uses to make tactical decisions. He cannot afford to wait a significant length of time for pictures to be updated. Consequently, the high refresh rate of the 1351A and the high speed and resolution of HP's large screen displays make them good choices for such applications.

Analytical chemistry systems often need large screen, high resolution pictures to display various spectra. The 1351S and its 1020 x 1020 addressable resolution is an excellent match for analytical instrument specifications. Its memory versatility enables the system operator to store several spectra and quickly display various sequences of data for comparative analysis. All this can be done at ambient light levels because of the brightness of the 1351S Display System.

Some medical research and data acquisition systems require simultaneous display of several traces. It is possible to continuously update HP large screen displays through the 1351A Graphics Generator to simulate a multiple-trace chart recorder. Simulation systems usually operate in a real-time mode and require fast picture writing speeds. The 1351S is being used in several simulation systems because it can display changes in the picture at rates faster than operator response times. Other benefits for simulation systems

are the capability to operate multiple displays and to use a variety of CRT sizes.

Computer Graphics

Computer graphics is one of the most rapidly growing branches in the computer field. Graphics is an extremely effective medium for communication between human and computer; the eye is able to absorb information in graphical form much faster than it can interpret information in tabular form.

Large-screen displays are well-suited to computer graphics applications, particularly in the areas of computer-aided design (CAD) and computer-aided manufacturing (CAM). Many CAD/CAM systems use interactivity, which allows the operator to draw and manipulate objects or elements by means of an input device like a tablet or light pen. The result of the action is seen in real-time on the display screen. To the user it appears that the picture is changing instantaneously in response to his commands.

Product Guide

Softcopy Graphics217
 Instrumentation Graphics System218
 Displays for Computer Graphics219
 Instrumentation Digital Displays220
 Instrumentation Analog Displays222
 Imaging Displays223



GRAPHICS DISPLAYS

Product Selection Guide

Small-Screen Analog Displays

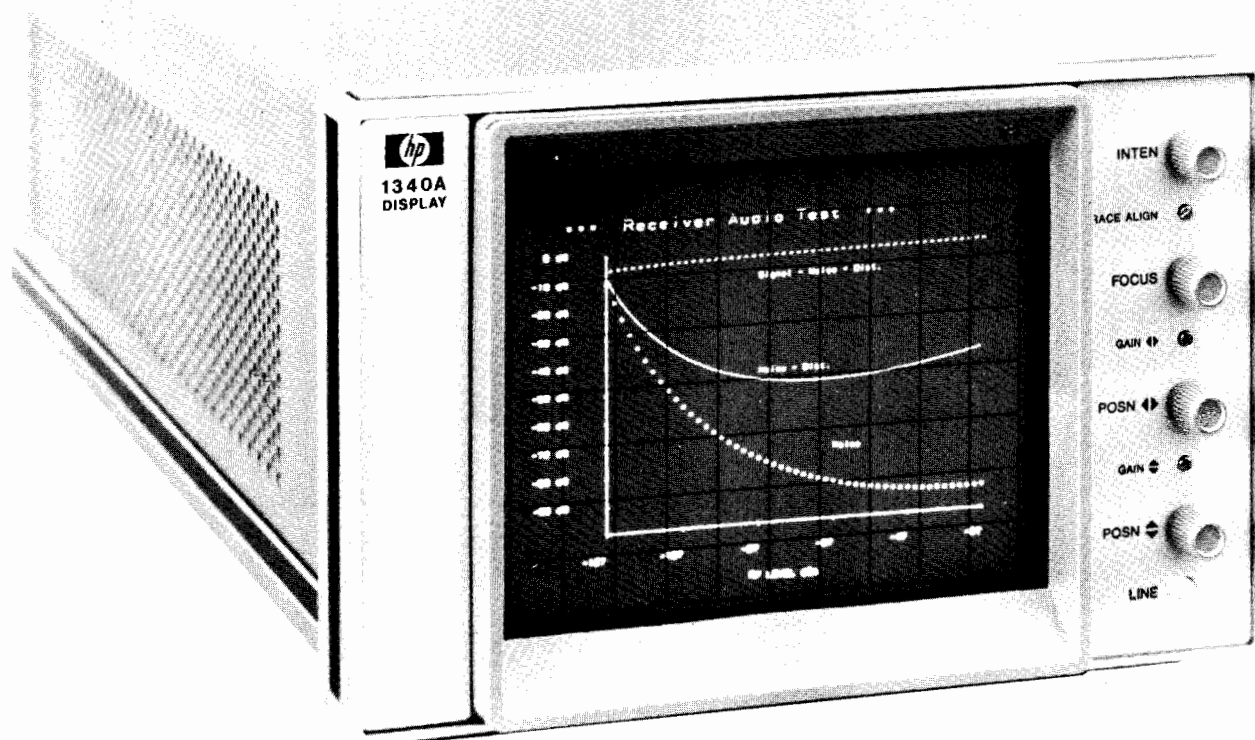

1340A with Option 315 half-rack cabinet

Features	Model Number				
	1332A	1335A (conventional)	1335A (storage)	1336A	1340A
Spot Size	≤0.30 mm	≤0.25 mm	≤0.50 mm	≤0.07 mm	≤0.46 mm
Resolution	31.5 lines/cm (80 lines/in)	39 lines/cm (99 lines/in)	20 lines/cm (51 lines/in)	140 lines/cm (356 lines/in) center screen	22 lines/cm (55 lines/in)
Settling Time	≤300 ns	≤300 ns	≤300 ns	≤500 ns	≤300 ns
Linearity	3%	3%	3%	3%	3%
Viewing Area	≈ 9.6 x 11.9 cm (3.8 x 4.7 in)	≈ 7.1 x 9 cm (2.8 x 3.6 in)	≈ 7.9 x 9 cm (2.8 x 3.6 in)	≈ 8 x 10 cm (3.2 x 3.9 cm)	≈ 9.6 x 11.9 cm (3.8 x 4.7 in)

Note: these are condensed specifications; refer to applicable data sheet for complete specifications, including options and accessories.

Common Specifications

Operating Environment

Temperature: 0°C to +55°C (+32°F to +131°F), operating; -40°C to +70°C (-40°F to +158°F), non-operating.

Humidity: to 95% RH at +40°C (+104°F).

Altitude: to 4600 m (15 000 ft), operating; to 6300 m (20 669 ft), non-operating.

Shock: 30 g peak, ½ sine wave, 11 ms duration.

Vibration: 15 min. in each plane at 0.38 (0.015 in.) mm p-p excursion, 5–55 Hz, 1 min./octave, 10 min. at each resonant frequency (except 1332A, 1335A: 15 min. in each plane, 0.25 mm (0.010 in.) p-p excursion, 10–55 Hz).

Primary line voltage: 100, 120, 220, or 240 Vac, +5%, -10% (1336S: +5%, -20%).

Ordering Information

1332A Small Screen Display

1335A Small Screen Display

1336A Display Module

1336P Power Supply Module

1336S Display System (includes 1336A, 1336P)

1340A Display Module (with control panel)

OEM and quantity discounts available.

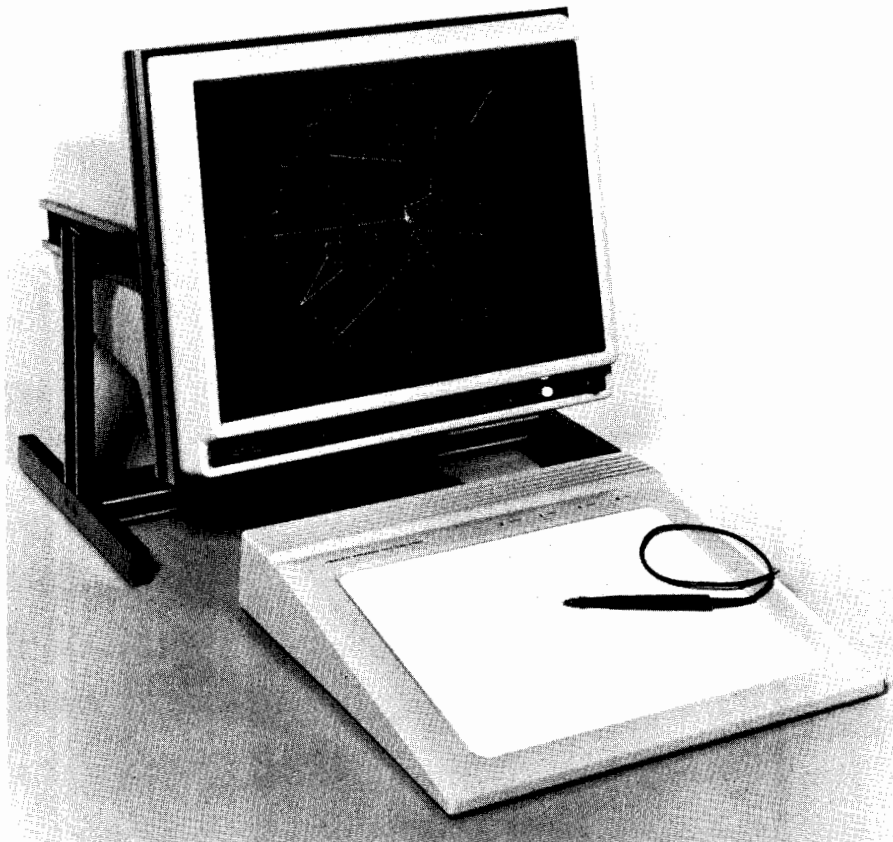

Features	Model Number				
	1304A	1310B	1311B	1317B	1321B
Viewing Area	≈ 20 x 25 cm (7.9 x 9.8 in)	≈ 28 x 38 cm (11 x 15 in)	≈ 21.6 x 27.9 cm (8.5 x 11 in)	25.4 x 34.5 cm (10 x 13.5 in)	43.2 x 30.5 cm (17 x 12 in)
Resolution	≤20 lines/cm (50 lines/in)	≤20 lines/cm (50 lines/in) center screen ≥14 lines/cm (36 lines/in) corner	≤24 lines/cm (61 lines/in) center screen ≥20 lines/cm (51 lines/in) corner	≤19.7 lines/cm (50 lines/in) center screen ≥13 lines/cm (33 lines/in) corner	≤20 lines/cm (51 lines/in) center screen ≥14 lines/cm (36 lines/in) corner
Spot Size	0.02 in	≤0.51 mm (0.02 in) center screen ≤0.70 mm (0.0275 in) corner	≤0.43 mm (0.017 in) center screen ≤0.51 mm (0.02 in) corner	≤0.51 mm (0.02 in) center screen ≤0.76 mm (0.03 in) corner	≤0.51 mm (0.02 in) center screen ≤0.70 mm (0.0275 in) corner
Linearity	≤3%	≤1%	≤1%	1≤%	≤1%
Settling Time	≤300 ns	≤500 ns	≤500 ns	≤500 ns	≤500 ns

Note: these are condensed specifications; refer to applicable data sheet for complete specifications, including options and accessories.

Common Specifications

Operating Environment

Temperature: 0°C to 55°C (+32°F to +131°F), operating; -40°C to +70°C (-40°F to +158°F), non-operating.

Humidity: to 95% RH at +40°C (+104°F).

Altitude: to 4600 m (15 000 ft), operating; to 7600 m (25 000 ft), non-operating (15 300 m, 50 197 ft for 1304A).

Vibration: 15 min. in each plane, 0.25 mm (0.010 in.) p-p excursions (0.38 mm, 0.015 in. for 1304A, 1338A), 5 to 55 Hz; 1 min./octave, 10 min. at each resonant frequency.

Ordering Information

***1304A** 32 cm (14 in) Display

1310B 48 cm (19 in) Display

1311B 36 cm (14 in) Display

1317B 43 cm (17 in) Display

1321B 53 cm (21 in) Display

*Not recommended for high speed, high resolution computer graphics applications.

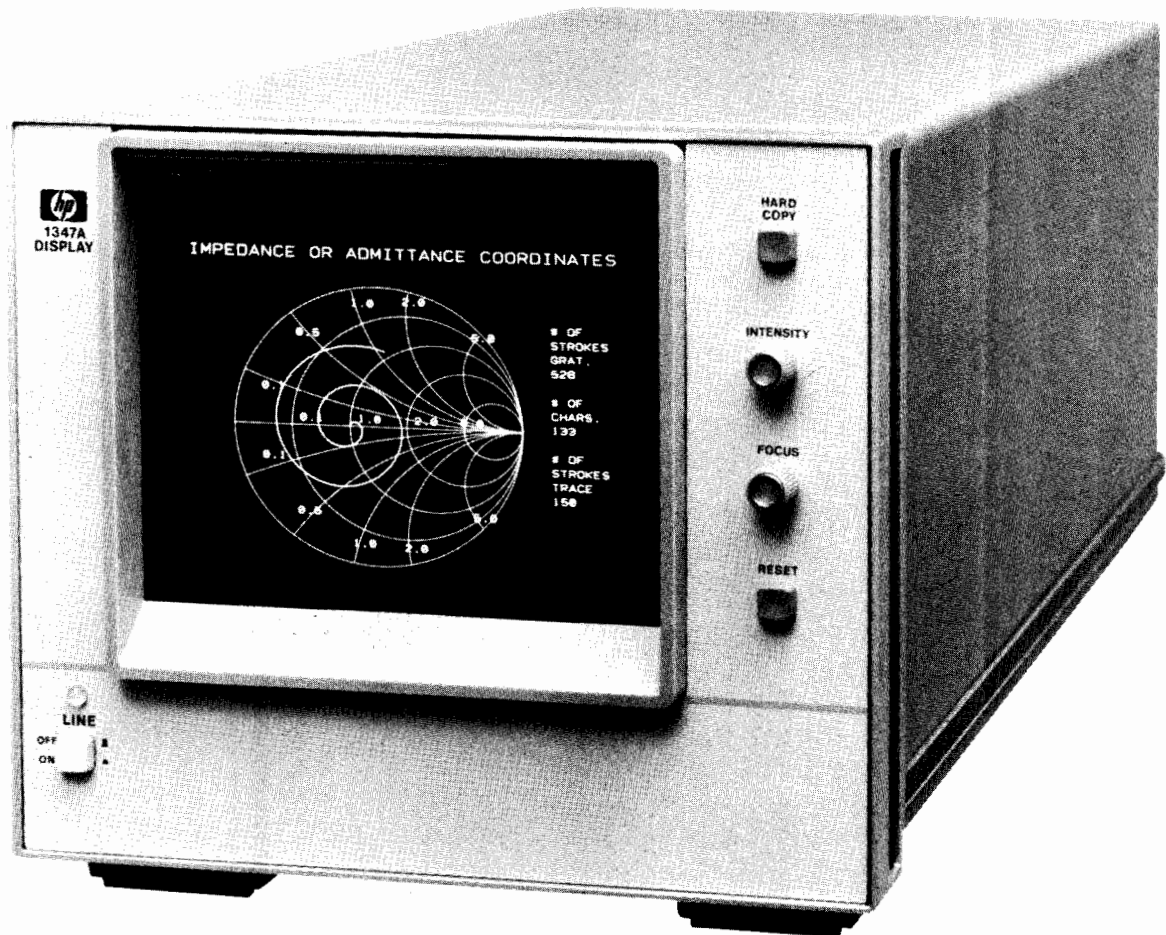

Features	Model Number			
	1345A	1346A	1347A	1351A
Interface	16-Bit TTL	HP-IB	HP-IB	HP-IB 16-Bit Binary (Opt 002) RS-232C (Opt 001)
Viewing Area	12.5 x 9.6 cm (31.75 x 24.4 in)	Same as 1345A	Same as 1345A	N/A
Addressable Resolution	0-2047X 0-2047Y	0-2047X 0-1512Y	0-2047X 0-1512Y	0-1020X 0-1020Y
OEM Module w/o Power Supply	Yes	Yes	No	No
Fully Self-Contained Peripheral	No	No	Yes	Yes

Note: These are condensed specifications; refer to applicable data sheet for complete specifications, including options and accessories.

Common Specifications

Operating Environment

Temperature: 0°C to +55°C (65°C for 1345A) operating; -40°C to +70°C non operating.

Humidity: to 95% relative humidity at +40°C (50°C for 1345).

Altitude: to 4600 m operating; 7600 m (15 300 m for 1345A) non-operating.

Ordering information

1345A Digital Display

1346A Digital Display Module

1347A HP-IB Display

1351A Graphics Generator



Choice of Interface

Several HP displays and display systems give the user a choice of three interfaces: HP-IB, RS-232C, and 16-bit parallel. The HP 1351A Graphics Generator can take digital information from one of the three interfaces mentioned above and change it to X, Y, and Z analog voltages necessary to drive HP large screen displays. In addition, the 1345A Digital Display Module can accept commands via 16-bit parallel and is suited for OEM instrumentation graphics.

Applications

- Schematic generation
- Engineering design and evaluation (mechanical, electrical, chemical, etc.)
- Radar/sonar control/monitoring
- Real-time instrumentation systems (data acquisition/analysis, production testing)
- Architectural design
- Interactive computer graphics systems

Advantages

- High resolution
- High drawing and update speed
- Bright, crisp vectors and characters
- Choice of screen sizes
- Digital and analog display interface available

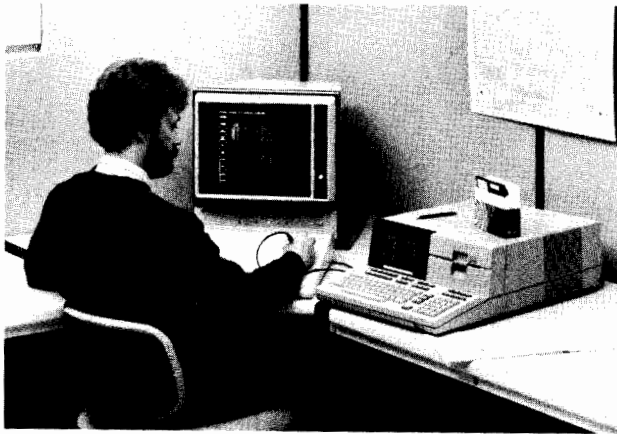

Introduction to Softcopy Graphics

The need to display and update graphical data in real-time is of primary importance in a number of computer-driven applications. It is also necessary in many applications to display the data quickly and with high resolution. To meet these needs, Hewlett-Packard offers a number of CRT displays and display systems for engineering and scientific disciplines. Depending on the particular HP display or display system chosen, available features are programmable intensity levels, programmable line types, large screens, character generation, and choice of interface.

What is Softcopy Graphics?

Softcopy graphics uses some volatile device to display the graphical information, in most cases a CRT display. Unless the picture is stored by some means, it is lost when the system is turned off. Because information is not stored by the device, softcopy graphical displays are particularly suited to interactive computer graphics systems.

Softcopy or Hardcopy?

Both hard and softcopy graphics have appropriate applications. While plotters and other hardcopy devices provide a permanent record of the picture, they cannot react in real-time. Since it takes a hardcopy device some length of time to plot, making changes to a picture, while using a plotter as a peripheral in an interactive graphics system, would be a time-consuming task. On the other hand, a CRT display can show changes to the picture in real-time, allowing the operator to alter the graphical data and see the results immediately. Because the display is not a permanent storage device, changes can be made while errors are erased from the screen. When all changes are complete, the finished picture can be "dumped" to a hardcopy peripheral for retainment.

Softcopy graphics is also essential in areas where decisions are made on the basis of rapid input of information. Radar display is an example. In such an application, high display resolution as well as high speed data-updating capability are needed to show and update complex pictures quickly.

Electronic instrumentation makes use of softcopy graphics in a number of areas such as oscilloscopes, spectrum analyzers, waveform analyzers, and logic analyzers. Because of the ability of graphics to portray large amounts of data in a form that is easily and quickly assimilated, such instruments use CRT displays.

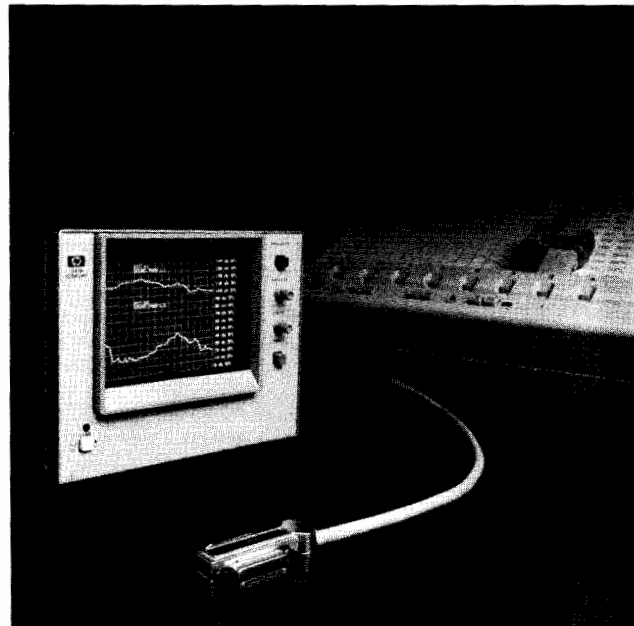

Softcopy Data-Scrolling

The 1347A HP-IB Display provides data-scrolling capability, an extremely powerful form of softcopy graphics. The 1347A can scroll through data stored in memory horizontally across the screen in both directions. It can display as many as 32 waveforms at one time, and it can scroll graticules as well as text and/or waveforms.

Softcopy data-scrolling is extremely useful in applications that require monitoring and analyzing data, and data-scrolling with the 1347A provides the data you need to analyze faster than a paper strip chart recorder can.

The softcopy data displayed on-screen while the 1347A is in its scrolling mode can be duplicated on an HP-IB/HP-G1 plotter, giving you a "snapshot" of the scrolled data. Then, the 1347A resumes scrolling after the plot is finished, losing none of the data in the interim because it stored that data in its memory.



GRAPHICS DISPLAYS

Instrumentation Graphics Systems

Models 1351S, 1351A

- Computer/calculator compatible digital interface
- Fast display updating
- High resolution graphics
- 8k vector/character generator
- 64 addressable memory files
- Optional screen sizes and phosphors



Computer Graphics Display System

The 1351S Graphics System provides a high resolution, real-time method of generating bright line vectors and/or alphanumeric characters. This cost-effective system includes a high quality, large-screen electrostatic CRT display (with programmable binary Z-axis control) and the 1351A Graphics Generator. The system gives bright graphics in minicomputer or desktop computer systems with a resolution of 1020 x 1020 addressable points on the CRT screen. In addition, it provides the fast information throughput, rapid picture manipulation, and complex vector drawing capability needed in interactive computer graphics for computer-aided design/computer-aided manufacturing (CAD/CAM) systems, and radar/simulation.

Programmable Features

The 1351A has 64 memory files that are selectable in size, separately addressable and erasable, and can be directed to flash selected information on and off. Variable vector drawing speeds provide three intensity levels for highlighting selected information. This allows the programmer to highlight on-screen menus, cursors and grids, as well as enhance 3-D drawings, add perspective, or otherwise improve visual clarity and meaning. The 1351A can also produce seven intensity levels for data differentiation via a binary Z control on the large screen display.

Each digital word in the 1351A can be a vector coordinate or an upper or lower case ASCII character. A character ROM generates each ASCII character while using only one word of RAM in the 1351A memory, making more RAM available for other display information. Each character can be programmed to be displayed in four different sizes with two orientations (horizontal and 90 degree rotation).

CAD/CAM Applications

Modeling: with the 1351S as part of a CAD system, a designer has a highly interactive display system with which to create complex wire-frame models. Through a graphics tablet or keyboard, the designer can immediately see the results of inputs. After the model has been generated, it can be stored in a computer data base for other CAD/CAM uses or for refinement later in the design process.

Analysis: a CAD/CAM system using the 1351S can also be used in stress analysis. Using the finite-element technique, the model is broken down into a network of simple elements that a computer uses

to determine stress, deflections, and other structural characteristics. For example, the 1351S can be used to display a deflected shape superimposed over the original model. With the 1351S's highlighting capability, the designer can rapidly analyze a model because the 1351S provides visual differentiation. In this way, the design can be modified prior to building costly physical models and prototypes.

Kinematics: CAD systems that include kinematic features for animating the motion of mechanisms are ideally suited to the fast drawing and selective erase capabilities of the 1351S. Complex mechanisms can be designed quickly, without the traditional pin-and-cardboard models or lengthy mathematical equations.

Drafting: CAD systems with automated drafting are many times faster than manual drafting. Such a system requires a large, high resolution CRT display for easy viewing. The high speed vector generating capability of the 1351S allows the draftsman to generate several views of a structure or of complex IC or PC drawings rapidly.

RS-232-C or 16-Bit Parallel Optional Interface

The 1351A has a flexible interface structure to allow one of three specific interfaces to be used. Changing from one interface type to another is accomplished by changing the plug-in interface card. An HP-IB interface is standard with optional RS-232-C and 16-bit parallel interfaces available.

Ordering Information*

1351S Display System (includes 1311B display)

1351A Graphics Generator (supplied with 1351S)

* An HP-IB cable is not supplied and must be ordered separately.

Options and Accessories

- 001: RS-232-C interface in lieu of standard HP-IB
- 002: 16-bit parallel interface in lieu of standard HP-IB
- 510: 1310B, 19 in. X-Y display in lieu of 1311B
- 517: 1317B, 17 in. X-Y display in lieu of 1311B
- 521: 1321B, 21 in. X-Y display in lieu of 1311B
- 604: P-4 phosphor display, no graticule
- 639: P-39 phosphor display, no graticule
- 908: Rackmount hardware for 1351A and 1311B

- Fast settling time; low power consumption
- Excellent image quality

- Ideal for use as a computer peripheral
- CRT viewing area from 14 inches to 21 inches diagonally

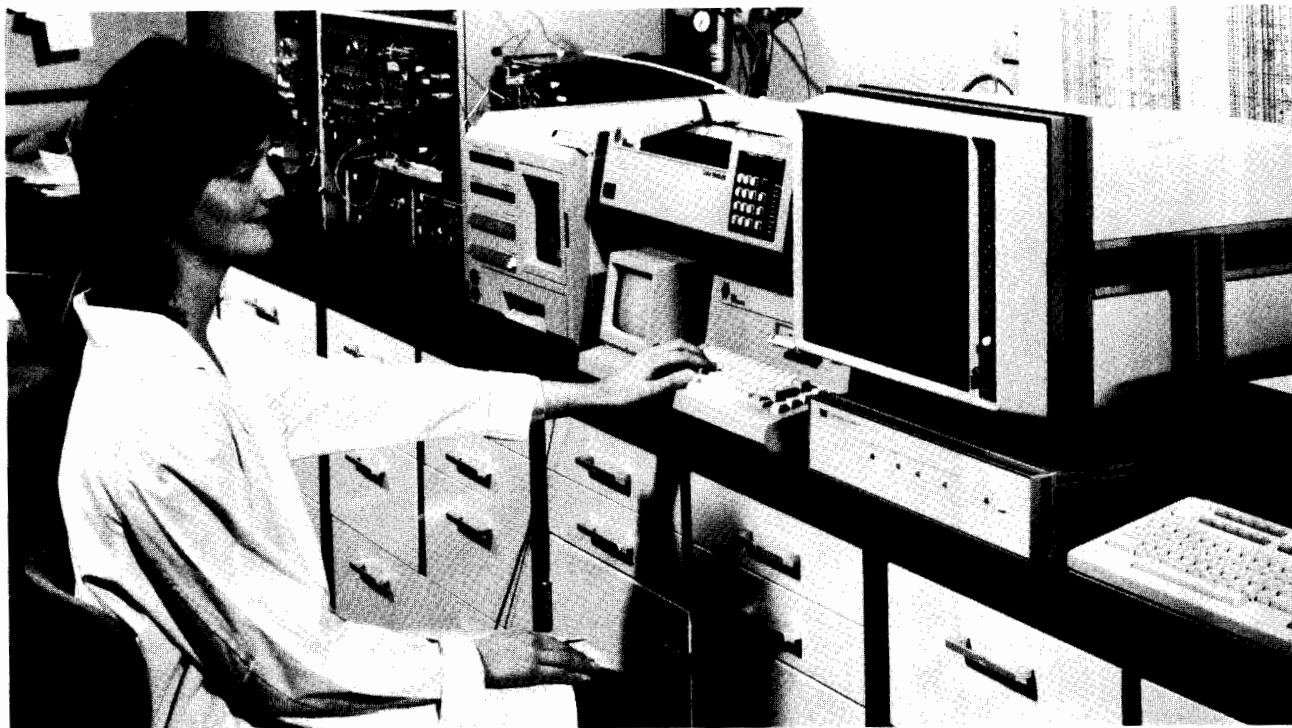

The HP 1311B is used here as the display in a chemical analysis system

Versatile Computer Graphics Displays

Hewlett-Packard's Models 1310B, 1311B, 1317B, and 1321B large screen displays offer the high writing speed, fast settling time, brightness, and contrast needed for the display of high density graphics information. These displays are ideal computer peripherals with the high picture quality and dynamic performance required for complex computer-generated graphics. Any on-screen movement can be made in less than 500 ns, including settling time. This high speed performance is particularly useful in radar and simulation, where many symbols must be moved about almost simultaneously. It is also useful in computer-aided design (CAD) applications which require complex, high density drawing capability.

These high resolution displays remain exceptionally well-focused in all parts of the screen which solves such difficult display problems as writing many characters around the picture edges, while showing great detail in curves, graphs, or diagrams. Excellent image quality is further assured with features such as a contrast control circuit which provides constant contrast with variations in intensity, and a flat, optical quality glass contrast filter which eliminates trace diffusion and minimizes glare.

The 1310B, 1311B, 1317B, and 1321B are electrically almost identical, but offer a wide range of sizes and configurations to fit almost any high-speed, large screen OEM display requirement. The 1321B has the highest overall resolution (screen area divided by spot size) of any HP CRT display, making it the choice for applications where maximum information density is the main consideration. The 1317B is ideal for standard 48.3 cm (19 in.) rack-mount applications requiring the largest possible screen area in the minimum vertical rack space. For table-top applications such as remote monitors, Models 1310B and 1311B offer an attractively styled enclosure with a tilt stand. Both displays may be ordered without the tilt stand (Opt 001) for mounting in standard 48.3 cm (19 in.) racks or custom designed enclosures.

Picture Clarity

Spot resolution of these large-screen displays is a maximum of 0.51 mm (0.020 in.)—1311B: 0.43 mm (0.017 in.)—and remains excep-

tionally well-focused in all parts of the screen. These displays use an aluminized screen and 28.5 kV accelerating potential, allowing brightness great enough to ensure a crisp presentation of complex computer graphics pictures. The 1310B, 1311B, 1317B, and 1321B use a contrast control circuit that offers constant contrast with variable intensity, ensuring excellent image quality. This allows you to increase or decrease image brightness without affecting the contrast between picture elements.

Computer Interfacing

The increasing use of mini- and microcomputers for data bases and data reduction as well as design aids has resulted in a need for high quality displays that easily interface with a computer. A cost-effective solution to a wide spectrum of demanding graphics applications such as CAD/CAM includes the HP 1351A Graphics Generator, which is an ideal interface between a computer and a 1310B, 1311B, 1317B, or a 1321B. The graphics generator can store data in memory and continually refresh the display, reducing the load on your computer.

Safety

Safety protection is designed and built into the 1310B, 1311B, 1317B, and 1321B. In each of these displays, the high voltage anode lead is permanently bonded to the CRT. The CRT complies with UL implosion and impact requirements, and X-ray emission is held below 0.5 mr/hr through the use of Strontium-doped glass.

Ordering Information

For information on options and accessories, refer to the applicable large screen CRT data sheet.

- 1310B 48 cm (19 in.) Display
- 1311B 36 cm (14 in.) Display
- 1317B 43 cm (17 in.) Display
- 1321B 53 cm (21 in.) Display

OEM discounts available



GRAPHICS DISPLAYS

Instrumentation Digital Displays

Models 1345A, 1346A, 1347A

- HP-IB/HP-GL compatibility (1346A, 1347A)
- Random vector plotting
- Programmable intensity, speed, and line type
- Bi-directional data-scrolling (1347A)
- Plot and graph modes (1346A, 1347A)
- Memory segmentation (1346A, 1347A)

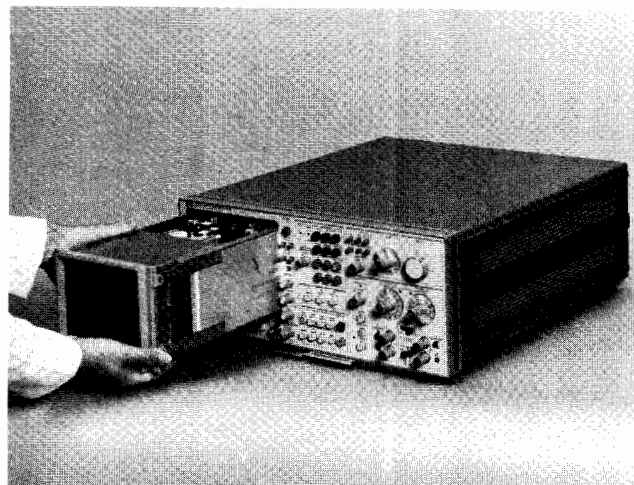
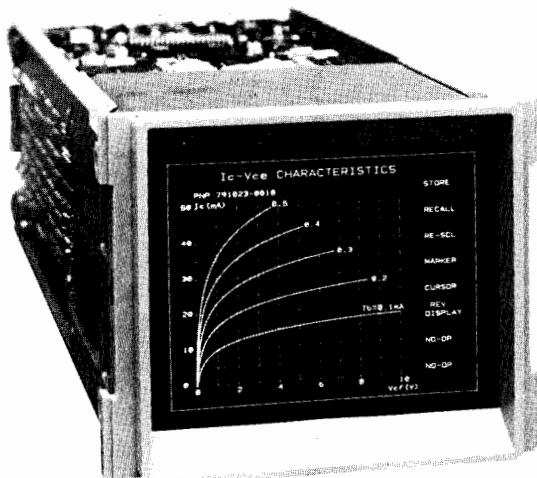

Digital Displays—OEM and End-User Models

As the trend toward computer-controlled architecture and CRT graphics continues, digitally-interfaced displays will simplify the design and development of instruments and systems. HP's digitally-interfaced displays can be easily integrated into an instrument or system, and the HP electrostatic deflection CRT supplies fast writing rates with high resolution and low power consumption.

1345A Description

The 1345A is a high performance, digital display module that generates and displays information derived from digital information received through its 16-bit TTL I/O port. Its small package occupies a minimum of space, making it easy to design into an instrument or system. With a 2048 x 2048 addressable resolution, the 1345A provides high resolution graphics and a crisp, well-focused electron beam.

In spectrum analyzers, the 1345A's high data acceptance and vector drawing rates allow complex traces to be generated as rapidly as new data are acquired. Multiple programmable intensity levels can be used to differentiate between complex overlapping traces.

When used in medical instrumentation, the 1345A's high resolution ensures that it faithfully preserves input signals for accurate diagnosis when monitoring physiological parameters. The speed of the 1345A allows it to update an entire picture, even one with several waveforms displayed, in real-time as new data are acquired.

The 1345A's light weight, low power requirement, and rugged construction make it ideal for use in portable or mobile equipment.

The 1345A module is a unitized structure, which is independently rugged without a cabinet. It can be easily integrated into almost any instrument or system console design. To simplify cabinet design, HP offers several OEM cabinets for the 1345A—these are attractively styled and accommodate circuitry for many applications.

1346A Description

The 1346A HP-IB module features an HP-IB interface, making it suitable for instrumentation systems where some or all of the instruments are on HP-IB. This feature ensures that it is compatible with virtually any computer/controller that supports HP-IB (IEEE-488 1978).

In addition to its HP-IB interface, the 1346A uses HP-GL as its interface language, allowing the software and firmware designed to drive the 1346A to drive HP-GL plotters as well. This reduces the programming and development time involved when adding CRT graphics to a system.

The 1346A has internal character generation with five selectable character sets plus four programmable character sizes and orienta-

tions. In addition, the 1346A features five programmable line types, plot mode, four programmable beam velocities, and memory segmentation, which is useful for animation/simulation applications. In addition to its 8k x 16 refresh memory, which alleviates the need for the host computer to refresh the screen, the 1346A offers a monitoring/listing capability that allows it to act as a listing device for the computer/controller.

The 1346A's two-port architecture was designed to provide fast, easy hardcopy output. One port is used exclusively to transfer data from the 1346A to an HP-IB/HP-GL plotter, while the other port transfers data and instruction to the 1346A from the computer. Either a whole picture or specified segments stored in the 1346A's memory can be sent to a plotter, and plotting can take place while the 1346A carries out input operations because the plotting operation runs in the "background."

1346A Applications

With its high performance and programmable features, the 1346A is useful in data acquisition systems that require rapid updating, densely-packed labelling, severe operational and transport conditions, and the need to display many traces simultaneously. For analytical instrumentation, the 1346A's high resolution enables it to

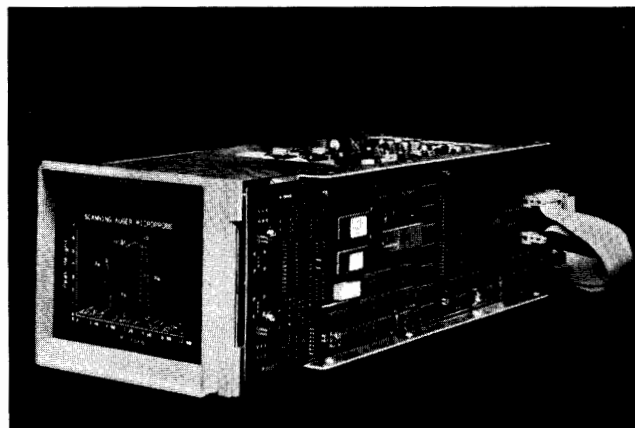



display important details in complex waveforms. Airborne instrumentation, such as avionics equipment, can use the 1346A's high update speed as well as its rugged construction and reliability. Also, the 1346A electrostatic CRT requires a minimum of power as needed in airborne applications.

As an HP-IB module, the 1346A can be easily integrated into ATE systems as a component. It can be used to display information pictorially, such as curves or graphs, for easy comprehension.

1347A Description

The 1347A HP-IB Display combines full programmability with high-speed vector graphics in a self-contained unit. With its internal power supply, it is ideal for use as an instrumentation system's display. Housed in an HP cabinet, the 1347A is suitable for rackmounting or for bench use. The 1347A has an addressable resolution of 2048 x 1513, which is needed for detailed displays in waveform analysis, data acquisition, and process control and monitoring. Using random vector plotting, the 1347A produces straight lines and smooth curves without the discontinuities produced by raster displays.

As with the 1346A, the 1347A has two HP-IB (IEEE-488) ports. One port allows a computer to input graphic commands and data to the display, and the other allows the 1347A to send graphical information off-line to an HP-IB/HP-GL plotter. This digital interface makes the 1347A easy to integrate as a peripheral in an instrumentation system.

Data-scrolling Capabilities

A key feature of the 1347A is its capability to scroll data stored in memory horizontally and bi-directionally across the screen. With its scrolling capabilities, the 1347A can display up to 32 waveforms and can scroll graticules as well as text. Because the 1347A can store information in its memory and allow the user to scroll through that information, it is useful for monitoring and analyzing data. With its data-scrolling capabilities, the 1347A is faster to use than a paper strip chart recorder, quickly giving you the data you need to analyze.

Data displayed on-screen when the 1347A is scrolling can be duplicated on an HP-IB/HP-GL plotter, giving you a "snapshot" of the scrolled data. The 1347A can resume scrolling after the plot is completed.

Segmented Memory

With its 8k x 16 memory, the 1347A can store over 8000 characters or 4000 vectors. The 1347A's refresh memory is segmented, allowing it to store up to 64 separate pictures. These pictures can be displayed in rapid succession for animation/simulation applications. Segmentation also allows you to store reference data against which you can compare test data. When testing a particular instrument or component, you can also store sets of test instructions and pictures to be displayed.

Graphing

The 1347A provides several functions that simplify generating graphs and grids. These include X and Y tick marks with user-defined lengths, reducing the time needed for generating axes. Another feature of the 1347A is its symbol mode, which causes a symbol (i.e., a character) to be drawn at the end of each vector. This allows characters to be inserted in the actual graphlines. These features facilitate drawing graphs that can be easily interpreted.

Plotting

The 1347A gives you a full range of plotting capabilities, including plot relative, plot absolute, and scale. For example, a symbol defined with plot relative statements allows you to move the symbol by simply moving the start location because all other points in the symbol are relative to the starting point. Because the 1347A is HP-GL compatible, commands are defined with syntax similar to that of HP-GL plotters. This means that software instructions to the display are easily reformatted by the 1347A to drive HP-IB/HP-GL plotters from the off-line hardcopy port. This eliminates the need to write two separate programs for driving the 1347A and the plotter, reducing the pro-

gramming and development time needed when adding CRT graphics to your system.

1347A Applications

For those involved in manufacturing, industrial automation is of primary concern as a means of improving productivity. In both manufacturing and test environments, automated functions can yield higher accuracy and less redundancy than when performed manually.

The 1347A is an ideal component for an automated test system. Its HP-IB compatibility makes it easy to integrate into an HP-IB driven system, and its HP-GL compatibility simplifies programming while maintaining the previous software investment.

Because of the high resolution, fast update speed, and graphics capabilities, the 1347A is well-suited for use in process control. As an external peripheral, it can be shared among several stations, displaying the desired system as required.

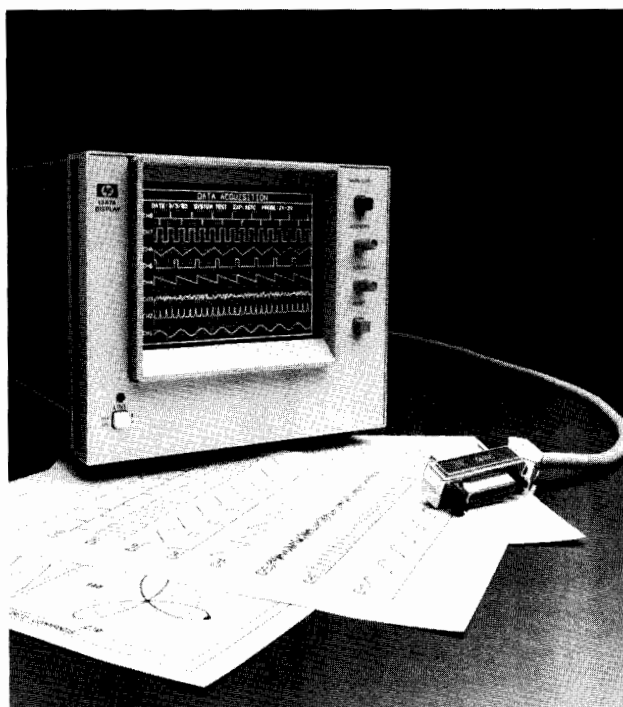

The 1347A is useful in data analysis, especially when you need to view the data in detail. The high addressable resolution of the 1347A allows data, such as voltages, to be shown in full range without obscuring minor variations. With the 1347A's data-scrolling capabilities, you can look through large amounts of data that have been previously stored. The data can be fed into the 1347A's memory (up to 32 traces) and scrolled through until the perturbation of interest is found. The data on-screen can then be copied to a plotter for a hardcopy record without plotting a lot of unnecessary information. In this way, the 1347A can be used as a softcopy strip chart recorder, with hardcopy recording as needed.

Ordering Information

1345A Digital Display Module

1346A HP-IB Module

1347A HP-IB Display



GRAPHICS DISPLAYS

Instrumentation Analog Displays

Models 1304A, 1340A

- Fast settling time (1304A: ≤ 300 ns)
- Designed for production test as well as monitoring and diagnostic systems
- Easy system integration
- Low power consumption (1304: ≈ 60 W nominal)

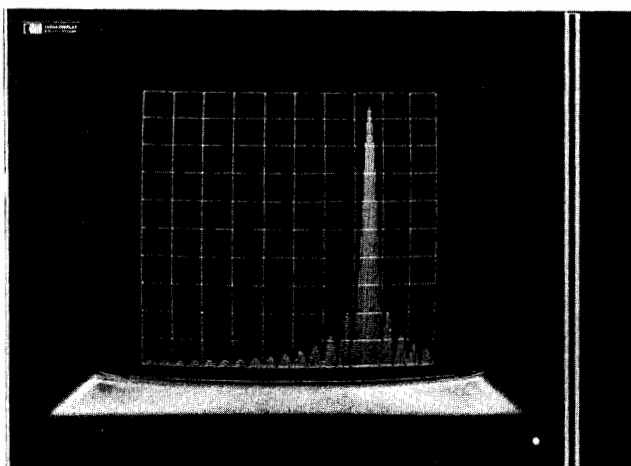

1304A 14-inch XYZ Display

High Performance Plus Easy System Integration

The HP 1304A (36 cm/14 in) large-screen display and the 1340A (15.3 cm/6 in) analog display module are designed for production test and measurement systems as well as for analytical instrumentation. They both provide high quality graphics and are easy to integrate into instruments and systems.

1304A Description

With its high writing speed and fast settling time (≤ 300 ns), the 1304A is useful in monitoring applications requiring multiple traces to be displayed on-screen (e.g., a multiple-bed patient monitoring system). The line brightness and resolution of the 1304A's CRT allow it to present up to 2000 characters or complex graphic data in normally-lighted industrial environments. Its neutral density contrast filter enhances the trace-to-background contrast for improved readability.

Its large viewing area (500 cm²/77.4 in²) make the 1304A useful for applications such as fast Fourier transform analyzers, automatic test systems, diagnostic ultrasonics, weather/harbor/fire control radar, patient monitoring, and chemical/physical analysis instruments.

1340A Description

The 1340A is a rugged display module that is easy to integrate into an instrument or system console. HP offers a variety of cabinet configurations for the 1340A, simplifying system design. Also available is an option to make the 1340A a free-standing display for use with instruments that do not have a built-in display.

The 1340A's integrated circuits contain most of the X, Y, Z amplifier components, ensuring the 1340A's high reliability. The X and Y attenuators, input impedance, polarity, and bandwidth limiting are internally switch selectable, providing design flexibility when the 1340A is used in a system or with more than one instrument.

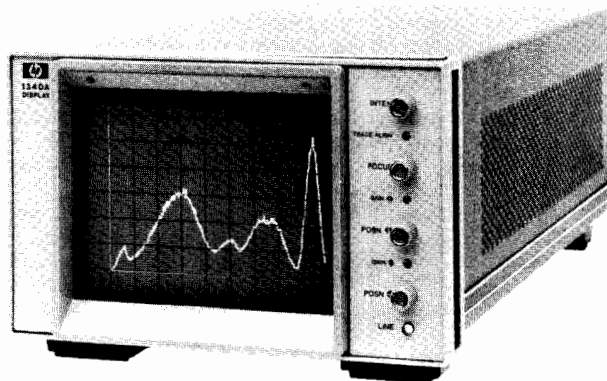

1340A Display Module in HP cabinet (opt 315)

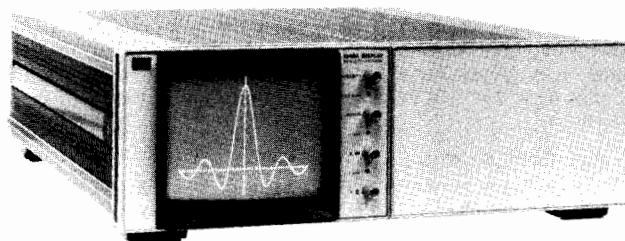

1340A Display Module in HP cabinet (opt 317)

The 1340A has a separate control panel that can be located to suit the design. For simplicity in integrating the 1340A, its control functions are all dc inputs (0 to 5V) to the IC amplifiers. The controls can be operated remotely from the 1340A, or you can order the 1340A without a control panel if you want to use your own controls.

The small space requirements of the 1340A and the light weight of dc power option 002 make it ideal for airborne or system applications requiring minimum size and weight.

The 1340A's resolution, viewing area (114 cm²/17.7 in²), and brightness make it suitable for spectrum, network, and logic analyzers as well as for non-destructive test systems or instruments. It is also useful as a display for communication system analyzers, chemical and scientific analysis systems, and some medical diagnostic systems.

Ordering Information

- 1304A Large Screen Display
- 1340A Analog Display Module (with control panel)
- 1340A Opt. 315 System II Half rack Cabinet
- 1340A Opt. 317 Full rack with Cabinet

GRAPHICS DISPLAYS

High Resolution Imaging Displays

Models 1332A, 1335A, 1336S



- Designed for OEM scientific measurement and diagnostic systems
- Easy to view and easy to photograph

- Variable persistence storage for monitoring applications
- Many options for versatility

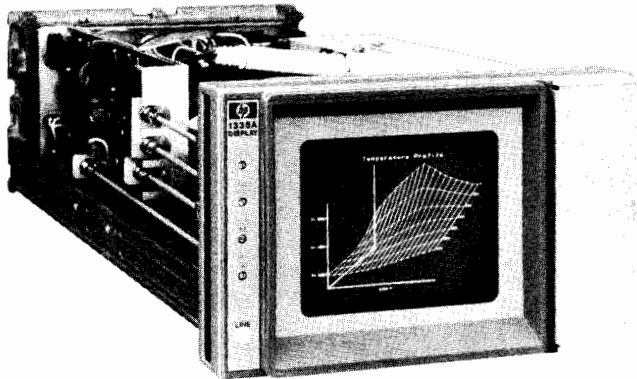

1335A Storage Display

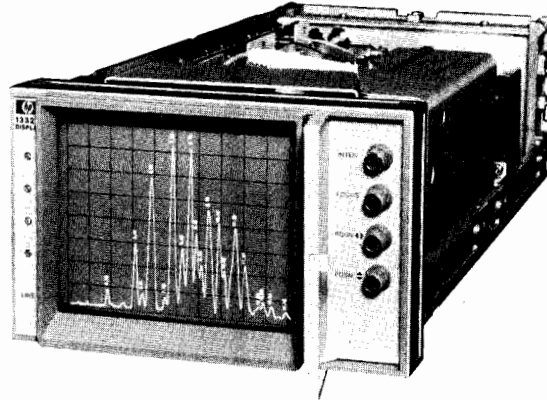

1332A 7-inch XYZ Display

Real-Time Graphics for High Resolution Imaging

HP's 1332A, 1335A, and 1336S graphics displays are designed to meet the high resolution and imaging requirements of OEM scientific measurement and diagnostic systems. Applications for these displays include spectrum, network, and chemical analyzers, nuclear medicine, medical ultrasound, and nondestructive test systems.

Easy Viewing

The 1332A's high resolution display is easy to view and is easy to photograph. It is bright enough for viewing in high ambient light while maintaining its resolution and gray shades when being photographed. The 1332A's CRT, which has a display area of 9.6 x 11.9 cm, has an accelerating potential of 22.5 kV, and it provides a bright, sharply-defined trace at all Z-axis drive levels and in all areas of the screen. Its spot screen of 0.035 mm (0.012 in) is maintained over the entire quality area. This is useful for displaying alphanumeric characters along the screen's extreme edges.

Variable Persistence Storage

For variable persistence storage applications, the 1335A offers an exceptionally uniform display as needed in OEM medical and instrumentation systems. The 1335A's variable persistence mode can be used for monitoring slowly changing phenomena because it increases persistence to match the refresh rate. In the storage mode, the 1335A's resolution is 20 lines per cm (i.e., 50 lines/in) permitting it to retain sharp details. Furthermore, you can select any operating mode (i.e., store, write, conventional, variable persistence, or erase) either manually with front panel controls, remotely with program inputs, or with a combination of both.

Basic Operation

The X- and Y-amplifiers of the 1332A and 1335A settle to within one spot diameter of final position in less than 300 ns, and they can slew linearly at deflection speeds of up to 25 cm/ μ s (10 in/ μ s). This speed permits them to draw thousands of points, vectors, and/or characters at high refresh rates without sacrificing brightness due to long wait times between successive points or vectors. A fast Z-axis rise time of 25 ns permits clearly-defined vector start and stop points to ensure that an image's resolution is not limited by video bandwidth. In addition, all amplifiers have a full differential, low-power design for stable, drift-free operation with minimum warmup.

Options for a Custom Display

Many options are available for the 1332A and 1335A that allow you to tailor them for almost any OEM application. Options include a selection of input deflection factors, blanking ranges, input polarity

and impedance, differential inputs, and CRT phosphors. An optional TTL blanking input unconditionally overrides both the analog Z-axis input and the intensity control, and it can protect the CRT if the system fails. A gamma-correction option causes the light output to vary linearly (+/-20%) as the Z-axis input voltage changes. This reduces the complexity of the system circuitry when using Z-axis modulation to maintain constant brightness of vectors written at varying speeds.

System Solution

The 1336S consists of display module (1336A) and a separate power supply module (1336P). Offering a choice of either 140 lines/cm or 90 lines/cm (i.e., through option 005) resolution, the 1336S can be used in multi-imaging applications such as in nuclear or ultrasound medical diagnostic systems.

Designed-In Safety

Attention to safety requirements is involved in all aspects of HP graphics displays, from the initial design through manufacturing and quality control. In addition, regular inspections by UL and CSA inspectors ensure that end-user protection is built into every display. The 1332A, 1335A, and 1336S are listed with Underwriters Laboratories in accordance with the UL 544 Medical Safety Standard that defines detailed patient protection requirements.

Cabinet Sizes

Models 1332A, and 1335A are 13.3 cm (5 1/4 in.) high, half rack width, 49.5 cm (19 1/2 in.) long packages that can be combined with identical empty modules to form an attractive full width horizontal or vertically stacked OEM instrument. The 1336A Display Module has the same dimensions and the 1336P Power Supply Module has the same height and width but is 33.5 cm (13 3/8 in.) deep. If the 1336A/P are to be mounted together, 1336P Option 018 may be ordered to provide the same cabinet depth as the 1336A, with locking hardware to form a standard EIA rack width unit.

Ordering Information

1332A Small Screen Display
1335A Small Screen, Variable Persistence Storage
1336A Display Module
1336P Power Supply Module
1336S Display System (includes 1336A, 1336P)
1336A or 1336S Opt 005
10183 Light Shield for 1332A, 1335A, 1340A, 1338A
OEM and quantity discounts available.

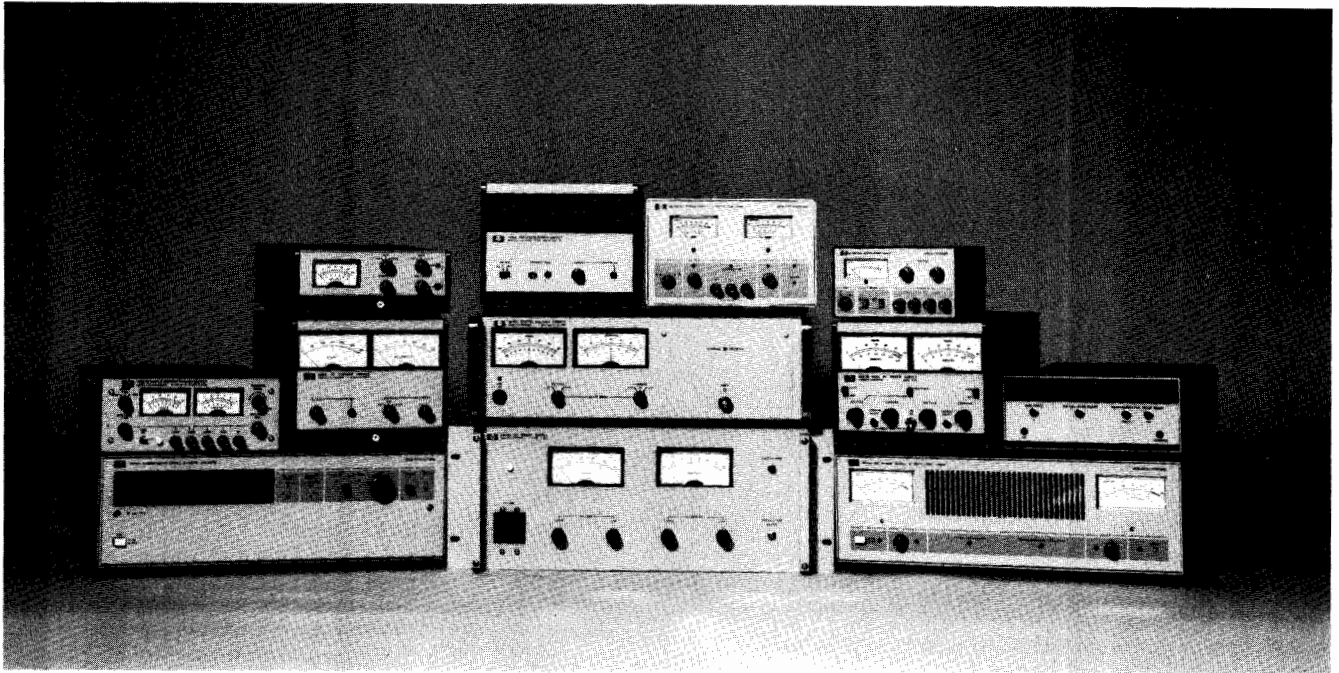

Introduction

Hewlett-Packard's extensive variety of power supplies serve a wide range of applications. For circuit and device development, there are laboratory supplies. For industrial needs, these are high power units. The HP-IB power sources manufactured by Hewlett-Packard are used in automated systems, and OEM Modular Power Supplies are designed for incorporation into other products. Through technological innovations, Hewlett-Packard strives to offer advanced capabilities, high reliability, and good value in both system and bench power supply families.

Regulation Techniques

The regulation technique used in a power supply defines its performance specifications, size, and efficiency. HP power supplies are designed using one of four proven regulation techniques: Series, SCR, SCR preregulator/series regulator, and switching.

Series regulation: this technique exhibits good regulation, low ripple and noise, and fast transient response. However, it is relatively inefficient. This results in greater power usage, large size, and more generated heat than the other methods. For this reason, series regulation is most useful for lower power units. These power supplies are used in laboratory and test applications, where stable, precise, dc power is needed.

SCR regulation: this technique is more efficient than series regulation, so the power supplies have lower power usage, smaller heat sinks, and less generated heat. However, the regulation, (PARD ripple and noise), and transient response specifications are better with series regulation than with SCR regulation. Power supplies with SCR regulation are especially useful for high power industrial applications, where fine regulation is not necessary, and the lower cost/watt is important.

SCR preregulation/series regulator: this technique combines the best qualities of series and SCR regulation. As can be seen in the table, the operating specifications are much better than with SCR regulation. SCR preregulation does not detract from the excellent characteristic of series regulation, except for slower transient response. The efficiency is higher than that with series regulation, but not quite as high as with SCR regulation alone. These power supplies are used in similar laboratory and test applications as series regulated power supplies, but at power levels greater than 75 watts.

Switching regulation: this technique provides high efficiency, and operating specifications similar to series regulation (see table). These power supplies also tend to be small and lightweight.

Example Power Supply Comparison for a 40 V, 25 A, 1000 Watt Application

Regulation Technique	Model Number	PARD (ripple and noise) rms/p-p	Load Effect	Load Transient Recovery	Typical Efficiency
Series with SCR preregulation	6268B 40 V @ 30 A	1 mV/5 mV	01% + 200 μ V (4.2 mV at 40 V)	50 μ s, 10 mV	60%
Switching (autoranging)	6012A 60 V @ 50 A	5 mV/50 mV	.01% + 5 mV (9 mV at 40 V)	2 ms, 100 mV	75%
SCR	6434B 40 V @ 25 A	40 mV/500 mV	40 mV	200 ms, 200 mV	70%

Autoranging — the Best Value

An autoranging power supply can provide maximum rated power over a wide range of voltage and current without external intervention. For example, the graph of general purpose power supplies maximum output points on the following page shows a few units which have continuous curves rather than single points. These power supplies provide more application flexibility than conventional units of the same power rating. The autoranging capability is implemented either with switching regulation (6024A, 6012A, 6034A) or series regulation (6002A). For either bench or system use, autoranging usually provides the best value, at up to 1000 watts.

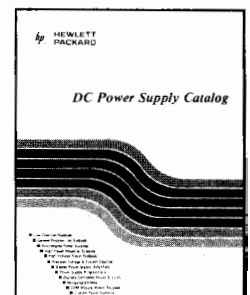

For more details concerning Hewlett-Packard power supplies, ask your HP Field Engineer for a *DC Power Supply Catalog*, or fill in the card at the back of this catalog.



Selecting a Model

A guide to power supply selection is presented on the next three pages. It can be used to quickly and easily choose the right power supply for a particular application.

The first step in the selection process is to turn to the pages that are appropriate for your application: either system or bench. For a system power supply application, continue with the section entitled System Power Supplies, which begins on the following page.

Some specialized applications require power supplies with specific features enhanced. These are known as special purpose power supplies, and include:

- High voltage (>600 volts) power supplies
- Bipolar power supply/amplifiers
- Precision voltage sources
- Precision current sources

These special purpose power supplies are described in more detail on the following page.

Hewlett-Packard offers a wide variety of general purpose power supplies, which meet the needs of diverse laboratory and industrial applications. They range in power rating from 10 to 11,000 watts. Single and multiple output power supplies are presented separately for easy indexing in the figures below. When choosing a general purpose power supply, keep in mind the benefits of autoranging, described on the previous page. Autoranging power supplies are often the best value.

Bench Power Supplies

Single Output

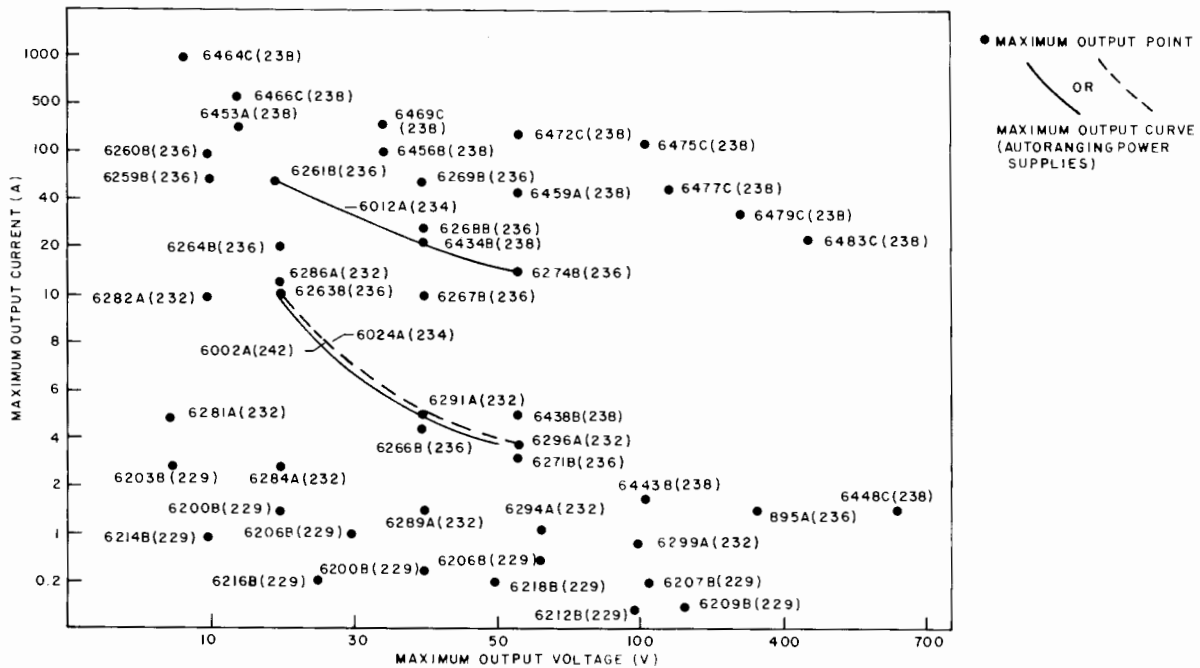

To choose a power supply using the graph above, first locate the point which corresponds to the maximum voltage and current needed, then find the model number printed closest to that point. More details

concerning that particular power supply can be found on the page which is printed in parentheses next to the model number.

Multiple Output

Model #	OUTPUT 1		OUTPUT 2		OUTPUT 3		Page
	Volts	Amps	Volts	Amps	Volts	Amps	
6234A	0-25	0-0.2	0-25	0-0.2	—	—	229
6205C	0-20	0-0.6	0-20	0-0.6	—	—	229
(dual range)	0-40	0-0.3	0-40	0-0.3	—	—	
6235A	0-6	0-1	0-18	0-0.2	0-18	0-0.2	230
6236B	0-6	0-2.5	0-20	0-0.5	-20-0	0-0.5	230
6237B	0-18	0-1	0-20	0-0.5	-20-0	0-0.5	230
6227B	0-25	0-2	0-25	0-2	—	—	232
6228B	0-50	0-1	0-50	0-1	—	—	232
6253A	0-20	0-3	0-20	0-3	—	—	232
6255A	0-40	0-1.5	0-40	0-1.5	—	—	232

—These power supplies are dual output units.

Special Purpose Bench Power Supplies

Bipolar Power Supply/Amplifiers (page 245)

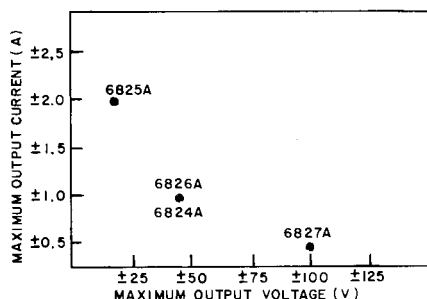

These versatile units can be used as either power supplies or amplifiers. They have bipolar voltage output and can source or sink current. Models 6825A-6827A offer a signal to noise ratio of approximately 80db at full output with low distortion, and frequency response of up to 40 kHz.

Precision Voltage Sources (page 246)

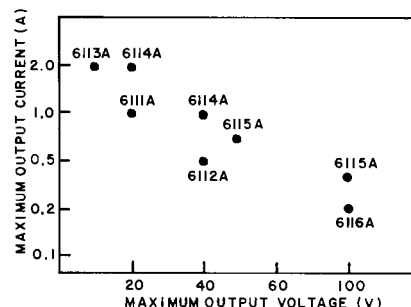

The 6114A and 6115A offer 0.0005% regulation in constant voltage mode and 0.01% in constant current mode. Models 6111A, 6112A, 6113A and 6116A offer 0.001% regulation of voltage. The precision voltage sources have less than 40 μ V rms or less. Their many applications include working voltage standards, and high stability lab supplies.

High Voltage Power Supplies (page 248)

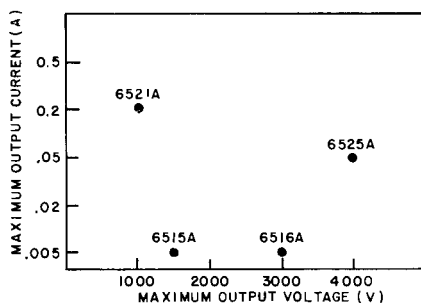

These supplies provide 0.005% or 0.01% regulation, and less than 2mV rms ripple and noise. Models 6521A and 6525A provide 0.002% resolution; model 6515A provides 0.006%, and the 6516A provides 0.03%. These units have enough output current to power devices such as TWT's, klystrons, magnetrons and electron beam welding devices. These power supplies are not remotely programmable.

Precision Current Sources (page 247)

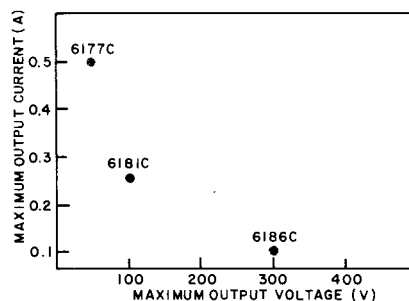

These accurate, stable high-resolution units are optimized for constant current operation. They are especially useful for semiconductor testing and development. Ripple and noise is less than 0.002% of full scale output current, and resolution is 0.03% of range.

System Power Supplies

The correct solution for a particular system application depends upon many factors including: the number of different voltage or current outputs needed simultaneously, the power supply specifications required and the degree of programmability desired.

If multiple outputs are needed, approaches are available which are more cost effective than complete duplication of single output system power supplies. These are discussed in the section entitled "Multiple Output System Power Supplies" on the following page.

Some systems require power supplies with specific features enhanced. These special purpose system supplies are described on the following page.

Many automatic test applications require more than programmable voltage or programmable current. If capabilities such as readback of output voltage or current, programmable OVP level, and status readback are desired, the 6034A Autoranging System Supply should be

used. The 6034A is the best solution for most system power supply applications up to 200 watts.

Hewlett-Packard offers a wide variety of general purpose system power supplies, which meet the needs of many diverse laboratory and industrial applications. They range in power to 11,000 watts. To find the model which meets your maximum voltage and current needs, use the graph on the following page. Most of the models listed are used with the 59501B HP-IB Power Supply Programmer. When choosing a system power supply, keep in mind the benefits of autoranging discussed on page 224.

59501B Power Supply Programmer

The 59501B is an HP-IB Isolated Digital to Analog Converter. It can be used to program the current or voltage output of many Hewlett-Packard power supplies. Specifications of the 59501B Power Supply Programmer can be found on page 243.

Single Output System Power Supplies

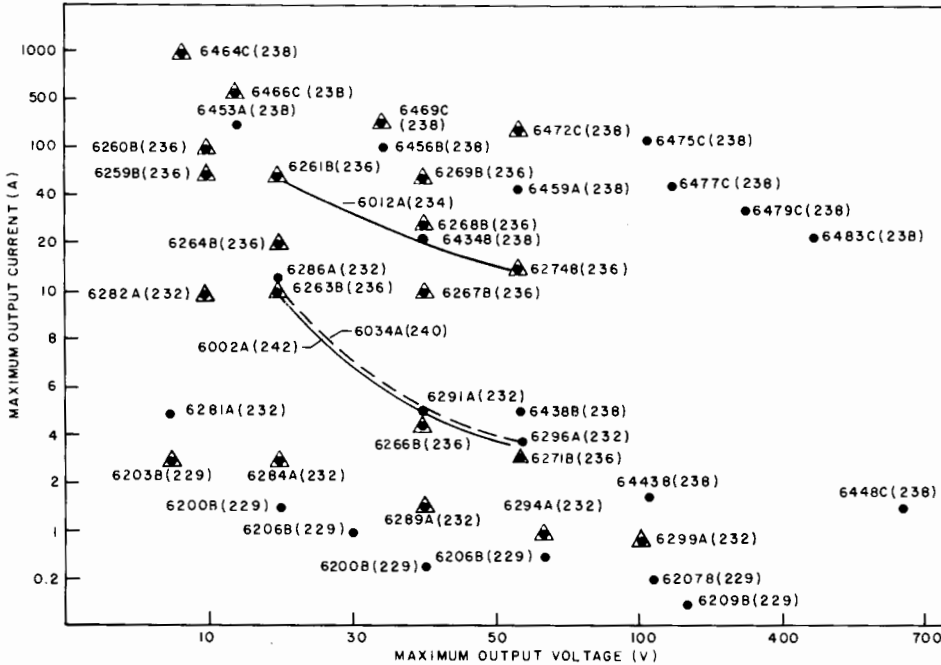

MAXIMUM OUTPUT POINTS
 ● PROGRAMMED WITH THE 59501B POWER SUPPLY PROGRAMMER
 NOTE: MODELS 6434B-6448B AND 6466C-6483C MUST BE ORDERED WITH SPECIAL OPTION J30 TO BE PROGRAMMED WITH THE 59501B.

△ MAY BE PROGRAMMED WITH THE 6942A OR 6940B INSTEAD OF THE 59501B

MAXIMUM OUTPUT CURVES
 (FOR AUTORANGING POWER SUPPLIES)

OR

6012A PROGRAMMED WITH THE 59501B POWER SUPPLY PROGRAMMER
 6034A AND 6002A DIRECTLY PROGRAMMED



To choose a power supply using the graph above, first locate the point which corresponds to the voltage and current ratings needed, then find the model number printed closest to that point. More details

concerning that particular power supply can be found on the page which is listed in parentheses next to the model number.

Special Purpose System Power Supplies

Precision System Supplies

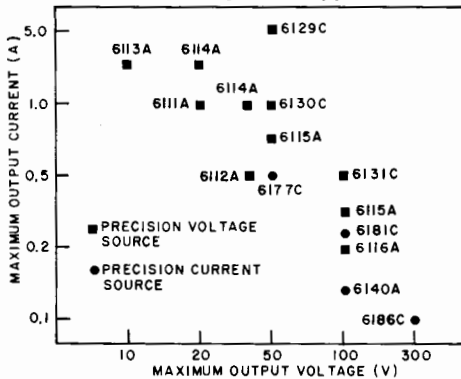

The 6129C-6131C voltage sources and 6140A current source (page 244) offer fast accurate, high resolution, bipolar output. They are used with the 59301A ASCII to Parallel Converter.

The 6111A-6116A voltage sources (page 246) and 6177C-6186C current sources (page 247) are high stability, moderate resolution, system power sources, when programmed with the 59501B Power Supply Programmer.

Multiple Output System Power Supplies

When more than one power supply output is needed, there are two cost effective system approaches which can be used. A dual output power supply can be used to replace two single output units, and a Multiprogrammer (6940B or 6942A) can be used to program multiple power supplies. The Multiprogrammer solution is generally cost effective when four or more power supply outputs are needed.

The following power supplies can be programmed with either the 59501B Power Supply Programmer or the Multiprogrammers:

Model #	OUTPUT 1		OUTPUT 2		Page
	Volts	Amps	Volts	Amps	
6205C	0-20 & 40	0-0.6 & 0.3	0-20 & 40	0-0.6 & 0.3	229
6227B	0-25	0-2	0-25	0-2	232
6228B	0-50	0-1	0-50	0-1	232
6253A	0-20	0-3	0-20	0-3	232
6255A	0-40	0-1.5	0-40	0-1.5	232

Bipolar System Supplies

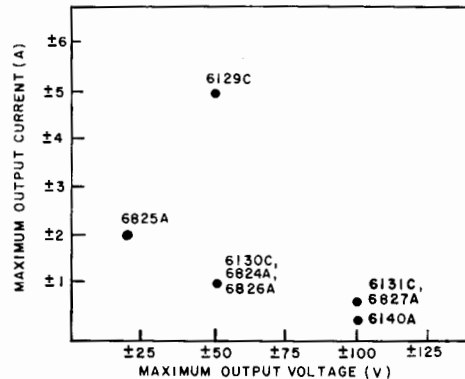

The 6129C-6131C voltage sources and 6140A current source (page 244) offer fast, accurate, high resolution, bipolar output. These supplies are programmed with the 59301A ASCII to Parallel Converter.

The 6824A-6827A Bipolar Power Supply/Amplifiers (page 245) are programmed with the 59501B Power Supply Programmer. They are fast bipolar system supplies.

Multiprogrammers and the associated resistance output cards can be used to program many of the Hewlett-Packard power supplies. A Multiprogrammer can control the voltage or current outputs of the power supplies marked with a Δ on the single output graph above, models 6111A-6115A, and the dual output power supplies listed in the table at the left, when the supplies are equipped with Option 040. The Multiprogrammers have many other capabilities including digital inputs and outputs, voltage and current DAC's, thermocouple measurements, relays, and A/D's. See page 62 for more information concerning the 6940B or 6942A Multiprogrammers.

Full feature programming cards are used with the auto-ranging power supplies 6024A (200 watts) and 6012A (1000 watts). For use with these cards, the power supplies should be equipped with Option 002. The 69520A Power Supply Programming Card used in a 6940B provides voltage and current programming, status readback, and OVP set and reset. The 69709A card, used in the 6942A provides the above capabilities plus output voltage and current readback.



Power Supply Terms

Ambient temperature: the temperature of the air immediately surrounding the power supply.

Auto-parallel operation: a master-slave connection of the outputs of two or more supplies used for obtaining a current output greater than can be obtained from one supply.

Autoranging power supply: a power supply that can provide maximum rated power over a wide range of voltage and current without external intervention to change range.

Auto-series operation: a master-slave connection of the outputs of two or more supplies used for obtaining a voltage greater than can be obtained from one supply.

Auto-tracking operation: a master-slave connection of two or more supplies each of which has one of its output terminals in common with one of the output terminals of all of the other supplies.

Complementary tracking: a master-slave interconnection of two supplies in which the voltage of the slave is equal to or proportional to that of the master and of opposite polarity with respect to a common point.

Compliance voltage: the output voltage of a power supply operating in the constant-current mode.

Constant-current (CC) power supply: a power supply that stabilizes output current with respect to changes in influence quantities. Thus, for a change in load resistance, the output current remains constant while the output voltage changes by whatever amount necessary to accomplish this.

Constant-voltage (CV) power supply: a power supply that stabilizes output voltage with respect to changes in influence quantities. Thus, for a change in load resistance, the output voltage remains constant while the output current changes by whatever amount necessary to accomplish this.

Constant-voltage/constant-current (CV/CC) power supply: a power supply that operates as a constant voltage power supply or a constant-current power supply depending on load conditions. It acts as a constant-voltage source for comparatively large values of load resistance and as a constant-current source for comparatively small values of load resistance.

Constant-voltage/current-limiting (CV/CL) power supply: a power supply similar to a constant-voltage/constant current supply except that at comparatively small values of load resistance, its output current is limited instead of being stabilized.

Crowbar: see overvoltage protection.

Current limiting: the action of limiting the output current of a constant-voltage supply to some predetermined maximum value (fixed or adjustable) and automatically restoring the output voltage to its normal value when the overload or short circuit is removed. There are three types of current limiting: 1) by constant-voltage/constant-current crossover, 2) by decreasing the output voltage as the current increases, 3) by decreasing both voltage and current as the load resistance decreases (referred to as foldback or cutback current limiting).

Drift: the maximum change of an output voltage or current during an 8-hour period following a 30-minute warmup, with all influence and control quantities maintained constant during the warm-up time and the period of drift measurement. Drift includes both periodic and random deviations over the bandwidth from zero frequency (dc) to a specified upper frequency limit (usually 20 Hz).

Load effect: formerly known as load regulation, load effect is the change in the steady-state value of the stabilized output voltage or current resulting from a full-load change in the load current of a constant-voltage supply or the load voltage of a constant-current supply, with all other influence quantities maintained constant.

Load effect transient recovery time: the time interval between a specified step change in the load current of a constant-voltage supply (usually a full-load or 5-amp change, whichever is smaller) or in the load voltage of a constant-current supply and the instant when the stabilized output quantity returns to and stays within the specified transient recovery band.

Master-slave operation: a method of interconnecting two or more supplies such that one of them (the master) serves to control the others (the slaves). The outputs of the slave supplies always remain equal to or proportional to the output of the master. The outputs of the

master supply and of one or more slaves may be connected in series, in parallel, or with just their negative or positive output terminals in common. (See also complementary tracking.)

Nominal value: the value that exists "in name only," not the actual value. For example, in the case of a power supply with a calibrated output control, the nominal value is the value indicated by the control setting. For a supply with a fixed output, the nominal output is the output indicated on the nameplate. The nominal value of a 120-volt $\pm 10\%$ line voltage is 120 volts.

Output impedance: the complex ratio of a sinusoidal voltage and sinusoidal current at the output terminals, the one being caused by the other and being of external origin.

Overcurrent protection: protection of the power supply and/or connected equipment against excessive output current.

Overtemperature protection: protection of the power supply or parts of it against temperatures exceeding specified values.

Overvoltage protection: protection of the power supply and/or connected equipment against excessive output voltage. Overvoltage protection is usually by means of a crowbar protection circuit, which rapidly places a low resistance shunt across the supply's output terminals to reduce output voltage to a low value if a predetermined voltage is exceeded. A supply equipped with an overvoltage crowbar must also be protected by a means of limiting or interrupting output current.

PARD (acronym for periodic and random deviation): the term PARD replaces the former term ripple and noise. PARD is the periodic and random deviation of a dc output voltage or current from its average value, over a specified bandwidth (20 Hz to 20 MHz; except Models 6515A-6525A: 1 Hz to 20 MHz) and with all influence and control quantities maintained constant).

Programming speed: the maximum time required for the programmed output voltage or current to change from a specified initial value (usually zero or maximum output) to a value within a specified tolerance band of a specified newly programmed value (for most models 99.9% or 0.1% of maximum output, respectively; 99% and 1% for the 6111A-6116A, 6177C-6186C, and 6428B-6483C) following the onset of a step change in an analog programming signal, or the gating of a digital signal.

Remote control: also referred to as remote programming, remote control is the setting of the power supply voltage, current, or other function by means of an external control quantity such as a variable resistance, voltage, or current, or a digital signal.

Remote sensing: remote sensing, or remote error sensing, is a means by which a power supply monitors the stabilized voltage directly at the load using extra sensing leads. The resulting circuit action compensates for voltage drops in the load leads (up to a specified limit).

Resolution: for a bench supply, the smallest change in output voltage or current that can be obtained using the front panel controls. For a system supply, the smallest change that can be obtained either using the front panel controls, or a computer.

Reverse voltage protection: protection of the power supply against reverse voltage applied at the output terminals.

Slave operation: see master-slave operation.

Source effect: formerly known as line regulation, source effect is the change in the steady-state value of the stabilized output voltage on current resulting from any change in the source voltage within its specified range, with all other influence quantities maintained constant. Source effect may be measured at any output voltage and current within rating.

Temperature effect coefficient: the maximum steady-state change in a power supply's output voltage or current per degree Celsius following a change in the ambient temperature within specified limits, with all other influence quantities maintained constant.

Voltage limiting: the action of limiting the output voltage of a constant-current supply to some predetermined maximum value (fixed or adjustable) and automatically restoring the output current to its normal value when the load conditions are restored to normal. There are two types of voltage limiting: 1) by constant-voltage/constant-current crossover, 2) by decreasing the output current as the voltage increases.

Warm-up time: the time interval after switching on a power supply until it complies with all performance specifications.



- 6212B-6218B... 10 watts output
- Compact, impact-resistant stackable case
- Short-circuit proof

- 6200B-6209B... 30 watts output
- Auto series, parallel, and tracking
- Remote sensing

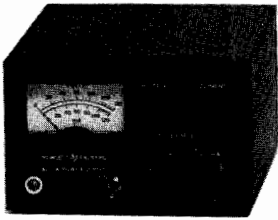

Single Output: 6212B-6218B

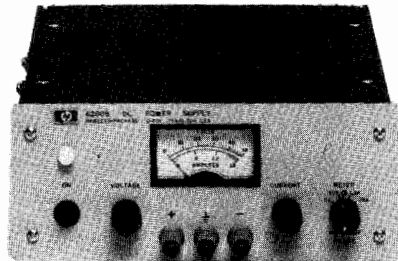

Single Output: 6200B-6209B

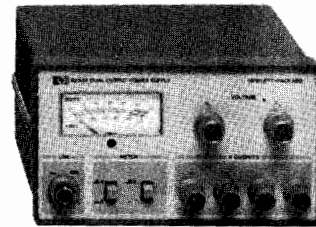

Dual Output: 6234A

Description—Single Output Models

Models 6212B-6218B

These popular low-cost CV/CC bench supplies are designed for general laboratory use and are equipped with front-panel mounted voltage and current controls, a combination volt/ammeter, and output binding posts. Output voltage and current are continuously variable, via coarse and fine controls from 0 to 15% above the maximum rated output. A switch selects either output voltage or current for display on the panel meter.

Load connections are made via three binding posts. Either the + or the - post may be grounded through an adjacent GND terminal or the supply may be operated floating at up to 300 volts above ground.

The supplies can also be operated as constant current sources with 500 μ A load regulation. All of these models can be connected in series or parallel.

The molded, impact-resistant case includes an interlocking feature for stacking several units vertically, thus minimizing bench space required for multiple supplies. Alternatively, up to three units can be mounted side by side in a 19" rack using Rack Mounting Kit 14521B. These supplies measure 86 H x 133 W x 368 mmD (3.40" x 5.25" x 8") and weigh 2 kg (4.4 lb).

Models 6200B-6209B

This series of low-cost bench supplies includes five models covering an output voltage range from 0–7.5 V to 0–320 V. All models are equipped with ten-turn voltage and current controls, (except the 6206B, which does not have a current control), volt/ampere meter, meter function/range switch, and front and rear output terminals. In addition, on the dual-range models (6200B and 6206B), an output range switch permits the selection of either a high or a low output voltage range.

The constant voltage/current limiting supply, 6206B, is short-circuit protected by a fixed current limiting circuit which is activated at approximately 110% of rated load current. The current-limit point can be reduced by changing the value of a single internal resistor. For the constant voltage/constant current supplies, ten-turn current controls allow the current-limit point to be set to any value within the current rating. Using these controls the CV/CC supplies can also be operated as constant-current sources.

Units may be bench operated or rack mounted individually or in pairs using accessory rack mounting hardware.

All models in this group of supplies measure 89 H x 216 W x 317 mm D (3.50" x 8.50" x 12.50") and weigh 4.5 kg (10 lb).

Description—Dual Output Models

Model 6234A

Model 6234A is a low-cost, dual-output bench power supply with two independently adjustable and isolated power sources in one compact unit. Both of the dc power sources are of the constant voltage/current limit type with each output voltage being adjustable continuously over a 0 to 25 V range. The maximum current available per output is 0.2 A and is limited automatically to prevent over-load.

The HP 6234A offers considerable flexibility to the user with output voltages that can be arranged to provide identical or different voltages in any polarity combination with respect to 0 or other common positive or negative voltage points. The outputs can also be connected in series to provide up to 50 V at 0.2 A. Both sources are fully isolated to permit either of the output terminals to be grounded.

With pushbutton switches, users can select either voltage or current for each output to be monitored on the unit's meter. Other features include two multiple-turn controls for precise voltage setting, regulation to 0.01% and ripple and noise of less than 200 microvolts rms.

With dimensions of only 93 mm high, 157 mm wide and 210 mm deep (3.64" x 6.17" x 8.25"), the HP 6234A supply takes up a minimum amount of bench space. Its weight is 2.3 kg (5 lbs.). The unit can be powered from a 115 V or an optional 230 V, 47-63 Hz ac input, (Option 028).

Model 6205C

This low-cost bench supply is equipped with ten-turn output voltage controls, volt/ampere meter, meter function/ range switch, and front and rear output terminals. In addition, an output range switch permits the selection of either a high or a low output voltage range.

Model 6205C combines the versatility of a dual power supply with the flexibility of auto-parallel and auto-series operation to extend the output ratings of this supply to 20 V/1.2 A, 40 V/0.6 A, and 80 V/0.3 A. In addition, using the supply's auto-tracking capability, opposite



POWER SUPPLIES

Laboratory: Single & Multiple Output, 10W to 38W

Models 6200B-6218B and 6234A-6237B (cont.)

- Dual output to 24 watts
- Short-circuit proof
- Independent voltage controls
- Triple output to 38 watts
- Short circuit proof
- Tracking ± 20 volt outputs

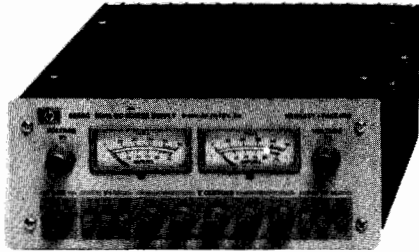

Dual Output: 6205C

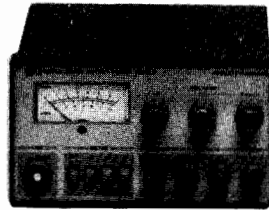

Triple Output: 6235A

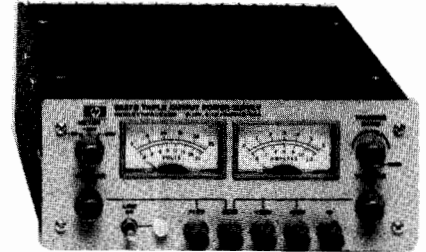

Triple Output: 6236B, 6237B

polarity voltages (± 20 V, ± 40 V) can conveniently be obtained from this one supply.

This constant voltage/current limiting supply is short-circuit protected by a fixed current limiting circuit which is activated at approximately 110% of rated load current. The current-limit point can be reduced by changing the value of a single internal resistor. Units may be bench operated or rack mounted individually or in pairs using accessory rack mounting hardware.

Description—Triple Output Models

6235A

This compact, low-cost, three-in-one power supply is a handy addition to the lab bench where single or multiple voltages are needed for designing and testing breadboards and prototypes. The Hewlett-Packard Model 6235A delivers three adjustable dc output voltages: 0 to +6 V at 1 A, 0 to +18 V at 0.2 A, and 0 to -18 V at 0.2 A. A single 0 to 36 volt output at 0.2 A can also be obtained by connecting across the +18 V and -18 V terminals.

The controls, meter, and binding posts are conveniently arranged on the front panel. One voltage control simultaneously adjusts the +18 V and -18 V outputs, which track one another and can be used to power operational amplifiers and other circuits requiring balanced positive and negative voltages. The supply's dual outputs have added versatility with an adjustable tracking ratio control (TRACK) that can set the negative output to a lower voltage than the positive output. Once the tracking ratio control has established a voltage ratio between the positive and negative outputs, the ratio remains constant as the +18 V voltage control is adjusted. A third control sets the 0 to +6 V output voltage.

The supply is a constant voltage/current limit type with each output voltage continuously adjustable over its range, while the maximum current available is automatically limited to prevent overloading. The power supply's outputs share a common terminal and are isolated from chassis ground so that any output terminal can be grounded if desired. Each output voltage or current can be quickly selected and monitored with the push-button meter switches.

Model 6235A measures 89 H x 157 W x 210 mm D (3.5" x 6.17" x 8.25") and weighs 2.3 kg (5 lb).

6236B and 6237B

Microprocessors, digital and linear integrated circuits, and displays used in lab development frequently require triple output power supplies for operating prototypes. The 6236B and 6237B are valued additions to the design bench due to their multiple output voltages, small size, ease of operation and application-related performance.

These compact constant voltage/current limiting supplies combine 0 to ± 20 V tracking outputs rated at 0.5 amps with a single output rated at 0 to +6 volts at up to 2.5 amps in the 6236B, and 0 to +18 volts at 1 amp in the 6237B.

Controls, meters, and binding posts are logically arranged on a neatly laid out front panel. One voltage control simultaneously adjusts the 20 V and -20 V outputs, which track within 1% to power operational amplifiers and circuits requiring balanced voltages. A tracking ratio control can disable the 1:1 tracking feature and set the negative output to a lower voltage than that of the positive output. Once the tracking ratio control has established a voltage ratio between the positive and negative outputs, the ratio remains constant as the ± 20 V voltage control varies both outputs. Another voltage control sets the 0 to +6 V (6236B) or 0 to +18 V (6237B) output.

All outputs are protected against overload and short-circuit damage by fixed current limiting circuits. For any overload condition, the +20 V and -20 V outputs in both models are limited to 0.55 amps and the +18 V output in the 6237B is limited to 1.1 amps. The overload protection circuit for the +6 V output in the 6236B has a current foldback characteristic that reduces the maximum available current from about 2.75 amps at a 6 V terminal voltage to 1 amp at zero volts (or short circuited). This foldback limiting characteristic maximizes the available current in the important 5 to 6-volt range while minimizing dissipation during overloads.

Another protective feature safeguards sensitive load circuitry by preventing an output voltage overshoot when the supply is turned on or off.

Separate dual-range panel meters allow both the voltage and current of any output to be monitored simultaneously. A three-position switch selects the output which the meters will monitor.

Both models measure only 89 H x 216 W x 319 mm D (3.5" x 8.5" x 12.5") and weigh 4.3 kg (9.5 lb).



Specifications

RATINGS		PERFORMANCE							GENERAL	
DC Output		Model	Load Effect	Source Effect	PARD rms/p-p	Control Mode and Resolution	Remote Control Coefficients	Power* 115 V ac \pm 10%	Options	
Volts	Amps									
SINGLE OUTPUT—10 WATTS										
0-10	0-1	6214B	4 mV	4 mV	200 μ V/1 mV	CV/CC 5mV/75 μ A	**	48-440 Hz 0.3 A, 28 W	28	
0-25	0-0.4	6216B	4 mV	4 mV	200 μ V/1 mV	CV/CC 5mV/20 μ A	**	48-440 Hz 0.3 A, 28 W	28	
0-50	0-0.2	6218B	4 mV	4 mV	200 μ V/1 mV	CV/CC 10mV/10 μ A	**	48-440 Hz 0.3 A, 28 W	28	
0-100	0-0.1	6212B	8 mV	4 mV	200 μ V/1 mV	CV/CC 20mV/1.0 μ A	**	48-440 Hz 0.3 A, 28 W	28	
SINGLE OUTPUT—UP TO 30 WATTS										
0-7.5	0-3	6203B	5 mV	3 mV	200 μ V/1 mV	CV/CC 5 mV/2 mA	200 Ω /V \pm 1% 500 Ω /A \pm 10%	48-440 Hz 0.9 A, 70 W	11, 28	
Dual range 0-20 or 0-40	0-1.5 0-0.75	6200B	0.01% + 4 mV	0.01% + 4 mV	200 μ V/1 mV	CV/CC 10 mV/2 mA	200 Ω /V \pm 1% 0.5 k Ω /A \pm 10% or 1 k Ω /A \pm 10%	48-440 Hz 0.9 A, 70 W	11, 28	
Dual range 0-30 or 0-60	0-1 0-0.5	6206B	0.01% + 4 mV	0.01% + 4 mV	200 μ V/1 mV	CV/CL 10 mV/*	300 Ω /V \pm 1%	48-440 Hz 1 A, 66 W	11, 28	
0-160	0.2	6207B	0.02% + 2 mV	0.02% + 2 mV	500 μ V/40 mV	CV/CC 25 mV/500 μ A	300 Ω /V \pm 1% 75 k Ω /A \pm 10%	48-63 Hz 1 A, 60 W	28	
0-320	0-0.1	6209B	0.02% + 2 mV	0.02% + 2 mV	1 mV/40 mV	CV/CC 40 mV/200 μ A	300 Ω /V \pm 1% 150 k Ω /A \pm 10%	48-63 Hz 1 A, 60 W	28	
DUAL OUTPUT—10 WATTS										
Dual output 0-25 and 0-25	0.2 0.2	6234A	0.01% + 1 mV	0.01% + 1 mV	200 μ V/1 mV	CV/CL	**	104-127 Vac 47-63 Hz 0.26A, 35 W	28	
DUAL OUTPUT—24 WATTS										
Two dual ranges 0-20/0-40 and 0-20/0-40	0-0.6/0.3 0-0.6/0.3	6205C	0.01% + 4 mV	0.01% + 4 mV	200 μ V/1 mV	CV/CL 10 mV/*	200 Ω /V \pm 1%	48-440 Hz 0.5 A, 50 W	11, 28 40	
TRIPLE OUTPUT—13 WATTS										
Triple output 0 to 6 and 0 to 18 and 0 to -18	0-1 0-0.2 0-0.2	6235A	8 mV 10 mV 10 mV	8 mV 15 mV 15 mV	1 mV/5 mV 1 mV/5 mV 1 mV/5 mV	CV/CL	** ** **	47-63 Hz 0.26 A, 35 W	28	
TRIPLE OUTPUT—35 WATTS										
Triple output 0 to +6 and 0 to +20 and 0 to -20	2.5 0.5 0.5	6236B	0.01% + 2 mV	0.01% + 2 mV	350 μ V/1.5 mV	CV/CL 70 mV/*	**	104-127 Vac 47-63 Hz 1.2 A, 112 W	100 220 240	
TRIPLE OUTPUT—38 WATTS										
Triple Output 0 to +18 and 0 to +20 and 0 to -20	1 0.5 0.5	6237B	0.01% + 2 mV	0.01% + 2 mV	350 μ V/1.5 mV	CV/CL 70 mV/*	**	104-127 Vac 47-63 Hz 1.2 A, 112 W	100 220 240	

*fixed current limit

**remote control not available

Option Descriptions

011: internal overvoltage protection crowbar. Protects delicate loads against power supply failure or operator error. Dual output models have dual crowbars.

6200B, 6203B, 6206B
6205C

028: 230 V ac \pm 10%, single phase input. Consists of reconnecting power transformer taps, and other components where necessary.

040: Multiprogrammer interface. Prepares 6205C power supplies for resistance programming by the 6940B or 6942A Multiprogrammer

100: 87-106 Vac, 47-63 Hz, single phase input
220: 191-233 Vac, 47-63 Hz, single phase input
240: 208-250 Vac, 47-63 Hz, single phase input
910: one additional operating and service manual is shipped with each power supply
 6200B-6237B

Accessories

14513A: rack kit for one 6200-6209B, 6236B, or 6237B supply

14523A: rack kit for two of the above power supplies

14521B: rack kit for one, two or three 6212B-6218B power supplies



POWER SUPPLIES

General Purpose: 25–200 W Output

Models 6227B–6299A

- Constant voltage/constant current operation
- Remote sensing and programming
- Auto-series, -parallel, & -tracking operation

- Front and rear output terminals
- Floating output—use as positive or negative source
- Bench or rack mounting

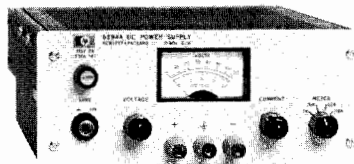

6281A, 6284A, 6289A,
6294A, 6299A

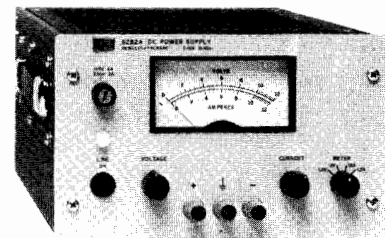

6282A, 6286A,
6291A, 6296A

Description

6281A–6299A Single Output

This series of medium-power constant voltage/constant current power supplies is available in two power ranges: 37–75 watts (packaged in 3½-inch high half-rack cases), and 100–200 watts (packaged in 5½-inch high half-rack cases). All models except 6294A and 6299A have separate coarse and fine voltage and current controls that allow the voltage and current outputs to be varied from zero to the maximum rated values. The latter two models have ten-turn voltage controls. Crossover from constant voltage to constant current operation occurs automatically when the load current exceeds the value established by the current control settings. A four-position meter function switch selects either of two output voltage or output current ranges (X1, X0.1) for display on the panel meter.

The 37–75 watt models are of the series-regulated type. They have excellent regulation and ripple characteristics and include a special output-capacitor discharge circuit for improved programming speed. The 100–200 watt models employ a series-regulator/SCR-preregulator configuration to achieve the high efficiency necessary for a convection-cooled package of this size. They also have excellent regulation, low ripple and noise, and moderate programming speeds.

6253A and 6255A Dual Output

These versatile dual-output models each contain two identical, independently adjustable 60 watt power supplies in a full-rack width case. The regulator, voltage and current control, and metering circuits of each section of the supply are electrically identical to those of the individual 37–75 watt models described above.

By combining the versatility of a dual power supply with the flexibility of auto-series and auto-parallel operation, twice the maximum rated output voltage or current of each section can be obtained from the one supply. In addition, using the supply's auto-tracking capability, opposite-polarity voltages (± 20 V for Model 6253A or ± 40 V for Model 6255A) are possible.

6227B and 6228B Dual Output

These versatile lab supplies each house two identical 50 W regulated power supplies. A convenient front panel switch selects either independent or tracking operation. In the track mode, the right supply tracks the left within $0.2\% \pm 2$ mV. The tracking mode is especially useful for powering operational amplifiers, push-pull stages, deflection systems, or any application where plus and minus voltages must track with insignificant error. The independent mode permits operation of the two supplies individually, in auto-parallel or in auto-series.

Specifications

RATINGS			PERFORMANCE							
DC Output		Model	Load Effect		Source Effect		PAR (rms/p-p)		Drift (stability)	
Volts	Amps		Voltage	Current	Voltage	Current	Voltage	Current	Voltage	Current
0–7.5	0–5	6281A	5 mV	0.01% + 250 μ A	0.01% + 2 mV	0.01% + 250 μ A	200 μ V/1 mV	4 mA rms	0.1% + 2.5 mV	0.1% + 12.5 mA
0–10	0–10	6282A	0.01% + 1 mV	0.05% + 1 mA	0.01% + 1 mV	0.05% + 1 mA	500 μ V/25 mV	5 mA rms	0.1% + 2.5 mV	0.1% + 25 mA
0–20 0–20	0–3 0–3	6253A*	0.01% + 4 mV	0.01% + 250 μ A	0.02% + 2 mV	0.01% + 250 μ A	200 μ V/1 mV	2 mA rms	0.1% + 2.5 mV	0.1% + 7.5 mA
0–20	0–3	6284A	0.01% + 4 mV	0.01% + 250 μ A	0.01% + 2 mV	0.01% + 250 μ A	200 μ V/1 mV	2 mA rms	0.1% + 2.5 mV	0.1% + 7.5 mA
0–20	0–10	6286A	0.01% + 1 mV	0.05% + 1 mA	0.01% + 1 mV	0.05% + 1 mA	500 μ V/25 mV	5 mA rms	0.1% + 2.5 mV	0.1% + 25 mA
0–25 0–25	0–2 0–2	6227B*	0.01% + 1 mV	0.01% + 250 μ A	1 mV	100 μ A	250 μ V/4 mV	250 μ A/2 mA	0.2% + 2 mV	0.2% + 3 mA
0–40 0–40	0–1.5 0–1.5	6255A*	0.01% + 2 mV	0.01% + 250 μ A	0.01% + 2 mV	0.01% + 250 μ A	200 μ V/1 mV	500 μ A rms	0.1% + 2.5 mV	0.1% + 4 mA
0–40	0–1.5	6289A	0.01% + 2 mV	0.01% + 250 μ A	0.01% + 2 mV	0.01% + 250 μ A	200 μ V/1 mV	500 μ A rms	0.1% + 2.5 mV	0.1% + 4 mA
0–40	0–5	6291A	0.01% + 1 mV	0.05% + 1 mA	0.01% + 1 mV	0.05% + 1 mA	500 μ V/25 mV	3 mA rms	0.1% + 2.5 mV	0.1% + 12.5 mA
0–50 0–50	0–1 0–1	6228B*	0.01% + 1 mV	0.01% + 250 μ A	1 mV	100 μ A	250 μ V/4 mV	250 μ A/2 mA	0.2% + 2 mV	0.2% + 1.5 mA
0–60	0–1	6294A	0.01% + 2 mV	0.01% + 250 μ A	0.01% + 2 mV	0.01% + 250 μ A	200 μ V/1 mV	500 μ A rms	0.1% + 2.5 mV	0.1% + 2.5 mA
0–60	0–3	6296A	0.01% + 1 mV	0.05% + 1 mA	0.01% + 1 mV	0.05% + 1 mA	500 μ V/25 mV	3 mA rms	0.1% + 2.5 mV	0.1% + 7.5 mA
0–100	0–0.75	6299A	0.01% + 2 mV	0.01% + 250 μ A	0.01% + 2 mV	0.01% + 250 μ A	200 μ V/1 mV	500 μ A rms	0.1% + 2.5 mV	0.1% + 2 mA

*Models 6227B, 6228B, 6253A, and 6255A contain two identical, independently-adjustable power supplies.

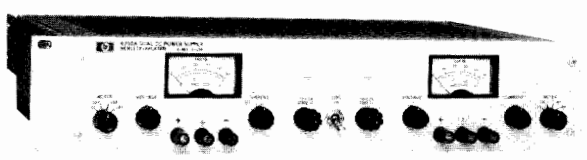

6253A, 6255A

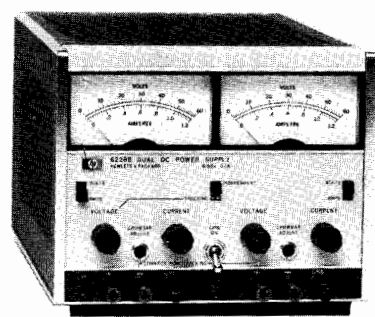

6227B, 6228B

Each side of the dual supply can be operated as a constant voltage or constant current source, and each has its own crowbar for overvoltage protection. In the tracking mode, an overvoltage condition in either supply trips both crowbars. The power supply outputs are isolated up to 300 V from output to chassis or output to output.

Specifications—General

Load effect transient recovery: time, 50 μ s. Level, 15 mV.
Meter accuracy: 3% of full scale.
Power: standard input voltage is 115 V ac \pm 10%. Order Option 028 for 230 V ac \pm 10% operation. Input power frequency, maximum input current, maximum power consumption are:
 6227B and 6228B, 48–63 Hz, 2.7 A, 260 W;
 6253A, 48–440 Hz, 2.6 A, 235 W; 6255A, 48–440 Hz, 2.6 A, 235 W;
 6281A, 48–440 Hz, 1.3 A, 118 W; 6282A, 57–63 Hz, 3.5 A, 200 W;
 6284A, 48–440 Hz, 1.5 A, 128 W; 6286A, 57–63 Hz, 5.5 A, 320 W;
 6289A, 48–440 Hz, 1.3 A, 110 W; 6291A, 57–63 Hz, 5.5 A, 280 W;
 6294A, 48–440 Hz, 1.3 A, 114 W; 6296A, 57–63 Hz, 4.5 A, 250 W;
 6299A, 48–440 Hz, 1.5 A, 135 W.
Size: 6227B, 6228B: 155 H x 197 W x 309.55 mm D (6³/₃₂" x 7²⁵/₃₂" x 12¹/₁₆").
 6253A, 6255A: 87 H x 483 W x 403 mm D (3¹/₁₆" x 19" x 15⁷/₁₆").
 6281A, 6284A, 6289A, 6294A, 6299A: 87 H x 209 W x 398 mm D (3³/₁₆" x 8⁷/₃₂" x 15³/₁₆").
 6282A, 6286A, 6291A, 6296A: 131 H x 210 W x 435 mm D (5¹/₃₂" x 8¹/₄" x 17¹/₈").

Option Descriptions

005: 50 Hz ac input: optimizes power supplies that require adjustment/modification for 50 Hz operation.
010: Chassis slides. Enable convenient access to rack-mounted power supply for maintenance

011: Internal overvoltage protection crowbar. Protects sensitive loads against power supply failure or operator error. Monitors the output voltage and places a virtual short circuit (conducting SCR) across load after preset trip voltage is exceeded.

6281A, 6284A, 6289A, 6294A, 6299A
 6282A, 6286A, 6291A, 6296A
 6253A, 6255A
028: 230 V ac \pm 10%, single-phase input. Factory modification reconnects the multi-tap input power transformer for 230 V operation.
040: Interfacing for Multiprogrammer operation. Prepares standard HP power supplies for resistance programming by the HP 6940B or 6942A. Price per output.
910: one additional operating and service manual shipped with the power supply
 6253A, 6255A, 6227B, 6228B
 6281A, 6282A, 6284A, 6286A, 6289A, 6291A, 6294A, 6296A, 6299A

Accessories

14513A: 3.5 in. high rack kit for one 6281A, 6284A, 6289A, 6294A, 6299A
14523A: 3.5 in. high rack kit for two above supplies
14515A: 5.25 in. high rack kit for one 6282A, 6286A, 6291A, 6296A
14525A: 5.25 in. high rack kit for two above supplies
5060-8760: blank filler panel for 6227B, 6228B
5060-8762: adapter frame for rack mounting one or two 6227B, 6228B

Specifications, continued

REMOTE CONTROL FEATURES								GENERAL				
Resistance Coefficient		Voltage Coefficient		Speed, UP*		Speed, DOWN*		Overvoltage		Weight		Options [▲]
Voltage	Current	Voltage	Current	NL	FL	NL	FL	Range	Margin	Net	Shipping	
200 Ω /V \pm 1%	200 Ω /A \pm 10%	1 V/V \pm 1%	0.2 V/A \pm 10%	1 ms	2 ms	10 ms	6 ms	2.5–10 V	4% + 2 V	6.4 kg/14 lb	7.2 kg/16 lb	11, 28, 40
200 Ω /V \pm 1%	100 Ω /A \pm 10%	1 V/V \pm 1%	100 mV/A \pm 10%	70 ms	200 ms	9 s	40 ms	1–13 V	7% + 1 V	11.3 kg/25 lb	13.6 kg/30 lb	5, 11, 28, 40
200 Ω /V \pm 1%	500 Ω /A \pm 10%	1 V/V \pm 1%	0.33 V/A \pm 10%	30 ms	80 ms	400 ms	100 ms	2.5–23 V	4% + 2 V	12.7 kg/28 lb	17.7 kg/39 lb	10, 11, 28, 40
200 Ω /V \pm 1%	500 Ω /A \pm 10%	1 V/V \pm 1%	0.33 V/A \pm 10%	30 ms	80 ms	400 ms	100 ms	2.5–23 V	4% + 2 V	6.4 kg/14 lb	7.2 kg/16 lb	11, 28, 40
200 Ω /V \pm 1%	100 Ω /A \pm 10%	1 V/V \pm 1%	100 mV/A \pm 10%	150 ms	150 ms	9 s	70 ms	2–22 V	7% + 1 V	10.8 kg/26 lb	13.1 kg/29 lb	5, 11, 28
200 Ω /V \pm 1%	500 Ω /A \pm 10%	1 V/V \pm 1%	.5 V/A \pm 10%	40 ms	200 ms	400 ms	75 ms	5–28 V	7% + 1.5 V	11 ka/24 lb	12.9 kg/28 lb	40
200 Ω /V \pm 1%	500 Ω /A \pm 10%	1 V/V \pm 1%	0.66 V/A \pm 10%	15 ms	45 ms	200 ms	40 ms	2.5–44 V	4% + 2 V	12.7 kg/28 lb	17.7 kg/39 lb	10, 11, 28, 40
200 Ω /V \pm 1%	500 Ω /A \pm 10%	1 V/V \pm 1%	0.66 V/A \pm 10%	15 ms	45 ms	200 ms	40 ms	2.5–44 V	4% + 2 V	6.4 kg/14 lb	7.2 kg/16 lb	11, 28, 40
200 Ω /V \pm 1%	200 Ω /A \pm 10%	1 V/V \pm 1%	200 mV/A \pm 10%	275 ms	275 ms	13 s	275 ms	6–43 V	7% + 1 V	11.3 kg/25 lb	12.7 kg/28 lb	5, 11, 28
200 Ω /V \pm 1%	1 k Ω /A \pm 10%	1 V/V \pm 1%	1 V/A \pm 10%	50 ms	350 ms	1 s	50 ms	5–55 V	7% + 1.5 V	11 ka/24 lb	12.9 kg/28 lb	40
300 Ω /V \pm 1%	1 k Ω /A \pm 10%	1 V/V \pm 1%	1 V/A \pm 10%	25 ms	80 ms	2 s	175 ms	5–65 V	4% + 2 V	5.9 kg/13 lb	6.8 kg/15 lb	11, 28, 40
300 Ω /V \pm 1%	500 Ω /A \pm 10%	1 V/V \pm 1%	333 mV/A \pm 10%	600 ms	600 ms	5 s	200 ms	9–66 V	7% + 1 V	11.3 kg/25 lb	12.7 kg/28 lb	5, 11, 28
300 Ω /V \pm 1%	1 k Ω /A \pm 10%	1 V/V \pm 1%	1.3 V/A \pm 10%	25 ms	200 ms	1.5 s	200 ms	20–106 V	4% + 2 V	5.9 kg/13 lb	6.8 kg/15 lb	11, 28, 40

*UP = increasing output voltage. NL = No output load current. FL = Full rated output load current.



POWER SUPPLIES

General Purpose: Autoranging—200 & 1000 W Output

Models 6012A and 6024A

- Autoranging output
- High efficiency, compact and lightweight
- Fast remote programming

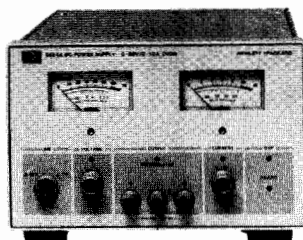

6024A—200 watts

Autoranging Power Supply Description

The model 6012A and 6024A set a new technological standard for laboratory and system dc power supplies. They are the first in a new generation of power supplies from Hewlett-Packard, combining state of the art advances in both component and circuit design. The result is increased performance and flexibility and friendlier operation both on the bench and in automated test and control systems.

Conventional dc power supplies have an output characteristic which is described by a rectangle. The flexibility provided by an autoranging power supply is revealed when its output characteristic is compared to that of a conventional supply. A conventional power supply can provide its maximum output power at only one combination of voltage and current. Autoranging power supplies provided maximum output power capability over a wide and continuous range of voltage or current. This function is performed automatically, requiring no range selection by the operator.

Using the model 6024A as an example, you would have to combine a 20-volt 10-amp supply, a 40-volt 5-amp supply, and a 60-volt 3-amp supply in order to approximate the same capability as the 6024A. (See output curves on next page.) The autoranging feature of these power supplies makes them convenient and cost-effective units capable of satisfying many different dc requirements.

In the Lab

Both models have many features that make them versatile. Mode indicators, adjustable overvoltage protection, 10-turn pots, amplified current monitor, and voltage and current meters are some of the features. A barrier strip at the rear of the supply provides the necessary terminals for current monitoring, remote programming, and remote sensing.

In auto-parallel operation, up to three units of the same model may be connected in parallel to increase the total output current capability while maintaining control from one master power supply. In auto-series operation up to four units may be connected in series to increase the total output voltage to 240 V while maintaining control from one master power supply.

Several LEDs on the front panel indicate the operating status without any additional measurement or control changes. Two 10-turn potentiometers on the front panel provide high resolution control of output voltage and current. A secondary scale on the voltmeter indicates maximum "Amperes Available". Likewise, the ammeter has a secondary scale to indicate the "Volts Available". The secondary scales are calibrated to follow the maximum output power curve and let the user know approximately how much power margin is available at any operating point.

Because of the delicate nature of many loads several types of protection have been included. When operating in constant-voltage mode, a current limit can be set. Similarly, when operating in constant-current mode, a voltage limit can be set.

In the System

System designers frequently need a variety of fixed and programmable power supplies. By standardizing on autoranging power supplies, the system designer can reduce the number of different models required along with their resultant documentation and support.

- Designed for system applications
- Ten-turn voltage and current controls
- Operating mode status indicators

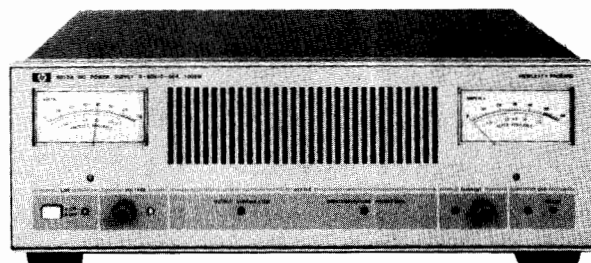

6012A—1000 watts

The standard models can be programmed either with a resistance or a voltage input. Full scale output voltage and current have been normalized to 2500 ohms or 5.0 volts. Both models contain an active down programming circuit. This circuit provides an improvement of up to 15 to 1 in down programming speed over conventional power supplies of similar ratings. Sensing terminals are provided at the rear of the power supply for applications where the load may be located some distance from the supply. When using remote sensing, the power supply maintains regulation at the load rather than at the rear terminals of the supply. The amplified current monitor provides a 0–5 volt output which is directly proportional to the output current.

Some of the most important benefits of using these supplies in systems results from the switching technology employed. A switching frequency of 20 kHz is used which allows most power handling components, as well as the filter capacitors, to be substantially reduced in size. This contributes to the reduced size and weight of the supply. Typical operating efficiency is 75%, which reduces the amount of cooling necessary for the overall system and enables the system to use less power.

Option 002

The optional interface (002) provides a convenient means of integrating these supplies into a custom designed system or one controlled by an HP Multiprogrammer. A 69520A programmer card in conjunction with the option 002 card allows these supplies to be controlled by a 6940B Multiprogrammer. Similarly, the model 69709A programmer card is required when controlling the power supply by a 6942A Multiprogrammer.

The interface features are available through a 37-pin connector on the back of the power supply, and include:

Remote programming: both the output voltage and current can be remotely programmed. In addition to external voltage and resistance programming, the interface provides current programming of output voltage and current.

Status readback: six optically isolated status lines provide digital outputs to indicate the following states: constant-voltage, constant-current, unregulated output, ac line fault, overtemperature, and over-voltage.

Remote shutdown: there are two methods to remotely disable the output. The first method, utilizing two inputs, allows one input to be pulse "set" and the other to be pulse "reset." The second method uses one input whose level determines the output condition. These input lines are TTL compatible and optically isolated to prevent ground loops.

Output bias supplies: three bias supplies are available with +5V, +15V, and –15V to power DAC's and other user supplied circuitry.

Voltage and current readback: for convenience, both are brought through the option connector.

DC Output

	Voltage	0-60 V	0-60 V
	Current	0-10 A	0-50 A
Model		6024A	6012A
Load effect: (Load regulation)	Voltage	0.01% +3 mV	0.01% +5 mV
	Current	0.01% +3 mA	0.01% +5 mA
Source effect: (Line regulation)	Voltage	0.01% +2 mV	0.01% +3 mV
	Current	0.01% +2 mA	0.01% +5 mA
PARD: (Ripple and noise) rms/p-p, 20 Hz to 20 MHz	Voltage	3 mV/ 30 mV	5 mV/50 mV
	Current	5 mA rms	25 mA rms
Temperature coefficient: Δ/°C after 30 minute warmup	Voltage	0.01% +1 mV	0.01% +2 mV
	Current	0.03% +1 mA	0.01% +3 mA
Drift: (Stability) change in output over an 8 hour interval	Voltage	0.03% +3 mV	0.03% +5 mV
	Current	0.03% +3 mA	0.03% +5 mA
Load effect transient recovery response:	Time	1 ms	2 ms
	Level	75 mV	100 mV
	Resolution: (Minimum adjustment of front panel controls)	Voltage	20 mV
	Current	5 mA	20 mA
Remote resistance programming accuracy: (2500 ohms necessary for full scale output)	Voltage	0.08% +1 mV	1% +3 mV
	Current	2.4% +1 mA	2.5% +10 mA
Remote voltage programming accuracy: (5.0 volts necessary for full scale output)	Voltage	0.2% +1 mV	0.3% +3 mV
	Current	0.9% +1 mA	1% +10 mA
Programming response time: Maximum time for output voltage to change from 2 V to 60 V or 60 V to 2 V and settle within 200 mV	Up full load	200 ms	120 ms
	Up no load	200 ms	120 ms
	Down full load	300 ms	400 ms
	Down no load	600 ms	1.2 s
Overvoltage trip point range:		2-63 V	2-63 V
Amplified current monitor: 0-5 V represents zero to rated current output	Accuracy	0.9% +7 mV	1% +10 mV
	Output impedance	10 KΩ nom.	10 KΩ nom.
	RFI specifications:	Meets VDE 0871/6.78 Level A	
Safety specifications:	Comply with IEC 348, VDE 0411, CSA 556B, CSA 22.2 #0-1975		
DC output isolation:	± 240 Vdc from ground		
Temperature rating: (fan cooled)	Operating	0-55°C	
	Storage	-40 to +75°C	
AC input: (48-63 Hz) (Standard)	Voltage	104-127 Vac	
	Current	5.3 A rms max.	24 A rms max.
Weight:	Net	5.4 Kg (12 lbs)	15 Kg (33 lbs)
	Shipping	7.3 Kg (16 lbs)	16 Kg (35 lbs)

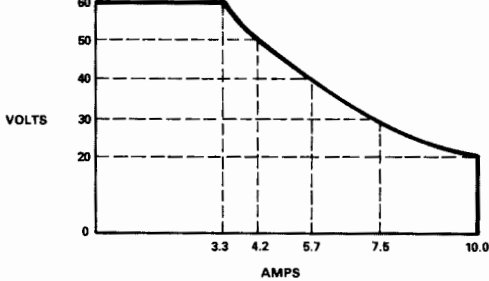

Autoranging operating area for the 6024A

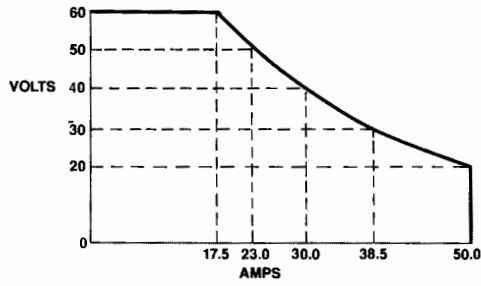

Autoranging operating area for the 6012A

Ordering Information

- 6024A** Autoranging Power Supply
Options
002: System interface
100: 87-106 Vac, 48-63 Hz (For use in Japan only. 150W maximum output power)
220: 191-233 Vac, 48-63 Hz
240: 208-250 Vac, 48-63 Hz
907: Front handle kit (p/n 5061-0089)
908: Rack flange kit (p/n 5061-0057) for single product system installation
910: Extra operating and service manual (p/n 06024-90001)

6012A Autoranging Power Supply

- Options**
002: System Interface
100: 87-106 Vac, 48-63 Hz (For use in Japan only. 150W maximum output power)
220: 191-233 Vac, 48-63 Hz
240: 208-250 Vac, 48-63 Hz
907: Front handle kit (p/n 5061-0089)
908: Rack flange kit (p/n 5061-0077)
909: Combination of Option 907 front handle kit and Option 908 rack flange kit
910: Extra operating and service manual (p/n 06024-90001)

Accessories

- 5061-0094:** Cabinet lock-together kit to connect two 6024As
5061-0077: Rack flange kit to mount two locked 6024As

System Interface Specifications

		6024A	6012A
Sink current necessary for full scale output of voltage:	Voltage	2 mA	2mA
	Accuracy	0.3% + 7 mV	0.4% + 9 mV
Sink current necessary for full scale output of current:	Current	2 mA	2 mA
	Accuracy	1% + 2 mA	1.1% + 15 mA
Isolation: (Between status and control lines equipment ground, and power supply output)	Voltage	600 Vdc	600 Vdc

Multiprogrammer Interface Cards

Model 69520A (for 6940B Multiprogrammer)			
Programming resolution	Voltage	60 mV	60 mV
	Current	10 mA	50 mA
Model 69709A (for 6942A Multiprogrammer)			
Programming Resolution	Voltage	60 mV	60 mV
	Current	10 mA	50 mA

POWER SUPPLIES

General Purpose: 120-2000 W Output

Models 6259B-6274B & 895A

- Built-in overvoltage protection*
- Constant voltage/constant current operation
- Remote programming and sensing

- Remote sensing
- Auto-series, -parallel, and -tracking operation
- ≤ 50 μ s load transient recovery

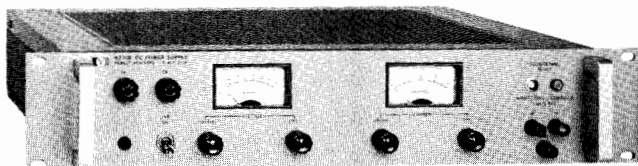

6263B, 6266B, 6271B

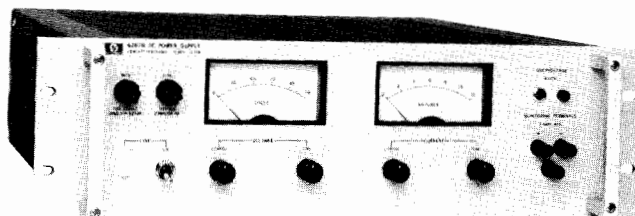

6264B, 6267B

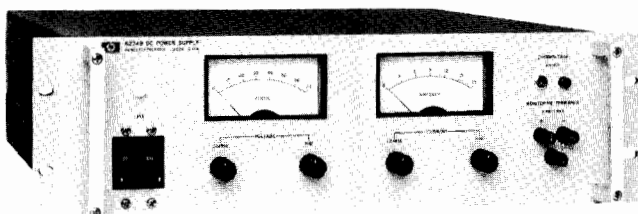

6274B

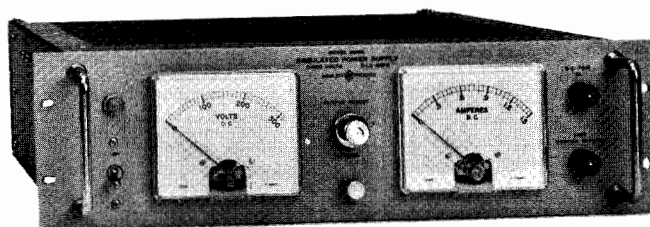

895A

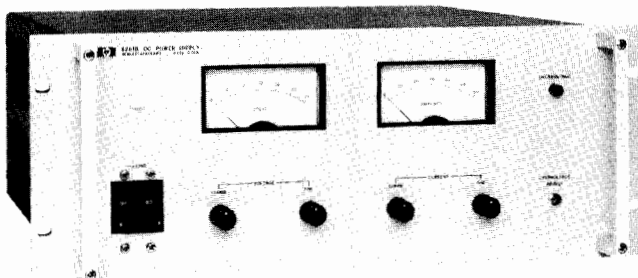

6259B, 6260B, 6261B, 6268B, 6269B

Description

Models 6259B-6274B

This series of high-performance constant voltage/constant current supplies includes twelve models with output rating from 10 to 60 V. All models employ a transistor series-regulator/triac-preregulator circuit to achieve high efficiency, excellent regulation, low ripple and noise, and moderate programming speeds in a compact full-rack width package.

Separate coarse and fine voltage and current controls allow the voltage and current outputs to be varied from zero to the maximum rated value, crossover from constant voltage to constant current operation occurs automatically when the load current exceeds the value established by the current control settings.

Additional features include built-in overvoltage crowbar protection; remote error sensing; and auto-series, auto-parallel, and auto-tracking operation. The crowbar trip point adjustment and associated overvoltage indicator are conveniently located on the front panel.

Specifications†

RATINGS			PERFORMANCE							
DC Output		Model	Load Effect		Source Effect		PAR (rms/p-p)		Drift (stability)	
Volts	Amps		Voltage	Current	Voltage	Current	Voltage	Current	Voltage	Current
0-10	0-50	6259B	0.01% + 200 μ V	0.02% + 1 mA	0.01% + 200 μ V	0.02% + 1 mA	500 μ V/5 mV	25 mA rms	0.03% + 2 mV	0.03% + 10 mA
0-10	0-100	6260B	0.01% + 200 μ V	0.02% + 2 mA	0.01% + 200 μ V	0.02% + 2 mA	500 μ V/5 mV	50 mA rms	0.03% + 2 mV	0.03% + 20 mA
0-20	0-10	6263B	0.01% + 200 μ V	0.02% + 500 μ A	0.01% + 200 μ V	0.02% + 500 μ A	200 μ V/10 mV	3 mA rms	0.03% + 500 μ V	0.03% + 6 mA
0-20	0-20	6264B	0.01% + 200 μ V	0.02% + 500 μ A	0.01% + 200 μ V	0.02% + 500 μ A	200 μ V/10 mV	5 mA rms	0.03% + 500 μ V	0.03% + 6 mA
0-20	0-50	6261B	0.01% + 200 μ V	0.02% + 1 mA	0.01% + 200 μ V	0.02% + 1 mA	500 μ V/5 mV	25 mA rms	0.03% + 2 mV	0.03% + 10 mA
0-40	0-5	6266B	0.01% + 200 μ V	0.02% + 500 μ A	0.01% + 200 μ V	0.02% + 500 μ A	200 μ V/10 mV	3 mA rms	0.03% + 500 μ V	0.03% + 3 mA
0-40	0-10	6267B	0.01% + 200 μ V	0.02% + 500 μ A	0.01% + 200 μ V	0.02% + 500 μ A	200 μ V/10 mV	3 mA rms	0.03% + 2mV	0.03% + 3 mA
0-40	0-30	6268B	0.01% + 200 μ V	0.02% + 2 mA	0.01% + 200 μ V	0.02% + 2 mA	1 mV/5 mV	20 mA rms	0.03% + 2 mV	0.03% + 5 mA
0-40	0-50	6269B	0.01% + 200 μ V	0.02% + 2 mA	0.01% + 200 μ V	0.02% + 2 mA	1 mV/5 mV	25 mA rms	0.03% + 2 mV	0.03% + 10 mA
0-60	0-3	6271B	0.01% + 200 μ V	0.02% + 500 μ A	0.01% + 200 μ V	0.02% + 500 μ A	200 μ V/10 mV	3 mA rms	0.03% + 500 μ V	0.03% + 3 mA
0-60	0-15	6274B	0.01% + 200 μ V	0.02% + 500 μ A	0.01% + 200 μ V	0.02% + 500 μ A	200 μ V/20 mV	5 mA rms	0.03% + 2 mV	0.03% + 5 mA
0-320	0-1.5	895A	0.007% or 20 mV	—	0.007% or 20 mV	—	1 mV rms	—	0.1% + 5 mV	—

*These six features apply to models 6259B-6274B, but not to model 895A.

†Refer to page 226 for complete specification definitions.

Auto-series, auto-parallel, and auto-tracking connections should ordinarily include no more than three supplies. If a specific application requires the use of more than three supplies in any of the three connections, consult your local HP Field Engineer for additional information.

All dc output, ac input, sensing, control, and programming connections are made to rear-panel terminals. Either the positive or negative output terminal may be grounded or the supplies may be operated floating at up to 300 volts above ground. Models 6263B, 6264B, 6266B, 6267B, and 6271B are convection cooled. All other models in this series employ cooling fans. Models which output more than 200 watts are equipped with terminal blocks for ac input and are not shipped with line cords.

Model 895A

Model 895A is a general purpose constant/voltage/current/limit supply. Output voltage is adjustable from 0-320 V via a front panel 10-turn potentiometer with concentric lock and a single-turn fine control. Separate voltage and current meters provide continuous indication of power supply outputs. High performance specifications include 0.007% line and load regulation and 1 mV rms ripple and noise. Remote sensing and programming are standard features. The 895A is equipped with a terminal block for ac input and is not shipped with a line cord.

Specification—General

Load effect transient recovery: time—50 μ s. Level—10 mV (895A—time—100 μ s. Level—20 mV)

Resolution: voltage control—less than 0.02%. Current control—less than 0.15%.

Temperature coefficient per °C: 0.01% of output plus 200 μ V (895A—0.03% + 1.5 mV).

Temperature ratings: operating, 0 to 55°C; Storage, -40 to 75°C.

Remote control programming: these power supplies are capable of being programmed in constant voltage and constant current operation by using an external resistance or dc voltage with coefficients as shown in the table below.

Rear terminal wiring configurations for remote control operation are specified in the operating and service manual supplied with the power supply. For remote control programming procedures and timing considerations, contact your local HP field engineer.

Power: input voltage is 115 V ac or 230 V ac \pm 10%, 57-63 Hz. For other input voltage and frequency options available, see option listing below. Standard input voltage, maximum input current, and maximum power are:

- 6259B, 230 V ac, 6 A, 850 W;
- 6260B, 230 V ac, 12 A, 1600 W;
- 6261B, 230 V ac, 12 A 1500 W;
- 6263B, 115 V ac, 4.5 A, 350 W;
- 6264B, 115 V ac, 8 A, 600 W;
- 6266B, 115 V ac, 4 A, 325 W;
- 6267B, 115 V ac, 8 A, 550 W;
- 6268B, 230 V ac, 12 A, 1600 W;
- 6269B, 230 V ac, 18 A, 2500 W;
- 6271B, 115 V ac, 4 A, 300 W;
- 6274B, 115 V ac, 15 A, 1200 W;
- 895A, 115 V ac, 8.7 A, 585 W.

AC line connections: three wire, five foot ac power cord included—6263B, 6266B and 6271B.

Three terminal barrier strip provided on power supply for ac power connections—6259B, 6260B, 6261B, 6264B, 6267B, 6268B, 6269B, 2674B and 895A.

Size

6263B, 6266B, 6271B: 83.7 H x 483 W x 479.4 mm D (3.296" x 19" x 18.875").

6264B, 6267B, 6274B: 127 H x 483 W x 479.4 mm D (5.00" x 19" x 18.875").

6259B, 6260B, 6261B, 6268B, 6269B: 173 H x 483 W x 479.4 mm D; (6.812" x 19" x 18.875").

895A: 128.6 H x 483 W x 463.6 mm D (5.062" x 19" x 18.25").

Option Descriptions

005: 50 Hz ac input: optimizes power supplies that require adjustment/modification for 50 Hz operation.

010: chassis slides. For access to rack mounted power supplies. 6263B, 6264B, 6266B, 6267B, 6271B, 6274B 6259B, 6260B, 6261B, 6268B, 6269B

016: 115 V ac \pm 10% single phase input. Consists of replacing power transformer and circuit breaker, and reconnecting bias transformer, RFI choke and fans.

022: voltage and current programming adjust. Allows the V and I programming coefficients and zero output to be conveniently adjusted to 0.1% accuracy via access holes in the rear panel. Consists of four potentiometers and resistors located inside the rear panel.

026: 115 V ac \pm 10%, single phase input. Consists of replacing the input circuit breaker and reconnecting the power transformer, bias transformer, RFI choke, and fans.

027: 208 V ac, \pm 10%, single phase input. Consists of reconnecting power transformer taps, and other components where necessary.

028: 230 V ac \pm 10%, single phase input. Consists of reconnecting power transformer taps, and other components where necessary.

040: Multiprogrammer interface. Prepares standard HP power supplies for resistance programming by the 6942A or 6940B Multiprogrammers. This option includes Option 022, special calibration, and protection check-out procedures (where required).

910: one additional operating and service manual shipped with each power supply. 6259B-6274B 895A

J10: special option for 220 V 50 Hz operation for the 895A.

Specifications, Continued

REMOTE CONTROL FEATURES								GENERAL				
Resistance Coeff.		Voltage Coeff.		Speed Up*		Speed Down*		Overvoltage		Weight		Options
Voltage	Current	Voltage	Current	NL	FL	NL	FL	Range	Margin	Net	Shipping	
200 Ω /V \pm 1%	4 Ω /A \pm 10%	1 V/V \pm 1%	10 mV/A \pm 10%	70 ms	70 ms	200 ms	100 ms	2-12 V	5% + 2V	31.3 kg/69 lb	35.3 kg/78 lb	5, 10, 22, 26, 27, 40
200 Ω /V \pm 1%	2 Ω /A \pm 10%	1 V/V \pm 1%	5 mV/A \pm 10%	70 ms	70 ms	200 ms	75 ms	2-12 V	5% + 2V	43.9 kg/97 lb	48 kg/106 lb	5, 10, 16, 22, 27, 40
200 Ω /V \pm 1%	100 Ω /A \pm 10%	1 V/V \pm 1%	50 mV/A \pm 10%	150 ms	150 ms	7 s	350 ms	2-23 V	5% + 1 V	15.4 kg/34 lb	18.6 kg/41 lb	5, 10, 22, 27, 28, 40
200 Ω /V \pm 1%	10 Ω /A \pm 10%	1 V/V \pm 1%	25 mV/A \pm 10%	140 ms	140 ms	10 s	150 ms	2.5-23V	5% + 1 V	21.3 kg/47 lb	24.5 kg/54 lb	5, 10, 22, 27, 28, 40
200 Ω /V \pm 1%	4 Ω /A \pm 10%	1 V/V \pm 1%	10 mV/A \pm 10%	150 ms	150 ms	250 ms	250 ms	2-23 V	5% + 2V	35.3 kg/78 lb	39.4 kg/87 lb	5, 10, 22, 26, 27, 40
200 Ω /V \pm 1%	200 Ω /A \pm 10%	1 V/V \pm 1%	100 mV/A \pm 10%	275 ms	275 ms	13 s	1.5 s	2.5-45 V	5% + 1 V	15.4 kg/34 lb	18.6 kg/41 lb	5, 10, 22, 27, 28, 40
200 Ω /V \pm 1%	100 Ω /A \pm 10%	1 V/V \pm 1%	50 mV/A \pm 10%	275 ms	275 ms	13 s	750 ms	2.5-45 V	5% + 1 V	17.7 kg/39 lb	20.8 kg/46 lb	5, 10, 22, 27, 28, 40
200 Ω /V \pm 1%	6 Ω /A \pm 10%	1 V/V \pm 1%	16.7 mV/A \pm 10%	300 ms	300 ms	1 s	650 ms	4-45 V	5% + 1 V	34.4 kg/76 lb	38.1 kg/84 lb	5, 10, 22, 26, 27, 40
200 Ω /V \pm 1%	4 Ω /A \pm 10%	1 V/V \pm 1%	10 mV/A \pm 10%	350 ms	350 ms	1 s	600 ms	4-45 V	5% + 1 V	40.3 kg/89 lb	44 kg/98 lb	5, 10, 22, 27, 40
300 Ω /V \pm 1%	300 Ω /A \pm 10%	1 V/V \pm 1%	167 mV/A \pm 10%	600 ms	600 ms	7 s	2 s	6-66 V	5% + 1 V	15.4 kg/34 lb	18.6 kg/41 lb	5, 10, 22, 27, 28, 40
300 Ω /V \pm 1%	67 Ω /A \pm 10%	1 V/V \pm 1%	33.3 mV/A \pm 10%	600 ms	600 ms	40 s	800 ms	6-66 V	5% + 1 V	21.7 kg/48 lb	24.5 kg/54 lb	5, 10, 22, 27, 28, 40
300 Ω /V	—	—	—	—	—	—	—	NA	NA	22.6 kg/50 lb	29.4 kg/65 lb	J10

*Up = increasing output voltage. NL = No output load current. FL = Full rated output load current



POWER SUPPLIES

General Purpose: 300—11,000 W Output

Models 6434B—6483C

- Outstanding value—low cost/watt
- Up to 75% efficiency at full output
- Constant voltage/constant current operation

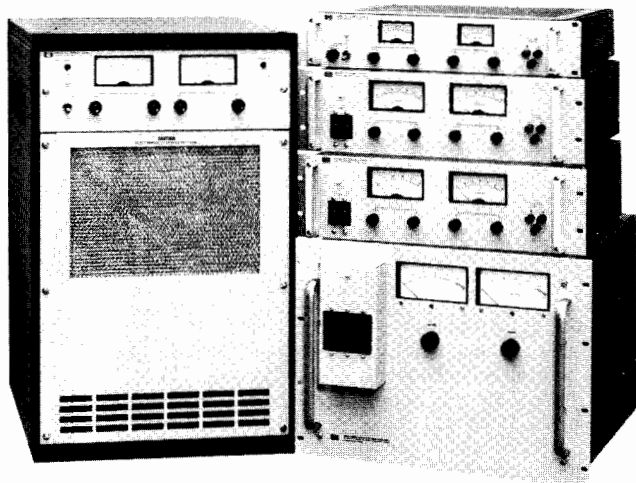

6434B—6483C

Description

This series of SCR-regulated power supplies is designed for medium to high-power applications requiring a fixed or variable dc source with moderate regulation and ripple. For supplies with better regulation, faster response time, and lower ripple, see models 6259B—6274B and 895A, on page 236.

Operating Features

All supplies in this series are of the constant voltage/constant current type. Large easy-to-read panel meters continuously monitor output voltage current.

Input and output power, remote sensing, remote programming, and auto-series, -parallel, and -tracking connections are made to bus bars and terminal blocks on the rear panel.

Protective Features

In addition to the overload protection inherent in constant voltage/constant current operation, there are many other built-in protective features included in these supplies. The features vary within the three model classifications as follows:

6434B—6448B: (1) Reverse voltage protection. (2) Fused ac input.

6453A, 6456B, 6459A: (1) AC line loss protection circuit monitors 3-phase input and cuts off SCR's and opens output bus if a phase drops out; operation resumes when ac input returns to normal. (2) 3-phase input circuit breaker. (3) Optional internal crowbar (Option 006) protects load from overvoltage condition.

6464C—6483C: (1) High-temperature protection thermostat opens input to power transformer and lights front panel indicator if supply overheats. (2) Prolonged overload protection circuit is activated and lights front panel indicator if output current exceeds approximately 115% of maximum rating. (3) Optional internal crowbar (except on 6464C) protects load from overvoltage condition. (4) Turn-on circuit limits peak line current during start-up into low impedance loads. (5) Phase-balance circuit permits operation with line-to-line input voltage imbalance up to 8%. (6) Overcurrent and overvoltage circuits of master slave supplies used in auto-series, -parallel, or -tracking operation can be interlocked.

Auto-Series, -Parallel, -Tracking Operation

Supplies may be connected in auto-series, or auto-tracking. (Except 6448B and 6483C, which cannot be connected in auto-series.)

Up to three lower power models (6434B—6448B) may be connected in any of the above configurations. Higher-power model (6453A/6483C) interconnection should ordinarily include no more than two supplies.

Remote Programming

The voltage and current outputs of the supplies can be programmed by a remote resistance, or for most models, a remote voltage source. Programming speeds and coefficients are detailed in the specifications table.

AC Power Requirements

The ac power requirements vary with the three model classifications (see option listings). When powered from a 50 Hz source (possible with option 005), the rms ripple and transient response specifications increase by 50%. The p-p ripple specification is unchanged by line frequency.

Specifications†

RATINGS			PERFORMANCE						
DC Output		Model	Load Effect		Source Effect		PARD Δ rms/p-p	Temperature Coefficient	Drift
Volts§	Amps§		Voltage	Current	Voltage	Current			
0-8	0-1000	6464C	0.05% + 5 mV	0.1% + 1 A	0.05% + 5 mV	0.1% + 1 A	80 mV/1 V	0.03% + 100 μ V	0.03% + 1 mV
0-15	0-200	6453A	0.2% + 10 mV††	1% or 2 A††	0.2% + 10 mV††	1% or 2 A††	150 mV rms	0.05% + 2 mV	0.25% + 10 mV
0-16 or 18	0-600 or 500*	6466C	0.05% + 5 mV	0.1% + 0.6 A	0.05% + 5 mV	0.1% + 0.6 A	180 mV/1 V	0.03% + 200 μ V	0.2% + 1 mV
0-36	0-100	6456B	0.2% + 10 mV††	1% or 1 A††	0.2% + 10 mV††	1% or 1 A††	180 mV rms	0.05% + 2 mV	0.25% + 10 mV
0-36	0-300	6469C	0.05% + 5 mV	0.1% + 0.3 A	0.05% + 5 mV	0.1% + 0.3 A	180 mV/1 V	0.03% + 400 μ V	0.15% + 1 mV
0-40	0-25	6434B	40 mV	200 mA	18 mV	200 mA	40 mV/500 mV	0.03% + 5 mV	0.1% + 20 mV
0-60	0-5	6438B	60 mV	50 mA	30 mV	50 mA	120 mV/400 mV	0.03% + 10 mV	0.1% + 30 mV
0-64	0-50	6459A	0.2% + 10 mV††	1% or 0.5 A††	0.2% + 10 mV††	1% or 0.5 A††	160 mV rms	0.05% + 2 mV	0.25% + 10 mV
0-64	0-150	6472C	0.05% + 100 mV	0.1% + 0.15 A	0.05% + 100 mV	0.1% + 0.15 A	160 mV/2 V	0.03% + 4 mV	0.15% + 16 mV
0-110	0-100	6475C	0.05% + 100 mV	0.1% + 0.1 A	0.05% + 100 mV	0.1% + 0.1 A	200 mV/2 V	0.03% + 5 mV	0.15% + 20 mV
0-120	0-2.5	6443B	120 mV	25 mA	60 mV	25 mA	240 mV/400 mV	0.03% + 20 mV	0.1% + 60 mV
0-220	0-50	6477C	0.05% + 100 mV	0.1% + 50 mA	0.05% + 100 mV	0.1% + 50 mA	330 mV/2 V	0.03% + 8 mV	0.15% + 35 mV
0-300	0-35	6479C	0.05% + 100 mV	0.1% + 35 mA	0.05% + 100 mV	0.1% + 35 mA	330 mV/3 V	0.03% + 11 mV	0.15% + 45 mV
0-440, 500 or 600	0-25, 20, 15*	6483C	0.05% + 100 mV	0.1% + 35 mA	0.5% + 100 mV	0.1% + 35 mA	600 mV/5 V	0.03% + 20 mV	0.15% + 80 mV
1-600	5 mA-1.5 A	6448B	1 V	40 mA	600 mV	15 mA	600 mV/2 V	0.03% + 100 mV	0.1% + 300 mV

†Refer to page 228 for complete specification definitions.

††Specified for combined line end load regulation.

Δ For operation with a 50 Hz input (possible only with Option 005), the rms ripple and transient response specifications are increased by 50%.

* The output current rating is given in the same order corresponding with the voltage rating.

§ Under light loading conditions, power supply may not meet all published specifications. The graph on the next page defines the permissible operating regions for CV and CC modes of operation.

For operation with a 50 Hz input (possible only with Option 005), output current is linearly derated from 100% at 40°C to 80% at 50°C.

POWER SUPPLY OUTPUT RESTRICTIONS AS A FUNCTION OF LOADING

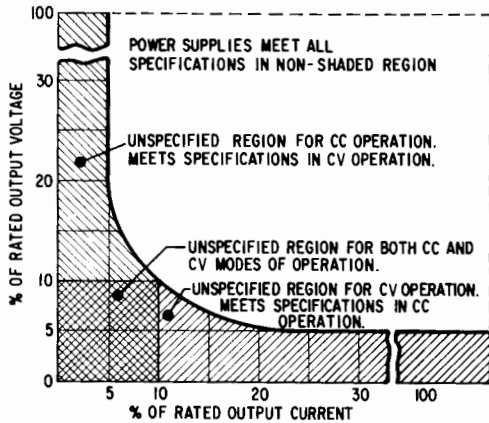

An ac input option must be specified when ordering.

Line Cords

Line cords are not supplied with models 6453A-6483C.

Size

Models 6438B and 6443B: 89 H x 483 W x 445 mm D (3.5" x 19" x 17.5").

Models 6434B, & 6448B: 133 H x 483 W x 432 mm D (5.25" x 19" x 17").

Models 6453A, 6456B, & 6459A: 356 H x 483 W x 500 mm D (14" x 19" x 19.7").

Models 6464C, 6466C, 6469C, 6472C, 6475C, 6477C, 6479C, & 6483C: 705 H x 483 W x 715 mm D (27.75" x 19" x 28.12").

Option Descriptions

6434B-6448B

Std: 115 V ac, ± 10%, single phase, 57-63 Hz

005: realignment for 50 Hz operation

010: chassis slides

027: 208 V ac, ± 10%, single phase, 57-63 Hz

028: 230 V ac, ± 10%, single phase, 57-63 Hz

910: one extra operating and service manual shipped with each power supply

Specifications, continued

6453A, 6456B, 6459A

An ac input option must be specified when ordering.

AC input connections are by means of a 4-conductor connector at rear of unit. A matching Hubbell No. 7413G plug (HP part number 1251-1570) is furnished.

001: 208 V ac, ± 10%, 3-phase, 15.5 A/phase, 57-63 Hz

002: 230 V ac, ± 10%, 3-phase, 14 A/phase, 57-63 Hz

003: 460 V ac, ± 10%, 3-phase, 7 A/phase, 57-63 Hz

005: realignment for 50 Hz operation

006: overvoltage protection crowbar

6453A, 6459A

6456B

010: chassis slides

031: 380 V ac, ± 10%, 3-phase, 8.5 A/phase, 57-63 Hz

032: 400 V ac, ± 10%, 3-phase- 8.0 A/phase, 57-63 Hz

910: one extra operating and service manual shipped with each power supply

6464C-6483C

An ac input option must be specified when ordering.

AC input connections are by means of enclosed 4-wire terminal block

001: 208 V ac, ± 10%, 3-phase, 55 A/phase, 57-63 Hz

002: 230 V ac, ± 10%, 3-phase, 50 A/phase, 57-63 Hz

003: 460 V ac, ± 10%, 3-phase, 25 A/phase, 57-63 Hz

005: realignment for 50 Hz operation

006: internal overvoltage protection crowbar

6477C, 6479C, 6483C

6466C

6469C

6472C, 6475C

023: rack mounting attachments for standard 19" rack

031: 380 V ac, ± 10%, 3-phase, 30 A/phase, 57-63 Hz

032: 400 V ac, ± 10%, 3-phase, 28.5 A/phase, 57-63 Hz

040: prepares power supply to be programmed with resistance by a 6940B or 6942A.

910: one extra operating and service manual shipped with each power supply

Accessory

14545A: casters for 6464C-6483C—set of four

REMOTE CONTROL											GENERAL		
Resolution		Load Transient Recovery Δ	Resistance Coefficient		Voltage Coefficient \dagger		Up		Down		Net Weight		Options
			Voltage	Current	Voltage	Current	NL	FL	NL	FL	Kg	lb	
8 mV	1 A	100 ms, 500 mV	200 Ω /V \pm 2%	1 Ω /A \pm 2%	1 V/V \pm 1%	6.2 mV/A \pm 7%	1.6 s	0.6 s	6 s	0.1 s	235	518	1, 2, 3, 5, 23, 31, 32, 40
65 mV	1 A	50 ms, 150 mV	200 Ω /V \pm 2%	1 Ω /A	0.4 V/V	30 mV/A	1 s	0.5 s	20 s	0.2 s	108	238	1, 2, 3, 5, 6, 10, 31, 32
18 mV	0.5 A	100 ms, 500 mV	200 Ω /V \pm 2%	1.66 Ω /A \pm 2%	1 V/V \pm 1%	10.3 mV/A \pm 7%	1.6 s	0.6 s	15 s	0.2 s	226	500	1, 2, 3, 5, 6, 23, 31, 32, 40
90 mV	0.5 A	50 ms, 300 mV	200 Ω /V \pm 2%	2 Ω /A	166 mV/V	60 mV/A	1 s	0.5 s	60 s	0.5 s	108	238	1, 2, 3, 5, 6, 10, 31, 32
36 mV	0.3 A	100 ms, 500 mV	200 Ω /V \pm 2%	3.33 Ω /A \pm 2%	1 V/V	20.6 mV/A \pm 7%	1.6 s	3 s	20 s	0.5 s	226	500	1, 2, 3, 5, 6, 23, 31, 32, 40
10 mV	12.5 mA	200 ms, 200 mV	200 Ω /V \pm 2%	12 Ω /A	1 V/V	**	0.3 s	1.2 s	75 s	1.2 s	30.4	67	5, 10, 27, 28
9 mV	2.5 mA	200 ms, 300 mV	300 Ω /V \pm 2%	60 Ω /A	1 V/V	**	0.5 s	2.5 s	200 s	2.5 s	14	31	5, 10, 27, 28
100 mV	0.25 A	50 ms, 600 mV	300 Ω /V \pm 2%	4 Ω /A	94 mV/V	120 mV/A	1 s	0.5 s	45 s	0.7 s	108	238	1, 2, 3, 5, 6, 10, 31, 32
64 mV	0.15 mA	100 ms, 750 mV	300 Ω /V \pm 2%	6.7 Ω /A \pm 2%	1 V/V \pm 3%	41.2 mV/A \pm 7%	1.4 s	2.5 s	55 s	0.7 s	226	500	1, 2, 3, 5, 6, 23, 31, 32, 40
22 mV	0.1 A	100 ms, 1 V	300 Ω /V \pm 2%	10 Ω /A \pm 2%	1 V/V \pm 3%	62 mV/A \pm 7%	1.5 s	2 s	80 s	0.7 s	226	500	1, 2, 3, 5, 6, 23, 31, 32
30 mV	1.3 mA	200 ms, 600 mV	300 Ω /A \pm 2%	120 Ω /A	1 V/V	**	0.5 s	2 s	210 s	2 s	14	31	5, 10, 27, 28
44 mV	50 mA	100 ms, 2 V	300 Ω /V \pm 2%	20 Ω /V \pm 2%	1 V/V \pm 3%	124 mV/A \pm 7%	1.5 s	2 s	95 s	1 s	226	500	1, 2, 3, 5, 6, 23, 31, 32
60 mV	35 mA	100 ms, 3 V	300 Ω /V \pm 2%	28.6 Ω /A \pm 2%	1 V/V \pm 3%	177 mV/A \pm 7%	1.5 s	2 s	75 s	1.6 s	226	500	1, 2, 3, 5, 6, 23, 31, 32
60 mV	25 mA	100 ms, 5 V	300 Ω /V \pm 2%	40 Ω /A \pm 2%	1 V/V \pm 3%	0.25 V/A \pm 7%	1.5 s	2 s	120 s	2 s	226	500	1, 2, 3, 5, 6, 23, 31, 32
60 mV	0.75 mA	200 ms, 3 V	300 Ω /V \pm 2%	600 Ω /A	1 V/V	**	0.2 s	1 s	45 s	2 s	27.6	61	5, 10, 27, 28

Δ For operation with a 50 Hz input (possible only with Option 005), the rms ripple and transient response specifications are increased by 50%.

**This feature is not available.

*An ac input option must be specified when ordering these 3-phase models.

\dagger Special Option J30 must be ordered with models 6434B-6448B and 6466C-6483C to be programmed with a 59501B Power Supply Programmer. Contact your local HP Field Engineer for ordering instructions.



POWER SUPPLIES

200 Watt System Power Supply

Model 6034A

- HP-IB programming of voltage, current and OVP
- HP-IB measurement of voltage and current
- Full operating status readback
- Autoranging output
- Service request capability
- Self-test and diagnostics

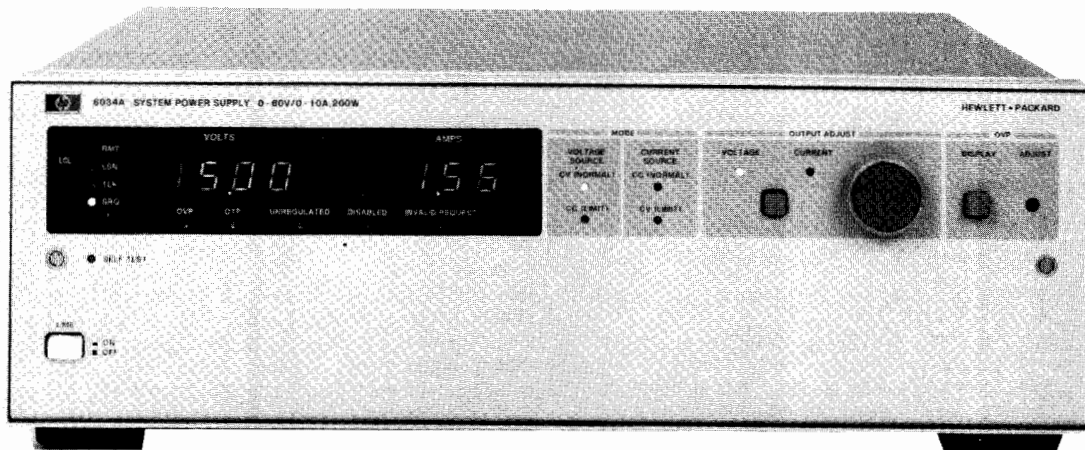

Description

The 6034A DC power supply has a combination of features and specifications that characterize it as a comprehensive solution to HP-IB system power supply applications. The 6034A combines FET switching technology with an internal microprocessor-based HP-IB programmer to achieve the first bidirectional programmable autoranging dc power supply.

FET switching technology provides laboratory-grade performance specifications and autoranging capability in a compact lightweight package. The high electrical efficiency, obtained through the use of flyback switching, reduces your overall system cooling requirements. The microprocessor-based HP-IB interface provides a friendly programming format. Output voltage and current can be programmed directly in volts and amperes with 12-bit resolution. Information regarding the output and load is available through remote metering over the HP-IB.

As an autoranging power supply, the 6034A can provide maximum rated power over a wide range of voltage and current without the operator having to program the proper range.

Eight status parameters can be read back via the HP-IB to enhance system versatility. These status parameters permit identification of the operational mode and fault conditions of the 6034A. They also can be used to initiate corrective action for fault conditions without operator intervention. The overvoltage trip point can be programmed directly in volts with 8-bit resolution, or set with a front panel adjustment. Other protection oriented features include soft voltage and current limits, and overtemperature protection. Soft limit protection allows the user to program limits such that only voltage and current values within these limits will be accepted by the power supply.

System Applications

The 6034A incorporates many system features that can significantly reduce the time needed for hardware and software development. These features include friendly programming of voltage, current, and overvoltage protection, readback of voltage or current, full service request interrupt capability and operating status readback. The following two applications illustrate the power and flexibility of the 6034A.

Automatic PC Board Test

The interactive nature of the 6034A is of particular value in a PC board test system. For example, voltage can be programmed along with a current limit to protect board tracks. Either a constant voltage or constant current can be programmed as the normal operating mode via the HP-IB. If the board under test has a rail to rail short as a result of a defective component or bridged tracks, the current limit setting will prevent damage to the PC board's power distribution system and components. Utilizing the status readback capabilities of the 6034A when constant voltage (CV) has been defined as the normal operating mode of the supply, the shorted component or bridged track can cause the 6034A to initiate a service request (SRQ). The mode crossover condition can then be relayed to the controller through a serial poll. A remote voltage reading can also be taken across the load and sent back to the controller. If the voltage is close to zero, the controller can display the "shorted load" condition to the system operator. Conversely, if a remote measurement is taken and the supply is found to be in normal mode with a current value of zero the controller can reveal the "open load" condition to the operator. Software can also set up an operating power region for a particular board, and the 6034A coupled with that software can determine whether the board under test is drawing power within the anticipated boundaries.

Incoming Inspection of Electronic Components

The forward characteristics of a rectifier diode can be evaluated by the 6034A for incoming inspection.

The controller compares characteristics tested by the 6034A with established standards and rejects out-of-spec units. The system can then plot individual device E-I characteristics, or reduce the data on an entire lot of devices to graphical or statistical form.

Without the 6034A, a current shunt and an HP-IB voltmeter would be required to implement this test system. However, with the 6034A, both stimulus and response are effected through a single system component, thereby reducing your system hardware costs and rack space requirements. Also, the microprocessor-based architecture of the 6034A offers an easy programming format.

Specifications

All performance specifications are measured at the rear terminals with a resistive load and at 25°C ± 5°C.

DC output: voltage and current output can be programmed with the HP-IB or the front panel control over the following ranges:

voltage: 0-60 V **current:** 0-10 A

Maximum available output power from 20 V to 60 V is indicated below.

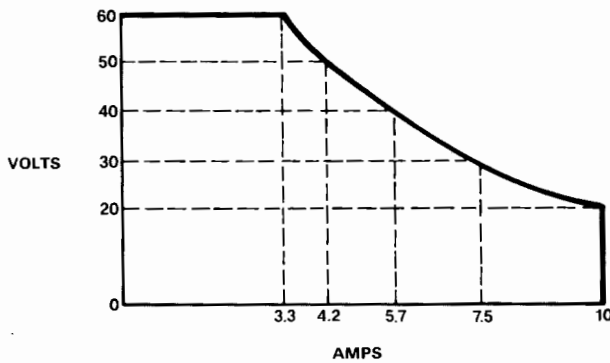

Load effect: (load regulation)

Voltage: ±0.01% ± 3 mV **Current:** 0.01% + 3 mA

Source Effect

Voltage: 0.01% + 2 mV **Current:** 0.01% + 2 mA

PARD: (Ripple and Noise) RMS/p-p, 20 Hz to 20 MHz:

Voltage: 3 mV/30 mV **Current:** 5 mA RMS

Temperature coefficient: Δ/°C after 30 minute warmup:

Voltage: ±0.009% ± 0.7 mV **Current:** ±0.009% ± 0.8 mA

Load transient recovery time: less than 1 ms is required for output voltage recovery (in constant voltage operation) to within 75 mV of the nominal output following a change in output current from 90% to 100% or 100% to 90% of maximum current.

Programming Resolution

Voltage: 15 mV (12 bits) **Current:** 2.5 mA (12 bits)

Programming Accuracy (25 ± 5°C)

Constant voltage: ±0.07% ± 28 mV

Constant current: ±0.085 ± 12.5 mA

Output impedance: typical value is 1 mΩ in series with 30 μH, but less than 1 Ω for all frequencies less than 1 MHz.

Drift: (stability) change in output over an 8 hour interval with fixed conditions after 30 minute warmup.

Voltage: ±0.03% ± 3 mV **Current:** ±0.03% ± 3 mA

Programmable Time Delay

Range: 0-65,535 ms

Resolution: 1 ms

Accuracy: ± 5% nominal

Amplified current monitor: scale Factor 0-5 V monitor output for 0-10 A output current:

Accuracy: 0.1% + 7 mV typical

Output impedance: 10 kΩ nominal

RFI specifications: meets VDE 0871/6.78 Level A

Programming response time: maximum time for output voltage to change from 0 V to 60 V or 60 V to 2 V and settle within a 60 mV band (0.1% of maximum rated output):

	Band	60 mV(*)	15 mV(**)
Up:	Full Load (18 Ω)	200 ms	225 ms
	No Load	200 ms	225 ms
Down:	Full Load (18 Ω)	300 ms	450 ms
	No Load	600 ms	750 ms

*Max, ** (Typical)

Front Panel Meters

Output voltage: Low Range: ± 20.00 V

High Range: ± 200.0 V

Range switch points: Up: above 19.99 V ± 0 V

Down: below 17.5 V nominal

Resolution: Low Range: 10 mV

High Range: 100 mV

Accuracy: Low Range: ± 20 mV ± 0.07%

High Range: ± 200 mV ± 0.09%

Temperature coefficient: ± .01%/°C

Output Current

Range: ± 19.99 A

Resolution: 10 mA

Accuracy: ± 17 mA ± 0.1%

Temperature coefficient: ± 0.01%/°C ± 0.7 mA/°C

OVP setting: (with reference to A2, not to -S)

Range: 200.0 V

Resolution: 100 mV

Accuracy: 0.5% + 150 mV (at 0.0 A load current)

Remote Meters

Output Voltage

Range: 0-60 V

Resolution: 15 mV

Accuracy: ± 0.08% ± 35 mV

Temperature coefficient: ± 0.007%/°C ± 0.35 mV/°C

Output Current

Range: 0-10 A

Resolution: 2.5 mA

Accuracy: ± 0.125% ± 8.5 mA

Temperature coefficient: ± 0.006%/°C ± 0.6 mA/°C

Settling time: < 200 ms

Overvoltage Protection

Local OVP adjustment: the lower of the two OVP trip points will dominate.

Range: 1.7 V to 64.5 V

Resolution: 0.2 V

Remote OVP Adjustment

Range: 2.0 V to 64.5 V (the OVP trip point = 2 V + 1.04 × soft voltage limit)

Resolution: 0.25 V

Accuracy: ± 0.7 V. The OVP circuit will trip when the voltage between the + output and the outboard side of the current monitoring resistor equals the set voltage. This could be as much as 1.35 V above the voltage between the ± S terminals.

Temperature coefficient: 250 PPM/°C

DC output isolation: ± 240 Vdc from ground.

Temperature rating: operating 0-55°C

Storage: -40 to 75°C, Fan cooled

AC input: 87 to 106 Vac Option 100

104 to 127 Vac Option 120

191 to 233 Vac Option 220

208 to 250 Vac Option 240

All are 48 to 63 Hz

(Two internal switches and one internal jumper permit line voltage selection except for Option 100)

325 watts @ 200 watts output

600 VA @ 200 watts output

Weight: Net 9.9 kg (20 lbs). Shipping: 10.4 kg (23 lbs)

Ordering Information

6034A System Power Supply

Opt 100 (100 Vac input. Max 50 V, 150 W output)

Opt 120, 220 and 240

Opt 907: front handle kit (part No. 5061-0089)

Opt 908: rack flange kit (part No. 5061-0077)

Opt 909: Opt. 907, 908 combined (part No. 5061-0083)

Opt 910: additional operating and service manual



POWER SUPPLIES

200 Watt System Power Supply

Model 6002A

- 200 watt autoranging dc output
- Constant-voltage / constant-current operation
- HP-IB programming option

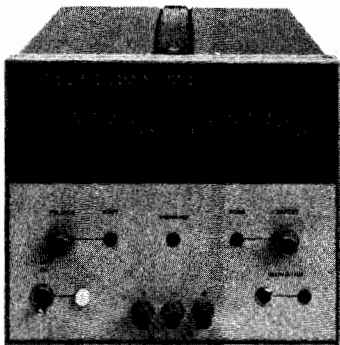

6002A

Description

The 6002A dc power supply offers an exceptional combination of performance and flexibility. It employs a unique control concept which provides for an autoranging output with the performance characteristics of linear regulation. The 6002A is a 200 watt CV/CC power supply, which may be remotely programmed via the HP-IB, when equipped with Option 001.

As an autoranging power supply, the 6002A can provide 200 watts over a wide range of voltage and currents without external intervention. This allows it to take the place of multiple conventional power supplies. For example, the 6002A can replace both a 50 volt, 4 amp supply and a 20 volt, 10 amp supply.

Autoranging Output Characteristic

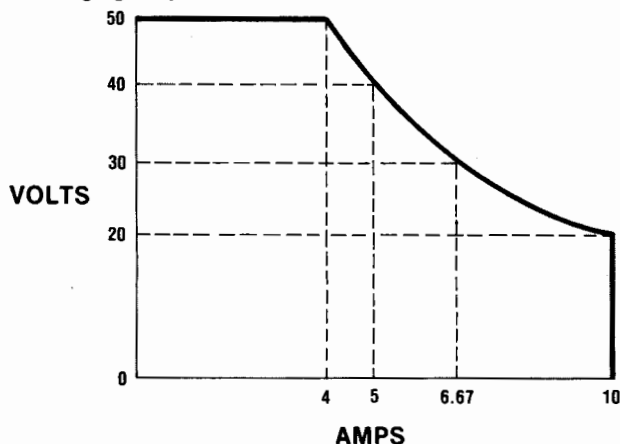

System Features/Remote Control

Analog programming of output voltages and current can be accomplished through the use of remotely controlled resistance or voltage applied to rear panel terminals. Additional control terminals are provided for remote load voltage sensing, auto-series or parallel operation, and for remotely activating the crowbar circuit. A pulse output from the crowbar terminal indicates the overvoltage circuit has been self-activated. A voltage step change appearing on terminal indicates a changeover to or from constant-current operation.

HP-IB Option

Digital programming via Option 001 permits control of output voltage or current by the Hewlett-Packard Interface Bus (HP-IB). Two programmable ranges allow better resolution below 10 volts or 2 amps. The selection of HP-IB control of either voltage or current is done by rear panel switches. The IEEE 488 interface functions supported by the 6002A with Option 001 are basic listener (L2) and acceptor handshake (AH1). Complete explanation of these interface functions is available in the IEEE Std. 488-1978.

- Built-in overvoltage protection crowbar
- CV / CC operating status indicators
- Remote analog programming and sensing

Choosing a System Power Supply

Hewlett-Packard offers many solutions for 200 watt system power supply applications. Depending upon the specific application needs, either the 6034A (page 240) or the 6002A will offer the best solution. The 6034A offers complete and friendly remote programming including voltage, current, and OVP trip level. The output voltage or current can be read back over the HP-IB, and interrupts can be generated on preset conditions. The 6002A offers particularly good performance in the areas of ripple and noise and load transient recovery. The programmability and power supply specification needs should be weighed when choosing the system power supply most suited to a particular application.

Specifications

DC output: voltage and current output can be adjusted over the ranges indicated by front panel controls, analog programming, or an optional HP-IB interface.

Voltage: 0–50 V. **Current:** 0–10 A.

Maximum 200 Watts output from 20 V to 50 V.

Load effect: constant-voltage, 0.01% +1 mV. Constant-current, 0.01% + 1 mA.

Source effect: CV, 0.01% +1 mV; CC, 0.01% + 1 mA.

PARD (ripple and noise): rms/p-p, 20 Hz to 20 MHz; CV, 1 mV/10 mV; CC, 5 mA rms.

Temperature coefficient: CV, 0.02% +200 μ V/°C; CC 0.02% +5 mA/°C.

Drift: CV, 0.05% +1 mV/8 hrs; CC, 0.05% +5 mA/8 hrs.

Load transient recovery: 100 μ s for output voltage to recover within 15 mV of nominal voltage setting following a load current change of 50% to 100% or 100% to 50% of full load current.

Response time: maximum time for output voltage to change between 0 to 99.9% or 100% to 0.1% of maximum rated output voltage. Up Programming: no load, 100 ms; full load, 100 ms. Down Programming: no load, 400 ms; full load, 200 ms.

Overvoltage protection: trip voltage adjustable from 2.5 V to 60 V. **DC output isolation:** 150 V dc.

Power: 100, 120, 220, or 240 V ac (–13%, +6%), 48-63 Hz.

Temperature rating: 0°C to 55°C operating, –40°C to +75°C storage. Supply is cooled by built-in fan.

Size: 180 H x 212 W x 422 mm D (6.97" x 8.36" x 16.6").

Weight: net, 14.5 kg (32 lb). Shipping, 15.9 kg (35 lb).

HP-IB Option

Programmable ranges: high: 0–50 V or 0–10 A, low: 0–10 V or 0–2 A.

Programming speed: same as response time.

Accuracy: hi range: CV, 0.2% +25 mV; CC, 0.2% +25 mA. lo range: CV, 0.2% + 10 mV; CC, 0.2% +25 mA.

Resolution: hi range: CV, 50 mV; CC, 10 mA. (12 bit) lo range: CV, 10 mV; CC, 2 mA. (12 bit)

Isolation: 250 volts dc from bus data lines to power supply.

Accessories

5061-0060: rack mounting adapter kit for one 6002A

5061-0094: cabinet lock-together kit to connect two 6002A's

5061-0078: rack flange kit to mount 2 locked 6002A's

Options

001: HP-IB interface

910: one extra operating and service manual

6002A Autoranging DC Power Supply

Digital Programmable: HP-IB Programmer

Model 59501B

- HP-IB power supply control
- HP-IB-to-power-supply isolation
- Programmable range

- Programmable 10-volt dc output
- Unipolar/bipolar operation
- Fast digital to analog conversion

Specifications

Digital to Analog Converter

DC output voltage: programmable in high or low ranges within the voltage limits shown below. Output mode is unipolar or bipolar and is selected by a rear panel switch.

Unipolar: 0 to 9.99 V (low range, 0 to 9.999 V).

Bipolar: -10 to +9.98 V, (low range, -1 to +0.998 V).

DC output current: 10 mA maximum.

PARD (ripple and noise): 2 mV rms/10 mV p-p.

Resolution: unipolar, 10 mV (low range, 1 mV). Bipolar, 20 mV (low range, 2 mV).

Accuracy: specified at 23°C ± 5°C.

Unipolar: 0.1% + 5 mV (low range, 0.1% + 1 mV).

Bipolar: 0.1% + 10 mV (low range, 0.1% + 2 mV).

Stability: change in output over 8 hour interval under constant line, load, and ambient following a 30 minute warm-up. Stability is included in accuracy specification measurements over the temperature range indicated.

Unipolar: 0.04% + 0.5 mV (low range, 0.04% + .1 mV).

Bipolar: 0.04% + 1 mV (low range, 0.04% + .2 mV).

Temperature coefficient: unipolar, 0.01%/°C + 0.5 mV/°C (low range, 0.1%/°C + 0.1 mV/°C). Bipolar, 0.01%/°C + 0.5 mV/°C (low range, 0.01%/°C + 0.1 mV/°C).

Zero adjust: plus or minus 250 millivolts.

D/A full scale adjust: plus or minus 5%.

Programming speed: the time required for output to go from zero to 99% of programmed output change is 250 μs (measured with resistive load connected to output terminals).

Power Supply Programming

Programming network specifications: in the following specifications, M represents the calibrated full scale value of the supply being programmed and P is the actual programmed output. The full scale value (M) can be any value within the supply's output range and is calibrated with the 59501B programmed to its maximum high range output.

Accuracy: specified at 23°C ± 5°C.

Unipolar: 0.05% M + 0.25% P (low range, 0.01% M + 0.25% P).

Bipolar: 0.1% M + 0.25% P (low range, 0.02% M + 0.25% P).

Isolation: 600 V dc between HP-IB data lines and output terminals.

Temperature coefficient: 0.005% M/°C + 0.015% P/°C (low range, 0.01% M/°C + 0.015% P/°C).

Programming resolution: 0.1% M (low range, 0.01% M).

Programming speed: D/A programming speed plus the programming speed of the power supply.

General

Temperature range: operation: 0 to 55°C, Storage: -40 to 75°C.

Power: 100, 120, 220, or 240 Vac (+6% -13%) 47-63 Hz, 10 VA (selectable on rear panel).

Size: 101.6 H x 212.9 W x 294.6 mm D (4" x 8.38" x 11.6").

Weight: net 1.82 kg (4 lb). Shipping 2.27 kg (5 lb).



Description

The 59501B is an isolated digital-to-analog converter designed to provide a convenient interface between the Hewlett-Packard Interface Bus and HP power supplies. With the 59501B, a wide range of dc voltages and currents becomes automatically controllable via the HP-IB. With proper wiring, the built-in isolation devices protect other instrumentation on the HP-IB from damage that could be caused by power supply outputs. In addition, an internal control circuit holds the output level near zero until programmed data is received. A programmable High/Low range control improves resolution by ten-to-one.

Power supply control is accomplished through the 59501B's programmable output voltage and programming network (see below). By making the appropriate connections between the 59501B's rear terminals and the remote programming terminals on the supply, the output voltage (or current) of the supply can be programmed from zero to its full rated output. The 59501B front panel controls provide fast and easy calibration of power supply outputs. The Zero Adjust enables the user to correct for small offsets in power supply response to programmed inputs. The Power Supply Full Scale Adjust (part of programming network) enables the user to set the maximum output desired from the power supply when the 59501B is programmed to its maximum value. For example, this adjustment would normally be used to calibrate the maximum programmable output of a 320Vdc power supply to 320 volts. However, it could also be used to set the maximum to 200 volts.

The 59501B also can be used directly as a low level dc signal source. Unipolar and bipolar output modes are available with output voltages programmable from zero to 9.99 volts, or minus 10.0 to plus 9.98 volts. Output current up to 10 milliamps is available and is automatically limited to protect the 59501B and user equipment. The 59501B produces a full scale voltage change in approximately 250 μs from the time the digital data is received.

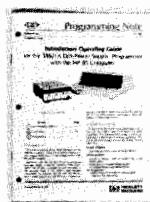
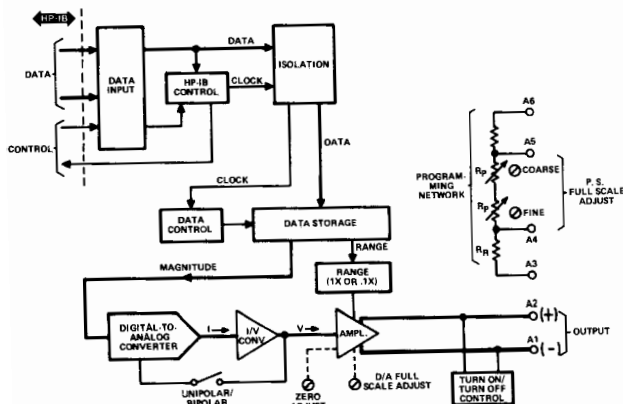

Several programming notes are available to assist in operating the 59501B Power Supply Programmer with the HP desktop computers

Accessories

5061-0072: rack mounting adapter kit for one 59501B

5061-0094: cabinet lock-together kit to connect two 59501B's

5061-0074: rack flange kit to mount two locked 59501B's

Ordering Information

59501B HP-IB Isolated D/A Power Supply Programmer

POWER SUPPLIES

Precision Bipolar System Supplies

Models 6129C-6131C & 6140A

- HP-IB compatible options P05 and J99 with the 59301A
- Fast, accurate, high resolution programming
- Bipolar output

- Current sink or source
- Programmable current latch (on voltage sources) or voltage limit (on current sources)
- Isolated output

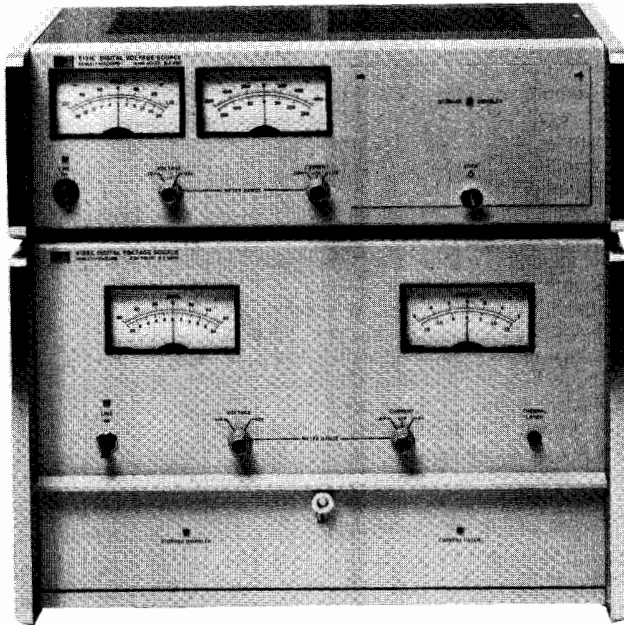

Description

The family of Precision Bipolar System Supplies consists of three voltage sources (6129C, 6130C and 6131C) and one current source (6140A). They provide easy, fast and accurate programming of their dc outputs, with many features oriented specifically towards efficient integration in automatic systems.

HP-IB

These system power supplies, when ordered with either option P05 or J99, may be programmed on the HP-IB via the 59301A ASCII to parallel converter.

Isolation

All digital inputs are completely isolated from the analog outputs.

Programmable Current Limit (voltage source)

Valuable loads can be protected by a user programmable current latch. Output power goes to zero when the latch circuit is tripped. The reaction time to the latch can be adjusted, if desired, to avoid tripping when reprogramming with a capacitive load. There is also a fixed current limit at 110% of rated current output.

Current Monitoring Terminals (voltage sources)

A voltage is available at the rear barrier strip which is proportional to the output current.

Analog Input

An ac signal may be injected into the output amplifier to simulate various noise and ripple conditions.

Precision Bipolar System Current Source

The 6140A Current Source has features which correspond to the voltage sources. It has a programmable voltage limit, voltage monitoring terminal, as well as isolation, HP-IB options, and analog input capabilities.

Accessories Furnished

- 1251-0086 50-contact rear plug.
- 5060-7948 Plug-in extender board for voltage source.
- 5060-7948/5060-7982 Two plug-in extender boards for current source.

Specifications

	Binary Instruments Option J20 & P05		BCD Instruments Option J99	
	X1 Range	X10 Range	X1 Range	X10 Range
6129C				
Output	± 16.384 V, 5 A	± 50.00 V, 5 A	± 9.999 V, 5 A	± 50.00 V, 5 A
Accuracy	1.5 mV	15 mV	1.5 mV	15 mV
Resolution	0.5 mV	5 mV	1 mV	10 mV
6130C				
Output	± 16.384 V, 1 A	± 50.00 V, 1 A	± 9.999 V, 1 A	± 50.00 V, 1 A
Accuracy	1 mV	10 mV	1 mV	10 mV
Resolution	0.5 mV	5 mV	1 mV	10 mV
6131C				
Output	± 16.384 V, 0.5 A	± 100.00 V, 0.5 A	± 9.999 V, 0.5 A	± 99.99 V, 0.5 A
Accuracy	1 mV	10 mV	1 mV	10 mV
Resolution	0.5 mV	5 mV	1 mV	10 mV
6140A				
Output	± 16.384 mA, 100 V	± 163.84 mA, 100 V	± 9.999 mA, 100 V	± 99.99 mA, 100 V
Accuracy	1 µA ± 0.01%	10 µA ± 0.01%	10 µA ± 0.01%	10 µA ± 0.01%
Resolution	0.5 µA	5 µA	1 µA	10 µA

Options

AC Power Option

028: transformer tap change for 230 V ac ± 10%, single-phase input on 6130C and 6131C.
(6129C and 6140A are 115/230 switch selectable)

Standard Interface Options*

P05: 16 bit binary programming format with modifications to interface to the 59301A, and be programmed on the HP-IB. In addition to power supply modifications, a cable to connect the supply to the 59301A, and programming documentation are included.

J99: 4 digit BCD programming format, otherwise similar to Opt. P05. A cable, and programming documentation, are included.

J20: 16 bit binary interface for 12661A I/O programmer card for Hewlett-Packard computers.

Accessories Available

14533B: Pocket programmer permits manual programming of all input functions by switch closure

14534A Pocket programmer extension cable (3 ft)

14535A HP computer interface kit includes 12661A

computer I/O card, 14539A cable, verification software and RTE Driver. Up to eight PBSS's may be controlled from one 14535A

14536A: Chaining cable connects an additional PBSS to the existing chain of PBSS's

Ordering Information*

6129C: Digital Voltage Source

Opt 908: Rack Flange Kit

6130C, 6131C: Digital Voltage Source

6140A: Digital Current Source

Opt 908: Rack Flange Kit

Opt 910: One extra operating and service manual shipped with each power supply

*An interface option must be ordered.

POWER SUPPLIES

Special Purpose: DC Power Supply/ Amplifiers
Models 6824A-6827A

- High speed remote programming
- Overload protection
- Wide-band response

- Bipolar voltage
- Current sink or source

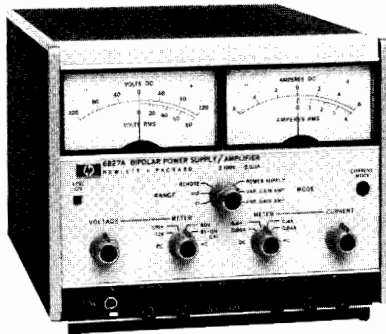

6825A-6827A

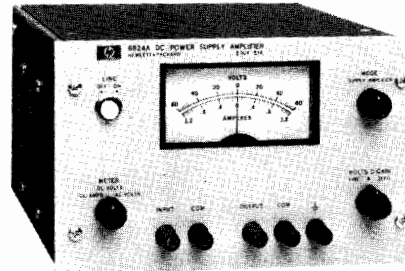

6824A

Description

The Power Supply/Amplifier is a general-purpose instrument useful in any laboratory engaged in research and development of electronic systems, circuitry, or components. The unit can be operated in one of two basic operating modes: power supply or amplifier. Terminals at the rear permit access to various internal control points to further expand the operational capabilities of the instrument. The resulting flexibility lends the Power Supply/Amplifier to an almost unlimited number of applications.

Models 6825A Through 6827A

These models feature dual-range output and constant-voltage/constant-current operation. Output voltage and current as a dc supply, or gain as a power amplifier, are remotely controllable and are compatible with Hewlett-Packard Multiprogrammer Systems.

As a dc power supply, the unit can furnish a bipolar, constant-voltage or constant-current output. It can be remotely programmed with a resistance, voltage, or current and its high speed programming characteristics adapt it to a wide variety of laboratory and production testing applications. The supply can sink, as well as source, current permitting it to serve as a variable load device.

As a direct-coupled power amplifier, each unit offers a signal-to-noise ratio of approximately 80 dB at full output with low distortion and a frequency response up to 40 kHz in the fixed gain mode.

Model 6824A

Although this model does not provide quite the level of performance and flexibility of Models 6825A through 6827A, it is lower in cost and is suitable for many applications.

As a power supply, this unit offers constant-voltage/current-limiting operation, remote programming, and Auto-Series, Auto-Parallel operation.

As a power amplifier, the unit exhibits a high signal-to-noise ratio with a 20 dB gain from dc to 10 kHz. It is useful in servo systems, as a pulse or oscillator amplifier, for motor control, and a variety of other applications.

General Specifications

Temperature: operating, 0 to 55°C, storage, -40 to +75°C.

Power: 6824A, standard input voltage is 104-127 V ac, 48-63 Hz. Order Option 028 for 230 V \pm 10% operation. 6825A & 6826A, 6827A, switchable, 100, 120, 220, or 240 V ac, -13% +6%, 48-63 Hz, 150 W.

Size: 6824A, 131 H x 209 W x 303 mm D (5 $\frac{1}{32}$ " x 8 $\frac{7}{32}$ " x 11 $\frac{15}{16}$ "). 6825A, 6826A & 6827A, 155 H x 198 W x 316 mm D (6 $\frac{3}{32}$ " x 7 $\frac{25}{32}$ " x 12 $\frac{7}{16}$ ").

Weight: 6824A, 7.7 kg (17 lb), 6825A, 6826A & 6827A, 8.2 kg (18 lb).

Specifications

RATINGS		POWER SUPPLY PERFORMANCE						POWER AMPLIFIER PERFORMANCE							
DC Output		Model	PAR (rms/p-p)		Transient Recovery		Resolution		Voltage Gain		Frequency Response, +1, -3 dB		Distortion at full output		Options
Volts	Amps		Voltage	Current	Time	Level	Voltage	Current	Fixed	Variable	Fixed Gain	Variable Gain	100 Hz	10 kHz	
-5 V to +5 V/ -20 V to +20 V	0-2.0 A Both Ranges	6825A	10/30 mV	5/15 mA	100 μ s	20 mV	40 mV	6 mA	1X 4X	0-2X 0-8X	dc-40 kHz	dc-15 kHz	0.1% THD	0.5%	9
-5 V to +5 V/ -50 V to +50 V	0-1.0 A Both Ranges	6826A	6/35 mV	0.8/5 mA	100 μ s	50 mV	100 mV	3 mA	1X 10X	0-2X 0-20X	dc-40 kHz	dc-15 kHz	0.1% THD	0.5%	9
-10 V to +10 V/ -100 V to +100 V	0-0.5 A Both Ranges	6827A	10/50 mV	0.4/5 mA	100 μ s	100 mV	200 mV	1.5 mA	2X 20X	0-4X 0-40X	dc-30 kHz	dc-15 kHz	0.1% THD	1%	9
-50 V to +50 V	0-1.0 A	6824A	10 mVrms	—	100 μ s	0.02% +5 mV	—	—	—	0-10X	—	dc-10 kHz	0.1% THD	—	9,28

Options Descriptions

028: 230 V ac \pm 10%, single phase input

910: one additional manual shipped with each power supply

6824A, 6825A
6826A, 6827A

Accessories

5060-8762: adapter frame for rack mounting one or two 6825A-6827A units

5060-8760: blank filler panel to be used with above units

14515A: rack mounting kit for one 6824A

14525A: rack mounting kit for two 6824A's



POWER SUPPLIES

Special Purpose: Precision Voltage Sources

Models 6111A-6116A

- 6114A, 6115A...CV/CC operation
- .025% output voltage accuracy
- Overvoltage crowbar



6114A, 6115A

Description

6114A, 6115A High Performance Precision Source

These 40 watt precision power supplies are ideal for applications where an accurate, highly stable, and easy-to-use source of dc voltage is required. Both models feature automatic dual range operation. For example, model 6114A can supply 0-20 V at 0-2 A, and 20-40 V at 0-1 A, without manual range switching. Automatic output current range crossover occurs when the supply is providing greater than one-half of the maximum rated output voltage. Pushbutton voltage controls on models 6114A and 6115A allow the output voltage to be set rapidly and accurately. A front-panel control allows the output current to be set to any desired value within the maximum rating. Using this control, the supplies can be operated as constant current sources with 0.01% current regulation. The internal overvoltage crowbar has a convenient front panel control.

Power: 104-127 or 208-250 V ac selected by switch, 48-440 Hz, 150 VA maximum.

Size: 166 H x 197 W x 336 mm D (6.5" x 7.75" x 13.25").

Weight: net, 7.7 kg (17 lb). Shipping, 9.5 kg (21 lb).

6111A, 6112A, 6113A and 6116A

Although these 20 watt precision power supplies do not provide quite the level of performance and flexibility of models 6114A and 6115A, they are lower in cost and are suitable for many precision power applications. Output voltage is adjusted by a five-decade thumbwheel voltage programmer for convenient and precise adjustment of output voltage. A single-turn current control allows full-range adjustment of the current-limit point.

Power: 115 V ac \pm 10%, 43-63 Hz, 0.5 A, 52 W (for 230 V, order Opt. 028).

Size: 133 H x 216 W x 318 mm D (5.25" x 8.5" x 12.5").

Weight: net, 5 kg (11 lb). Shipping, 6.8 kg (14 lb).

- 6111A-6113A, 6116A...CV/CL operation
- 0.1% output voltage accuracy
- Thumbwheel voltage control

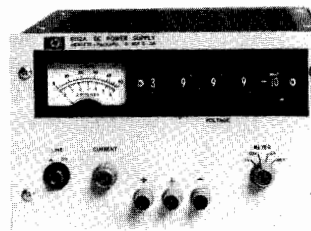

6111A, 6112A,
6113A, 6116A

Ordering Information

Option Descriptions

011: internal overvoltage, protection crowbar. Protects delicate holds against power supply failure or operator error.

028: 230 V ac \pm 10%, single-phase input. Consists of reconnecting power transformer taps, and other components where necessary.

040: Multiprogrammer interface. Prepares standard HP power supplies for resistance programming by the 6940B or 6942A Multiprogrammer.

910: one additional operating and service manual shipped with each voltage source.

Accessories

14515A: 5.25 in. high rack kit for one supply

14525A: 5.25 in. high rack kit for two supplies

The 14515A and 14525A rack kits apply to the following models: 6111A-6113A, 6116A

5060-8762: adapter frame for rack mounting one or two ½ rack width units. This frame applies to the following models: 6114A, 6115A

5060-8760: blank filler panel. This ½ rack width panel applies to the following models: 6114A, 6115A

Specifications†

RATINGS—DC Output			PERFORMANCE							General	
Volts	Amps	Model	Accuracy	Resolution	PARD (rms/p-p)	Source Effect	Load Effect	Temperature Coefficient	Drift (Stability)	Overvoltage Protection	Options
0-10	0-2	6113A	0.1% + 1 mV	20 μ V	40 μ V/100 μ V	0.001%	0.001% + 100 μ V	0.001% + 10 μ V	0.01% + 100 μ V	Opt 11, 3-13 V	11, 28, 40
0-20	0-1	6111A	0.1% + 1 mV	200 μ V	40 μ V/100 μ V	0.001%	0.001% + 100 μ V	0.001% + 10 μ V	0.01% + 100 μ V	Opt 11, 2.5-23 V	11, 28, 40
0-20, 20-40	0-2, 0-1	6114A	0.025% + 1 mV	200 μ V	40 μ V/200 μ V*	0.0005% + 40 μ V	0.0005% + 100 μ V	0.001% + 15 μ V	0.0015% + 15 μ V	STD, 0.5-45 V	
0-40	0-0.5	6112A	0.1% + 1 mV	200 μ V	40 μ V/100 μ V	0.001%	0.001% + 100 μ V	0.001% + 10 μ V	0.01% + 100 μ V	Opt 11, 2.5-44 V	11, 28, 40
0-50, 50-100	0-0.8, 0-0.4	6115A	0.025% + 1 mV	200 μ V	40 μ V/200 μ V*	0.0005% + 100 μ A	0.0005% + 50 μ V	0.001% + 15 μ V	0.0015% + 15 μ V	STD, 0.5-110 V	
0-100	0-0.2	6116A	0.1% + 1 mV	200 μ V	40 μ V/100 μ V	0.001%	0.001% + 100 μ V	0.001% + 10 μ V	0.01% + 100 μ V	Opt 11, 20-106 V	11, 28

†Refer to page 228 for complete specification definitions.

* Specified with final decade pot set to zero. If pot is set to value other than zero, pot wiper jump effect may cause drift of 0.0015% + 200 μ V (90-day).

* 200 μ V p-p noise is typical with a maximum 400 μ V p-p spike of less than 1 μ s duration occurring repetition rate of twice power line frequency under worst case conditions of high line, full output voltage. When operated at 400 Hz input, peak-to-peak ripple is less than 10 mV.

Special Purpose: Precision Constant Current Sources Models 6177C, 6181C & 6186C

- Continuously variable voltage limit
- Output useful to micro-ampere region

- High output impedance—no output capacitor

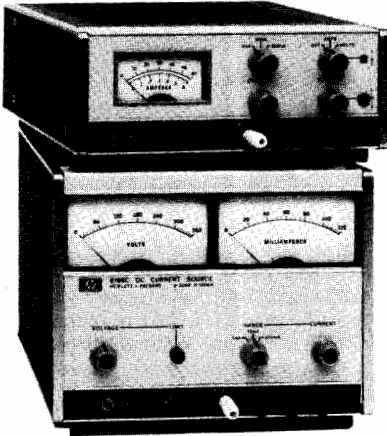

6177C, 6181C

6186C

voltage to vary from zero to maximum.

Source effect (line regulation): less than 25 ppm of output + 5 ppm of range switch setting for any change in the line voltage between 104 and 127 V ac at any output current and voltage within rating.

Load effect transient recovery: less than 800 μ s for recovery to within 1% of nominal output current following a full load change in output voltage. (On 6186C, recovery time for 100 mA/10 mA/1 mA ranges is 1 ms/1.6 ms/4 ms, respectively.)

Temperature coefficient: output change per degree C is less than 75 ppm of output current +5 ppm of range switch setting.

Drift (stability): less than 100 ppm of output current +25 ppm of range switch setting. Stability is measured for eight hours after one hour warm-up under conditions of constant line, load, temperature, and output setting.

Resolution: 0.03% of range switch setting.

Temperature rating: operating 0, to 55°C, storage, -40 to +75°C.

Accessories

5060-8764: rack adapter for rack mounting one or two 6177C or 6181C supplies

5060-8762: rack adapter for rack mounting one or two 6186C supplies

5060-8530: filler panel for Models 6177C, 6181C

5060-8760: filler panel for Model 6186C

Options

028: 230 V ac \pm 10%, single-phase input. Models 6177C and 6181C only

910: one additional operating and service manual

Ordering Information

6177C, 6181C Constant Current Source

6186C Constant Current Source

Description

These solid-state constant-current sources are ideal for semiconductor circuit development, component testing, and precision electroplating applications.

Their high-speed remote programming characteristics make these supplies useful in testing and sorting semiconductors, resistors, relays, meters, etc. The ability to superimpose ac modulation on the dc output permits the supplies to be used for measurement of dynamic or incremental impedance of circuit components.

Specifications

Load effect (load regulation): less than 25 ppm of output + 5 ppm of range switch setting for a load change which causes the output

Model		6177C	6181C	6186C	
Output Current ††		0-500 mA	0-250 mA	0-100 mA	
Voltage Compliance Δ		0-50 V dc	0-100 V dc	0-300 V dc	
Output Ranges	A	0-5 mA	0-2.5 mA	0-1 mA	
	B	0-50 mA	0-25 mA	0-10 mA	
	C	0-500 mA	0-250 mA	0-100 mA	
AC Input		115V ac \pm 10%, 48-63 Hz; 0.6 A, 55 W at 115 V ac For 230 V ac see Option 028	115 V ac \pm 10%, 48-63 Hz; 0.6 A, 55 W at 115 V ac For 230 V ac see Option 028	115/230 V ac, 48-63 Hz; 0.9 A, 90 W at 115 V ac 115/230 V ac switch	
Constant Current	Voltage Control (accuracy: 0.5% of output current +0.04% of range)	Range A	200 mV/mA	1 V/mA	10 V/mA
		Range B	20 mV/mA	100 mV/mA	1 V/mA
		Range C	2 mV/mA	10 mV/mA	100 mV/mA
Remote Programming	Resistance Control 1% of output control +0.04% of range)	Range A	400 ohms/mA	2 k Ω /mA	10 k Ω /mA
		Range B	40 ohms/mA	200 ohms/mA	1 k Ω /mA
		Range C	4 ohms/mA	20 ohms/mA	100 Ω /mA
Voltage Limit Remote Programming	Voltage Control (Accuracy: 20%)		1 V/V	1 V/V	1 V/V
		Resistance Control	870 ohms/V	435 ohms/V	820 ohms/V
		Accuracy	25%	25%	15%
Typical Output Impedance (R in parallel with C)*	Range A	R = 330 Meg, C = 500 pF	R = 1330 Meg, C = 10 pF	R = 10,000 Meg, C = 900 pF	
	Range B	R = 33 Meg, C = 0.005 μ F	R = 133 Meg, C = 100 pF	R = 1,000 Meg, C = 700 pF	
	Range C	R = 3.3 Meg, C = 0.05 μ F	R = 13.3 Meg, C = 1000 pF	R = 100 Meg, C = 1500 pF	
PARD (Ripple and Noise): rms/p-p (20 Hz to 20 MHz) with either output terminal grounded	Range A	1.6 μ A rms/40 μ A p-p	0.8 μ A rms/20 μ A p-p	0.2 μ A rms/5 μ A p-p	
	Range B	16 μ A rms/200 μ A p-p	8 μ A rms/100 μ A p-p	2 μ A rms/50 μ A p-p	
	Range C	160 μ A rms/1 mA p-p	80 μ A rms/500 μ A p-p	20 μ A rms/500 μ A p-p	
Programming Speed: from 0 to 99% of range switch setting with a resistive load ** (Output Current Modulation)		6 ms	6 ms	10 ms	
Dimensions:		7.75" (W) x 3.44" (H) x 12.38" (D) 197 mm (W) x 88 mm (H) x 315 mm (D)	7.75" (W) x 3.44" (H) x 12.38" (D) 197 mm (W) x 88 mm (H) x 315 mm (D)	7.75" (W) x 3.44" (H) x 12.38" (D) 197 mm (W) x 158 mm (H) x 315 mm (D)	
Weight: (Net/Shipping)		4.53 kg (10 lb)/5.9 kg (13 lb)	4.53 kg (10 lb)/5.9 kg (13 lb)	5.9 kg (13 lb)/7.7 kg (17 lb)	

* This network is a simplified representation of a complex network. The formula $Z = R X_c / \sqrt{R^2 + X_c^2}$ is used for frequencies up to 1 MHz by substituting the values given for R and C. Above 1 MHz, the output impedance is greater than the formula would indicate.

** Output current can be modulated 100% up to 50 Hz; percent modulation decreases

linearly to 10% at 500 Hz.

†† For operation above 40°C the maximum output current must be reduced linearly to 80% of rating at 55°C (maximum temperature).

Δ Minimum voltage obtainable with voltage limit control is 0.5 V.

POWER SUPPLIES

Special Purpose: High Voltage Output

Models 6515A-6525A

- Short circuit proof
- Precise voltage control—four decade thumbwheel or switch and vernier
- Convection cooling

- Floating output—can be used as a positive or negative source
- Front-panel meters
- Bench or rack mounting

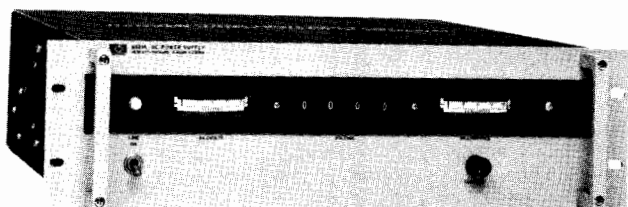

6521A, 6525A

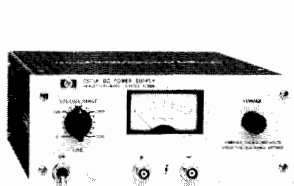

6515A

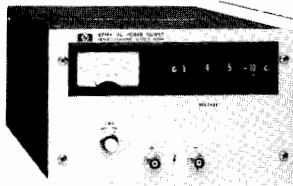

6516A

Description

6521A 6525A

This series of high performance power supplies has broad application both in the laboratory and in the system. They have sufficient output current to power devices such as TWT's, klystrons, magnetrons, backward-wave oscillators, high-power gas lasers, electron-beam welding devices, etc. Output voltage is set easily and precisely by a three-decade thumbwheel switch plus a thumbwheel vernier providing 0.002% resolution. In constant voltage operation, a single-turn current control allows the current limit point to be set to any value within the current rating. In constant current operation, the current control varies the output current while the voltage controls (thumbwheels) provide an adjustable voltage limit. The supplies are protected against reverse voltage that could be generated by an active load. Protection from reverse current requires pre-loading the supply with a dummy load to ensure that the supply outputs current through the entire operating cycle of the load. Either the positive or negative terminal may be grounded or the supply may be operated floating at up to 200 V above ground.

Power: 115 V ac \pm 10%, 48–440 Hz, 4 A, 270 W (230 V ac available on special order).

Weight: net, 19 kg (42 lb). Shipping, 28.5 kg (63 lb).

Size: 133 H x 483 W x 457 mm D (5.25" x 19" x 18").

6515A and 6516A

These high-voltage power supplies are lower in cost and output power than the 6521A-6525A supplies. Their small size, low price, and short-circuit-proof operation make them excellent high-voltage laboratory supplies, or high-voltage systems supplies for lower current requirements.

Model 6515A employs a sixteen-position rotary switch and a ten-turn vernier control to adjust the output voltage. The rotary switch selects output voltage increments from 1 to 1500 V in 100-volt steps; the vernier control permits fine adjustment (100 mV resolution) over any 100-volt span. Model 6516A uses a three-decade thumbwheel switch plus a thumbwheel vernier for convenient and precise (1.0 V resolution) output voltage control.

Non-adjustable current-limit protection is provided on both models. On Model 6516A, the current-limit point is fixed at approximately 8 mA. On Model 6515A, the current limit value varies with the selected output voltage range as follows (voltage range/current limit): 0-300 V/7.5 mA, 400-700 V/65 mA, 800-1100 V/32 mA, 1200-1500 V/25 mA. Both supplies are protected against reverse voltage that could be generated by an active load. Pre-loading is necessary to protect the supplies from reverse current. Either the positive or negative terminal may be grounded or the supply may be operated floating at up to 1000 V above ground. Units are packaged in half-rack-width cases. They may be bench operated or mounted individually or in pairs using accessory rack-mounting kits.

Power: 6515A: 115 V ac \pm 10%, 60 \pm 0.3 Hz, 016 A, 19 W. (230 V ac available on special order) 6516A: 115 V ac \pm 10%, 57-63 Hz, 1 A, 40 W.

Weight: 6515A: net, 4.1 kg (9 lb). Shipping, 5.0 kg (11 lb). 6516A: net, 7.7 kg (17 lb). Shipping, 9.5 kg (21 lb).

Size: 6515A, 89 H x 216 W x 299 mm D (3.50" x 8.50" x 11.75"). 6516A, 133 H x 216 W x 406 mm D (5.25" x 8.50" x 16").

Option Descriptions

019: 230 V ac \pm 10%, 50 \pm 0.3 Hz, single phase input. Consists of replacing input transformer, line cord and fuse.

Option 019 applies only to models 6515A
6516A

J08: model 6521A may be operated on 230 V ac, 48-63 Hz, only through the use of an external accessory 230 V to 115 V step-down transformer. Suitable transformer with built-in receptacle, line cord and grounding-type plug may be ordered with the power supply as a Special Option. Contact your local HP Field Engineer for ordering information.

J13: same as J08, for model 6525A

910: one additional operating and service manual shipped with each power supply

6515A-6516A

6521A-6525A

Accessories

14513A: rack kit for one 6515A

14523A: rack kit for two 6515A's

14515A: rack kit for one 6516A

14525A: rack kit for two 6516A's

RATINGS			PERFORMANCE										GENERAL	
DC Output		Model	Load Effect		Source Effect		PAR (rms/p-p)		Drift		Resolution		Options	
Volts	mA		Voltage	Current	Voltage	Current	Voltage	Current	Voltage	Current	V	C		
0-1000	0-200	6521A	0.005% or 20 mV	2% or 1 mA	0.005% or 20 mV*	1 mA	1 mV/150 mV	2 mA rms	0.036% + 3 mV	0.25% + 0.5 mA	20 mV	0.6 mA	J08	
0-1600	5	6515A	0.01% or 16 mV*	**	0.01% or 16 mV*	**	2mV/15 mV	**	0.05% + 5 mV	**	100 mV	**	15, 19	
0-3000	6	6516A	0.01% or 16 mV*	**	0.01% or 16 mV*	**	1 mV/15 mV	**	0.05% + 5 mV	**	1 V	**	19	
0-4000	0-50	6525A	0.005% or 20 mV*	2% or 1 mA*	0.005% or 20 mV	1 mA	1 mV/150 mV	500 μ A rms	0.036% + 3 mV	0.25% + 0.12 mA	80 mV	0.15 mA	J13	

* whichever is larger.

** This feature is not available.

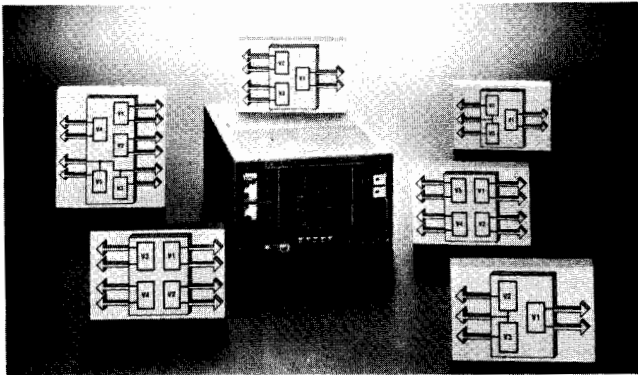

20 kHz Switching: Up to 5 Outputs & 550 Watts

The need for more features and the needs for end-product compliance with new safety and EMI regulations are placing more demands on your power supply. To help meet these demands, HP has a family of multiple-output 20 kHz switching power supplies. These supplies provide up to 100 amperes with voltages ranging from 5 to 24 volts. The basic design has the flexibility to allow modification to meet your requirements when the total power from all outputs combined is under 550 watts.

The minimum input voltage is 87 Vac to tolerate brownout conditions and to ensure performance where nominal line voltages are low. Carryover time is 40 milliseconds at nominal line voltage and full load.

Switching Supplies

110 Watts, Convection Cooled

Model	Output Voltage (Vdc)	Maximum Current (A dc)	
		40°C	50°C
63005E	5	22	18
63315E	5	18	15
	+15	2	1.6
	-15	2	1.6

300 Watts, Fan Cooled

62605L	5	60	50
--------	---	----	----

500 Watts, Fan Cooled

62605M	5	100	87
62615M	15	35	30

550 Watts Fan Cooled

63312F	5	50	42
	+12 to 15	10	8
	-12 to 15	10	8
63330F	5	50	42
	12 to 15	10	8
	12 to 15	10	8
63331F	5	85	70
	+12	5	4
	-12	5	4
63340F	5	50	42
	12 to 15	10	8
	12 to 15	10	8
	5	5	4
63341F	5	35	29
	24	5	4
	12	10	8
	12	6	5
63350F	5	35	29
	24	5	4
	-12	9	7
	12	6	5
	-5	1	1

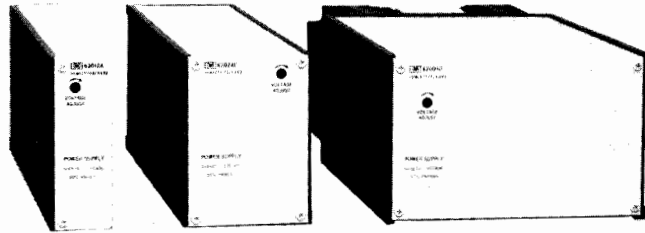

Linear Regulated

Single and dual output modular power supplies are offered in this series of linear regulated modules. Packaged in modules which are 1/8, 1/4, and 1/2-width fractions of the standard 19-inch rack system, and with uniform height and depth, they provide design flexibility. Modular combinations mounted in the HP 62410A tray developed power systems for rack installations, or the modules may be mounted individually in equipment.

Protection from overcurrent, overtemperature, reverse voltage, and open remote voltage sensing terminals is standard on all models. A built-in overvoltage protection crowbar is optional. Output voltage tracking accuracy is within $\pm 1\%$ on the dual output models.

Linear Supplies, AC to DC

10-20 Watts, Convection Cooled

62005A	5	2.0	2.0
62012A	12	1.5	1.5
62015A	15	1.25	1.25
62024A	24	0.75	0.75

40-90 Watts, Convection Cooled

62005E	5	8	8
62012E	12	6	6
62015E	15	5	5
62024E	24	3.75	3.75

80-200 Watts, Convection Cooled

62005G	5	16	16
62012G	12	12	12
62015G	15	10	10
62024G	24	7.5	7.5

30-140 Watts, Dual Output, Convection Cooled

62212A	± 12	1.41/1.25	—
62215A	± 15	1.25/1.1	—
62212E	± 12	3.3/3	—
62215E	± 15	3/2.75	—
62212G	± 12	6/5	—
62215G	± 15	5.2/4.5	—

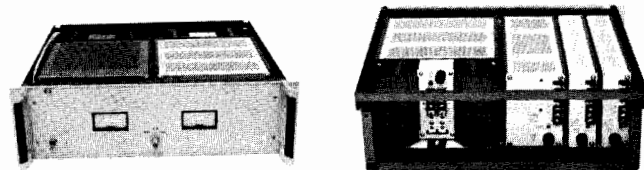

Custom Systems

Custom power systems can be assembled by installing suitable combinations of single and dual-output linear supplies and switching regulated supplies in rack mounting trays. If desired, Hewlett-Packard will assemble, wire, and test complete power supply systems to customer specifications using these modular power supplies and rack mounting accessories. Meters, switches, input and output connectors, and other components will be installed to meet your specific needs. Consult your local Hewlett-Packard Field Engineer for price and delivery information.

RECORDERS, PLOTTERS & PRINTERS

General Recorder Information

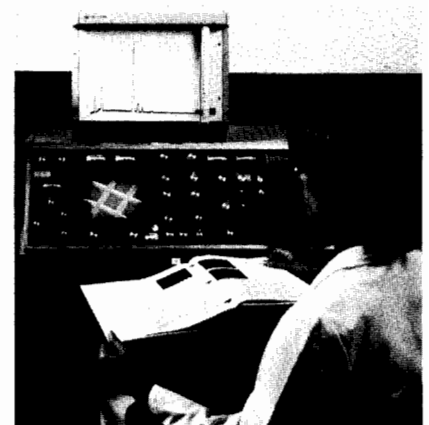
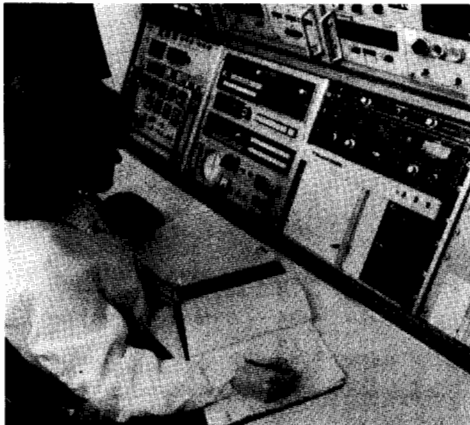

Introduction

Wherever the need exists for measuring and collecting data with precision, there is a need for precise hardcopy graphics. Hardcopy graphics with a top quality recorder or plotter can improve your measurement system in several ways: plots provide permanent post-test results for many documentation needs and can be filed and retrieved as needed; they can be presented on transparencies for more effective communication during training sessions or meetings; they save time over manual graphing and save cost over scope camera film; and, with the help of high resolution plots which record data clearly and accurately, trends, relationships and variations are easy to spot.

Hewlett-Packard offers a wide selection of recorders and plotters that capture and display data accurately, quickly, and consistently. For measurements made from analog input signals, X-Y, strip chart, and oscillographic recorders create permanent hardcopy graphs drawn on gridded paper using one or two pens. For hardcopy from digital data input, graphics plotters with the appropriate hardware and software can draw grids, annotate charts, and use many line types and colors to differentiate data. Whether your application is manufacturing, engineering, education, business management, or medicine our recorders and plotters offer a choice of performance features to meet your requirements.

Some of the criteria for selecting the recording/plotting device for your measurement hardcopy requirements are discussed below. And, on pages 253-255, we have provided a table which will help you choose the best recorder or plotter for your HP instrument.

Selecting an X-Y Recorder

X-Y recorders plot Cartesian coordinate graphs from low frequency analog signals. There are three factors to consider in selecting an X-Y recorder in addition to reliability: static performance, dynamic performance, and features.

Static performance: static performance relates to a recorder's response to dc voltages and very low frequency input signals. It includes accuracy and resolution. Accuracy is the degree of distortion of the recorded signal. Accuracy and resolution of the trace are functions of the electronic and mechanical characteristics of the recorder and also of its dynamic performance. The type of input signal will determine the range of sensitivity (input voltage) required.

Dynamic performance: dynamic performance is a function of two characteristics: slewing speed and acceleration. Slewing speed is defined as the maximum speed attainable by the pen along either the X- or Y-axis. Its main contribution is the ability to record high amplitude, low frequency signals. Acceleration is defined as the peak pen acceleration when the pen responds to a step input. Acceleration's main contribution is the ability to respond to low amplitude, high frequency signals. As an instrument's rated acceleration decreases, response is more and more limited by acceleration, and slewing speed becomes less significant. High dynamic performance is essential to

the capture of rapid, transient signal inputs. The types, speed, frequency, and range of the input signals determine the required dynamic performance characteristics.

Features: the importance of other features is determined by the application in which the recorder will be used. In some cases there is a trade off. Unit size is one example. The larger the unit, the easier it is to scale for recognition and interpretation of the trace, but the more space is required to house the recorder. Selecting a 1- or 2-pen system depends on whether one or two independent variables are being recorded versus another variable. Use of a time base feature is determined by the need to record the variable or variables versus time. Other standard or optional features available on all HP X-Y recorders include electrostatic holddown, zero offset, and rack mounts.

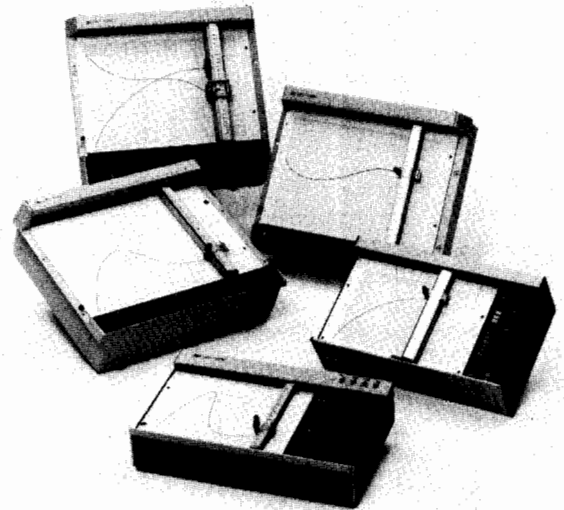

X-Y Recorders

Chart Size	Dynamic Performance	Sensitivity	Special Features	Model Number	Page Number
Large chart 28 x 42 cm (or 11 x 17 in.)	Very high	High	TTL remote control	7045B	258
	Very high	High	2 pens, TTL remote control	7046B	258
	High	High	TTL remote control	7044B	258
Small chart 22 x 28 cm (or 8.5 x 11 in.)	High	Medium	TTL remote control, time base	7015B	256
	Low	Medium		7035B	257

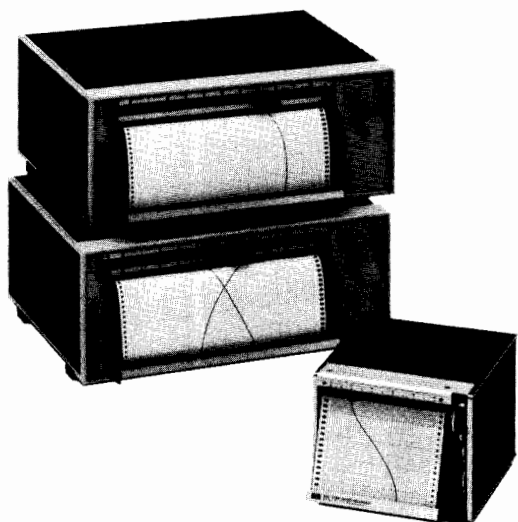

Selecting a Strip Chart Recorder

Strip chart recorders produce permanent records of slowly varying analog signals versus time. Selection criteria should include chart speeds and writing system.

Chart speeds: recording speeds vary with each recorder capable of performing at multiple, user-selected speeds. Fast speeds capture rapid, close signals, and slow speeds are ideal for long-term recording and paper economy. The range selected will vary, based on your requirements and data input volume.

Writing systems: a thermal writing system, which seldom requires pens to be changed, is ideal for long-term unattended operation; an ink writing system contains durable stainless steel or convenient disposable pens. Both systems provide a clean, distinct trace. All 2-pen models permit both channels to use the full resolution of the chart width simultaneously, as the pens can overlap on the same chart without interference.

Features: standard features on all models include chart tables that tilt at three angles, front-panel thumbwheels that advance chart paper, chart storage, and user-oriented manuals. The series offers models with 1 and 2 pens, modular construction, compact size, event marker options, and remote capability.

Strip Chart Recorders

Grid Width	Chart Speeds	Special Features	Model No.	Page No.
25cm (10 in.)	8 speeds plus remote control (speed proportional to input pulse rate)	2 pens, thermal writing option, TTL remote control	7132A*	261
25 cm (10 in.)	8 speeds plus remote control (speed proportional to input)	1 pen, thermal writing option, TTL remote control	7133A*	261
12 cm (5 in.)	8 speeds	1 pen, compact	680	260

*For OEM applications, single-range, single-speed models are available (7130A and 7131A).

Selecting an Oscillographic Recorder

Direct writing oscillographs accurately record analog signals in excess of 100 Hz, whereas strip chart recorders are limited to about 1 Hz. Oscillographic recorders utilize a 40 mm channel width as opposed to the 125 or 250 mm channel width of the typical strip chart recorder. The selection of an oscillograph is determined by the number of channels and the type of writing system.

Number of channels: HP oscillographic recorders are available in 4 or 8 channels. All channels provide precise time correlation relative to the other channels.

Writing system: ceramic thermal pen tips can last the life of the recorder; pen structure is stainless steel to eliminate fatigue failures, including the types that could be caused by sustained violent signals.

Features: other features include a high pen resonance frequency, remote chart speed control, accessible preamplifier outputs, and the same 5-pin shielded input connectors on all preamplifiers. A Z-fold chart paper pack loads easily for convenient data review and storage.

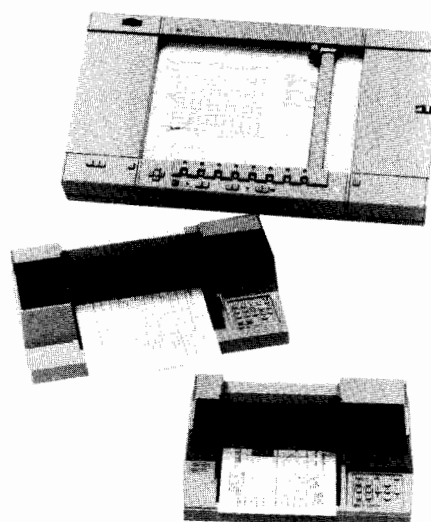

Oscillographic Recorders

Number of Channels	Writing Method	Number of Chart Speeds	Special Features	Model No.	Page No.
8	Thermal	8, 16 optional	Uses 8800-series plug-ins	7418A	262
4	Thermal	8, 16 optional	Uses 8800-series plug-ins	7414A	262

Selecting a Graphics Plotter

Graphics plotters provide multi-color, professional quality hard-copy for digital data input. Selection is based on line quality, speed, output size, intelligence features, available software, interface, and budget considerations.

Line quality and speed: all HP plotters provide optimal line quality with a high mechanical resolution of 0.001 inches and a repeatability of 0.004 inches. These specifications assure smooth lines and characters. They perform at high speeds and allow speed adjustment for writing on different media.

Output size: your application will determine the output size required. Notebook size (8.5 x 11 in.) color plots are ideal for reports and overhead transparencies. Use them to summarize data, identify trends, compare results, and highlight exceptions. The larger 11 x 17 inch plots are especially useful for time lines, PERT charts, schematics, engineering drawings, and other applications where you need to show visual detail.

Intelligence and software: HP plotters (except 7221T) feature built-in HP-GL (Hewlett-Packard Graphics Language) commands to control a large number of plotter functions. This plotter intelligence frees your system's CPU for other jobs and simplifies the user's programming task. Graphics software packages are available for use on all of HP's graphics plotters. See page 635 for more details.

Graphic Plotters

Features	Media	Media Size	Model No.	Interface	Page
High-quality plotters for budget-sensitive applications. Two-pen (7470A) or six-pen (7475A) programmable. Paper-moving technology. Use fiber-tip pens.	Paper or transparency film	210 x 297 mm (8.5 x 11 in.)	7470A Option 001	RS-232-C/ CCITT V.24	628
			7470A Option 002	HP-IB (IEEE-488)	
			7470A Option 003	HP-IL*	
		210 x 297 mm (8.5 x 11 in.) and 297 x 420 mm (11 x 17 in.)	7475A Option 001	RS-232-C/ CCITT V.24	628
			7475A Option 002	HP-IB (IEEE-488)	
8-Pen flatbed plotters with automatic paper advance for unattended operation. Compacted binary language in 7221T. Use fiber-tip and drafting pens.	Paper, transparency film, vellum, double-matte polyester film	Any size up to 297 x 420 mm (11 x 17 in.)	7220T 7221T	RS-232-C/ CCITT V.24	630
			9872T	HP-IB (IEEE-488)	

*HP-IL is a serial interface for low cost portable systems.

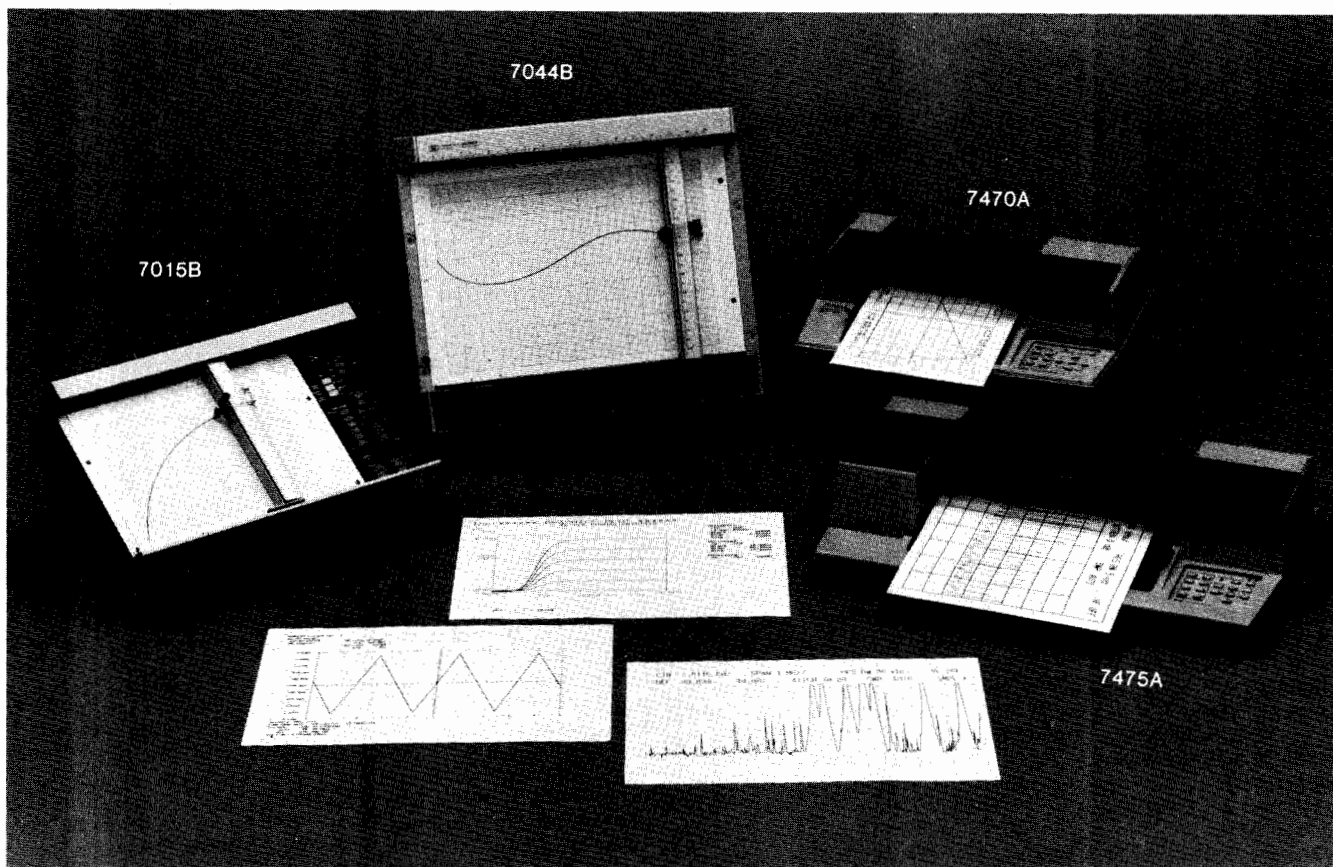

Recommended Solutions

In the following three pages you will find a selection guide listing the graphics plotter and/or X-Y recorder which is best suited for your Hewlett-Packard measurement instrument. The table includes a description of the instrument's "output capability". This description indicates whether your instrument can be connected directly to the recorder or plotter to produce graphics output or if a controller and software must first be added.

HP instruments designed with microprocessors can control plotting from front panel buttons or menu-driven softkeys. These instruments allow you to send graphics data directly from your instrument to a plotter. If your instrument has this capability, it will be listed with a "direct to plotter" output capability.

Other HP measurement instruments require the appropriate controller and software in order to send graphics output to the plotter. These instruments are indicated by "indirect to plotter" output capability. If the system requires or includes a particular controller, that controller is also indicated. Software availability varies from system to system; it is often included with the controller/instrument but in some cases, must be created by the user. When "indirect to plotter" is indicated, consult your sales representative for recommendations.

Alternative Solutions

The recommended model listed in the selection guide will provide you with a good solution for your measurement hardcopy requirements. However, features available in other models may better suit your present and future needs. You can choose models which offer more flexibility, or, for budget sensitive applications, choose a model

with less flexibility but lower initial cost. The following table poses some alternative solutions to those recommended in the selection guide.

	X-Y Recorder	Graphics Plotter
When the recommended model is...	7044B <ul style="list-style-type: none"> • 1 pen • High performance • Any chart size up to A3 (11 x 17 in.) 	7475A <ul style="list-style-type: none"> • 6 pen carousel • Two chart sizes, A (8.5 x 11 in.) and B (11 x 17 in.)
Additional flexibility will come from...	7046B <ul style="list-style-type: none"> • 2 pens • Very high performance • Any chart size up to A3 (11 x 17 in.) <p style="text-align: center;">OR</p> 7045B <ul style="list-style-type: none"> • 1 pen • Very high performance • Any chart size up to A3 (11 x 17 in.) 	9872T <ul style="list-style-type: none"> • 8 pen automatic selection • Any paper, vellum, polyester or transparency film size up to A3 (11 x 17 in.) • Drafting ink pens in addition to multicolor fiber-tip pens • Automatic chart advance and paper cutting for unattended plotting
Less flexibility but lower initial cost will come from...	7015B <ul style="list-style-type: none"> • 1 pen • Medium performance • Any chart size up to A4 (8.5 x 11 in.) 	7470A <ul style="list-style-type: none"> • 2 pen automatic selection • One chart size only-A4 (8.5 x 11 in.)



X-Y Recorder and Graphics Plotter Selection Guide for HP Instruments

HP Instrument	Output Capability "Indirect to plotter" requires an appropriate controller and software.	X-Y Recorder Outputs		Recommended Model
		Voltage	Penlift	
141T Spectrum Analyzer System	Direct to recorder	X -5 to 5 V Y 0 to -8 V	YES (14 V pen up, 0 V pen down)	7015B
415E SWR Meter	Direct to recorder	X 0 to 1 V	NO	7044B
432A/B/C Power Meters	Direct to recorder	Y 0 to 1 V	NO	7044B
436A Power Meter (with Option 024)	Direct to recorder	Y 0 to 1 V	NO	7044B
853A Spectrum Analyzer Display	Direct to recorder	X -5 to 5 V Y 0 to .8 V	YES (15 V pen up, 0 V pen down)	7044B
	Direct to plotter			7475A
1040A High Speed Spectrophotometric Detector	Indirect to plotter System includes HP 85			7470A
1090A Liquid Chromatograph	Indirect to plotter System includes HP 85B			7470A
1347A HP-IB Display	Indirect to plotter			7475A
1980B/S Oscilloscope Measurement Systems (with 19860A Digital Waveform Storage and 19811A Plot/Sequence ROM)	Direct to plotter			7475A
2250S Data Acquisition/ Control System	Indirect to plotter			7475A
3046A/B/S Selective Level Measuring Systems	Indirect to plotter			7475A
3047A/B/S Spectrum Analyzer Systems	Indirect to plotter			7475A
3054A/C/DL/S Data Acquisition Systems	Indirect to plotter			7475A
3056DL/S Data Acquisition Systems	Indirect to plotter			7470A
3314A Function Generator	Direct to recorder	X -5 to 5 V	YES	7044B
3325A Synthesizer/Function Generator	Direct to recorder	X 0 to 10 V	YES TTL	7044B
3335A Synthesizer/Level Generator	Direct to recorder	X 0 to 2 V	NO	7044B
3336A/B/C Synthesizer/Level Generator	Direct to recorder	X 0 to 10 V	YES TTL	7044B
3357 Lab Automated System	Indirect to plotter System includes HP 1000			7475A
3421A Data Acquisition/ Control Unit	Indirect to plotter			7470A
3495A/97A/S Data Acquisition/ Control Units/System	Indirect to plotter			7475A
3575A Gain/Phase Meter	Direct to recorder	Y1 10 mV/degree Y2 10 mV/dB	NO	7046B
3580A Spectrum Analyzer	Direct to recorder	X 0 to 5 V Y 0 to 5 V	YES contact closure to ground during sweep	7044B
3581A Wave Analyzer 3581C Selective Voltmeter	Direct to recorder	X 0 to 5 V Y 0 to 5 V	YES contact closure to ground during sweep	7044B
3582A Spectrum Analyzer	Direct to recorder	X 0 to 5.25 V Y 0 to 5.25 V	YES contact closure during sweep	7044B
	Indirect to plotter			7475A
3585A Spectrum Analyzer	Direct to recorder	X 0 to 10 V Y 0 to 10 V	YES TTL	7044B
	Indirect to plotter			7475A



RECORDERS, PLOTTERS & PRINTERS

General Recorder Information (cont.)

HP Instrument	Output Capability "Indirect to plotter" requires an appropriate controller and software.	X-Y Recorder Outputs		Recommended Model
		Voltage	Penlift	
3586A/B/C Selective Level Meter	Indirect to plotter			7475A
3712A MLA Receiver	Direct to recorder	X -5 to 5 V Y -5 to 5 V	YES	7015B
3724A/25A/26A Baseband Analyzers	Direct to plotter			7475A
3747B Selective Level Measuring Set (with Option 040)	Direct to recorder	X 0 to 5 V Y 0 to 5 V	YES (open collector, 50 V max)	7044B
3770B Telephone Analyzer	Direct to recorder (Special graph paper available)	X 0 to 5 V Y -5 to 5 V	NO	7044B
4061A/S Semiconductor Test System	Indirect to plotter			7475A
4062A/S Semiconductor Parametric Test System	Indirect to plotter			7475A
4140B pA Meter/DC Voltage Source	Direct to recorder	X -10 to 10 V Y -5 to 5 V	YES	7044B
	Indirect to plotter			7475A
4145A Semiconductor Parameter Analyzer	Direct to plotter			7475A
4191A RF Impedance Analyzer (with Option 004)	Direct to recorder	X 0 to 1 V Y1 0 to 1 V Y2 0 to 1 V	NO	7046B
	(Option 004 not required) Indirect to plotter			7475A
4192A LF Impedance Meter	Direct to recorder	X -1 to 1 V Y -1 to 1 V	YES TTL (low level at pen down)	7044B
	Indirect to plotter			7475A
4193A Vector Impedance Meter	Direct to recorder	X 0 to 1 V Y1 0 to 1 V Y2 -1 to 1 V	YES	7046B
	Indirect to plotter			7475A
4280A 1 MHz C Meter/C-V Plotter	Direct to recorder	X -10 to 10 V Y -10 to 10 V	YES	7044B
	Indirect to plotter			7475A
4800A Vector Impedance Meter	Direct to recorder	X 0 to 1 V Y1 0 to 1 V Y2 -.9 to .9 V	NO	7046B
4943A Transmission Impairment Measuring Set	Direct to recorder	X -1 to 10 V Y 0 to 10 V	YES (5 V pen up, 0 V pen down)	7044B
5180A Waveform Recorder	Direct to recorder	X -1 to 0 V Y -1 to 0 V	YES (0 V and 5 V)	7044B
	Direct to plotter			7475B
5390A Frequency Stability Analyzer	Indirect to plotter System includes HP 9825B			7475A
5420B Digital Signal Analyzer	Direct to plotter			7475A
5423A Structural Dynamics Analyzer	Direct to plotter			7475A
5427A Digital Vibration Test Control System	Direct to plotter			7475A
5451C Digital Fourier Analysis System	Direct to plotter			7475A
55286S/88S Dimensional Metrology Analysis Systems	Indirect to plotter			7475A
6901S Measurement and Analysis System	Direct to plotter			7475A
6940B/42A Multiprogrammers	Indirect to plotter			7475A
6942S Computer Aided Test System	Indirect to plotter			7475A
8116A Pulse/Function Generator (with Option 001)	Direct to recorder	X 0 to 10 V (1.5 V/decade)	YES TTL	7044B
8165A Programmable Signal Source (with Option 002)	Direct to recorder	X 0 to 2.99 V (1 V/decade)	NO	7044B
8340A Synthesized Sweeper	Direct to recorder	X 0 to 10 V	YES	7044B
8350B Sweep Oscillator	Direct to recorder	X 0 to 10 V	YES	7044B



HP Instrument	Output Capability "Indirect to plotter" requires an appropriate controller and software.	X-Y Recorder Outputs		Recommended Model
		Voltage	Penlift	
8405A Vector Voltmeter	Direct to recorder	Y1 0 to 1 V Y2 -5 to 5 V	NO	7046B
8407A/8410B Network Analyzer System — The following plug-ins are part of the 8407A and 8410B systems:				
8412A Phase-Magnitude Display	Direct to recorder	Y1 50 mV/dB Y2 10 mV/degree	NO	7046B
8414A Polar Display	Direct to recorder	X -2.5 to 2.5 V Y -2.5 to 2.5 V	NO	7044B
8408B/S Automatic Network Analyzer	Indirect to plotter			7475A
8409C/S Automatic Network Analyzer	Indirect to plotter			7475A
8410B (see 8407)				
8450/51A Diode Array Spectrophotometers	Direct to plotter			7470A
8505A Network Analyzer	Direct to recorder	X 0 to 7.5 V Y -1.25 to 1.25V	YES 200 mA current sink	7044B
	Indirect to plotter			7475A
8507B/C/S Automatic RF Network Analyzer System	Indirect to plotter			7475A
8557A/58B/59A Spectrum Analyzers	Direct to recorder	X -5 to 5 V Y 0 to .8 V (with 853A and 180 mainframes)	YES (15 V pen up, 0 V pen down)	7044B
	With 853A Display Direct to plotter			7475A
8565A Spectrum Analyzer	Direct to recorder	X -5 to 5 V Y 0 to .8 V	YES (15 V pen up, 0 V pen down)	7044B
8566A/S/68A/S Spectrum Analyzers	Direct to recorder	X 0 to 10 V Y 0 to 10 V	YES (15 V pen up, 0 V pen down)	7044B
	Indirect to plotter			7475A
8569B Spectrum Analyzer	Direct to recorder	X -5 to 5 V Y 0 to .8 V	YES (15 V pen up, 0 V pen down)	7044B
	Direct to plotter			7475A
8620C Sweep Oscillator	Direct to recorder	X 0 to 10 V	YES (5 V pen up)	7044B
8660C Synthesized Signal Generator	Direct to recorder	X 0 to 8 V	YES (with Option H24)	7044B
8662A/63A/73A Synthesized Signal Generators	Direct to recorder	X 0 to 10 V	YES TTL	7044B
8683A/B/84A/B Signal Generators	Direct to recorder	X1 0 to 10 V X2 0 to 10 V	NO	7044B
8750A Storage-Normalizer	Direct to recorder	X 0 to 1 V Y -4 to 4 V	YES (open collector driver, 20 V max)	7044B
8754A Network Analyzer	Direct to recorder	X 0 to 1 V Y -.4 to .4 V	YES (5 V pen up, 0 V pen down)	7044B
8755S Frequency Response Test System	Direct to recorder	Y -4 to 4 V	YES (open collector driver, 20 V max)	7044B
8756A/S Automatic Scalar Network Analyzer	Direct to plotter			7475A
8900C/D Peak Power Meter	Direct to recorder	Y 0 to 1 V	NO	7044B
8903A Audio Analyzer	Direct to recorder	X 0 to 10 V Y 0 to 10 V	YES	7015B
	Indirect to plotter			7475A
8953A/S Transceiver Test System	Indirect to plotter			7475A
8955A/S RF Test System	Indirect to plotter			7475A
8970A Noise Figure Meter	Direct to recorder	X 0 to 6 V Y 0 to 6 V	YES TTL	7044B
	Indirect to plotter			7475A

RECORDERS, PLOTTERS & PRINTERS

Low-Cost, Flexible X-Y Recorders

Models 7010B, 7015B

- Low cost of ownership
- Choice of optional features

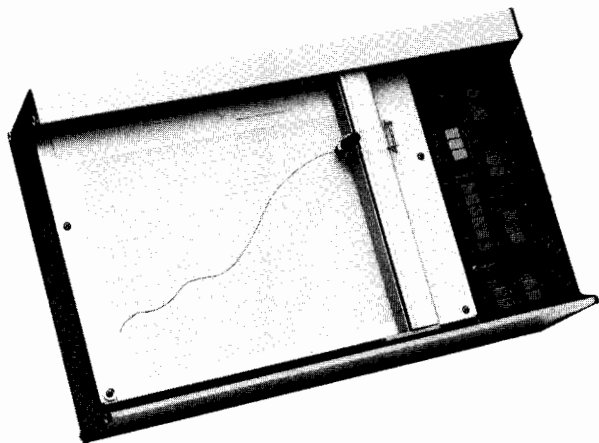

- Low price
- Full capability

7015B

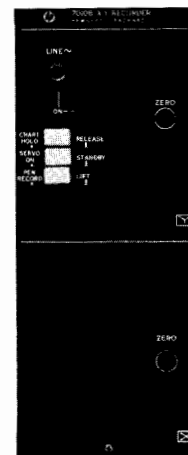

7010B
Control
Panel

Models 7010B and 7015B X-Y Recorders

The 7010B and 7015B are low-cost, one-pen X-Y recorders that allow charting on paper sizes up to ISO A4 or 216 x 280 mm (8.5 x 11 in.). All paper sizes up to the maximum are held securely by the trouble-free electrostatic paper hold-down. The units are mounted in sturdy cases made from single castings, assuring mechanical alignment and long life, even in rugged environments. Designed for the OEM market, the 7010B recorder features low cost, compact design, and a selection of options. The 7015B provides recording for a wide range of laboratory uses where there is a need for full capability at reasonable cost.

The 7010B, for OEM applications, features electrical and mechanical flexibility by providing a choice of X- and Y-axis sensitivities and X-axis sweep options. In addition, there are optional time base sweeps with remote TTL triggering, input filters, electric pen lift with TTL remote control, control panel, and carrying case.

The 7015B has a full complement of capabilities. The standard features include an internal time base with sweep selections from 5 seconds to 20 minutes. The time base provides automatic pen control and accepts remote triggering from sweep start and reset. Also included are matched input filters, remote pen lift, and TTL-level remote control. The 7015B accepts TTL-level and low current (5 mA) contact closure for easy interface with external equipment.

7010B, 7015B Performance Specifications

Input Voltage

7010B: single range, metric: 50 mV/cm, English: 0.1 V/in.

7015B: metric: 5 mV/cm, 50 mV/cm, 500 mV/cm, English: 0.01 V/in., 0.1 V/in., 1 V/in.; vernier adjustable overlapping all ranges

Time Base

7015B: metric: 0.1, 0.5, 1, 5, 10, 50 s/cm, English: 0.5, 1, 5, 10, 50, 100 s/in.; remote sweep start and reset via TTL level or contact closure

Input Types

7010B: floating rear connector on circuit board

7015B: floating binding posts or circuit board rear connector

Input resistance: 1 M Ω constant

Normal mode rejection: 7015B: greater than 50 dB at 50 and 60 Hz (40 dB/decade roll-off above 60 Hz)

Common mode rejection: 100 dB dc, 90 dB ac (decreases 20 dB/decade step in attenuation); measured with 1 k unbalance in H1 terminal on most sensitive range

Common mode voltage: 40 V dc and peak ac maximum (conforms to IEC 348)

Accuracy: 7010B: $\pm 0.3\%$ of full scale at 25°C (includes linearity and resettability). 7015B: add $\pm 0.2\%$ of deflection when not on most sensitive range; temperature coefficient: $\pm 0.2\%/^{\circ}\text{C}$; time base: 1.5% $\pm 0.1\%/^{\circ}\text{C}$

Resettability: less than 0.2% of full scale

Overshoot: less than 2% of full scale

Slewing speed: greater than 50 cm/s (20 in./s)

Zero set: 7015B: Zero may be placed anywhere on writing area or electrically off-scale up to one full scale from zero index; adjustment by 10-turn high resolution control

Environment: operating temperature 0°C to 55°C; 95% RH (40°C)

7010B, 7015B General Specifications

Writing system: fiber-tipped disposable pen

Writing area: 18 x 25 cm (7 x 10 in.)

Platen size: holds up to ISO A4 (21 x 30 cm) and 8.5 x 11 in.

Size: 267 H x 432 W x 135 mm D (10.5" x 17" x 5")

Pen Lift

7010B: manual (optional TTL remote control)

7015B: electric (remote via TTL level or contact closure)

Power: switch selectable for 100, 120, 220, 240 V ac $\pm 5 - 10\%$; 47.5 to 440 Hz; 70 VA maximum

Weight: net, 7.2 kg (16 lb). Shipping, 10 kg (22 lb)

7010B Options

001 Metric calibration

002 Control panel

003 Electric pen lift

004 Deletes recorder case

005 X-axis single sensitivity 5 mV/cm (10 mV/in.)

006 X-axis single sensitivity 0.5 V/cm (1 V/in.)

007 Y-axis single sensitivity 5 mV/cm (10 mV/in.)

008 Y-axis single sensitivity 0.5 V/cm (1 V/in.)

009* X-axis sweep rate of 0.5 s/cm (1 s/in.)

010* X-axis sweep rate of 5 s/cm (10 s/in.)

011 Carrying case (not for shipping use)

012 Input filter (both axes)

013 Rear connector (37-pin subminiature "D")

908 Rack mount

*Options 009 and 010 include electric pen lift

7015B Options

001 Metric calibration

004 Carrying case (not for shipping use)

908 Rack mount

Ordering Information

7010B OEM X-Y Recorder

7015B Lab X-Y Recorder

OEM discounts available

- Precision recording
- Time base available
- Floating guarded inputs

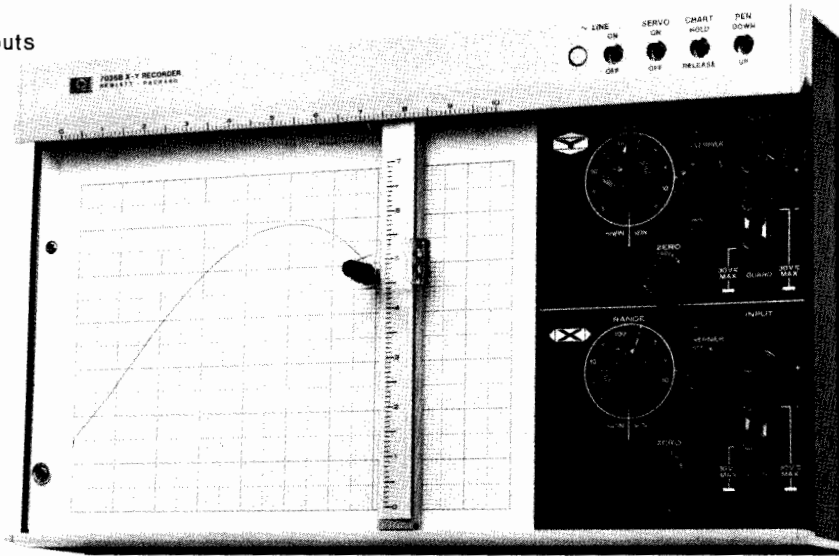

7035B

Model 7035B X-Y Recorder

The 7035B combines precision with low cost and general-use design to provide users with one X-Y recorder that serves most recording needs where medium dynamic performance is a requirement. Compact in design, the 7035B is well adapted to rack mounting with the addition of only two optional wing brackets. Other features are silent, trouble-free electrostatic paper holddown for paper sizes up to 216 x 280 mm (8.5 x 11 in.); floating guarded inputs to help eliminate the common mode voltage effects that are troublesome when recording from low level sources; and disposable pens with self-contained ink supply to allow simple, one-step replacement of ink, tip, and color.

Input connectors on the 7035B accept both open wire and plug-type connectors. In addition, the recorder provides five calibrated ranges (0.4 mV/cm to 4 V/cm) for each axis; signal scaling for full-scale deflection, and high input impedance (1 megohm, except the first two ranges).

Model 17108A Time Base

The 17108A is a self-contained external time base that operates on either axis of the 7035B. By simply plugging in the 17108A, the 7035B is provided with five sweep speeds from 0.2 to 20 s/cm (0.5 to 50 s/in.). This module, powered by a single self-contained battery, is controlled by its own six-position range switch and three-position mode switch.



17108A Option 002 mounted on recorder

17108A Specifications

Sweep speeds: 0.2, 0.4, 2, 4, 20 s/cm (0.5, 1, 5, 10, 50 s/in.)
Accuracy: 5% of recorder full scale
Linearity: 0.5% of full scale (20°C to 30°C)
Output voltage: 0 to 1.5 V
Power: replaceable mercury battery (100 hr)

7035B Performance Specifications

Input ranges: 0.4, 4, 40, 400 mV/cm and 4 V/cm (1, 10, 100 mV/in.; 1 and 10 V/in.). Continuous vernier between ranges
Input types: floating guarded signal pair; rear connector
Input Resistance

Range		Input resistance
0.4 mV/cm	(1 mV/in.)	Potentiometric (essentially infinite at null)
Variable		11 kΩ
4 mV/cm	(10 mV/in.)	100 kΩ
Variable		100 kΩ
40 mV/cm	(100 mV/in.)	1 MΩ
& above	& above)	

Normal mode rejection: > 30 dB at 60 Hz; then 18 dB/octave

Maximum allowable source impedance: 20 kΩ on the most sensitive range; no restrictions on other ranges.

Accuracy: ±0.2% of full scale

Linearity: ±0.1% of full scale

Resetability: ±0.1% of full scale

Zero set: zero may be set up to one full scale in any direction from zero index. Lockable zero controls.

Stewing speed: 50 cm/s (20 in./s) nominal at 115 V.

Common mode rejection: 130 dB at dc & 100 dB at line frequency with up to 1 kΩ between the positive input and guard connection point and attenuator on most sensitive range. CMR decreased 20 dB per decade step in attenuation.

7035B General Specifications

Electrostatic paper holddown: grips 216 x 280 mm (8.5 x 11 in.) charts or smaller. Special paper not required.

Pen lift: electric pen lift capable of being remotely controlled.

Size: 265 H x 445 W x 121 mm D (10.5" x 17.5" x 4.8").

Weight: net, 8 kg (18 lb). Shipping, 10.9 kg (24 lb).

Power: 115 or 230 V ± 10%, 50 to 60 Hz, approximately 45 VA

7035B Options

001 Metric calibration

003 Retransmitting potentiometer on X-axis 5 kΩ ± 3%

908 Rack mount

17108A Options

002 17108A Metric calibration

Ordering Information

7035B General purpose X-Y recorder

17108A Time base plug-in

RECORDERS, PLOTTERS & PRINTERS

High Performance General-Use X-Y Recorders

Models 7044B, 7045B, and 7046B

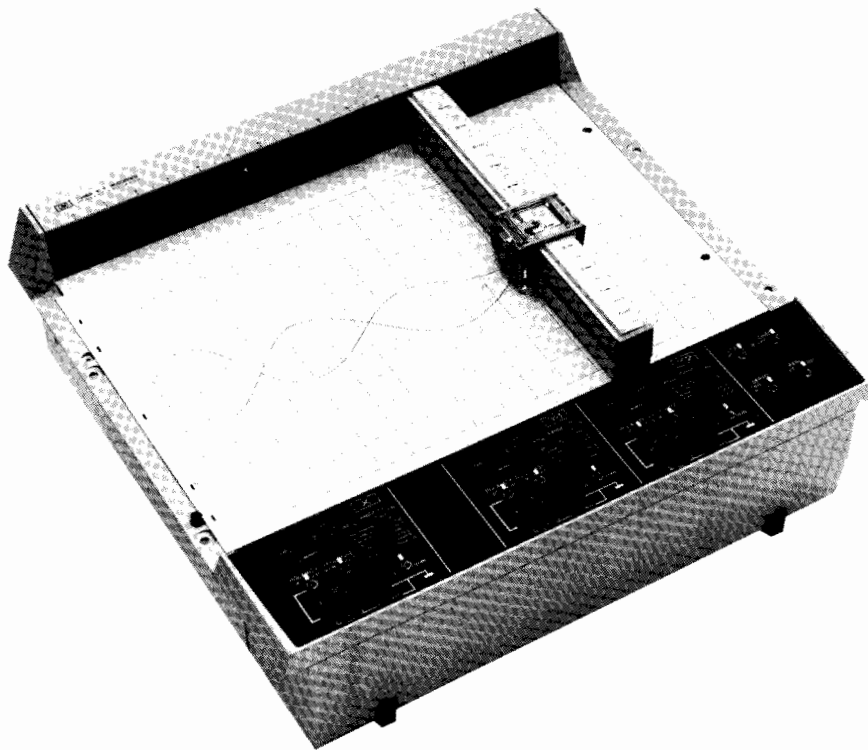

Does your application require maximum general-use capability? Do you need two pens to draw two or three simultaneous variables? . . . Choose the 7046B



Do you have a dedicated application, relatively low frequency requirements, or flexible needs for basic recording? . . . Choose the 7044B

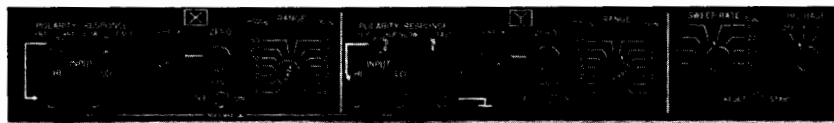

Do you have multi-users and many applications, need fast pen response but have no need to plot two simultaneous Y variables? . . . Choose the 7045B

The 7044B, 7045B, 7046B

This series of general-use X-Y recorders has been designed to satisfy both current and future laboratory applications. The high-level performance and reliability of these recorders are the results of a design philosophy that has evolved through 30 years of Hewlett-Packard experience as a leading manufacturer of X-Y recorders.

Whether the buyer purchases the one-pen (X or T vs Y) 7044B or 7045B or the two-pen (X or T vs Y1 & Y2) 7046B, the recorder will provide the following quality features:

Very high dynamic performance: with a combination of high slewing speed and acceleration, these recorders can capture fast changing signals that an ordinary recorder might miss. For example, the 7045B will, typically, record a signal from dc to 10 Hz at 2 cm peak-to-peak amplitude on either axis.

TTL remote control: with TTL or simple contact closure to ground, a rear connector offers easy interface to measurement systems. TTL provides remote control of sweep, start and reset, pen lift, servo mute, and chart hold. Pen lift, the most important action to be controlled remotely, is also available from a convenient rear-mounted banana jack connector.

Wide chart size range: accepts ISO A3, ISO A4, 8.5 x 11 in., 11 x 17 in., and any paper size under the maximum limit (ISO A3 or 11 x 17 in.). With this capability these recorders can fill a variety of charting needs.

Environmental specifications: each unit is designed to meet exacting Hewlett-Packard environmental specifications. For example, these units meet performance specifications through a temperature range of 0°C to 55°C and at relative humidities up to 95 percent. They also conform to rugged shock and vibration specifications.

Other user-oriented features: with this X-Y recorder line, the two design objectives were to produce precision instruments and to make these units easy to use. Major features include:

- Polarity reverse switch that eliminates need to reverse input leads
- Response switch on 7045B and 7046B that allows recorder response to be slowed to simplify initial set up
- Separate rear connector that provides a convenient remote pen lift control connection
- Built-in hardware that simplifies table or rack mounting



7044B, 7045B, and 7046B Specifications

Performance Specifications

	7044B HIGH SPEED	7045B VERY HIGH SPEED	7046B 2-PEN, VERY HIGH SPEED
Type of input	Front and rear input. Floating, guarded. Polarity reversal switch on front panel.		
Input ranges	0.25, 0.5, 1, 2.5, 5, 10, 25, 50, 100, 250, 500 mV/cm. 1, 2.5, 5 V/cm. (0.5, 1, 2, 5, 10, 20, 50, 100, 200, 500 mV/in. 1, 2, 5, 10 V/in.) Continuous vernier between ranges.		
Input resistance	1 megohm constant on all ranges		
Source resistance	10 k Ω maximum on all ranges		
Accuracy	$\pm 0.2\%$ of full scale (includes linearity and deadband) at 25°C. Temp coefficient $\pm 0.01\%$ per °C		
Range Accuracy	$\pm 0.2\%$ of full scale $\pm 0.2\%$ of deflection (includes linearity and deadband) at 25°C. Temp coefficient $\pm 0.01\%$ per °C.		
Deadband	0.1% of full scale		
Common mode rejection	110 dB and 90 dB ac (exceeds 130 dB dc and 110 dB ac under normal lab environmental conditions) with 1 k Ω between HI and LO terminals. CMV applied between ground and LO, and attenuator on most sensitive range. CMR decreases 20 dB per decade step in attenuation.		
Normal mode rejection	Internal filter not available		

Dynamic Performance Specifications

Slewing speed	50 cm/s (20 in./s), min.	97 cm/s (38 in./s) typical under normal lab conditions. 76 cm/s (30 in./s) minimum.	
Acceleration peak-Y axis	2540 cm/s ² (1000 in./s ²)	7620 cm/s ² (3000 in./s ²)	6350 cm/s ² (2500 in./s ²)
-X axis	1270 cm/s ² (500 in./s ²)	5080 cm/s ² (2000 in./s ²)	3800 cm/s ² (1500 in./s ²)
Overshoot	2% of full scale maximum.	1% of full scale maximum.	

Offset Specifications

Zero offset	Zero may be placed anywhere on the writing area or electrically off scale up to one full scale from zero index.
-------------	---

Time Base Specifications

Time base	8 speeds: 0.25, 0.5, 1, 2, 5, 10, 25, 50 s/cm (0.5, 1, 2, 5, 10, 20, 50, 100 s/in.)
Time base accuracy	1.0% at 25°C. Temp coefficient at $\pm 0.1\%/C^{\circ}$

General Specifications

Power	100, 120, 220, 240 Vac +5 -10%; 48 to 440 Hz; 135 VA	100, 120, 220, 240 Vac +5 -10%; 48 to 440 Hz; 230 VA	100, 120, 220, 240 Vac +5 -10%; 48 to 440 Hz; 230 VA
Pen lift	Electric (remote via TTL level)		
Writing area	25 x 38 cm (10 x 15 in.)		
Weight	Net 13.7 kg (30 lb)		Net 16 kg (35 lb)
Size	400 H x 483 W x 165 mm D (15.8" x 19" x 6.5").		441 H x 483 W x 173 mm D (17.4" x 19" x 6.8").

7044B, 7045B Options

- 001 Time base
- 002 Event marker
- 006 Metric calibration

7046B Options

- 001 Time base
- 002 Event marker
- 007 Metric calibration
- 085 VDE certification (VDE specification DIN 57411)

Ordering Information

- 7044B High speed recorder
- 7045B Very high speed recorder
- 7046B 2-pen, very high speed recorder
- OEM discounts available

RECORDERS, PLOTTERS & PRINTERS

Compact, Wide-Range Strip Chart Recorder

Model 680

- Low-cost, high quality recording
- User-selectable speeds and spans
- Metric or English recording
- Compact design

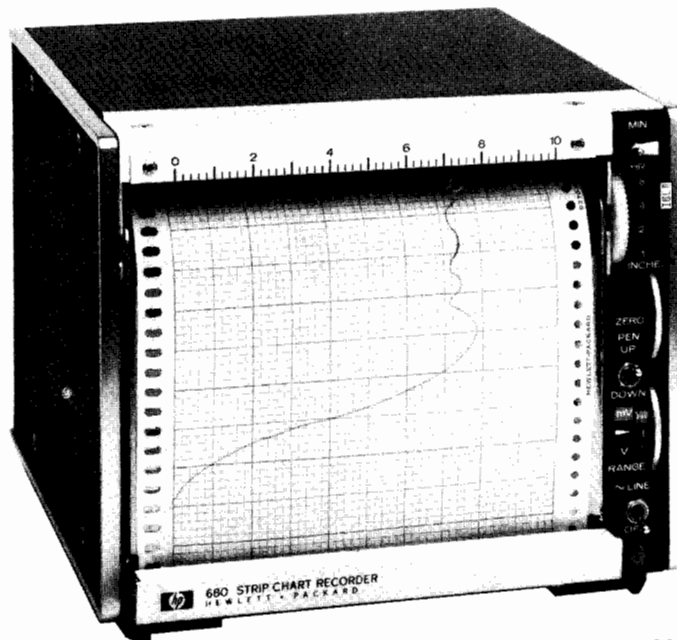

680

Model 680 Strip Chart Recorder

The compact 680 produces quality recordings on a 12 cm or 5 in. wide grid. The versatility of the 680 is demonstrated by the wide range of user-selectable speeds and spans, providing one small unit that fills many metric or English recording needs. Major areas of versatility include the following: ten selectable voltage spans from 6 mV to 120 V (5 mV to 100 V for English recording) to magnify specific data; eight selectable speeds from 2.5 cm/hr to 20 cm/min (1 in./hr to 8 in./min for English recording) to use the most compatible speed with the data input rate; and two ink writing systems to provide a steel pen for maximum durability or optional disposable fiber and capillary tips to help prevent possible clogging due to noisy data. The 680 also provides a remote electric pen lift, full-scale zero adjustment, and standard input filter to eliminate the effects of signal noise. Primary uses of the 680 are as a monitor for instrumentation with dc outputs and for digital devices using digital-to-analog converters.

680 Performance Specifications

Spans: ten calibrated spans; metric—6, 12, 60, 120, 600 mV; 1, 2, 6, 12, 60, 120 V (English—5, 10, 50, 100, 500 mV; 1, 5, 10, 50, 100 V)

Input type: floating; (40 Vdc and peak ac maximum, conforms to IEC 348) single-ended rear connector

Maximum dc common mode voltage: 500 V

Input resistance: 166 k Ω /V (200 k Ω /V, English) full scale, through 10 V span; 2 M Ω on all others

Common mode rejection: dc 100 dB on most sensitive range. Decreases 20 dB per decade step in attenuation

Accuracy: $\pm 0.2\%$ of full scale

Response time: maximum, 0.5 s full scale

Resettable: 0.1% of full scale

Chart speed: synchronous motor driver; metric—2.5, 5, 10, 20 cm/min; 2.5, 5, 10, 20 cm/hr (English—1, 2, 4, 8 in./min and in./hr). With option 008 (gear ratio 16:1 instead of 60:1) chart speeds are divided by 16.

Zero set: adjustable over full span

680 General Specifications

Writing mechanism: ink

Pen lift: electric, controlled by local switch or remote contact closure

Power: 115/230 V, 60 Hz, 22 VA

Weight: net, 5 kg (11 lb). Shipping 7.6 kg (17 lb).

Size: 165 H x 197 W x 219 mm D (6.5" x 7.8" x 8.6").

680 Options

001 Retransmitting potentiometer

002 Event marker

003 High-low limit switches

008 16/1 speed reducer (replaces 60/1)

009 Remote chart on-off

010 50 Hz operation

014 Glass door with lock

018 Disposable pen tips

026 Metric calibration

H01 Additional span: 1.2 mV metric, 1 mV English

H02 100 k Ω input resistance

Ordering Information

680 Strip chart recorder

OEM discounts available

- One-pen or two-pen recording
- Disposable pens or thermal writing
- User-selectable voltage spans
- OEM models available

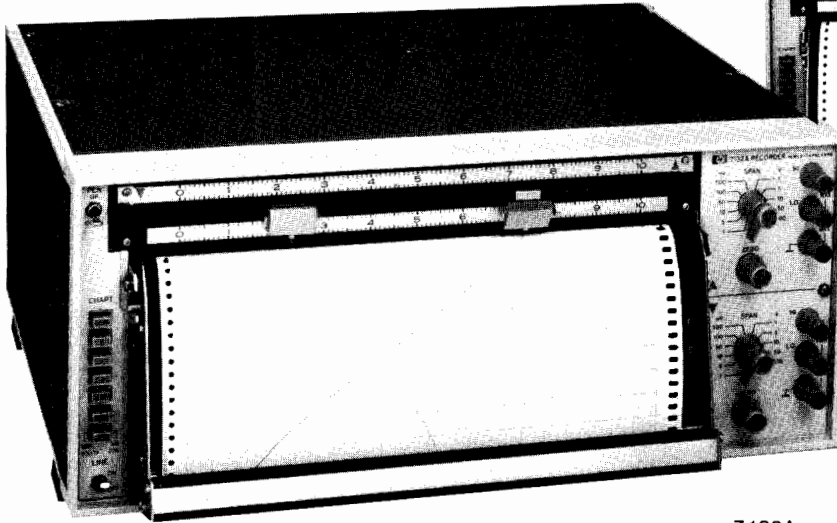

7132A

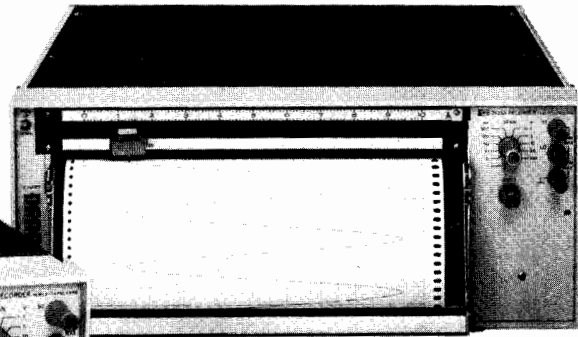

7133A

Models 7132A and 7133A Strip Chart Recorders

The two-pen 7132A and one-pen 7133A are designed with a stepper motor chart drive for metric or English recording. This drive allows the chart advance to be controlled by an external pulse input, or by front-panel pushbuttons. When controlled by an external pulse, the chart speed is changed by variation in the rate at which pulses are applied to the motor, allowing the chart advance to be synchronized to an external event. Both recorders are manufactured with a belt-driven modular servo system for quiet, reliable operation. This modular design cuts maintenance costs by reducing the time necessary for routine inspections and maintenance. In addition, both recorders ensure longer pen life by reducing the amplifier gain automatically if the pen is driven off scale.

The power of the 7132A and 7133A is demonstrated by these features: 11 selectable voltage ranges from 1 mV to 100 V in 1, 5, and 10 steps, plus front-panel control for overlapping span adjustment; 8 selectable chart speeds from 15 cm/min to 2.5 cm/hr (6 in./min through 1 in./hr), plus external impulse control; and two writing systems, disposable ink pens or optional thermal writing for unattended operation.

Other options include right-hand zero (option 014) to deflect the pen from right to left for recording positive voltage, and event markers (options 037, 038, and 537) to mark the position of important events on either margin.

Model 7130A, 7131A OEM Strip Chart Recorders

The two-pen 7130A and one-pen 7131A are 25 cm (10 in.) strip chart recorders designed primarily for the OEM market. Providing a large range of voltage span and chart speed options, these units are designed with the ruggedness, compactness, and performance required by OEM users. For a list of specifications and options, contact your HP sales representative.

7132A, 7133A Performance Specifications

Input ranges: eleven ranges from 1 mV to 100 V full scale in 1-5-10 sequence with overlapping vernier

Input type: floating (40 V dc and peak ac maximum, conforms to IEC 348), single ended, front connector

Input resistance: 1 megohm on all ranges

Maximum source resistance: 10 k Ω (to within rated response)

Normal mode rejection (at line frequency): > 40 dB

Common mode rejection: > 120 dB dc and 100 dB ac

Accuracy: $\pm 0.2\%$ of full scale (includes linearity and deadband) at 25°C. Temp coefficient $\pm 0.01\%$ per °C

Range accuracy: $\pm 0.2\%$ of full scale $\pm 0.2\%$ of deflection (includes linearity and deadband) at 25°C. Temp coefficient $\pm 0.01\%$ per °C

Deadband: 0.1% of full scale

Response time: less than 0.5 second

Overshoot: less than 2% of full scale

Chart speeds: 2.5, 5, 10, 15 cm/min, and cm/hr (1, 2, 4, 6 in./min, and in./hr)

Chart speed accuracy: $\pm 0.08\%$ plus line frequency accuracy

Zero set: provides three full scales of offset

Environmental (operating): 0 to 55°C, less than 95% relative humidity (40°C)

7132A, 7133A General Specifications

Writing mechanism: disposable ink pens (thermal writing optional)

Grid width: 25 cm (10 in.)

Chart length: 24 m (80 ft)

Pen lift: solenoid operated with remote capabilities

Power: 115/230 V $\pm 10\%$, 50 or 60 Hz, 120 VA

Size: 184 H x 432 W x 340 mm D (7.3" x 17" x 13.4")

Weight: Net, 13 kg (28 lb). Shipping, 19 kg (42 lb).

7132A, 7133A Options

001 Metric calibration

014 Right-hand zero (hard)

037 Right-hand event marker (not compatible with option 054)

038 Thermal event marker (option 054 required)

050 50 Hz line power

054 Thermal writing (for pen speed below 5 in./sec): on 7132A

on 7133A

060 60 Hz line power

537 Left-hand event marker, 7132A only (not compatible with option 054)

908 Rack mounting brackets

Ordering Information

7132A Two-pen laboratory recorder

7133A One-pen laboratory recorder

7130A Two-pen OEM recorder

7131A One-pen OEM recorder

OEM discounts available



RECORDERS, PLOTTERS & PRINTERS

Four and Eight-Channel Oscillographic Recorders

Models 7414A, 7418A & 8800 Series Signal Conditioners

- Thermal writing for low maintenance
- Z-fold paper for easy review/ storage
- Available in benchtop configuration, mobile cart, upright cabinet

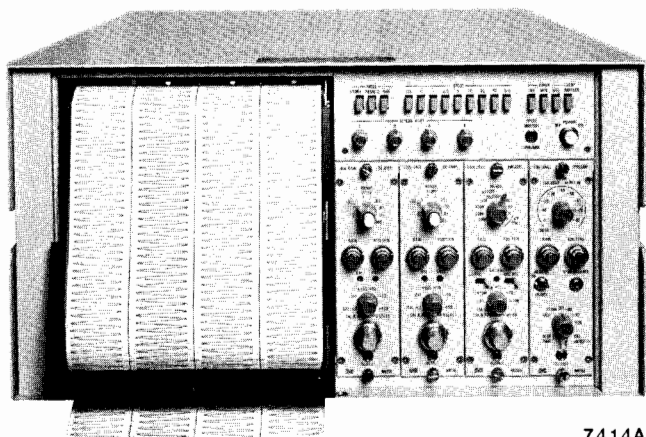

7414A

Models 7414A 4-Channel and 7418A 8-Channel Oscillographic Recorders provide permanent reproducible records of multichannel, real-time data. A complement of 8800 Series Plug-in Signal Conditioners results in a system capable of meeting many measurement requirements in a reliable, versatile manner.

Thermal writing tips feature long stylus life and rectilinear presentations. A Z-fold chart paper pack loads easily, allows for convenient data review and storage. Two markers are supplied. The timer marker can be selected for one-second or one-minute marks. The event marker can be activated remotely or by front panel pushbutton.

7414A, 7418A, 8800 Series Plug-in Specifications

7414A General Specifications

Chart speeds: 0.25, 0.5, 1.0, 2.5, 10, 25, 50, 100 mm/s. Speed regulation $\pm 1\%$. Paper weave less than 0.5 mm. Speed selected via front panel pushbuttons. Optional speeds in mm/min.

Limiting: electrical limiting keeps stylus within channel.

Markers: event (local or remote control) between ch 3 and 4. (Timer (1 min or 1 s selectable) between ch 1 and 2.)

Chart paper: four 40 mm wide channels each with 50 div; time lines every 1 mm; heat sensitive Z-fold Permapaper® with green grid lines available in packs of 500 sheets, each 30 cm (12"). (Part number 9270-0878).

Paper loading: no threading required.

Remote operation: rear panel connector provides for remote chart drive and event marker activation.

Power: 115/230 V ac $\pm 10\%$, 60 Hz, 350 VA (includes plug-ins) 50 Hz optional.

Size: 266.7 H x 482.6 W x 577.9 mm D (10½" x 19" x 22¾"). Projection: 76.2 mm (3") from rack front.

Weight: net, 50.5 kg (112 lb). Shipping, 59.5 kg (132 lb).

7418A General Specifications

Chart speeds: 0.5, 1, 2.5, 5, 10, 25, 50, 100, 200 mm/s. Speed regulation $\pm 1\%$. Paper weave less than 0.5 mm. Speed selected via front panel pushbuttons (or remote). Optional speeds in mm/min.

Chart paper: eight 40 mm wide channels each with 50 divisions; time lines every 1 mm. Heat sensitive Chemical Thermal Paper standard for all system recorders except option 050. Permapaper® for Option 050 recorders only. Chemical Thermal Paper available in packs of 400 sheets, each 30.1 cm (12") long x 40.2 cm (15.8") wide (part number 9270-0563 red grid). Permapaper available in packs of 500 sheets, each 30.1 cm (12") long x 40.2 cm (15.8") wide (part number 9270-0946 green grid).

Remote operation: rear panel connector provides for chart drive and event marker, optional extra markers. Remote connector supplies -20 V.

Power: 115/230 V ac $\pm 10\%$, 60 Hz. Recorder only 575 VA; system plug-ins 695 VA.

Size: rack: 266.7 H x 482.6 W x 577.9 mm D (10½" x 19" x 22¾"). Projection: 76.2 mm (3") from front of rack.

Weight: 50 kg (110 lb) including driver amplifiers.

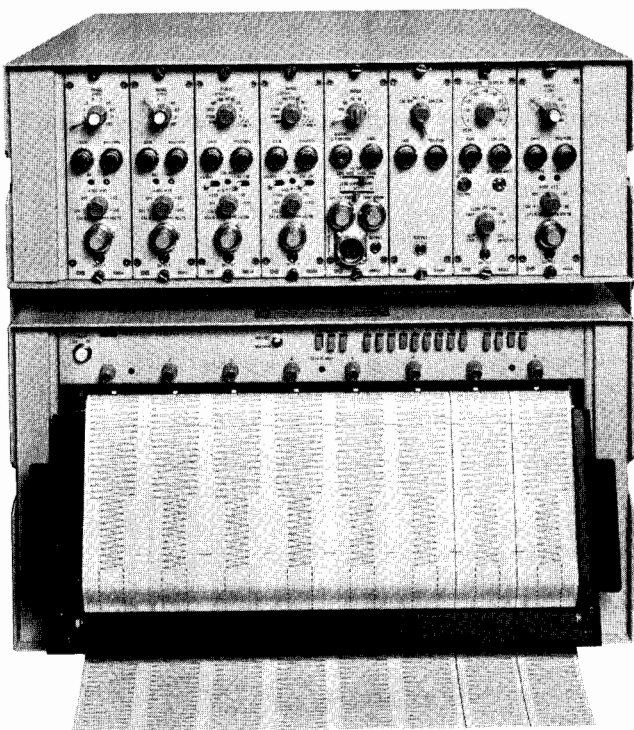

7418A with Options 030 and 003

- Plug-in versatility for 7414A/7418A

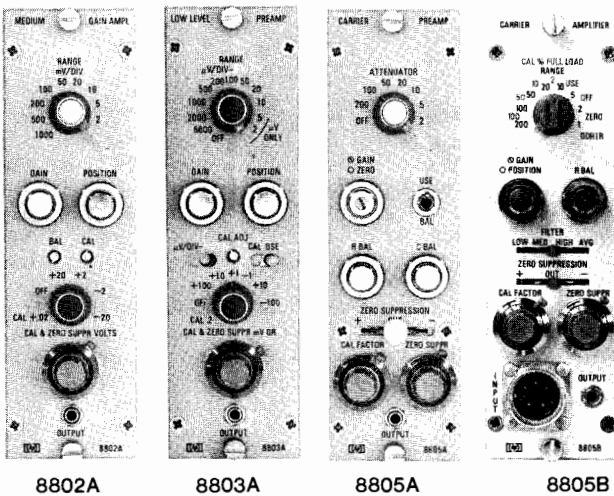

8803A High Gain DC Amp

Input ranges: 1, 2, 5, 10, 20, 50, 100, 200, 500, 1000, 2000, 5000 $\mu\text{V}/\text{div}$; 10, 20, 100, 200, 500, 1000, 2000, 5000 mV/div ; accuracy $\pm 1\%$ on 5000 $\mu\text{V}/\text{div}$ to 20 $\mu\text{V}/\text{div}$ ranges, $\pm 2\%$ on 10 $\mu\text{V}/\text{div}$ to 1 $\mu\text{V}/\text{div}$; accuracy of $\times 1000$ attenuator $\pm 1\%$.

Max sensitivity: 1 $\mu\text{V}/\text{div}$ (gain 100,000)

Max fs input: 250 V.

Input circuit and input frequency range: 1 M Ω min on μV range, independent of gain; 5 M Ω on mV range; floating and guarded.

Rise time (10 div, 10-90%, 4% overshoot): 5 ms. 6% overshoot.

Calibration (referred to input): 200 $\mu\text{V} \pm 1\%$ internal on $\mu\text{V}/\text{div}$ range; 200 $\text{mV} \pm 1\%$ internal on mV/div range.

Output frequency response (-0.5 dB at 50 div): 50 Hz.

Zero suppression: μV ranges $\pm 1, \pm 10, \pm 100 \text{ mV}$; mV ranges $\pm 1, \pm 10, \pm 100 \text{ V}$, 10-T pot sets precise values of zero suppression voltages; accuracy $\pm 1\%$ suppression range.

Output noise, max (less trace width): 1.5 mm p-p at 1 $\mu\text{V}/\text{div}$; 0.1 div, p-p min gain.

Zero drift, 20% to 40%, 103 to 127 V (less trace width): temp— μV range 1 $\Omega\text{V}/10^\circ$ referred to input, $\pm 0.26 \text{ div}/10^\circ \text{ C}$ for 0 output & $\pm 0.65 \text{ div}/10^\circ \text{ C}$ for fs output. mV range, 1 $\text{mV}/10^\circ \text{ C}$ referred to input, $\pm 0.26 \text{ div}/10^\circ \text{ C}$ for 0 output. Line voltage 0-0.07 div; fs 0.35 div.

Common mode rejection and tolerance: μV range, max source unbal of 1 k Ω ; 160 dB min at dc, 120 dB min at 60 Hz; mV range, max source unbal of 500 k Ω ; 100 dB min at dc, 60 dB min at 60 Hz dc. 300 V pk; 60 Hz. 1 $\mu\text{V}/\text{div}$, 10 V rms; 2 $\mu\text{V}/\text{div}$, 20 V rms; 5 $\mu\text{V}/\text{div}$, 50 V rms; 10 $\mu\text{V}/\text{div}$ and 10 mV/div , 100 V rms; 20 μV to 5000 $\mu\text{V}/\text{div}$ and 20 mV to 5000 mV/div , 200 V rms.

Output linearity (less trace width): 1 mV range 0.35 div, others 0.25 div after calibrating for zero error at center scale and +20 div.

8805A/B Carrier Preamp

Input ranges: X1, 2, 5, 10, 20, 50, 100, 200; accuracy $\pm 2\%$.

Max sensitivity: 10 μV rms/div (gain 10,000 rms ac to dc)

Max fs input: 100 mV rms.

Input circuit and input frequency range: input impedance—8805A approx 10 k Ω ; 8805B 1 M $\Omega \pm 10\%$; single-ended. Min load resistance across excitation 100 Ω . Max impedance in series with input (transducer output impedance) 5 k Ω . Excitation—floating source 5 V rms nominal at 2400 Hz $\pm 2\%$. Internal switch allows use with full or half bridge transducer.

Rise time (10 div, 10-90%, 4% overshoot): 5.6 ms.

Calibration (referred to input): 2% $\pm 0.02\%$ of transducer fs output. Adjust by Cal Factor control; accuracy $\pm 55 \mu\text{V}/\text{V}$ out of 10 mV/V . 8805B switchable Cal voltage to 2%, 10%, 50%, or 100% $\pm 1\%$ of fs.

Output frequency response (-0.5 dB at 50 div): 50 Hz.

Zero suppression: 0-100% of transducer full load rating, for transducers having Cal Factor up to 10 mV/V at full load, 10-T pot with calibration dial; accuracy—1 dial div $\pm 0.5\%$ of suppress range. Zero Supp Polarity switch, Separate R Bal control allows bucking of in-phase unbal to $\pm 3 \text{ mV}/\text{V}$ regardless of Cal Factor.

Output noise, max (less trace width): approx. 0.2 div, p-p.

Zero drift, 20% to 40%, 103 to 127 V (less trace width): temp—0.45 $\text{div}/10^\circ \text{ C}$; Line voltage—0.25 div.

Common mode rejection and tolerance: quadrature rejection and tolerance: $>40\text{dB}$. Tolerance error: $< \pm 2\%$ fs when quadrature voltage equal to twice in-phase signal required for center to edge deflection on chart. C Balance control permits bucking of transducer's quad unbalance of up to $\pm 5 \text{ mV}/\text{V}$. The 8805B has automatic C balance.

Output linearity (less trace width): 0.4 div after calibrating for zero error at center scale and +20 div.

8801A Low Gain DC Amp

Input ranges: 5, 10, 20, 50, 100, 200, 500, 1000, 2000, 5000 mV/div ; accuracy $\pm 1\%$.

Max sensitivity: 5 mV/div (gain 20).

Max fs input: 250V.

Input circuit & input frequency range: resist. 500 k $\Omega \pm 1\%$ each side bal to gnd; parallel with approx. 100 pF

Rise time (10 div, 10-90%, 4% overshoot): 5 ms.

Calibration (referred to input): 100 mV , $\pm 1\%$, internal.

Output frequency response (-0.5 dB at 50 div): 50 Hz.

Zero suppression: ± 10 and $\pm 100 \text{ V}$ for single-ended or diff. signals. 10-T pot sets precise values of zero suppression voltages; $\pm 50 \text{ V}$ max suppress on 5, 10, 20 mV/div ranges; max error of suppression $\pm 0.5\%$ of suppression range, and 1% of indicated suppression.

Output noise, max (less trace width): 0.2 div, p-p.

Zero drift, 20° to 40°C, 103 to 127 V (less trace width): temp—1.25 $\text{div}/10^\circ \text{ C}$, 0.5 div/hr , constant ambient. Line voltage—0.15 div.

Common mode rejection and tolerance: 48 dB min, dc to 150 Hz; $\pm 50 \text{ V}$ max on other ranges for $< 1\%$ change in differential sensitivity.

Output linearity (less trace width): 0.25 div, after calibration for zero error to center scale +20 div.

8802A Medium Gain DC Amp

Input ranges: 1, 2, 5, 10, 20, 50, 100, 200, 500, 1000 mV/div ; accuracy $\pm 1\%$.

Max sensitivity: 1 mV/div (gain 100).

Max fs input: 50 V.

Input circuit and input frequency range: resist 180 k $\Omega \pm 1\%$, each side bal to gnd, parallel with approx 100 pF.

Rise time (10 div, 10-90%, 4% overshoot): 5 ms.

Calibration (referred to input): 20 mV , $\pm 1\%$, internal.

Output frequency response (-0.5 dB at 50 div): 50 Hz.

Zero suppression: $\pm 2 \text{ V}$ and 20 V for single-ended or differential signals; 10-T pot sets precise values of zero suppression voltages; ± 12.5 max suppression on 1, 2, 5 mV/div ranges; max error of suppression $\pm 0.5\%$ of suppression range and 1% of indicated suppression.

Output noise, max (less trace width): 0.2 div, p-p.

Zero drift, 20° to 40° C, 103 to 127 V (less trace width): same as 8801A.

Common mode rejection and tolerance: 48 dB min dc to 60 Hz, 1000 mV/div range; 48 dB min. dc to 150 Hz other ranges $\pm 12.5 \text{ V}$ on 1, 2, 5 mV/div ranges; $\pm 125 \text{ V}$ on 10, 20, 50 mV/div ranges; $\pm 500 \text{ V}$ max other ranges for less than 1% change in differential sensitivity.

Output linearity (less trace width): same as 8801A.



RECORDERS, PLOTTERS & PRINTERS

Four and Eight-Channel Oscillographic Recorders

Models 7414A, 7418A & 8800 Series Signal Conditioners (cont.)

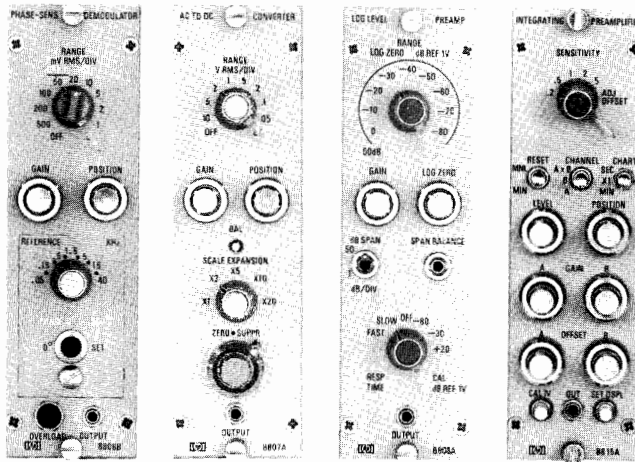

8806B Opt. 002

8807A

8808A

8815A Opt. 002

8806B Phase Sensitive Demodulator

Must be purchased with minimum of one of the four available options.

Input ranges: sig input—0.5, 1, 2.5, 10, 20, 50, 100, 200, 500 mV/div; $\pm 1\%$, 50 Hz to 10 kHz; $\pm 2\%$, 10 kHz; $\pm 3\%$, 20 kHz to 40 kHz. Reference voltage—3 to 20 rms, 20 to 133 V rms.

Max sensitivity: 0.5 mV rms/div (gain 200 rms ac to dc).

Max fs input: 25 V rms full scale.

Input circuit and input frequency range: signal input:—transformer isolated, floating point and guarded; resistance approx 1 M Ω . Reference input: differential, transformer coupled; resistance approx 500 k Ω each side to ground, may be used single ended. 50 Hz to 40 kHz in 6 bands with variable frequency plug-in (Opt. 002); 60 Hz (Opt. 003), 400 Hz (Opt. 004) and 5 kHz (Opt. 005) fixed frequency phase shifter plug-in; special order phase shifter plug-ins 50 Hz to 40 kHz. Note: must order with frequency plug-in.

Rise time (10 div, 10-90%, 4% overshoot): 5 ms (5 kHz ref).

Calibration (referred to input): 1 V rms internal at carrier reference frequency; $\pm 1\%$ 50 Hz to 10 kHz; $\pm 2\%$ 10 kHz to 20 kHz; $\pm 3\%$ 20 kHz to 40 kHz.

Zero suppression: none. Phase shifter plug-ins allow control of reference phase over 360°. Fixed frequency: 0° to 90° dial; 2° graduations; any of 4 quadrants by panel switches; dial accuracy within $\pm 3^\circ$. Variable frequency: adjust thru 360°.

Output noise, max (less trace width): 7 μ V x sq root of frequency response, referred to input.

Zero drift, 20° to 40°C, 103 to 127 V (less trace width): temp: 0.5 div/10°C; Line voltage: 0.25 div.

Common mode rejection and tolerance: CM: >40 dB up to 10 kHz 500 V rms, max. Quadrature tolerance: equal to amplitude of a fs, in-phase signal.

Output linearity (less trace width): 0.4 div after calibrating for zero error at center scale and +20 div.

8807A AC to DC Converter

Input ranges: 0.02, 0.05, 0.1, 0.2, 0.5, 1, 2, 5, 10 V rms/div, $\pm 2\%$ (midband). Scale expansion: X1, 2, 5, 10, 20, $\pm 2\%$.

Max sensitivity: 1 mV rms/div (gain 100 rms ac to dc). 20 mV rms/div with X1 scale expansion.

Max fs input: 500 V rms.

Input circuit and input frequency range: approx 1 M Ω resistive in parallel with 10 pF and stray cable capacitance; floating and guarded. Standard model: 330 Hz to 100 kHz; Opt 001: 50 Hz to 100 kHz.

Rise time (10 div, 10-90%, 4% overshoot): 11.2 ms. Opt 001: 70 ms, approx 10% overshoot.

Calibration (referred to input): 1 V internal $\pm 1\%$; approx 500 Hz.

Output frequency response (-0.5 dB at 50 div): 54 Hz (3 dB at 10 div). Opt 001—9Hz.

Zero suppression: up to 100% of fs on any range can be suppressed;

10-T pot with calibrating dial. Scale expansion: 5, 10, 20, or 50% of fs can be expanded to cover full chart.

Output noise, max (less trace width): baseline offset/noise: 2 mV rms referred to input +0.025 div \times scale expansion

Zero drift, 20° to 40°C, 103 to 127 V (less trace width): temp 0.03 div/10°C \times scale expansion +0.35 div/10°C; at constant ambient 0.005 div/hr \times scale expansion. Line voltage 0.005 div \times scale expansion +0.1 div.

Common mode rejection and tolerance: 60 dB min at 60 Hz; 40 dB min at 400 Hz with up to 10 K source unbalance; ± 500 V pk.

Output linearity (less trace width): 0.55 div +0.05 div \times scale expansion, 330 Hz to 5 kHz; Opt 001: 60 Hz to 5 kHz, after calibration for zero error at lower and upper ends of printed coordinates.

8808A Log Level Preamp

Input ranges: 50 dB span: bottom scale -80, -70, -60, -50, -40, -20, -10, and 0 dB below 1 V (i.e. 100 μ V, 320 μ V, 1, 3.2, 10, 32, 100, 320 mV and 1V). 100 dB span bottom scale -80, -70, -60, and -50 dB below 1 V.

Max sensitivity: 100 μ V rms sine wave corresponds to bottom scale output, -80 dB below 1 V.

Max fs input: 320 V rms.

Input circuit and input frequency range: single ended, resistance 1 M Ω min. 5 Hz to 100 kHz for <3 dB down from the midband level on "Slow" response range; 500 Hz to 100 kHz on "Fast" response range.

Rise time (10 div, 10-90%, 4% overshoot): fast: 20.5 rms (875 dB/s) Slow: 2 s (9 dB/s).

Calibration (referred to input): internal from oscillator at approx 500 Hz. -80, -30, and ± 20 dBV = dB ref. to 1 V (100 μ V, 32 mV and 10 V) -80 +20 dBV internally adjustable: -30 dBV accuracy ± 0.25 dB (at 115 V line at 25°C).

Output noise, max (less trace width): 50 dB range: 0.8 div, p-p, 100 dB range: 0.4 div, p-p (max noise at bottom of recording chart).

Output linearity (less trace width): departure from log characteristics 50 dB: 1.25 div, 100 dB: 1 div, after calibrating for zero error at lower and upper ends of printed coordinates.

8809A Signal Coupler

Input ranges: continuously adjustable from 20 to 50 mV/div.

Max sensitivity: 30 mV/div (gain 3.33).

Max fs input: 0 to +2.5 V or 0 to -2.5 V.

Input circuit and input frequency range: switch selected: 1500 Ω $\pm 2\%$ or 100 k Ω min, incremental; single ended.

Rise time (10 div, 10-90%, 4% overshoot): 5 ms.

Calibration (referred to input): 600 mV $\pm 2\%$, internal.

Output frequency response (-0.5 dB at 50 div): 50 Hz.

Output noise, max (less trace width): 0.1 div, p-p.

Zero drift, 20° to 40°C, 103 to 127 V (less trace width): temp: 0.4 div/10°C at 30 mV sensitivity. Line voltage: 0.3 div.

Common mode rejection and tolerance: 50,000: 1 at dc.

Output linearity (less trace width): 0.4 div after calibrating for zero error at center scale and +20 div.

8815A Opt 002 General Purpose Integrator

Sensitivity ranges: 0.2, 0.5, 1, 2, 5. Sensitivity setting of 1 results in the following integrator outputs:

Seconds integrator: 1 volt per volt-second input (0.1 volt-seconds per recorded division, or 5 volt-seconds full scale).

Minute integrator: 1 volt per 60 volt-seconds input (6 volt-seconds per recorded division or 300 volt-seconds full scale). For other sensitivity settings, divide the above volt-second values by the sensitivity switch setting.

Offset control: ± 2.8 volts referred to input. Can be used with switch-selectable rectifier to rectify (or ignore) portions of roughly sinusoidal inputs.

Drift: seconds integrator, ± 5 mV/s, referred to output; minute integrator, ± 15 mV/min., referred to output.

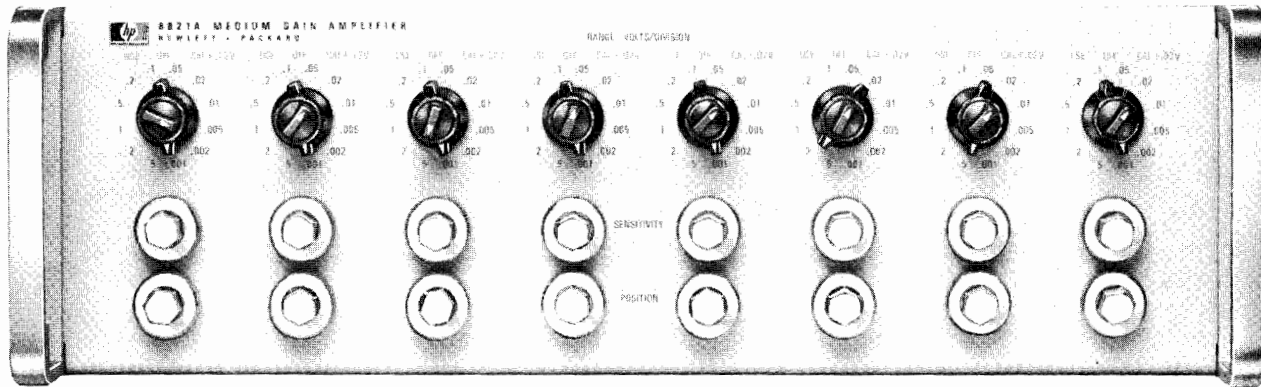

8821A

8820A Eight Channel Bank Amplifier

Max sensitivity: 0.05 V/div (Amplifier Gain 2).

Max fs input: 250 V (edge to edge).

Input ranges (attenuation): 0.05, 0.1, 0.2, 0.5, 1, 2, 5 V/div. Attenuator accuracy $\pm 2\%$.

Input circuit: single ended, 1 M Ω min.

Frequency response: dc to < 0.5 dB down at 50 Hz (50 div. p-p); dc to < 3 dB down at 100 Hz (10 div. p-p).

Rise time (10 div, 10-90%, 4% overshoot): < 6 ms.

Output linearity (less trace width): linear within ± 0.25 div. after setting mechanical zero of stylus to within ± 1 div of chart center and calibrating for zero error at center scale and ± 20 div.

Drift, 20° -40°, 115 V $\pm 10\%$, 60 Hz (less trace width): temp: $< 0.55\%/10^\circ\text{C}$; Line voltage: $< \pm 0.2$ div.

Calibration: 1 V \pm % calibration voltage for all channels.

Temp rating: operating: 0°C to +55°C; storage: -40°C to 75°C.

8821A Eight Channel Bank Amplifier

Max sensitivity: 0.001 V/div (Amplifier Gain 100).

Max fs input: 250 V (edge to edge).

Input ranges (attenuation): 0.001, 0.002, 0.005, 0.010, 0.020, 0.050, 0.1, 0.2, 0.5, 1, 2, 5 V/div. Attenuator accuracy (dc) $\frac{1}{2}\%$ on 0.001 to 0.050 V/div ranges; 1% on 0.1 to 5 v/div ranges.

Input circuit: balanced, floating and guarded, 9 M Ω constant for all gain settings (0.001 to 0.050 V/div); 4.5 m Ω each side to ground (0.1 to 5 V/div).

Common mode rejection: 100 dB at 60 Hz, 0.001 V/div sensitivity, 1 k Ω source unbalance decreases to 66 dB at 0.05 V/div, 66 dB at 60 Hz, 0.01 to 5 V/div sensitivity. 1 k Ω source unbalance.

Common mode tolerance: ± 20 V on 0.001 to 0.05 V/div ranges (6 most sensitive); ± 250 V on 0.1 to 5 V/div ranges (6 least sensitive).

Frequency response: dc to < 0.5 dB down at 50 Hz (50 div, p-p). dc to < 3 dB down at 200 Hz (10 div p-p).

Rise time (10 div, 10-90%, 4% overshoot): < 6 ms.

Output linearity (less trace width): same as 8820A.

Drift, 20° to 40°C, 115 V $\pm 10\%$, 60 Hz (less trace width): same as 8820A.

Calibration: +0.02 V $\pm 1\%$ on 6 most sensitive ranges. Simulates +2 V $\pm 2\%$ at input on 6 least sensitive ranges.

Temperature rating: same as 8820A.

Ordering Information

7414A 4-channel Oscillographic Recorder

Opt 001: rack mount kit with slides and mounting hardware; delete case.

Opt 008: 50 Hz operation

Opt 015: extra Event Marker, between channels 2 & 3

Opt 025: 60:1 speed reduction (50 Hz), requires Opt 008

Opt 026: 60:1 speed reduction (60 Hz)

Opt 054: installed in mobile cart. Rack space: 53 cm (21 in). Cart height: 102 cm (40.75 in). Includes paper takeup drawer.

7418A 6 to 8-channel Oscillographic Recorder

Opt 001: 6 channel Hot-tip Thermal Recorder only; includes takeup tray. Plug-in preamplifiers require Opt 030 Power Supply; for 8-channel Bank Amplifiers (Power Supply included) select Opt 031 or 032

Opt 002: rack mount kit

Opt 003: bench-top configuration

Opt 004: 160 cm (63 in) rack space cabinet. Cabinet height: 177 cm (72.5 in). Includes paper takeup drawer.

Opt 006: Portable Cart with 71 cm (28 in) rack space, includes Opt. 002. Cart height: 126 cm (50.5 in).

Opt 008: 50 Hz operation

Opt 009: 230 V ac operation

Opt 014: extra Event Marker between channels 4 & 5

Opt 015: extra Event Marker between channels 5 & 6

Opt 025: 60:1 speed reduction (50 Hz), requires Opt 008

Opt 026: 60:1 speed reduction (60 Hz)

Opt 030: 8848A plug-in Preamplifier Power Supply, required for operation of 8800 preamplifiers

Opt 031: 8820A 8-channel Low Gain Bank Preamplifier

Opt 032: 8821A 8-channel Medium Gain Bank Preamplifier

Opt 035: rack mount kit for HP 29400 series cabinet

Opt 050: recorder equipped for permapaper operation only

8801A Low Gain Preamplifier

8802A Medium Gain Preamplifier

8803A High Gain Preamplifier

8805A Carrier Preamplifier

Opt 002: Harmonic Filter Kit, required when 267, 268, 270, or 1280B, C transducers are used

8805B Opt 012 Carrier Preamplifier without Harmonic Filter

8806B Phase Sensitive Demodulator Preamplifier. Requires one of following plug-ins:

Opt 002: Variable Frequency Phase Shifter plug-in, 50 Hz to 40 kHz

Opt 003: 60 Hz Phase Shifter plug-in

Opt 004: 400 Hz Phase Shifter plug-in

Opt 005: 5 kHz Phase Shifter plug-in

8807A AC/DC Converter Preamplifier

Opt 001: 50 Hz to 100 kHz Signal Filter

Opt 002: DC Plug-in

8808A Logarithmic Preamplifier

8809A Signal Coupler Preamplifier

8815A Opt 002 General Purpose Integrator

Opt 003: Sample and hold (for digital display readouts)

8820A Low Gain Bank Preamplifier (8-channel)

8821A Medium Gain Bank Preamplifier (8-channel)

RECORDERS, PLOTTERS & PRINTERS

Instrumentation Tape Recorders

A Review

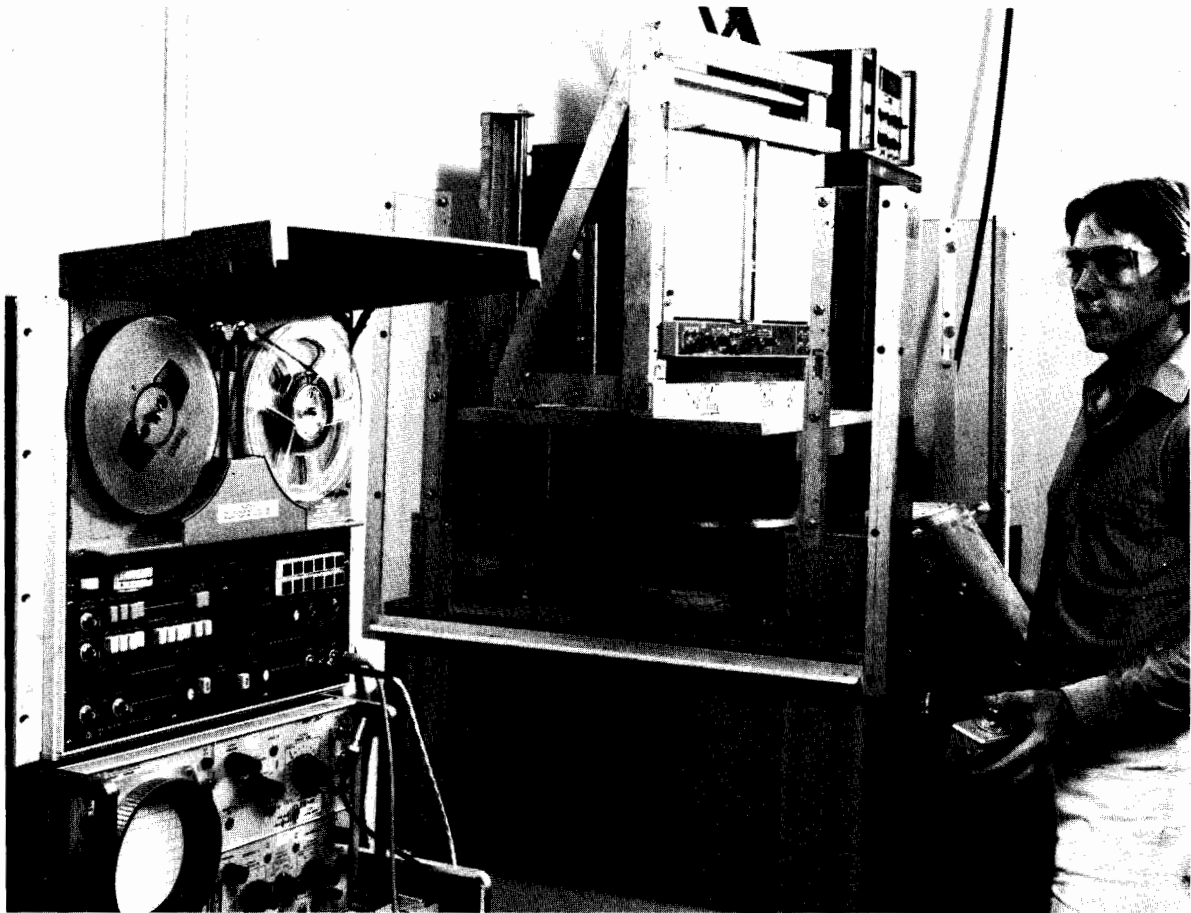

Introduction

Instrumentation tape recorders (ITR's) are used to record, store, and reproduce test data for many and varied applications. The main reasons for using ITRs are economy, accurate data recording and reproduction, and long-term data storage. ITRs manufactured by Hewlett-Packard are 4 or 8-channel recorders using 1/4-inch tape. They are designed specifically for applications under 64 kHz. ITR recording provides nondestructive reproduction so data can be reproduced repeatedly without degrading the quality, and time-base can be contracted or expanded. Data is contracted by using faster tape speeds to reproduce slow-speed data or expanded by doing the reverse to produce, for example, lower frequency data for use on a graphics recorder.

ITR Characteristics

Direct record/reproduce electronics: direct electronics accept frequencies above 100 Hz (approximate) and record the amplitude of the input signal on the tape as a proportional magnetic flux intensity. Because direct electronics require a "linear" relationship, changing tape type generally necessitates the re-equalization of each direct channel. Direct electronics also require that each recorded tape be degaussed (erased) fully before being reused.

FM record/reproduce electronics: FM electronics accept very low frequencies, including dc. In FM, the amplitude of the input signal is recorded as a frequency deviation from a "center" frequency, the maximum input amplitude being recorded as a 40% deviation. Because amplitude is converted to a frequency, FM tends to be insensitive to tape drop-outs, but sensitive to speed irregularities such as flutter. With FM, tape types can be changed without re-equalizing the channel. Since FM records to saturation, tape can be reused without degaussing with only a small (10 to 15 dB) loss in signal-to-noise ratio.

Common frequency range: FM and direct have a common segment of the frequency range in which either type of electronics can function. On Hewlett-Packard's ITRs this range is approximately 100 Hz to 5 kHz. The advantages of using direct electronics in this range are high frequency response at slow tape speeds and a general insensitivity to flutter. The advantages of FM are dc response and a general insensitivity to tape drop-outs.

Tape speed control: the tape speed is usually controlled by a phase-lock servo system in one of two ways. The more common method uses the servo system to control the

rotational speed of the tape capstan, employing a tachometer mounted on the capstan's shaft to monitor the speed. With this method, tape speed control is limited to approximately $\pm 0.2\%$, because of capstan irregularities, tape slippage, and tape stretching. The less common but more precise method uses a frequency reference placed on one track during recording as the speed reference for the phase-lock servo during reproduce. Tape servo generates a reproduce speed that is virtually identical to the record speed; the time difference between events in record and reproduce is indicated by the time base error specification (which assumes continuous phase-lock operation). The time base error figure represents a short-term specification, because drop-outs, etc., may cause momentary loss of phase lock.

Flutter: this is a short-term tape speed variation. It produces time base perturbations in direct electronics and noise in FM.

Signal-to-noise ratio: this is the ratio of maximum to minimum recordable amplitude expressed as a voltage ratio in dB. Basically, it represents the usable dynamic range.

Tape selection: it is recommended that instrumentation tape such as Ampex 797 always be used. Use of other quality tape may adversely affect head wear, signal-to-noise ratio, etc.

RECORDERS, PLOTTERS & PRINTERS

Instrumentation Tape Recorders and Degausser

Models 3964A, 3968A, and 13064A Degausser



- Continuing savings by recording on 1/4-inch tape
- Choice of 4 or 8-channel recorders
- Selection of FM or direct electronics

- Six tape speeds, including 15/32 ips
- Remote control (TTL or optional HP-IB)
- Switch selection of tach or tape servo



3968A



3964A

Models 3964A and 3968A ITR's, 13064A Degausser

The 4-channel 3964A and 8-channel 3968A are quality instrumentation tape recorders (ITRs) that provide cost-saving operation by using 1/4-inch tape for a wide variety of recordings. Medical versions of the 3964A and 3968A (Options 009 and 010) are available. These versions include a UL 544 medical listing making them useful in hospitals, medical offices, and research facilities.

The 13064A bulk tape degausser erases a complete roll of tape cleanly in seconds. A thoroughly clean tape is necessary to obtain maximum signal-to-noise ratio.

Both the 3964A and the 3968A are precision-built ITRs with features that cut costs, enhance the usefulness of the units, and simplify recording tasks in laboratory, medical, production, and field use.

3964A, 3968A Features

Cost-saving 1/4-inch tape: provides continuing savings for the life of the recorder. By using 1/4-inch tape, rather than 1/2-inch tape, users can save over 50 percent on tape costs.

AC/DC calibrator: provides an internal voltage source that simplifies the set up of input and output levels for each data channel. Six voltages, ac or \pm dc, can be pushbutton selected, applied, and monitored to check out each channel. In addition, there is an external connector to allow the use of scopes or other monitoring devices.

Tach or tape servo control: tach-servo and tape-servo systems are switch selectable.

Flutter compensation: improves the signal-to-noise ratio in FM by up to 12 dB in a vibrating environment. When switched on, flutter-generated noise introduced during record and reproduce is subtracted from all FM data channels during reproduce to improve performance. One FM channel is used for flutter compensation; this same channel can also be used for tape servo control, saving a data channel for recording when both flutter compensation and tape servo are required.

Voice capability: provides voice annotation capability on the fourth channel of the 3964A or the eighth channel of the 3968A, using the press-to-talk microphone. The voice channel accepts data only, voice only, or data with a voice interrupt. Microphone, speaker, and head-phone jack are provided with both recorders.

FM electronics-to-electronics (e-e) mode: transfers the input signal automatically to output, bypassing the record/reproduce heads. This occurs when tape is below record/reproduce speed or in Fast Forward, Rewind, or Stop mode. E-E allows the unit to be set and calibrated without using tape.

Instrumentation Tape Recorder Notes

These technical application notes are available, at no charge, from your Hewlett-Packard sales office:

Topic	Application Note No.	Part Number
Dropouts	213-1	5952-2841
Crosstalk	213-2	5952-2844
Interchannel Time	213-3	5952-2848
Displacement Error		
Magnetic Tape Recording Handbook	89	5952-2820

3964A, 3968A Transport Specifications

Tape width: 1/4 inch (6.3 mm)

Reel size: standard 7-inch (18 cm) plastic reel, totally enclosed by reel cover

Heads

3964A: One 4-track record and one 4-track reproduce

3968A: One 8-track record and one 8-track reproduce

Tape Speed* (ips)	15	7 1/2	3 3/4	1 7/8	1 5/16	1 5/32
Flutter (% p-p)	0.35	0.35	0.40	0.50	0.70	1.5
Time base error (μ s)*	± 4	± 5	± 7.5	± 15	± 25	± 50
Start time (s) (typical)	3	1.5	0.9	0.5	0.5	0.5
Tape speed accuracy (s)	0.2	0.2	0.2	0.2	0.2	0.2

*Tape servo operation

Tape motion controls: pushbutton selectable Forward Record, Reverse Record, Forward Play, Reverse Play, Fast Forward, Fast Rewind, and Stop

EOT sensing: tape drive stops automatically at the end of tape (EOT)

Reel revolution counter: 4-digit counter with pushbutton reset

RECORDERS, PLOTTERS & PRINTERS

Instrumentation Tape Recorders & Degausser

Models 3964A, 3968A, 13064A Degausser (cont.)

FM Record/Reproduce Specifications¹

Tape Speed (ips)	Passband ² (Hz)	Signal-to-noise ³ Ratio	
		3964A	3968A
15	dc-5000	48	46
7 1/2	dc-2500	48	46
3 3/4	dc-1250	48	46
1 7/8	dc-625	46	46
1 5/16	dc-312	44	44
1 5/32	dc-156	40	40

- Based on use of Ampex 797 tape or equivalent
- Frequency response over passband is ± 1.0 dB referenced to 10% of upper band edge frequency
- Signal measured with carrier deviation $\pm 40\%$ of upper passband without flutter compensation. Output filters of reproduce amplifiers selected for constant amplitude response. May also be selected for linear phase (transient) response

Flutter compensation: can improve signal-to-noise by up to 4 dB under static conditions and as much as 12 dB under conditions of vibration. Selected by rear panel switch.

Distortion: total harmonic distortion $< 1.2\%$ @ 15 to 1 1/2 ips, $< 2\%$ @ 1 5/16 to 1 5/32 ips.

Linearity: $\pm 1.0\%$ of peak-to-peak output for best straight line through zero at $\pm 40\%$ deviation

DC drift: $\pm 0.1\%$ (max) of full scale output per $^{\circ}\text{C}$

Input level: 1 V to 30 V (peak-to-peak); continuously adjustable

Input impedance: 100 k Ω nominal, shunted by < 100 pF single-ended

Output level: 1 to 5 V (peak-to-peak); continuously adjustable

Load impedance: minimum load impedance 660 Ω

Direct Record/Reproduce Specifications¹

Tape Speed (ips)	Passband (± 3 dB) ²		S/N Ratio (dB) ³	
	3964A	3968A	3964A	3968A
15	70-64000 HZ	500-64000 Hz	38	36
7 1/2	50-32000 Hz	250-32000 Hz	38	36
3 3/4	50-16000 Hz	100-16000 Hz	38	36
1 7/8	50-8000 Hz	100-8000 Hz	38	36
1 5/16	50-4000 Hz	100-4000 Hz	38	35
1 5/32	50-2010 Hz	100-2000 Hz	37	35

- Based on the use of Ampex 797 tape or equivalent
- Reference to 10% of upper band edge
- Referenced to a 500 Hz sine wave with a maximum of 1% third harmonic distortion when reproduced at 3 3/4 ips

Input level: 1 V to 30 V (p-p); continuously adjustable

Input impedance: 100 k Ω nominal, single-ended

Output level: 0.5 to 5 V (p-p); continuously adjustable

Load impedance: minimum load impedance 600 Ω

Calibrator: internal signal source, peak ac and \pm dc levels of 0, 1.0, 1.414, 2.5, 5.0, and 10.0 volts $\pm 2\%$

Meter modes: peak ac or dc, input or output

3964A, 3968A General Specifications

Size

3964A: 400 H x 427 W x 256 mm D (15.7" x 16.8" x 10.1").

3968A: 445 H x 427 W x 256 mm D (17.5" x 16.8" x 10.1").

Weight: 3964A: 29.5 kg (65 lb). 3968A: 31.3 kg (69 lb)

Power requirements: 100, 120, 220, or 240 V, $+5\%$, -10% , 48-66 Hz; 110 W average

Temperature: storage, -40°C to 75°C ; operating, 0°C to 55°C ; tape limit, 10°C to 40°C

Altitude: storage, 15240 m (50000 ft); operating, 4500 m (15000 ft)

Humidity: the system, excluding tape limitations, will operate from 10% to 95% RH (25°C to 40°C), non-condensing

Shock: 30 g maximum (11 ms) non-operating

Mounting: rack mounting kit for equipment racks, 19-inch



13064A

13064A Tape Degausser Specifications

Tape size: 1/4-inch (6.33 mm) tape on reels up to 10 1/2 inch (266 mm) in diameter

Erase: 60 dB minimum

Duty cycle: one minute ON - three minutes OFF

Size: 67 H x 133 W x 171 mm D (2.6" x 5.25" x 6.75").

Weight: approximately 4.3 kg (9.5 lb)

Power requirements: 115 V ac $\pm 10\%$, 50-60 Hz (Opt 001); 230 V ac $\pm 10\%$, 50-60 Hz (Opt 002)

3964A, 3968A Options

Record/Reproduce Channel Data Card Options

Option provides one data card. Specify one option for each channel, up to 4 for 3964A, up to 8 for 3968A.

001 FM data card, standard

030 FM data card, medical (must order Opt 009 or 010)

002 Direct data card, standard

031 Direct data card, medical (must order Opt 009 or 010)

Medical ITR Options

009 Medical version with white paint

010 Medical version with standard paint

Other Options

Specify no more than one of each option per mainframe

003 Rear panel with BNC input/output connectors for each channel.

3964A

3968A

004 Locking knob set (screwdriver adjustable)

005 Metric speed annotation on pushbuttons

007 HP-IB remote control of speeds and mode

024 Loop adapter (accommodates 5 to 30-ft loop)

026 Slides for 19 in. racks

027 Slides for HP cabinets

041 IRIG servo reference frequency

070 Overlap. For two units. Provides automatic play/record commands for second recorder when first unit tape is low

Ordering Information

3964A 4-channel instrumentation tape recorder

3968A 8-channel instrumentation tape recorder

13064A Tape degausser (specify Option 001 for 115 V ac or 002 for 230 V ac, N/C for options)

13107A Transit case for 3964A

13106A Transit case for 3968A

RECORDERS, PLOTTERS & PRINTERS

Alphanumeric, 20 Column Thermal Printer

Model 5150A

269



- Silent operation
- Optional scanner and clock
- Alphanumeric

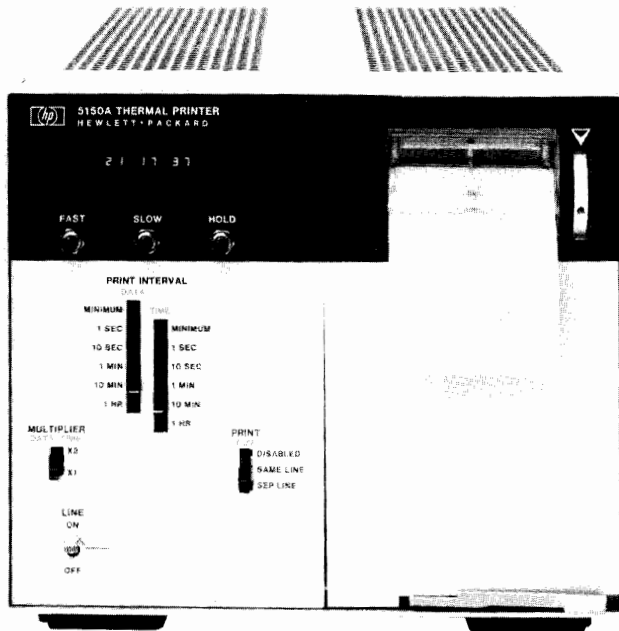

DESIGNED FOR
HP-IB
SYSTEMS

5150A Opt 004

General

The 5150A Thermal Printer is a versatile instrumentation printer designed to accept and record up to 20 columns of data from most HP digital instruments. Because it uses a thermal printing technique, it is extraordinarily quiet while in operation. Two input interfaces are available (one must be specified with the order) to allow data input from the HP Interface Bus (use Option 001) or from BCD-coded sources (use Option 002). Other options which add to the flexibility of this printer are the Option 003 Scanner, which can sequentially address and interrogate up to 13 instruments on the HP-IB, and the Option 004 Clock, which can be used with either the HP-IB or BCD Interfaces.

Opt 001 HP-IB Interface

With Option 001 installed, the printer can accept up to 20 ASCII characters per line via the HP-IB. Inputs are interpreted according to the 64 member upper-case ASCII character set. With this interface, the printer can also serve as an "addressable listener" in a controller-based HP-IB system. HP-IB cable not supplied.

Opt 002 BCD Interface

With Option 002 installed, the printer will accept 10 columns of TTL-level BCD data. Two Options 002's may be installed for 20-column print-out from one or two sources. The standard 16-member character set consists of 0 through 9, +, -, V, A, R, and [blank]. Special characters set which draw from the 64-character upper-case ASCII set may also be specified.

Opt 003 Scanner

With both Options 001 and 003 installed, the printers can log data from up to 13 instruments on the HP-IB. Operation is asynchronous; that is, the printer will address the lowest address instrument, wait for data, print, then go to the next instrument.

Opt 004 Clock

Used with either the HP-IB Interface or BCD Interface, this option gives the printer two additional capabilities: it can control the elapsed time between successive data printouts, and it can print the time of day immediately following each data printout. When used with the Option 003 Scanner, the clock controls the elapsed time between the initiation of successive scans.

Specifications

Character printer: 5 × 7 dot matrix.

Printing rate: 3 lines per second.

Line spacing: approximately 2.5 lines per cm. (6 lines per inch).

Paper advance mechanism: direct drive, stepping motor.

Paper: thermal sensitive, in rolls (one roll supplied).

Operating environment: 0°C to 50°C temperature; 95% relative humidity.

Power: 100, 120, 220, or 240 volts, 48 to 440 Hz (50 or 60 Hz only for Opt 004), 100 VA.

Dimensions: half-rack module, 178 mm H x 216 mm W x 356 mm D (7" x 8½" x 14¼").

Weight: approx. 7 kg (16 lb) (5150A +1 option).

HP-IB Interface (Opt 001)

Columns: 20.

Printed character set: 64 ASCII characters (columns 2, 3, 4, and 5 of ANSI X3.4-1968, except "j" in column 5, row 14).

Input logic levels: TTL (low <0.4 V, high >2.5 V).

Data format: byte-serial with storage, compatible with HP-IB.

Inhibit (output): holds NRFD line of HP Interface Bus low following receipt of either CR or LF (selectable) until print is completed. This interval is approx. 250 ms minimum, or the duration of Option 004 Clock data print interval with clock in Hold mode.

BCD Interface (Opt 002)

Columns: 10 (20 columns with two Options 002's installed).

Character set: 0 through 9, +, -, V, A, R, and [blank].

Input logic levels: TTL (low <0.4 V, high >2.5 V).

Data format: parallel BCD (8421); switch selects + or - true logic.

Print command: pos. or neg. TTL transition; 2 kΩ input impedance.

Inhibit (output): + or -, same levels as above; remains at true level until print is completed (approx. 250 ms minimum) or during Option 004 Clock data print interval with clock in Hold mode.

Scanner (Opt 003)

Instruments scanned: 1 to 13.

Cycle time of scan: limited by the slowest of (a) response of instruments scanned, (b) 3 samples per second, or (c) Data Print Interval setting on Option 004 Clock.

Compatibility: HP Interface Bus (utilizes ASCII code).

Identifier: labels data line of each instrument with letters A-M.

Protect feature: bypasses non-responding instrument after 3 sec.

Clock (Opt 004)

Data print interval: selectable by front panel switches: minimum, 1 s, 2 s, 10 s, 20 s, 1 min, 2 min, 10 min, 20 min, 1 hr, 2 hrs. Print interval will be that of input device if it is slower than the selected interval.

Time print interval: selectable by front panel switch, same intervals as above (intervals shorter than data interval prevented).

Time print format: selectable by front panel switch: disabled, same as data, or separate line from data.

Display: six-digit, seven-segment LED display of hours, minutes, seconds (00:00:00 to 23:59:59); settable via front panel switches.

Time base: line frequency (50 or 60 Hz, selectable by jumper).

Operating Supplies/Accessories

9281-0401 6-Roll box of paper, 76 meters (250 feet) each

10533A BCD Interface Cable for 5300A

10833A Interface Bus Cable, 1 meter

10833B Interface Bus Cable, 2 meters

10833C Interface Bus Cable, 4 meters

10833D Interface Bus Cable, .5 meter

Options

001: HP-IB Interface

002: BCD Interface

003: Scanner

004: Clock

005: BCD Interface Cable (562A-16C)

910: Extra manual

5150A Thermal Printer

Hewlett-Packard offers frequency standards and clocks which provide accurate frequency, time interval and timekeeping capabilities. Further, Hewlett-Packard standards provide means for comparing these quantities against national standards such as the National Bureau of Standards (NBS) and the U.S. Naval Observatory. Units of frequency or time cannot be kept in a vault for ready reference. They must be generated for each use, hence be regularly compared against recognized primary standards.

Frequency standards and clock systems manufactured by Hewlett-Packard are used for control and calibration at observatories, national centers for measurement standards, physical research laboratories, missile and satellite tracking stations, communication systems, radio navigation systems, manufacturing plants and radio monitoring and transmitting stations.

Types of Frequency Standards

At the present time, three types of frequency standards are in common use. These are:

1. The cesium atomic beam controlled oscillator.
2. The rubidium gas cell controlled oscillator, and
3. The quartz crystal oscillator.

Hewlett-Packard manufactures all three types of frequency standards. Of these three standards, the first is a primary frequency standard and the last two are secondary frequency standards. The distinction between a primary standard and a secondary standard is that the primary standard does not require any other reference for calibration; whereas the secondary standard requires calibrations both during manufacturing and at intervals during use depending on the accuracy desired.

Cesium Beam Frequency Standard

Cesium beam standards are in use wherever the goal is a very high accuracy primary frequency standard. In fact, the NBS frequency standard itself is of the cesium beam type. The cesium beam standard is an atomic resonance device which provides access to one of nature's invariant frequencies in accord with the principles of quantum mechanics. The cesium standard is a true primary standard and requires no other reference for calibration.

Rubidium Frequency Standard

Rubidium frequency standards feature a high order of both short-term and long-term frequency stability. These are both important in certain fields such as deep-space communications, satellite ranging, and doppler radar.

Rubidium standards are similar to cesium beam standards in that an atomic resonant element prevents drift of a quartz oscillator through a frequency lock-loop. Yet the rubidium gas cell is dependent upon gas mixture and gas pressure in the cell. It must be calibrated and then it is subject to a small degree of drift. The drift is typically 100 times less than the best quartz crystal standard.

TABLE 1 Comparison of Frequency Standards

Standard	Principal construction feature	Principal advantage
Cesium Atomic Beam Resonator Controlled Oscillator.	Beam of free cesium atoms, spatially state selected, is subjected to a microwave signal at resonance frequency.	High intrinsic reproducibility and long-term stability. Designated as primary standard for definition of time interval.
Rubidium Gas Cell Resonator Controlled Oscillator.	Gas buffered resonance cell with optically pumped state selection.	Compact and light weight. High degree of short-term stability.
Quartz Crystal Oscillator.	Piezoelectrically active quartz crystal with electronic stabilization.	Very compact, light and rugged. Inexpensive.

Quartz Crystal Oscillators

Quartz oscillators are used in virtually every frequency control application including atomic standards. The excellent short-term stability and spectral purity of the quartz oscillators used in Hewlett-Packard atomic standards contribute to the high quality of the output signal of these standards. For less demanding applications where some long-term drift can be tolerated, quartz oscillators are used as independent frequency sources.

Frequency Standards and Clocks

Frequency standards and clocks have no fundamental differences—they are based upon dual aspects of the same phenomenon. Time and frequency are intangible quantities which can be measured only with respect to some physical quantity. The basic unit of time, the second, is defined as the duration of 9,192,631,770 periods of transition within the cesium atom. Conversely an unknown frequency is determined by counting the number of cycles over the period of a second. The Master Clock at the U.S. Naval Observatory, one of the world's most accurate clocks, is made of an ensemble of more than a dozen Hewlett-Packard cesium beam frequency standards. The USNO directly controls the distribution of precise time and time interval (frequency) from Naval radio stations, Loran-C (operated by U.S. Coast Guard), Omega and Satellite Navigation Systems. Hewlett-Packard portable cesium standards, "flying clocks," are used to periodically check the synchronization between these stations and the Master Clock.

Hewlett-Packard cesium beam standards are widely used to drive precision clocks because of the extremely good long-term stability and reliability of this primary standard. If a quartz oscillator or other secondary standard is used, it must be evaluated for rate of drift and be corrected periodically.

Time Scale

The time interval of the atomic time scale is the International Second, defined in October 1967 by the Thirteenth General Conference of Weights and Measures. Since January 1972 the frequency offset between UTC and Atomic Time has been zero and the UTC time scale is kept in synchronism with the rotation of the earth to within ± 0.9 second by step-time adjustments of exactly 1 second, when needed (see Hewlett-Packard Application Note 52-2).

The U.S. National Bureau of Standards (NBS) and USNO provide the official basis for Standard Time for the United States. The UTC signal is broadcast from the NBS stations WWV and WWVB and by several other stations throughout the world. (See Hewlett-Packard Application Note 52-1, Fundamentals of Time and Frequency Standards, for a list of stations broadcasting time signals).

Standby Power Supplies

Minimum down-time, important for any system, is vital to a time standard. Its worth depends directly on continuity of operation. Noninterrupted operation is also important to ultra-precise quartz oscillators.

Hewlett-Packard standby power supplies ensure continued operation despite line interruptions, and operate over a range of ac line voltage to supply regulated dc to operate frequency standards and frequency dividers and clocks. The batteries in the supplies assume the full load immediately when ac power fails.

Hewlett-Packard Time and Frequency Standard

The Hewlett-Packard House Standard at the Santa Clara Division consists of an ensemble of four Hewlett-Packard Cesium Beam Standards each with the Option 004 High Performance Tube.

The standard is compared to the U.S. Naval Observatory Master Clock in Washington, D.C. by means of Loran C and TV Line 10 measurements through the USASTRAT-COM satellite system. It is also compared with the U.S. National Bureau of Standards Frequency Standard (NBS FS) at Boulder, Colorado by means of Loran-C through the Naval Observatory. The frequency uncertainty of the standard is within a few parts in 10^{13} with respect to the standards maintained by the NBS and the USNO.

Time is maintained relative to the Naval Observatory and the National Bureau of Standards master clocks to an accuracy of better than ± 1.0 microseconds. This accuracy is verified with flying clock trips from the Naval Observatory to both Hewlett-Packard Santa Clara Division and Hewlett-Packard Geneva. Both locations have been designated U.S. Naval Observatory Time Reference Stations.

- 5061A
- Improved accuracy $\pm 6 \times 10^{-12}$
 - Primary standard
 - Proven reliability

- 5061A, Opt 004
- Accuracy $\pm 4 \times 10^{-12}$
 - Settability $\pm 1 \times 10^{-13}$
 - Time domain stability 5×10^{-12} (1 s avg)



5061A

5061A Cesium Beam Standard

The first Hewlett-Packard Cesium Beam Standard, the 5060A, was introduced in 1964. This was followed in 1967 with the improved 5061A and in 1973 with the high performance beam tube option for the 5061A. Since this time the accuracy and reliability of Hewlett-Packard cesium beam standards has been demonstrated and these standards have become the world-wide standard for frequency and time keeping. The 5061A has provision for an optional digital divider and reliable, easy-to-read LED clock (Option 001) and for a battery with ½ hour standby power capacity with automatic charging (Option 002).

Reliability and warranty: over 60 million operation hours have proven the performance and reliability of Hewlett-Packard cesium beam standards in various world-wide applications. The units have provided dependable microsecond accuracy in aircraft, ship and fixed environments.

A three-year warranty on the 5061A standard cesium beam tube is provided as a result of proven field reliability over an extended period. This warranty includes replacement of the cesium beam tube if it should fail within the warranty period. Typically, beam tube life has been in excess of five years.

5061A with Opt 004, High Performance Cesium Beam Tube

The Hewlett-Packard Model 5061A primary frequency standard with the Option 004 Cesium Beam Tube offers increased stability and accuracy in the instrument which has become the worldwide standard of frequency and time keeping since its introduction in 1967. Improvements in magnetic shielding, ruggedization and environmental performance permit improved performance and expansion of navigation and communication systems that have been made practical by the 5061A.

The design concept of the high performance beam tube includes unique HP designed dual beam optics with higher beam intensity to accomplish better short term stability and greater immunity to effects of shock and vibration. A 50 percent increase in resonance cavity length without change in the overall beam tube size contributes to better accuracy and settability because of the high Q of the narrower resonant line width. This tube retains the unique cesium standard feature of virtually no long term instability or aging.

The intrinsic accuracy is improved to $\pm 4 \times 10^{-12}$ which provides an excellent reference standard without need of calibration. If desired, as in many timekeeping applications, two or more units may be calibrated to determine the difference in rate or may be adjusted to the same frequency. With the improved settability specifications of 1×10^{-13} small changes in frequency are accomplished rapidly and accurately. A provision for degaussing the tube without adversely affecting the instrument operation allows removal of any residual magnetic field in the tube. This is important in achieving the settability performance.

The short term stability specification is improved by a factor of ten with this tube. The 5×10^{-12} (1 s avg.) performance compares very favorably with that of rubidium type standards which are noted for their excellent short term stability. An important advantage from the better short term stability is the capability to make measurements to 1 sigma precision of 1×10^{-12} in about one minute compared to the two hours required previously. The 5061A with the Option 004 High Performance Tube has the same high reliability as the 5061A with the standard tube. The new high performance tube is warranted for one year, but is designed to have the same long life as the standard tube.

10638A Degausser

The Model 10638A Degausser is designed for use with the Option 004 High Performance Beam Tube to achieve settability of $\pm 1 \times 10^{-13}$ and reproducibility of $\pm 3 \times 10^{-12}$. The degausser removes residual magnetic fields in the beam tube which slowly decay and cause a small frequency change. The degausser should be used when initially setting up the 5061A with Option 004 or after the instrument has been moved or adjusted.

K34-59991A Broadband Linear Phase Comparator

The K34-59991A accurately compares the phase relationship of the output signals of two frequency standards having the same nominal frequency between 100kHz and 10MHz. The comparator output signal is suitable for driving a stripchart recorder, thus allowing long-term monitoring of the frequency standards' output differences. By using this comparator, very small frequency differences can be detected and adjustments can be made to the frequency standards to correct for timekeeping errors.

E21-5061A Flying Clock

The E21-5061A consists of a 5061A Cesium Beam Standard with Option 001 LED Clock and 5089A Power Supply joined together to make one portable unit. The power supply, which can be operated from 11 to 30 V dc, 85 to 255 V ac, will provide approximately 7 hours standby power (from sealed immobilized electrolyte lead calcium batteries) for the 5061A Cesium Beam Standard.

This wide range of operating power capabilities enable the E21-5061A to operate on local power in virtually any country in the world. The seven hours standby capability make it possible to travel where there is no power available and, of course, allow the E21-5061A to conveniently be transported between power sources and operated in almost any air or surface vehicle as a "flying clock" (see Hewlett-Packard Journal, August 1966 and December 1967).

The Option 004 tube, because of the improved shielding, offers a significant increase in accuracy under the varying earth's magnetic field conditions experienced by flying clocks and is a desirable addition to the E21-5061A. In addition, the better short term stability permits more accurate and rapid comparison of standards. The Option 002 Battery may also be added to increase standby capability.



FREQUENCY & TIME STANDARDS

Atomic Frequency Standards

Models 5061A, 5065A (cont.)

- Compact, high reliability, proven performance
- Long term drift rate $< 1 \times 10^{-11}/\text{mo}$
- Time domain stability $< 5 \times 10^{-13}$ (100 s, avg)

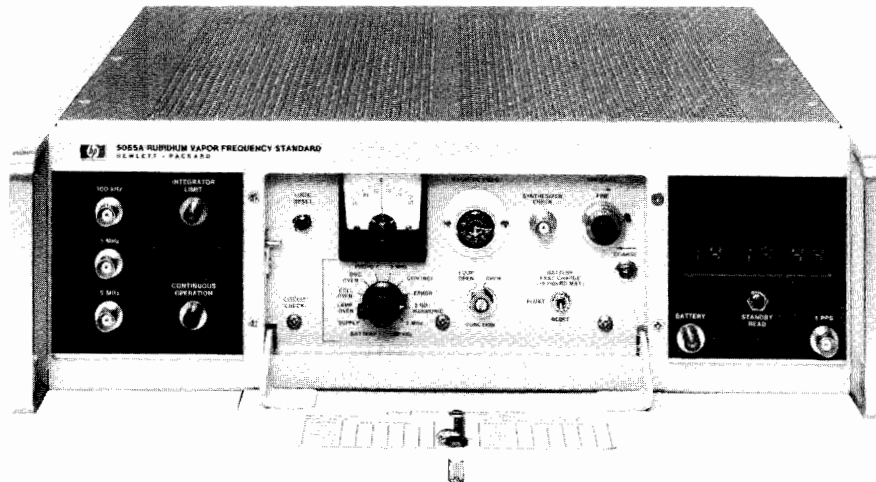

5065A Rubidium Frequency Standard

The HP Model 5065A is an atomic-type secondary frequency standard which uses a rubidium vapor resonance cell as the stabilizing element. As a result, it has long-term stability of better than 1×10^{-11} per month which exceeds that of high quality quartz oscillator frequency standards by 50 to 100 times. Furthermore, it has excellent short-term stability. These features contribute to its desirability as a coherent signal source, as a master oscillator for radio and radar systems where special requirements for stability and/or narrow bandwidth must be met, as a precision time keeper where the better performance of a cesium beam primary standard is not required, and as a house frequency standard for improved accuracy with fewer NBS calibrations compared to that required with quartz standards.

Front panel controls and circuit check meter of the 5065A are protected by a panel door. The magnetic field control provides fine frequency adjustment with which the frequency can be set to a precision of better than 2×10^{-12} without reference to a chart. The 5 MHz low noise quartz oscillator is phase-locked to the atomic frequency and provides the standard 5 MHz, 1 MHz, and 100 kHz outputs. The circuit check meter with selector switch monitors key voltages and currents for routine maintenance readings, calibration procedures, and fault finding.

The 5065A is designed for assured operation—to give the user confidence that the standard output signals are correct and locked to the atomic frequency. Logic within the unit maintains power to a “continuous” operation light on the front panel. If operation is interrupted, even momentarily, for any reason the light goes out and stays out until manually reset. An integrator limit light warns when the frequency correcting servo loop is approaching the limit of its dynamic range.

The HP Model 5065A is contained in a small-size package and is lightweight in comparison to a cesium beam standard. Additionally the rubidium resonance cell is much more frequency stable than quartz oscillators while subjected to shock and vibration, EMC, humidity, and magnetic field effects.

Reliability and warranty: the most significant module in the HP 5065A in terms of performance is the Rubidium Vapor Frequency Reference (RVFR). This temperature controlled, magnetically shielded unit includes the Rb gas cell and a photo sensitive detector

designed for maximum possible reliability. Field experience, including several million hours of operation, have demonstrated this reliability and the module is now warranted for a period of three years. This increased warranty protects the owner in the event of random failure.

The Option 001 Digital Clock has an easy to read LED time-of-day display. The olive black upper panel provides a dark background around the readout for excellent contrast and readability. Initial clock setting is accomplished by means of pushbuttons easily accessible by removing the top cover. The LED display offers high reliability, freedom from errors due to mechanical shock, and performance over the full environmental range of the 5065A. A sync button on the digital divider permits automatic synchronization of this 1 PPS pulse to an external pulse. The clock 1 PPS is adjustable in decade steps from $1 \mu\text{s}$ to 1 s, with respect to the synchronized reference, with 6 thumbwheel switches. A screwdriver adjustment allows fine continuous adjustment over a range of $1 \mu\text{s}$.

To conserve battery power, the display is not illuminated when ac power is not available. A STANDBY READ pushbutton below the display is used for readout when operating on the internal battery or external dc.

The Option 002 Standby Battery provides the 5065A with a minimum of 10 minutes standby power at 25°C . Switchover from line to battery is automatic so there is no interruption of operation if ac line power should fail. A front panel ac interruption light warns when ac power has failed or has been disconnected. Fast or float charging rates may be selected when ac power is available.

The Option 003 combines the Option 001 Clock and Option 002 Battery and should be specified if both Options 001 and 002 are required.

E21-5065A Portable Time Standard

E21-5065A Portable Time Standard is a complete system for precision timekeeping and for transporting time from one location to another. It consists of the 5065A Rubidium Standard with digital clock and divider (Option 001) and the 5089A Power Supply with 6 or more hours standby capability. The component units are held together by side bars, and the interconnecting cables are protected by a back cover.

Specifications

Instrument:	5061A Option 004		5061A		5065A
Type of Standard:	Cesium		Cesium		Rubidium
Accuracy: maintained in magnetic field to 2 gauss and over temperature range of:	$\pm 7 \times 10^{-12}$ 0 to 50°C	$\pm 4 \times 10^{-12}$ $\pm 2.5^\circ\text{C}$ in range of 15 to 35°C	$\pm 1 \times 10^{-11}$ 0 to 50°C	$\pm 6 \times 10^{-12}$ $\pm 2.5^\circ\text{C}$ in range of 15 to 35°C	
Stability:					
Long Term:					
Short Term 5 MHz ⁽²⁾ :	Averaging time: 0.01	$\pm 3 \times 10^{-12(1)}$ 1.5×10^{-10}	$\pm 5 \times 10^{-12(1)}$ 1.5×10^{-10}		$\pm 1 \times 10^{-11}$ / month 1.5×10^{-10}
	1	5×10^{-12}	5.6×10^{-11}		5×10^{-12}
	10	2.7×10^{-12}	2.5×10^{-11}		1.6×10^{-12}
	100	8.5×10^{-13}	8×10^{-12}		5×10^{-13}
SSB Phase Noise Signal (1 Hz BW) Offset from signal:	Hz: 10^{-3}	-28 dB	-8 dB		-25 dB
	10^{-2}	-48 dB	-28 dB		-52 dB
	10^{-1}	-68 dB	-48 dB		-72 dB
	0	-96 dB	-82 dB		-93 dB
	10^1	-120 dB	-120 dB		-120 dB
	10^2	-125 dB	-125 dB		-126 dB
	10^3	-140 dB	-140 dB		-140 dB
Reproducibility ⁽⁴⁾ :	$\pm 3 \times 10^{-12(3)}$		$\pm 5 \times 10^{-12}$		
Settability (frequency) ⁽⁵⁾ :	$\pm 1 \times 10^{-13(3)}$		$\pm 7 \times 10^{-13}$		$\pm 2 \times 10^{-12}$
Warm-up:	At 25°C 30 Min.		At 25°C 45 Min.		At 25°C 1×10^{-10} 1 hr. 5×10^{-11} 4 hrs.
Sinusoidal Outputs: Output Voltage	5 MHz, 1 MHz, 100 kHz, Front & Rear BNC 1 V into 50 ohms				
Harmonic Distortion: (below rated output)	>40 dB		>40 dB		>40 dB
Non-Harmonic related output: (below rated output)	>80 dB		>80 dB		>80 dB
Under vibration or AC Mag Field:	>60 dB		>60 dB		>60 dB
Signal-to-Phase Noise Ratio in 30 kHz noise BW (1 and 5 MHz):	>87 dB		>87 dB		>87 dB
Environmental DC Magnetic Field Stability:	$< \pm 2 \times 10^{-13}$ 2 Gauss Field $< 2 \times 10^{-12}$ for 2 Gauss peak		$< \pm 2 \times 10^{-12}$ 2 Gauss Field $< 2 \times 10^{-12}$ for 2 Gauss peak		$< \pm 5 \times 10^{-12}$ 1 Gauss Field $< 5 \times 10^{-12}$ for 1 Gauss peak
AC Magnetic Field: 50, 60 and 400 Hz $\pm 10\%$	0 to 50°C		0 to 50°C		0 to 50°C
Temperature, operating with Option 001 or 002 Freq. change from 25°C:	$< 5 \times 10^{-12}$		$< 5 \times 10^{-12}$		$< 4 \times 10^{-11}$
Temperature, non-operating without options: with Option 001:	-40°C to 75°C		-40°C to 75°C		-40°C to 75°C
with Option 002:	-40°C to 50°C		-40°C to 50°C		-40°C to 50°C
NOTES:					
(1) For life of beam tube.					
(2) Short-term stability for the 5061A with both standard and high performance tubes is given for the normal loop time constant. For improved short-term stability in controlled environments the long time constant may be used.					
(3) With 10638 Degausser.					
(4) Degree to which an oscillator will produce the same frequency from one occasion to another without recalibration.					
(5) Degree to which frequency can be set to agree with a reference frequency.					

FREQUENCY & TIME STANDARDS

Atomic Frequency Standards

Models 5061A, 5065A (cont.)

Instrument	5061A Opt 004	5061A	5065A
Vibration: with isolators:	MIL-STD-167-1 MIL-T-21200	MIL-STD-167-1 MIL-T-21200	MIL-STD-167-1
Shock:	MIL-E-5400, Class 1 (30G)		
	1-MIL-T-21200, C.1		MIL-T-21200, C.1
EMC:	MIL-STD-461, Notice 3, Class A		
General			
Power: AC:	50, 60 or 400 Hz \pm 10%, 115/230 V \pm 10%		
DC:	43 W 22 to 30 V 27 W	43 W 22 to 30 V 27 W	49 W 23 to 30 V 35 W
Option 001: add (AC/DC)	10/7.5 W	10/7.5 W	10/7.5 W
002: add (AC/DC)	22/4.5 W	22/4.5 W	6/0 W
010: add (AC/DC)			
Dimensions (H x W x D): mm: inches:	221 x 425 x 416 8.7 x 16.7 x 16.4	221 x 425 x 416 8.7 x 16.7 x 16.4	133 x 425 x 416 5.2 x 16.7 x 16.4
Weight: (lb/kg)	70/31.8	67/30.5	34/15.4
Option 001: add (lb/kg)	2/0.9	2/0.9	2/0.9
002: add (lb/kg)	5/2.3	5/2.3	3.5/1.6
Option 001, Clock			
1 PPS Outputs: Master:			
Clock:	Front & Rear BNC	Front & Rear BNC	Front & Rear BNC
Amplitude:	10 V peak into 50 Ω load		
Width:	20 μ s min	20 μ s min	20 μ s min
Rise Time:	<50 ns	<50 ns	<50 ns
Fall Time:	<2 μ s	<2 μ s	<2 μ s
Jitter, pulse-to-pulse:	<5 ns, rms	<5 ns, rms	<5 ns, rms
Synchronization:	Automatic, 10 \pm 1 μ s delay	Automatic, 10 \pm 1 μ s delay	Auto., 10 \pm 1 μ s delay
Clock pulse adjustment range:	1 μ s to 1 s	1 μ s to 1 s	1 μ s to 1 s
Clock display:	Solid State Digital		
Option 002, Standby Power Supply Capacity at 25°C with Option 001 Clock:	30 Minutes	30 Minutes	10 Minutes
Recharge, Fast/Float:	Automatic, fast charge		Switch

Ordering Information

5061A Cesium Beam Frequency Standard

- Opt 001:** Clock
- Opt 002:** Standby Power Supply
- Opt 003:** Clock and Standby Power Supply
- Opt 004:** High Performance Beam Tube
- Opt 908:** Rack Flange Kit

E21-5061A Flying Clock

- Consists of:** 5061A with Opt 001 (not included in E21 price) and 5089A Standby Power Supply.
- Weight:** 64 kg (141 lb).
- Size:** 425 H x 405 W x 546 mm D (16.7" x 15.9" x 21.5") (includes handles).

10638A Degausser

- Weight:** 1.2 kg (3 lb).
- Size:** 130 H x 77 W x 279 mm D (5.1" x 3" x 11").

5065A Rubidium Frequency Standard

- Opt 001:** Clock
- Opt 002:** Standby Power Supply
- Opt 003:** Clock and Standby Power Supply
- Opt 908:** Rack Flange Kit

E21-5065A Portable Time Standard

- Consists of:** 5065A with Opt 001 (not included in E21 price) and 5089A Standby Power Supply.
- Weight:** 50 kg (110 lb).
- Size:** 425 H x 405 W x 546 mm D (16.7" x 15.9" x 21.5") (includes handles).

- High spectral purity
- Well-buffered outputs
- Aging $< 5 \times 10^{-10}$ per day

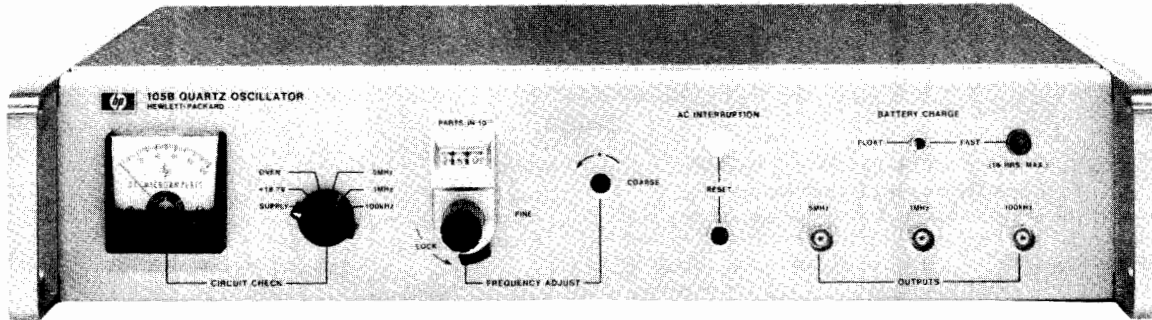

105B

The HP 105B Quartz Oscillator provides state-of-the-art performance in precision frequency and time systems because of its excellent long and short term stability characteristics, spectrally pure output, unexcelled reliability, and ability to operate under a wide range of environmental conditions. The HP 105B fills a need for a small and economical yet highly stable precision quartz oscillator for frequency and time standards. The 105B can be operated from the ac line. It also has a built-in 8-hour standby battery for uninterrupted operation should line power fail. The 5 MHz, 1 MHz and 100 kHz buffered sinusoidal outputs have excellent short term stability (5 parts in 10^{12} rms for 1 s averaging time) and aging rate (< 5 parts in 10^{10} per day).

The 105B features rapid warm-up. Typically, the oscillator will be within 5 parts in 10^9 of the final frequency in 15 minutes after an "off" period of 24 hours. The basis of these oscillators is an extremely stable "SC" cut quartz crystal developed by Hewlett-Packard. New technologies in the crystal mounting and packaging have resulted in a cleaner crystal which in turn has a lower aging rate. The crystal, oscillator and AGC circuit are all enclosed in a proportional oven which reduces the temperature effects on these components and circuits.

Particular care was taken to provide a spectrally pure 5 MHz output which, when multiplied high into the microwave region, provides signals with spectra only a few cycles wide. Spectra less than 1 Hz wide can be obtained in X-band (8.2 to 12.4 GHz). The stability and purity of the 5 MHz output make it suitable for doppler measurements, microwave spectroscopy, and similar applications where the reference frequency must be multiplied by a large factor.

Specifications

Outputs: 5 MHz, 1 MHz, 100 kHz; 1 V rms into 50 Ω front and rear connectors.

Clock output: 1 MHz or 100 kHz; 0.5 V rms into 1 k Ω , rear connector. Normally supplied wired for 1 MHz output.

Frequency Stability

Aging rate: $< 5 \times 10^{-10}$ per 24 hours.

Short-term stability: for 5 MHz output only.

τ (sec)	$\sigma\Delta f/f(2,\tau)$
10^{-2}	1.5×10^{-10}
10^{-1}	1.5×10^{-11}
10^0	5×10^{-12}

Temperature: $< 2.5 \times 10^{-9}$ total change 0°C to 50°C .

Load: $\pm 1 \times 10^{-10}$ open to short circuit, 50 Ω R, L or C load change.

Supply voltage: $\pm 5 \times 10^{-11}$ for 22–30 V dc from 26 V dc reference and for 115/230 V $\pm 10\%$.

Warm-up (at 25°C): to within 5×10^{-9} of final frequency in 15 min.

Distortion (5 MHz, 1 MHz, 100 kHz) Below Rated Output

Harmonic: > 40 dB.

Non-harmonic: > 80 dB.

Frequency Adjustments

Fine: $\pm 5 \times 10^{-8}$ range with digital dial reading parts in 10^{10} .

Coarse: 1×10^{-6} front panel screwdriver control.

Phase locking: external +5 V to -5 V allows $> 2 \times 10^{-9}$ frequency control for locking to external source.

Environmental

Temperature, operating: 0°C to $+50^\circ\text{C}$.

Temperature, storage: -40°C to $+75^\circ\text{C}$ ($+50^\circ$ for 105B).

Altitude: 15.24 km (50,000 ft.).

Shock: MIL-T-21200 (30 Gs).

Vibration: MIL-STD-167 and MIL-T-21200.

Electromagnetic compatibility (EMC): MIL-1-6181D.

Standby supply capacity: 6 hours at 25°C ambient temperatures.

Power requirements: 115/230 V $\pm 10\%$, 50–400 Hz at 18 W (70 W warm-up) Add 1 W for float charge and 12 W for fast charge. 22–30 V dc at 8 W (16 W warm-up).

Size: 88 H x 425 W x 286 mm D ($3\frac{15}{32}$ " x $16\frac{3}{4}$ " x $11\frac{1}{4}$ ").

Weight: 105B—net, 11 kg (24 lb). Shipping, 14 kg (31 lb).

Options

908: Rack Flange Kit

910: Extra manual

105B Quartz Oscillator

FREQUENCY & TIME STANDARDS

Distribution Amplifier

Model 5087A

- Versatile with 3 input and 12 output channels
- Low noise, high stability, and isolation

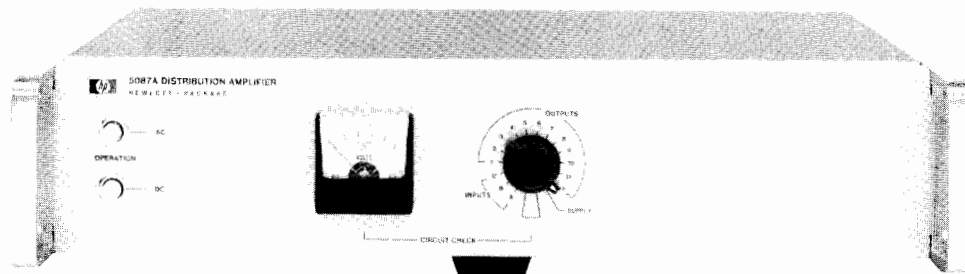

The Hewlett-Packard Model 5087A Distribution Amplifier provides the isolation and flexibility required for distribution of the output of high quality frequency standards. Low distortion and excellent isolation make it ideal for providing multiple outputs from atomic or crystal frequency standards. The 3 input channels will accept 10 MHz, 5 MHz, 1 MHz or 100 kHz in any combination. The number of outputs for each channel is selectable up to a total of 12 outputs. The output levels are individually adjustable from 0 to 3 V rms. All input and output levels are monitored on a front panel meter.

The Distribution Amplifier features plug-in modular construction, short circuit isolation, exceptional phase stability, low noise and cross-talk, and uninterrupted switchover to standby dc in event of a power failure.

The shielding around each input and output plug-in amplifier assures minimum noise and crosstalk. The tuned output amplifiers provide clean signals and high channel-to-channel isolation.

The instrument is designed for maximum versatility and can be supplied to meet a wide variety of special requirements. The standard configuration of input and output amplifiers is shown in Figure 1.

Several other commonly used configurations are also available and special combinations of the various input and output modules can be supplied. Input and output amplifiers can be added or the configuration easily changed at any time.

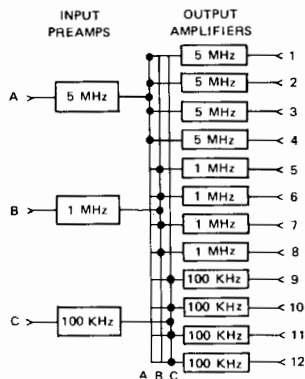

Figure 1. 5087A Distribution Amplifier with Option 031, Standard Configuration input and output amplifiers.

Specifications

- Inputs:** (up to three, rear panel BNC).
Frequencies: 10 MHz, 5 MHz, 1 MHz or 100 kHz.
Level: 0.3 to 3.0 V rms, 50 ohms.
- Outputs:** (up to 12 rear panel BNC).
Frequencies: 10 MHz, 5 MHz, 1 MHz or 100 kHz.
Level: 0–3 V into 50 ohms (screwdriver adjustment).
Harmonic distortion: >40 dB below rated output.
Non-harmonic distortion: >80 dB below rated output

Isolation

Load (open or short on any other channel)

- Amplitude change:** 0.1 percent.
Phase change: <0.1 ns at 5 or 10 MHz.
 <0.5 ns at 1 MHz.
 <5.0 ns at 100 kHz.

Injected signal: 1 V signal up to 50 MHz applied to any output except 10 MHz, will be down more than 60 dB in all other outputs; 10 MHz output channel will be down more than 50 dB.

SSB phase noise (5 MHz): >145 dB below signal in 1 Hz BW for frequencies > 1 kHz from carrier.

Short term stability degradation (5 MHz): < 1 x 10⁻¹² in 10 kHz band. (1 s average).

Environmental

- Temperature:** MIL-E-16400, Class 4.
Operating: 0–50°C; storage: –62° to +75°C.

Stability:

- Amplitude:** ±0.5 dB, 0° to 50°C.
Phase: <0.1 ns/°C., 5 and 10 MHz.

EMC: MIL-STD-461A.

Humidity: 95% at 40°C.

Vibration: MIL-STD-167.

Altitude: up to 30,000 ft.

Shock: MIL-T-21200, Class 1 and MIL-E-5400 (30 Gs).

General

Power: 115 or 230 V ±10%, 48 to 440 Hz, 20 VA, max, or 22–30 V dc, 500 milliamperes, max.

Dimensions: 88 H x 425 W x 286 mm D (3.5" x 16.7" x 11.3").

Weight: typical, Opt 031–Net 7 kg (15 lb).

Options

Normal Configurations (input and output amplifiers)

- 031:** 5, 1 and 0.1 MHz inputs and 4 outputs at each frequency
032: Single 5 MHz input and 12 outputs
033: Single 10 MHz input and 12 outputs
034: Single 5 MHz input, 4 each outputs at 5, 1 and 0.1 MHz

Special Configurations

Input Preamplifiers (up to 3 total)

- 004:** Input Preamplifier (0.1 to 10 MHz)
005: 5 to 1 MHz Input Divider
006: 1 to 0.1 MHz Input Divider
011: 5 to 10 MHz Input Doubler
013: 10 to 5 MHz Input Divider
014: 10 to 1 MHz Input Divider

Output Amplifiers (up to 12 total)

- 001:** 5 MHz Output Amplifier
002: 1 MHz Output Amplifier
003: 0.1 MHz Output Amplifier
012: 10 MHz Output Amplifier
908: Rack Flange Kit

5087A: Distribution Amplifier Mainframe

FREQUENCY & TIME STANDARDS

Standby Power Supply

Model 5089A

277



- 15 Amp-hour capacity
- Maintenance free lead-calcium batteries
- Used in "Flying Clocks"
- Automatic recharge

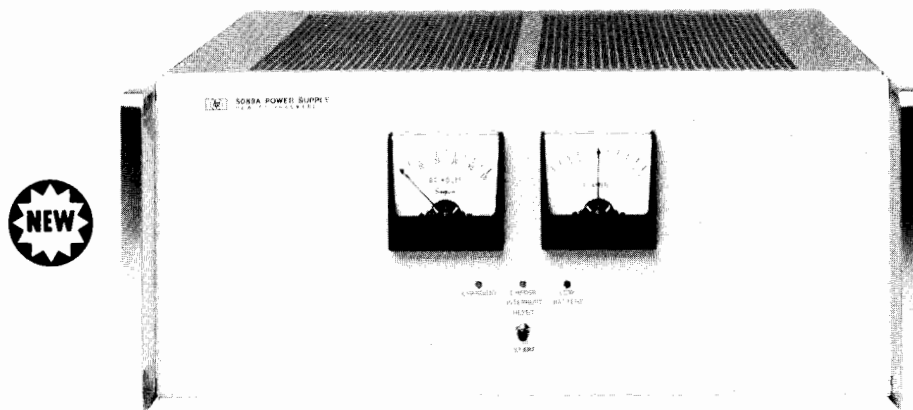

5089A Standby Power Supply

The HP Model 5089A Standby Power Supply furnishes dc power to keep frequency or time standard systems operating during extended interruptions of ac line power. For applications where it is essential to maintain continuous operation and avoid loss of precise time, the use of a standby power supply is an absolute necessity. This unit is designed for use with the Hewlett-Packard Cesium Beam Standards, Rubidium Vapor Standards, Quartz Oscillators, and other equipment which will operate from 22 to 28 V dc. No switching is used in transferring power from line to battery operation and back again, thus assuring uninterrupted operation.

Versatility

The 5089A is an extremely versatile unit. It was designed both as a portable power supply for the 5061A and 5056A "flying clocks", and as a standby supply for stationary applications.

Portable Applications

Portable or "flying clock" applications require a power supply to operate from a wide range of power sources, along with the standby capability to maintain continuous operation where no external power is available. A special inverter permits operation from a 12V dc automobile battery. In addition, the 85 to 255 V ac, and 11 to 30 V dc capability enables the 5089A to operate from almost any power source in the world. The 15 ampere-hour standby batteries are the double sealed lead-calcium type, and thus are virtually spillproof. Mounting hardware is available to attach the 5089A to either the 5061A or the 5065A standards to make a portable frequency time standard package. These portable packages are available from Hewlett-Packard under model numbers E21-5061A and E21-5065A.

Stationary Applications

Stationary applications require long periods of power supply operation in a float or standby mode. Then when an ac supply failure occurs the supply must provide full standby capability. The charging circuits inside the 5089A are designed to charge the batteries in such a way that they will provide both long, trouble-free, reliable operation, and full standby power. After use, when ac power is restored, the 5089A will fully recharge its batteries. The double sealed batteries will not leak nor require maintenance of any kind. Thus, the 5089A allows you to add standby capability to your system with very little increase in maintenance costs.

Ease of Operation

In normal operation there is virtually no required operator intervention. The 5089A automatically maintains the batteries in a fully charged state, ready to supply standby power. Should regular line power fail, the 5089A will provide uninterrupted dc power (to the limit of its standby capacity) for your equipment. After normal operating power is restored, the 5089A will automatically recharge its batteries back to the standby level.

The 5089A tells you its operational status at a glance through three LED lamps: GREEN indicates the battery is being charged; YELLOW indicates there has been an ac line failure; a RED lamp lights when the battery is almost fully discharged. Two front-panel meters show battery voltage and charge/discharge current.

Batteries

The 5089A utilizes the "immobilized electrolyte" technology in its maintenance-free lead-calcium batteries. The lead-calcium grid gives these batteries longer life with better reliability than conventionally designed batteries. The batteries are double sealed to provide virtually leakproof, and thus maintenance-free operation.

5089A Specifications

Input Voltage

AC charging: 85V to 130V ac rms, 48 to 440 Hz, 300 VA max
85V to 255V ac rms, 48 to 66 Hz, 300 VA max

DC operation: 11V to 30V dc, 110W max

Output voltage: 22V to 28V dc (nominal), 2A maximum.

Standby capacity: 15AH at +25°C when fully charged.

Recharge: complete recharge in 24 hours when operating from AC line.

External low battery voltage alarm: floating contact closure at rear panel barrier block for external visible or audible "low battery" warning. Contact rating is 30V dc at 2 amperes.

Operating Environment

Temperature: 0°C to 50°C

Humidity: up to 95% at 40°C (with no internal condensation)

Altitude: 4,600 metres (15,000 feet)

Storage Environment

Temperature: -40°C to +65°C

Humidity: up to 95% noncondensing

Altitude: 4,600 metres (15,000 feet)

Dimensions: 177mmH x 425mmW x 416mmD (7" x 16.7" x 16.4")

Weight: net weight 30.5kg (67 pounds)

Accessories Supplied

05061-6091: AC Power Input Cable Assembly

05089-60102: DC Power Input Cable Assembly

05089-60101: DC Output Cable Assembly

5060-0169: Extender Board Assy (Dual 25 Pin)

Options Available

Option 001: Spare AI Board Assembly (05089-60001)

Option 908: Rack Mounting Adapter Kit

Option 910: Extra Operating and Service Manual

5089A Standby Power Supply

ELECTRONIC COUNTERS

General Information

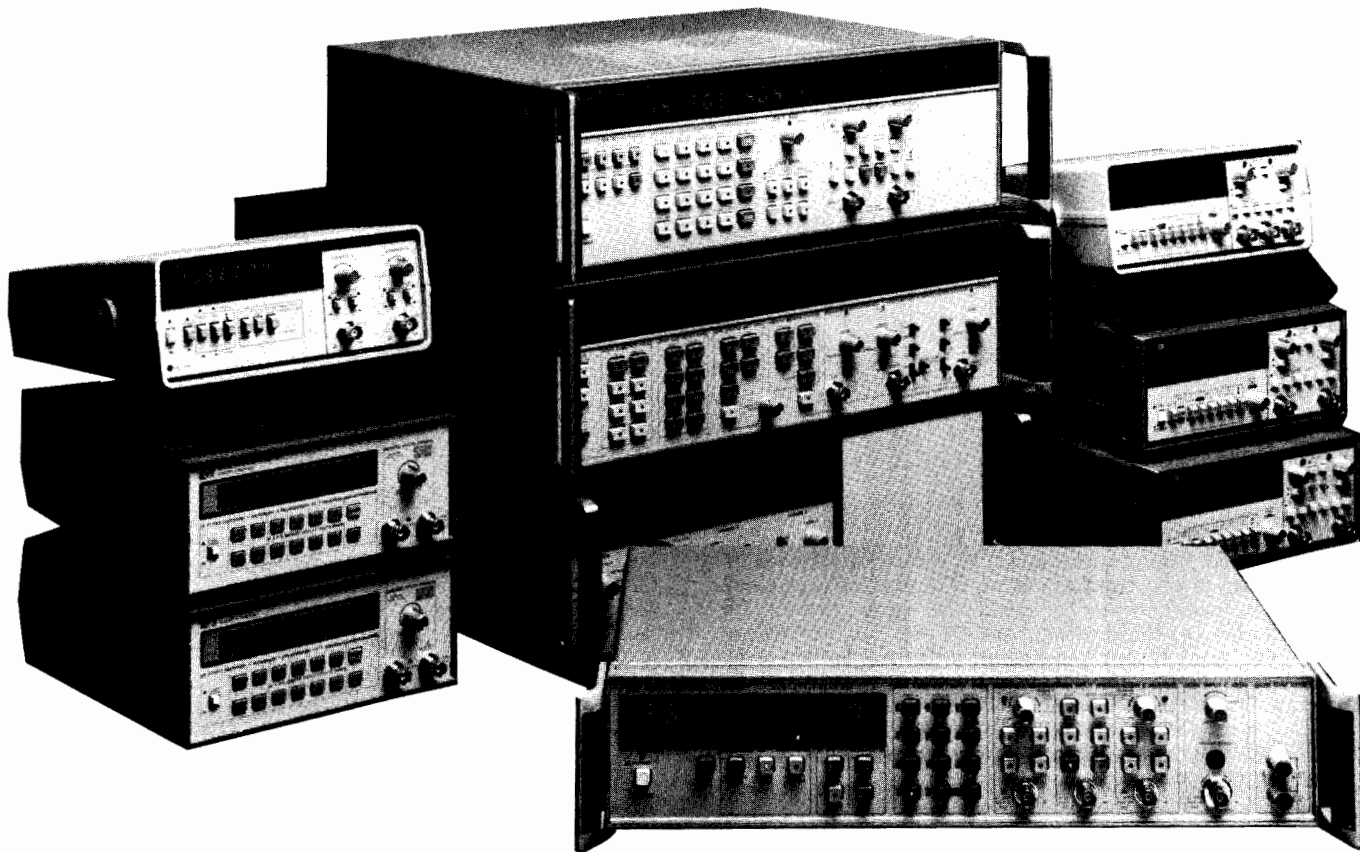

Introduction

HP introduced its first digital electronic counter in 1952. That product, the 524A, could measure frequencies to 10 MHz and time intervals as short as 100 ns. Thirty years later HP counters measure frequencies as high as 40 GHz and time intervals as short as 20 picoseconds, the time it takes light to travel six millimeters.

Applications for counters exist throughout the electronics industry, in all phases of engineering, production and service. Today's counters make a variety of measurements, which are summarized below.

Frequency

In this fundamental measurement, the counter totalizes cycles of the unknown signal for a precisely known length of time. Using high speed custom ECL parts, counters today measure frequency to 500 MHz directly and to 40 GHz with down conversion. Measurement quality is closely linked to the timebase and HP counters feature a variety of high stability oscillators to match the requirements of the application.

Period

The inverse of frequency measurement is available on most products to provide high resolution measurement of low frequency.

Totalize

This measurement is similar to frequency except that the user controls the time interval

over which the measurement takes place. Applications for totalize range from mechanical systems to high speed electronics R & D. The ability of the 5345A to totalize at a 500 MHz rate represents the current state of the art for this measurement.

Ratio

Some counters have the ability to compute and display the ratio of two input frequencies. The major application is the measurement of harmonically related signals.

Scaled Output

A divide by N version of the input signal is available at the timebase output of the 5328A for specialized applications.

Time Interval

The importance of the digital techniques throughout the electronics industry makes high resolution measurement of time interval increasingly useful. Seven HP counters make time interval measurements including the 5370B which uses phase locked vernier interpolation to measure time interval as short as 20 picoseconds. Time interval averaging, a technique pioneered by HP, improves the resolution of measurements made on repetitive signals over the single shot resolution of the counter. Another product, the 5363B Time Interval Probe, aids time interval measurements by expanding the dynamic range of trigger levels and reducing uncertainties caused by trigger level errors.

Pulse Parameters

HP's newest counter, the 5334A, has complete pulse characterization capability which includes peak amplitude measurement, a feature not previously available in counters. Along with peak amplitude, the 5334A can also measure pulse width and rise/fall times. On the 5335A counter the measurement hardware is combined with the power of a microprocessor to make complex measurements easier and faster. At the touch of few keys, the 5335A automatically measures phase, slew rate, duty cycle, rise/fall times, and computes statistics.

Reciprocal Counting

All newer HP counters measure frequency by counting the internal clock for a known number of periods of the input signal and computing frequency. This technique, known as reciprocal counting, makes the resolution of the measured frequency proportional to the frequency of the timebase rather than the one Hertz in one second resolution of conventional counters. Reciprocal counting is necessary for high resolution low frequency measurements. In keeping with HP's commitment to advanced measurement technology, the capability of frequency counting was extended with the introduction of interpolator-enhanced reciprocal counting with the 5335A. This technique allows, not only 5335A, but also the newest counters, the 5334A, 5384A and 5385A, to obtain 9-digit per second low frequency resolution at low cost.



Categories of Frequency Counters

While counters can potentially offer all of the capabilities described above, they essentially fall into three categories, frequency counters, universal counters, and microwave counters.

Frequency counters offer basic frequency measurement. They are designed for people with specific applications and the wide variety of products in this area insure that one is available to economically match most applications. The newest additions to this category, the 5384A and 5385A, also offer full systems compatibility with either HP-IB or HP-IL.

Universal counters provide time interval measurement capability in addition to the other measurements found in frequency counters. The 5314A is the most economical of HP universal counters and features 100 MHz frequency and 100 nanosecond time interval. At the other extreme the 5370B measures time intervals of 20 picoseconds single shot. In between, the 5315A/B, 5316A, 5328A, 5334A, 5335A, and 5345A offer a range of capabilities that are more fully described in the comparison chart below.

HP microwave counters make high accuracy frequency measurements at frequencies up to 40 GHz. The 5343A automatically measures frequencies to 26.5GHz with one

Hertz resolution and wideband FM tolerance. For pulsed RF or CW microwave applications, the 5355A plug-in for the 5345A is a complete solution to 40GHz.

The 5344S Microwave Source Synthesizer is a recent addition to the HP Microwave Counter family. When used with microwave sweepers such as the HP 8350A, the 5344S greatly improves frequency accuracy for network measurements.

Most HP counters are compatible with the HP Interface Bus, Hewlett-Packard's implementation of IEEE-488, when equipped with the HP-IB option. In fact, all newer HP counters (the 5316A, 5334A, 5335A, 5370B, 5384A and 5385A) come equipped with HP-IB standard. This makes them ideal for applications requiring a large number of time or frequency measurements, frequent changes of the front panel settings or automatic data reduction storage and output.

HP-IL

The 5384A and 5385A counters provide frequency and period measurement capability for low cost HP-IL systems. HP-IL is HP's new two-wire serial interface that allows remote instrument control via HP 41C/CV handheld calculators or the more powerful HP series 80 computers.

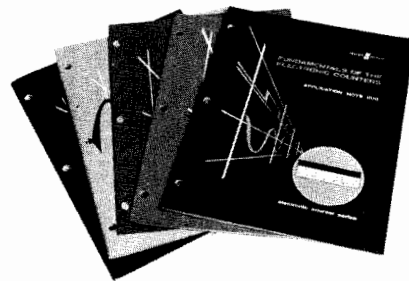

The 200 series of application notes, shown above, explains in detail the operation and application of HP's frequency counters.

- Topics include:
- Fundamentals of Electronic Counters 200
 - Fundamentals of Microwave Counters 200-1
 - Fundamentals of Quartz Oscillators 200-2
 - Fundamentals of Time Interval Measurements 200-3
 - Understanding Counter Specifications 200-4
- These notes are available from all HP sales offices.

HP-IL Interface Loop

Category	Model	Counting Technique	Number of Digits	Sensitivity	Frequency	Single Shot Time Interval	HP-IB Standard	Other	Page Number
Frequency Counters	5381A	Conventional	7	25 mV	80 MHz	—	—	—	303
	5382A	Conventional	8	25 mV	225 MHz	—	—	—	303
	5383A	Conventional	9	25 mV	520 MHz	—	—	—	303
	5384A	Reciprocal	11	15mV	225 MHz	—	Yes ³	HP-IL	302
	5385A	Reciprocal	11	15mV	1000 MHz	—	Yes ³	HP-IL	302
Universal Counters	5314A	Conventional	7	25 mV	100 MHz	100 ns	—	P,R,T	301
	5315A	Reciprocal	8	10 mV	100 MHz	100 ns	—	P,R,T	298
	5315B	Reciprocal	8	10 mV	100 MHz	100 ns	—	P,R,T ¹	298
	5316A	Reciprocal	8	10 mV	100 MHz	100 ns	Yes ³	P,R,T	298
	5328A	Conventional	8	25 mV	100 MHz	100 ns	Yes	P,R,T	296
	5334A	Reciprocal	9	35 mV	100 MHz	2 ns	Yes ³	P,R,T ²	294
	5335A	Reciprocal	12	25 mV	200 MHz	2 ns	Yes ³	P,R,T ²	291
	5345A	Reciprocal	11	20 mV	500 MHz	2 ns	Yes	P,R,T	280
	5370B	Reciprocal	12	20 mV	100 MHz	20 ps	Yes ³	P,Statistics	288
Microwave	5340A	Conventional	8	-35 dBm	18 GHz	—	Yes	—	287
	5342A	Conventional	11	-25 dBm	18 GHz	—	Yes	Amplitude, D to A	284
	5343A	Conventional	11	-33 dBm	26.5 GHz	—	Yes	—	284
	5355A	Conventional	11	-15 dBm	1.6 GHz	2 ns	Yes	P,R,T	283
	5356A	Conventional	11	-20 dBm	18 GHz	2 ns	Yes	P,R,T	283
	5356B	Conventional	11	-20 dBm	26.5 GHz	2 ns	Yes	P,R,T	283
	5356C	Conventional	11	-20 dBm	40 GHz	2 ns	Yes	P,R,T	283

P Period

R Ratio

T Totalize

1. Offset and normalize—Option 006
2. Pulse characteristics, phase, math, statistics
3. HP-IB Standard

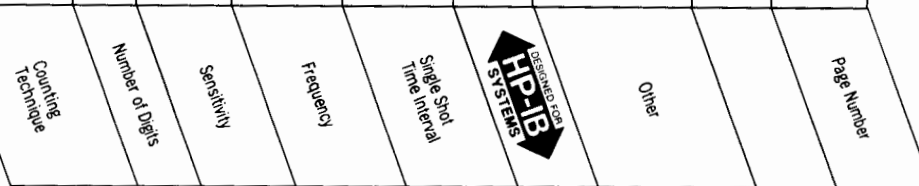

ELECTRONIC COUNTERS

500 MHz Plug-In Counter

Model 5345A

- DC to 500 MHz direct counting
- 2 ns single shot T.I. resolution
- Averaging to 2 ps resolution
- 20 mV sensitivity to 500 MHz
- Plug-in measurements to 40 GHz
- Full HP-IB programming optional

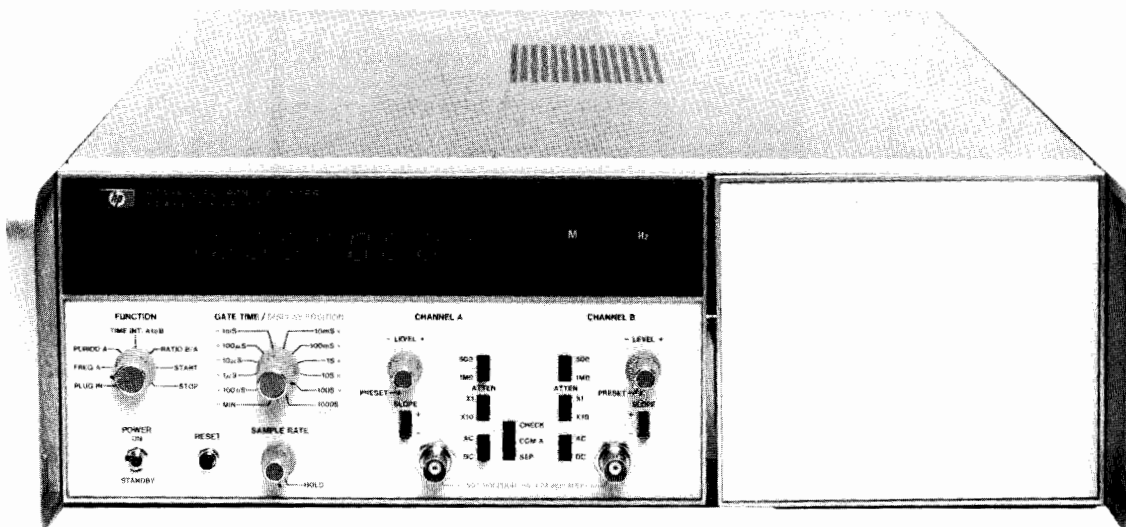

The 5345A Electronic Counter represents one of the most advanced general purpose instruments in the Hewlett-Packard Counter Product Line. Utilizing monolithic bipolar integrated circuit technology especially designed and manufactured at Hewlett-Packard, this instrument provides unsurpassed power, versatility and flexibility in frequency and time measurements. The 5355A plug-in (p. 283) extends the capability and frequency range of the 5345A mainframe.

Input Signal Conditioning

The fully optimized front end includes switchable 50 Ω/1MΩ input impedance, dc/ac coupling, and slope selection. The sensitive wideband amplifiers assure measurements on even the lowest level sinusoidal and digital signals. Also featured is an extremely wide linear dynamic range of -2 to +0.5 Vdc.

Frequency measurements are made direct from dc to 500 MHz. Using the reciprocal technique, 9 digits of resolution occur in a one second gate time over the entire frequency range. This means a 1 MHz input can be resolved to 2×10^{-9} (= 0.002 Hz) in one second.

This high resolution in a short period of time can be traded for greater measurement speeds. Using a 100 μs gate with a resolution of 2×10^{-5} the measurement can now be made 5000 times a second. Up to 9000 readings a second can be output to the Interface Bus using the computer dump mode.

Measurement Speed

Mode of Operation	Readings per Second
Normal Operation (Max sample rate)	10
Externally armed	500
Externally gated	500
Computer dump	9,000

Time Interval

Single-shot time interval resolution is 2 ns. Time interval averaging on repetitive inputs can improve resolution to 2 ps. Due to a modulated clock technique, true averaging occurs under all conditions. Also helpful in time interval applications is knowing where triggering on the input signal occurs. This can be determined by simply measuring the dc trigger levels at rear panel BNCs.

External Gating Capability

Via the rear panel gate control input, the operator can determine at what point in real time and for how long the measurement is to be made. The major application is in the measurement of pulsed RF signals, using frequency averaging to improve resolution (see Figure 1).

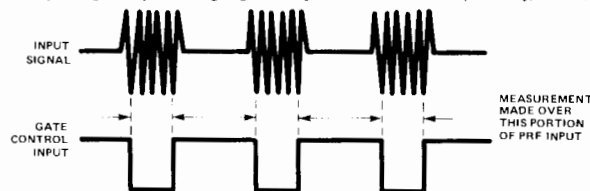

Figure 1. Frequency Averaging to Increase Resolution

External gating can also provide more versatility in time interval and totalize modes. For example, this capability allows the user to select only the desired portion of an input pulse train for a totalize measurement, as in figure 2. Time Interval measurements, such as those in figure 3, can also be made.

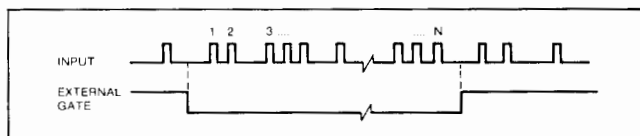

Figure 2. Selecting a Portion of a Pulse Train

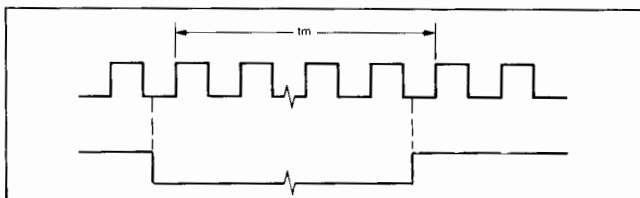

Figure 3. Using EXT GATE to Measure Tm



Ratio/A ± B Modes

Ratio and A ± B functions are included, being extremely useful for comparison between reference and test signals applied to the two mainframe inputs. Typical applications include bit error rate and synthesizer testing. Allowing high speed measurements, the frequency or bit rate of either channel can vary from dc to 500 MHz.

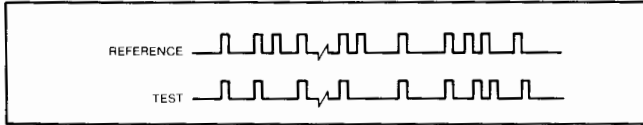

Figure 4. Comparison Measurements

In A-B mode, any difference between the total number of events accumulated in each channel is indicated by the 5345A display after the measurement is completed. In A+B mode, all transitions of a 1 gigabit NRZ signal can be measured by setting the "A" trigger slope to "+" and the "B" slope to "-".

Hewlett-Packard Interface Bus

Option 011 provides HP-IB control for all measurement functions, sample rate, gating and display position commands. Adding complete systems programmability, option 012 also includes remote slope and trigger level control.

5345A Condensed Specifications

Frequency/Period Measurements

Range: 0.00005 Hz to 500 MHz.

Accuracy: $\pm \frac{2 \times 10^{-9}}{\text{gate time}} \pm \text{trigger error} \pm \text{time base error}$.

Gate time: 1000 seconds to 100 nanoseconds in decade steps; <50 ns in MIN position.

Time Interval/Time Interval Average

Range: 10 ns to 20,000 s.

Minimum dead time: 10 ns

Trigger pulse width: 1 ns minimum width input at minimum voltage input.

Accuracy

Time interval: $\pm \text{trigger error} \pm 2 \text{ ns} \pm \text{time base error}$.

Time Interval Averaging

$\frac{\text{trigger error} \pm 2 \text{ ns}}{\sqrt{\text{intervals averaged}}} \pm 0.7 \text{ ns} \pm \text{time base accuracy}$

Not affected by harmonics of clock frequency.

Resolution

Time interval: 2 ns.

Time Interval Average

$\pm \frac{2 \text{ ns}}{\sqrt{\text{intervals averaged}}} \pm 2 \text{ picoseconds}$.

Ratio B/A

Range: both channels accept dc to 500 MHz.

Accuracy: $\pm \text{LSD} \pm \text{trigger error}$.

Start/Stop

Range: both inputs dc to 500 MHz.

Modes: A, A ± B determined by rear panel switch.

Scaling

Range: dc to 500 MHz.

Scaling factor: selectable by GATE TIME setting. Scaling factor equals GATE TIME setting/10⁻⁹ seconds.

Input: input signal through channel A.

Output: output frequency equals input frequency divided by scaling factor.

Input Channels A and B

Range: 0 to 500 MHz dc coupled 50 Ω and 1 MΩ; 4 MHz to 500 MHz ac coupled, 50 Ω; 200 Hz to 500 MHz ac coupled, 1 MΩ.

Impedance: selectable, 1 MΩ shunted by less than 30 pF or 50 Ω (nominal).

Sensitivity: X1, 20 mV rms sine wave and 60 mV peak-to-peak pulse. X10, 250 mV rms sine wave and 750 mV peak-to-peak pulse.

Dynamic range: 50 Ω & 1 MΩ: 20 mV to 250 mV rms sine wave (X1); 250 mV to 2.0 V rms (X10).

Trigger level: adjustable over ±1.3 V dc.

Output: rear panel BNC connectors bring out CHAN A TRIG LEVEL and CHAN B TRIG LEVEL for convenient DVM monitoring.

Common Input

Range: ac coupled 50 Ω, 4 MHz to 400 MHz; ac coupled 1 MΩ, 300 Hz to 400 MHz.

Impedance: 50 Ω remains 50 Ω; 1 MΩ becomes 500 kΩ shunted by <60 pF.

Sensitivity: 50 Ω: 40 mV rms; 1 MΩ: No change.

Dynamic range: 50 Ω: 40 mV to 500 mV rms (X1); 500 mV to 4 V rms (X10); 1 MΩ: No change.

Time Base

Standard High Stability Oven

Frequency: 10 MHz

Aging rate: <5 × 10⁻¹⁰ per day.

Short term: <1 × 10⁻¹¹ for 1 sec average.

Temperature: <7 × 10⁻⁹, 0°C to 55°C.

Opt 001

Frequency: 10 MHz

Aging rate: <3 × 10⁻⁷ per month.

Short term: <2 × 10⁻⁹ rms for 1 sec.

Temperature: <2 × 10⁻⁶, 25°C to 35°C.
<5 × 10⁻⁶, 0°C to 55°C.

Line voltage: <1 × 10⁻⁸, ±10% from nominal.

External frequency standard input: input voltage >1.0 V rms into 1 kΩ required from source of 1, 2, 2.5, 5 or 10 MHz ±5 × 10⁻⁸ (±5 × 10⁻⁶ for opt. 001).

Frequency standard output: >1 V rms into 50 Ω at 10.0 MHz sine wave.

General

Display: 11 digit LED display and sign. Annunciator displays msec to nsec, k to n, μHz to GHz. Decimal point is positioned with DISPLAY POSITION control or positioned after the first, second or third most significant digit if DISPLAY POSITION is in AUTO. Leading zeros are suppressed.

Overflow: asterisk is illuminated when display is overflowed.

Sample rate: continuously variable from <0.1 s. to >5 s. with front panel control. In HOLD position the last reading is maintained until the counter is reset.

External arm input: counter can be armed by a -1.0 V signal applied to the rear panel 50 Ω input.

External gate input: same conditions as for EXT ARM.

Gate output: >1 volt into 50 Ω.

Operating temperature: 0°C to 55°C.

Power requirements: 100/120/220/240 V rms +5% -10% 48 to 66 Hz, maximum power 250 VA.

Weight: 17 kg (37 lb).

Size: 132.6 H x 425 W x 495 mmD (5.22" x 16.75" x 19.5").

10590A Plug-In Adapter

The 10590A allows the user to interface any of the obsolete 5245 series of plug-ins (except the 5264A) to the 5345A counter.

Options and Accessories

001: Room Temperature Time Base

010: HP-IB Talk Only

011: HP-IB includes remote programming

012: HP-IB similar to OPT 011, but also includes slope and trigger level controls

908: Rack Flange Kit, number 5060-8740

10595A Board Extender Kit: For troubleshooting

K13-59992A: State machine tester to aid troubleshooting the arithmetic processor

K15-59992A: Standby power unit: Plug-in maintains oscillator operation without line voltage

Ordering Information

10590A Plug-In Adapter

5345A Plug-In Counter

ELECTRONIC COUNTERS

Frequency and Time Data Acquisition System

Model 5391A

- Capable of 100,000 measurements/second



5391A Frequency and Time Data Acquisition System

General

The HP5391A Frequency and Time Data Acquisition System combines the power of the HP5345A Universal Counter with the speed and storage capability of the HP5358A Measurement Storage Plug-In to allow you to make and store frequency or time measurements at rates as high as 100,000 measurements per second. The 5391A can help you characterize pulse width jitter by measuring and storing each pulse width and then computing statistical parameters such as min, max, mean, and standard deviation. Other application areas include nuclear time of flight studies, explosive testing and characterization, and frequency profile measurements.

The 5391A is a compact HP-IB system consisting of the 5345A Universal Counter with the 5358A Measurement Storage Plug-In, the 9825B Computing Controller, and a versatile software package providing utility application routines and diagnostic service routines.

Application Example

Frequencies, periods, ratios, and time intervals may be measured and stored by the 5391A. A typical application, shown in the figure, is to measure and store every pulse width in a burst of pulses:

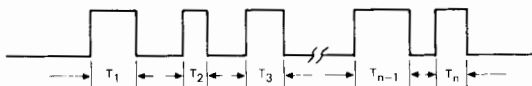

The 5345A counter makes a single shot time interval measurement (2 nanosecond resolution) for each pulse width. During the dead time between successive time intervals, the 5345A transfers the data to the 5358A Measurement Storage Plug-In. The time required for this transfer is $7 \mu\text{s} + 1 \mu\text{s}/\text{digit transferred}$. The graph plots transfer time required versus the time interval measured. If the dead time immediately following a measured time interval is greater than the required transfer time, the 5391A can make the measurement.

The 5391A, with its 9825B Controller, is capable of making and storing up to 1200 consecutive measurements for time intervals less than 2 milliseconds. Above 2 milliseconds, the 8K memory of the 5358A will limit the number, depending on the time interval.

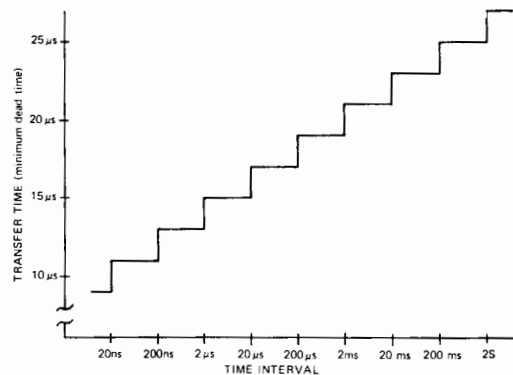

When the desired number of measurements in a run exceeds the maximum allowable, the maximum is taken and then stored as a block on the 9825B cassette. Subsequent blocks of measurements are taken and stored on cassette until the total desired number of measurements has been accumulated. The time required to transfer the measurement data from the 5358A to the 9825B and store it on cassette is on the order of seconds. During this time, no measurements can be made. The total number of measurements is program selectable from 1 to 9999.

Systems Options

325: Deletes 9825B Controller (as well as HP-IB Interface)

Ordering Information

5391A Basic System Includes:

- 5345A Option 011 Electronic Counter
- 5358A Measurement Storage Plug-in with 8K bytes of memory
- 9825B Computing Controller (Includes 32K Bytes of Memory, and all needed ROMs)
- 98034A HP-IB Interface
- System Software Cartridge
- System and Instrument Manuals

5391A Basic System

THE LAST DATE THAT ORDERS WILL BE ACCEPTED FOR THE 5391A SYSTEM IS NOVEMBER 30, 1983.



5355A

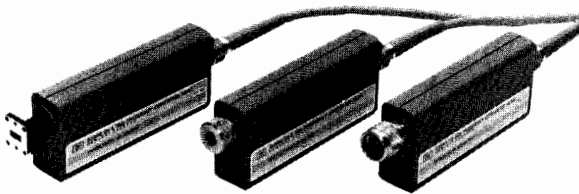

5356A/B/C

The 5355A automatic frequency converter plug in, together with the 5356A, 5356B, or 5356C frequency converter head, provides pulsed and CW frequency measurement capability to 18/26.5/40 GHz for the 5345A counter. A 0.4–1.5 GHz prescaled input offers pulsed and CW measurement for the lower microwave range even without one of the heads. The 5355A's internal microprocessor controls the measurement algorithm, computes the input microwave frequency, and displays it on the eleven digit 5345A display.

Superior pulsed RF performance is provided with selectable resolution to 100 Hz and better, with accuracy to 3 kHz. Internal pulse detection circuitry sets the counters gate for maximum resolution for any pulse width down to 75 ns. External gating allows samples as small as 20 nsec for performing dynamic frequency profiling of "CHIRPS" and other FM on the RF burst. This is also an excellent CW microwave counter, providing 1 Hz resolution in 1 second. Automatic amplitude discrimination and 60 MHz FM tolerance allows this counter to correctly measure carrier frequencies in the most difficult transmitted signals.

Microprocessor control provides automatic operation and diagnostic routines for quick easy failure isolation. The front panel keyboard provides user definable offsets including an $mx \pm b$ offset mode for receiver testing, where the local oscillator can be measured directly then multiplied by the appropriate harmonic number. Offsetting this by the receiver's IF allows the counter to conveniently display the tuned receiver frequency.

Ordering Information

5355A Automatic Frequency Converter Plug-In (HP-IB Standard)

5356A 18 GHz Frequency Converter Head

Option 001 High Pass Filter

Option 006 Limiter Input Protection (+39 dBm)

5356B 26.5 GHz Frequency Converter Head

Option 001 18–26.5 GHz Waveguide Input

Option 006 Limiter Input Protection (+39 dBm)

5356C 40 GHz Frequency Converter Head

Option 001 26.5–40 GHz Waveguide Input

- Fully automatic to 40 GHz
- Pulsed RF or CW measurement
- 60 ns minimum pulse width
- User definable offsets from front panel

Specifications

Input Specifications (pulse and CW mode)

	5356A	5356B	5356C
Frequency Range	1.5–18 GHz	1.5–26.5 GHz	1.5–40 GHz
Sensitivity: 1.5–12.4 GHz	–20 dBm	–20 dBm	–25 dBm
12.4–18 GHz	–15 dBm	–15 dBm	–20 dBm
18–26.5 GHz	—	–15 dBm	–20 dBm
26.5–34 GHz	—	—	–15 dBm
34–40 GHz	—	—	–10 dBm
Maximum Input 1.5–12.4 GHz	+5 dBm	+5 dBm	+5 dBm
12.4–18 GHz	+5 dBm	+5 dBm	+15 dBm
18–26.5 GHz	—	+5 dBm	+15 dBm
26.5–40 GHz	—	—	+15 dBm
Damage Level*	+25 dBm peak	+25 dBm peak	+25 dBm peak
Impedance	50 Ω NOMINAL	50 Ω NOMINAL	50 Ω NOMINAL
SWR: 1.5–10 GHz	<2:1 TYPICAL	<2:1 TYPICAL	<2:1 TYPICAL
10–18 GHz	<3:1 TYPICAL	<3:1 TYPICAL	<3:1 TYPICAL
18–26.5 GHz	—	—	<3:1 TYPICAL
26.5–34 GHz	—	—	<3:1 TYPICAL
34–40 GHz	—	—	<5:1 TYPICAL
Connector	N Male	SMA Male	APC 3.5 Male

* see Option 006 for higher damage protection.

CW Mode

	5356A/B/C Auto Mode	5356A/B/C Man Mode
FM Tolerance	15 MHz p-p (60 MHz p-p in special FM mode) rate: dc –10 MHz	80 MHz p-p rate: dc –10 MHz
AM Tolerance	Any modulation index provided the minimum signal level is greater than the counter sensitivity.	
Multiple Signal Discrimination	Automatic Amplitude Discrimination (AAD). Automatically measures largest signal provided signal is 8 dB (TYPICAL) greater than any signal within 500 MHz and 20 dB (TYPICAL) greater than any signal over the full frequency range of the head.	
Acquisition Time	5356A/B = 400 ms 5356C = 1.4 s	15 ms
LSD Displayed	1 Hz + 5345A Gate Time	
Resolution	$\pm 2 \times \text{LSD} \pm 10^{-10} \text{ rms} \times \text{FREQ}$	
Accuracy	$\pm 2 \times \text{LSD} \pm 1 \times 10^{-10} \text{ rms} \times \text{FREQ} \pm \text{time base error} \times \text{FREQ}$	

Pulse Mode

	5356A/B/C Input Auto Mode	5356A/B/C Input Man Mode
FM Tolerance	50 MHz p-p Chirp	80 MHz p-p Chirp
Acquisition Time	5356A/B/C Input Man Mode: 0 5356A/B Input Auto Mode: $100 \mu\text{s} \div (\text{EXT GATE WIDTH} \times \text{PRF}) + 650 \text{ ms for EXT GATE} \leq 100 \mu\text{s}$ $(2 \div \text{PRF}) + 650 \text{ ms for EXT GATE} > 100 \mu\text{s}$ 5356C Input Auto Mode: $(8 \div \text{PRF}) + 1.55\text{s} + 100 \mu\text{s} + (\text{EXT GATE WIDTH} \times \text{PRF})$ for EXT GATE $\leq 100 \mu\text{s}$. $(10 \div \text{PRF}) + 1.55 \text{ s for EXT GATE} > 100 \mu\text{s}$.	
Pulse Width Min:	100 ns	75 ns
Max:	20 ms	20 ms
Pulse Repetition Frequency Min:	50 Hz	50 Hz
Max:	2 MHz	2 MHz
Minimum ON/OFF RATIO	25 dB TYPICAL	
Maximum Video Feed-Through	15 mV p-p TYPICAL for rf burst rise and fall times >10 ns	
Minimum EXT GATE WIDTH	20 ns	
LSD Displayed	1 Hz + 5345A GATE TIME	
Resolution	$\pm 2 \times \text{LSD} \pm \text{rms jitter}^*$	
Accuracy	$\pm 2 \times \text{LSD} \pm \text{rms jitter}^* \pm \frac{.04}{\text{EXT GATE WIDTH}} \pm 3 \text{ KHz} \pm \text{Time base error} \times \text{FREQ}$	

* rms jitter = $100 \text{ Hz rms} + 1 \div \sqrt{(5345A \text{ GATE TIME}) (\text{EXT GATE WIDTH})}$

For EXT GATE signals generated by the 5355A, the EXT GATE WIDTH equals the input PULSE WIDTH minus 30 ns (TYPICAL) for the 5356A/B/C input and equals input PULSE width minus 65 ns (TYPICAL) for the 5355A 0.4–1.5 GHz input.



ELECTRONIC COUNTERS

Automatic Microwave Counters

Models 5342A & 5343A

- Microprocessor controlled
- Automatic measurement to 18 GHz/26.5 GHz
- Wide FM tolerance
- Simultaneous display of input level
- High sensitivity
- Automatic or manual operation

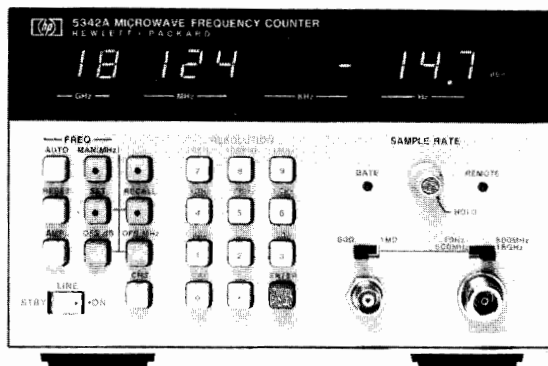

5342A



Description

The 5342A and 5343A Microwave Counters provide Automatic Frequency Measurement up to 18 or 26.5 GHz in highly portable packages. The 5342A extends to 24 GHz optionally.

The powerful and versatile microprocessor controlled keyboards can accomplish offset tasks as a standard feature as well as providing user interactive diagnostic information. The eleven-digit display is sectionalized for easy readout to one hertz resolution.

Both units utilize the Harmonic Heterodyne down conversion technique which combines the best performance features of the Heterodyne Converter and Transfer Oscillator Techniques. Now Wide FM Tolerance is achievable along with high input sensitivity and automatic amplitude discrimination. This allows the counter to automatically measure the largest signal present within the counters' spectrum while ignoring all others.

Amplitude Measurements (option 002) (5342A only)

Option 002 adds the ability to measure the input level of the incident sinewave signal. The instrument then displays this level in dBm. The eleven-digit LED display simultaneously presents frequency to 1 MHz resolution and amplitude to 0.1 dBm resolution. An added benefit from Option 002 is that dynamic range is extended so that frequency measurements to +22 dBm are accomplished. This extended dynamic range is also available without the amplitude measurement capability by ordering Option 003 (5342A only).

FM Tolerance

The ability to measure a carrier frequency while being frequency modulated has broad appeal in the communications industry and elsewhere. The 5342A can tolerate 50 MHz peak-to-peak worst case FM in the wide mode, or the normal mode with accompanying faster acquisition time can be selected which gives 20 MHz peak-to-peak worst case FM. The 5343A offers a selection of three (3) acquisition times including a 200 ms "fast" acquisition time with 6 MHz peak-to-peak worst case FM Tolerance.

Offset Functions

The power and versatility of the microprocessor controlled keyboard allows the user to perform offset functions by means of a few key strokes. Frequency values to 1 Hz resolution can be added to or subtracted from the measured frequency for IF offset application and also for monitoring variances about a given frequency. The 5343A also offers an $m \times \pm b$ mode for receiver testing where the measured local oscillator can be multiplied by the appropriate harmonic number. Adding the IF as an offset has the counter displaying the received frequency.

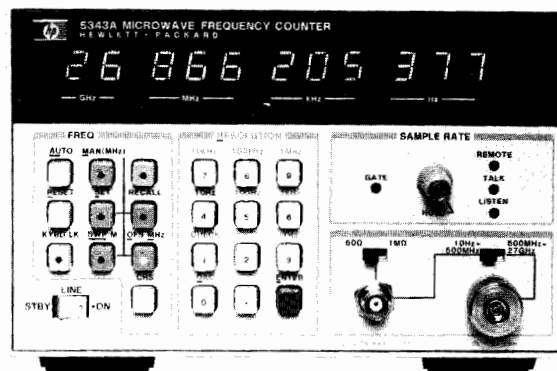

5343A



With Option 002 installed (5342A) this offset capability can be applied to the amplitude measurements. These offset values can be recalled to the display at any time for reviewing.

Digital-to-Analog Converter (option 004)

The ability to convert any three consecutive displayed digits (frequency or amplitude) into an analog voltage output on the rear panel is added by Option 004. This makes the monitoring of microwave oscillator frequency drift easy to make with only a strip chart recorder.

Microwave Limiter (option 006)

High input level protection is available with Option 006. It provides built-in microwave limiter protection for CW input signals up to +39 dBm (8 watts). This option is very useful for high input level environments where expensive input circuitry of the counter could be damaged.

HP Interface Bus For Systems Use (option 011)

The full power of HP-IB (IEEE 488) is brought to fruition with the addition of Option 011. Front and rear panel controls can now be remotely programmed and measurement results can be outputted to HP-IB-compatible instruments, calculators, or computers. This interface also can select a given frequency in the manual mode and reduce acquisition time to typically less than 80 msec.

5342A Specifications

Signal Input

Input 1

Frequency range: 5342A: 500 MHz to 18 GHz

5343A: 500 MHz to 26.5 GHz

Sensitivity: 5342A: 500 MHz to 12.4 GHz: -25 dBm

12.4 GHz to 18 GHz: -20 dBm

5343A: 500 MHz to 12.4 GHz: -33 dBm

12.4 GHz to 18. GHz: -28 dBm

18.0 GHz to 26.5 GHz: -23 dBm

Maximum input: +7 dBm (See OPT 002, 003 for higher levels)

Impedance: 50 ohms, nominal

Connector: 5342A: Precision Type N female

5343A: APC 3.5 male with collar

Damage level: +25 dBm, peak (See OPT 006 for +39 dBm protection)

Coupling: dc to load, ac to instrument.

SWR: < 2:1, 500 MHz-10 GHz

< 3:1, 10 GHz-18 GHz/26.5 GHz

FM tolerance: switch selectable (rear panel)

Wide: 50 MHz p-p worst case

Normal: 20 MHz p-p worst case

Narrow: (5343A only) 6 MHz p-p worst case

For Modulation Rates from dc to 10 MHz.

AM tolerance: any modulation index provided the minimum signal level is not less than the sensitivity specification.

Automatic amplitude discrimination: automatically measures the largest of all signals present, providing that signal is 6 dB above any signal within 500 MHz; 20 dB above any signal, 500 MHz–18 GHz/26.5.

Modes of Operation

Automatic: counter automatically acquires and displays highest level signal within sensitivity range.

Manual: center frequency entered to within ± 40 MHz of true value.

Acquisition Time

Automatic Mode

Narrow FM 200 ms worst case (5343A only)

Normal FM 530 ms worst case

Wide FM 2.4 s worst case

Manual mode: 80 ms after frequency entered

Input 2

Frequency range: 10 Hz to 520 MHz direct count.

Sensitivity: 50 Ω : 10 Hz to 520 MHz: 25 mV rms. 1 M Ω : 10 Hz to 25 MHz: 50 mV rms.

Impedance: selectable 1 M Ω , <50 pF or 50 Ω nominal.

Coupling: ac.

Connector: type BNC female.

Maximum input 50 Ω : 3.5 V rms (+24 dBm) or 5 V DC, fuse protected

1 M Ω : 200 V DC + 5 V rms

Time Base

Crystal frequency: 10 MHz.

Stability

Aging rate: < 1×10^{-7} /month

Temperature: < $\pm 1 \times 10^{-6}$ over the range 0°C to 50°C

Short term: < 1×10^{-9} for 1 second averaging time.

Line variation: < $\pm 1 \times 10^{-7}$ for 10% change from nominal.

Output frequency: 10 MHz, ≥ 2.4 V square wave (TTL compatible) 1.5 p-p V into 50 Ω available from rear panel BNC.

External time base: requires 10 MHz, 3.0 V p-p sine wave or square wave into 1 K Ω via rear panel BNC connector. Switch selects either internal or external time base.

Optional Time Base (option 001)

Crystal frequency: 10 MHz.

Stability

Aging rate: < 5×10^{-10} /day after 24-hour warmup

Temperature: < 7×10^{-9} over the range 0°C to 50°C

Short term: < 1×10^{-10} for 1 second averaging time

Line variation: < 1×10^{-10} for 10% change from nominal

Warm-up: < 5×10^{-9} of final value 20 minutes after turn-on, at 25°C.

Amplitude Measurement (opt 002) (5342A only)

Input 1

Frequency range: 500 MHz–18 GHz.

Dynamic range (frequency and level)

–22 dBm to +22 dBm 500 MHz to 12.4 GHz

–15 dBm to +22 dBm 12.4 GHz to 18 GHz

Maximum operating level: +22 dBm

Damage level: +25 dBm, peak

Resolution: 0.1 dBm

Accuracy: ± 1.5 dB (excluding mismatch uncertainty).

SWR: <2:1 (amplitude measurement).

<5:1 (frequency measurement).

Measurement time: 100 ms + frequency measurement time.

Display: simultaneously displays frequency to 1 MHz resolution and level. (Option 011 provides full frequency resolution on HP-IB).

Input 2 (50 Ω impedance only)

Frequency range: 10 MHz–520 MHz.

Dynamic range (frequency and level): –17 dBm to +20 dBm

Damage level: +24 dBm.

Accuracy: ± 1.5 dB (excluding mismatch uncertainty).

SWR: <1.8:1.

Measurement time: 100 ms + frequency measurement time.

Display: simultaneously displays frequency and input level.

Extended Dynamic Range (opt 003) (5342A only)

Frequency range: 500 MHz to 18 GHz.

Sensitivity: 500 MHz to 12.4 GHz: –22 dBm

12.4 GHz to 18 GHz: –15 dBm

Maximum operating level: +22 dBm

Dynamic range: 500 MHz to 12.4 GHz: 44 dB

12.4 GHz to 18 GHz: 37 dB

Damage level: +25 dBm, peak

SWR: <5:1

Microwave Limiter (option 006)

Input 1

Frequency range: 5342A: 500 MHz – 18 GHz

5343A: 500 MHz – 26.5 GHz

Sensitivity: 5342A: 500 MHz – 12.4 GHz: –21 dBm

12.4 GHz – 18 GHz: –15 dBm

5343A: 500 MHz – 12.4 GHz: –30 dBm

12.4 GHz – 18 GHz: –24 dBm

18 GHz – 26.5 GHz: –18 dBm

Maximum operating level: +7 dBm

Damage level: 500 MHz – 6 GHz: +39 dBm (8W)

6 GHz – 18 GHz: +36 dBm (4W)

(5343A only) 18 GHz – 26.5 GHz: +34.8 dBm (3W)

SWR: 2.5:1, 500 MHz – 10 GHz

3.5:1, 10 GHz – 18 GHz/26.5 GHz

Note: Option 006 is incompatible with Option 002, Option 003, and Option 005 for 5342A. Please consult factory special to combine Options 005 and 006.

General

Accuracy: ± 1 count \pm time base error.

Resolution: front panel push buttons select 1 Hz to 1 MHz

Display: 11 digit LED display, sectionalized to read GHz, MHz, kHz, and Hz.

Self-check: selected from front panel pushbuttons displays 75 MHz for resolution chosen.

Frequency offset: selected from front panel pushbuttons. Displayed frequency is offset by entered value to 1 Hz resolution.

Frequency multiply: (5343A only) (mx \pm b) measured data is multiplied by any integer up to 99. Offset can then be added or subtracted. Front panel selectable.

Totalize (5343A only): input 2 can totalize at rates up to 520 MHz. Readout on the fly is controlled by front panel or HP-IB.

Sample rate: variable from less than 20 ms between measurements to HOLD which holds display indefinitely.

IF out: rear panel BNC connector provides 25 MHz to 125 MHz output of down-converted microwave signal.

Power requirements: 100/120/220/240 V rms, +5%, –10%, 48–66 Hz; 100 VA max.

Weight: net 9.1 kg (20 lb.). Shipping 12.7 kg (28 lb.).

Size: 133 mm H x 213 W x 498 mm D (5.25" x 8.38" x 19.6").

Options and Accessories

001: High Stability Time Base

002: Amplitude Measurement (5342A Only)

003: Extended Dynamic Range (5342A Only)

004: Digital-To-Analog Converter

005: Frequency Extension to 24 GHz (5342A Only)

006: Limiter Input Protection (+39 dBm)

011: Digital Input/Output (HP-IB) (Cable Not Incl)

908: Rack Mounting Adapter Kit

K70-59992A: Rack Mounting Adapter Kit With Slot

For access to front connectors from rear.

10842A: Extender Board Kit

5342A Frequency Counter

5343A Frequency Counter



ELECTRONIC COUNTERS

Microwave Source Synchronizer

Model 5344S

- Convenient CW lock
- High performance microwave counter
- Narrow band locked sweeps
- Wideband lock and roll

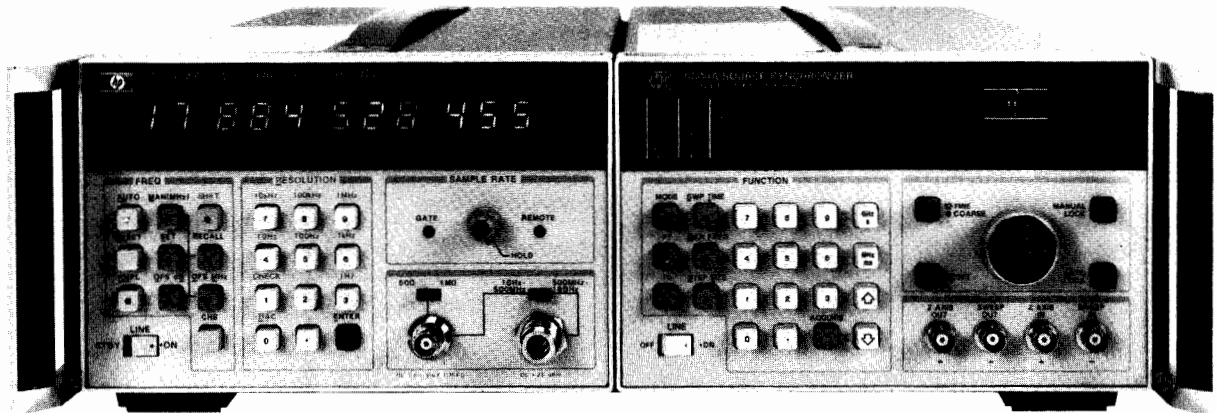

Description

The 5344S Microwave Source Synchronizer phase locks your microwave signal to a high stability quartz oscillator in the 5344S. This greatly increases the frequency accuracy and repeatability of the microwave source in CW or swept operation. The long-term frequency stability (5×10^{-10} /day) of your source now becomes comparable to that of a microwave synthesizer but at a much lower cost. The 5344S is a full rack system consisting of the 5344A Source Synchronizer and the 5342A 18 GHz Microwave Counter with an Option 001 High Stability Timebase and Option 011 HP-IB Interface (HP's implementation of IEEE Standard 488). These two half rack instruments are mechanically and electrically integrated at the factory.

For applications requiring direct phase locked frequencies up to 26.5 GHz, the 5344S Option 043 is available which replaces the 5342A with the 5343A 26.5 GHz Microwave Counter.

5344S Specifications

Lock Input

Frequency coverage: 500 MHz–18 GHz
500 MHz–26.5 GHz (5344S Option 043)

Resolution: 1 Hz

Long-term stability: equal to timebase in counter

	Standard (5342A)	Option 043 (5343A)
Minimum Lock Level		
500 MHz–12.4 GHz	–22 dBm	–30 dBm
12.4 GHz–18.0 GHz	–19 dBm	–25 dBm
18.0 GHz–26.5 GHz	—	–20 dBm

Lock time (TYPICAL): dependent on source. Typical times with 8350A/83592A source

Manual Lock: 900 ms Apply to CW or LOCK/ROLL modes.
Auto Lock: 1.5 s For CF/ Δ F or START/STOP add 300 ms.

Option 043: all lock times reduced by 400 ms

Accuracy (CW): equal to counter accuracy

Capture Range (manual mode)

CW or LOCK/ROLL (start frequency): ± 25 MHz for sources with FM sensitivity greater or equal to 5 MHz/V. Five volts \times FM sensitivity for sources less than 5 MHz/V sensitivity.

FM output connector: rear panel BNC female

FM output drive: ± 10 V in series with 250 ohms

Polarity: automatic selection

Operating Modes

CW: Manual Lock—Source is manually tuned to within capture range of desired frequency

Auto Lock—Source is tuned automatically by the 5344S via the HP-IB to bring it into lock.

CW/ Δ F sweep (manual lock or auto lock): performs a phase continuous locked sweep from $CF - \frac{1}{2}\Delta F$ to $CF + \frac{1}{2}\Delta F$ in a sweep time defined by the user. Sweeps up to 40 MHz are available.

START/STOP sweep (manual lock or auto lock): performs a phase continuous locked sweep from START frequency to STOP frequency over a sweep time defined by the user. Sweeps up to 40 MHz are available.

Accuracy—CF/ Δ F and START/STOP modes

Start or Stop Frequencies: 1 kHz TYPICAL

Linearity: $\pm 0.05\%$ of sweep with respect to Sweep Out voltage (TYPICAL)

Resolution: 1 Hz for CF/ Δ F, START, and STOP frequencies

Sweep time: available in CF/ Δ F and START/STOP modes. Continuously adjustable from 10 ms to 100 s.

Marker frequencies: available in CF/ Δ F and START/STOP modes. Up to four frequency markers are settable across the sweep band.

LOCK/ROLL (manual lock or auto lock): sweep is phase-locked by the 5344S to a precise start frequency and then control is transferred to the sweeper to complete the sweep. The source determines sweep time, marker frequencies, and stop frequency.

General

Microwave counter specifications: refer to 5342A or 5343A data.

Operating temperature: 0°C to 50°C

Power requirements: 100/120/220/240 V rms, +5%, –10% 48–66 Hz; 125 VA max (5344A) plus 100 VA Max (5342A)

Size: 133 mm H x 426 mm W x 498 mm D (5¼" x 16¾" x 19½")

Weight: net 18.7 kg (41 lbs.). Shipping 25.9 kg (57 lbs.)

Front handles: supplied with the instrument.

Ordering Information

Option 043 26.5 GHz operation (5343A microwave counter replaces the 5342A in the system)

Option 142 Deletes 5342A microwave counter

Option 908 Rack mounting flange kit for use upon removal of supplied front handles

Option 913 Rack mounting flange kit for use with supplied front handles

5344S Microwave Source Synchronizer (18 GHz)

ELECTRONIC COUNTERS

Automatic Microwave Counter

Model 5340A

287



- Single input 10 Hz to 18 GHz
- Automatic amplitude discrimination
- High sensitivity -35 dBm

- Optional extension to 23 GHz
- High AM and FM tolerance
- Exceptional reliability



5340A



The 5340A Frequency Counter provides an easily used, versatile instrument for the direct measurement of frequencies from 10 Hz through 18 GHz via a single input connector. Utilizing microwave samplers incorporated in advanced phase-lock loops, this counter excels in many important specification parameters. It is therefore suited to a wide range of applications.

The exceptional sensitivity of this instrument enhances measurement in the microwave field, where signals are commonly low level and many times are connected via directional couplers or lossy devices. Wide tolerance of AM, FM, and residual noise insure accurate measurement of microwave carrier frequencies despite the presence of these deviations. Automatic amplitude discrimination allows the 5340A to choose the largest signal in a spectrum (250 MHz to 18 GHz) and measure only that signal's frequency, ignoring all others.

Access to the HP Interface Bus via Option 011 provides a particularly flexible system interface. The ability to program octave range via this input allows reduction of acquisition time to typically less than 40 ms. AN 181-1 describes the use of a calculator-controlled measurement system built around the HP Interface Bus for microwave component testing.

5340A Specifications

Signal Input

Input 1

Range: 10 Hz to 18 GHz.

Symmetry: sine wave or square wave input (40% duty factor, worst case).

Sensitivity: -30 dBm, 10 Hz to 500 MHz; -35 dBm, 500 MHz to 10 GHz; -25 dBm, 10 to 18 GHz.

Dynamic range: 37 dB, 10 Hz to 500 MHz; 42 dB, 500 MHz to 10 GHz; 32 dB, 10 GHz to 18 GHz.

Impedance: 50 Ω .

VSWR: <2:1, 10 Hz-12.4 GHz; <3:1, 12.4-18 GHz.

Connector: precision Type N.

Coupling: dc to load, ac to instrument.

Damage level: +30 dBm. Total power (ac + dc) not to exceed 1 watt. See Option 006 for up to +39 dBm protection.

Acquisition time: <150 ms mean typical.

Input 2

Range: 10 Hz-250 MHz direct count.

Sensitivity: 50 mV rms, 150 mV p-p pulses to 0.1% duty factor; minimum pulse width 2 ns.

Impedance: 1 M Ω shunted by <25 pF.

Connector: type BNC female.

Coupling: ac

Maximum input: 200 V rms, 10 Hz to 100 Hz; 20 V rms, 100 Hz to 100 kHz; 2 V rms, 100 kHz to 250 MHz.

Automatic amplitude discrimination: automatically selects the strongest of all signals present (within 250 MHz to 18 GHz phase-lock range), providing signal level is: 6 dB above any signal within 200 MHz; 10 dB above any signal within 500 MHz; 20 dB above any signal, 250 MHz-18 GHz.

Maximum AM modulation: any modulation index as long as the minimum voltage of the signal is not less than the sensitivity specification.

Time Base

Crystal frequency: 10 MHz.

Stability

Aging rate: <3 $\times 10^{-7}$ per month.

Short term: <5 $\times 10^{-10}$ rms for 1 second averaging time.

Temperature: < $\pm 2 \times 10^{-6}$ over the range of 0°C to 50°C.

Line variation: < $\pm 1 \times 10^{-7}$ for 10% line variation from nominal.

Output frequency: 10 MHz, ≥ 2.4 V square wave (TTL compatible) available from rear panel BNC.

External time base: requires 10 MHz approximately 1.5 V p-p sine wave or square wave into 1 k Ω via rear panel BNC. Switch selects either internal or external time base.

Optional time base (opt 001) aging rate: <5 $\times 10^{-10}$ per day after 24 hour warm-up for less than 24 hour off-time.

General

Accuracy: ± 1 count \pm time base error.

Resolution: front panel switch selects 1 MHz, 100 kHz, 10 kHz, 1 kHz, 100 Hz, 10 Hz, or 1 Hz.

Display: eight digit LED with positioned decimal point and appropriate measurement units of kHz, MHz, or GHz.

Self check: counts and displays 10 MHz for resolution chosen.

Sample rate: controls time between measurements. Continuously adjustable from 50 ms typical to 5 seconds. HOLD position holds display indefinitely. RESET button resets display to zero and activates a new measurement.

Operating temperature: 0°C to 50°C.

Power: 115 V or 230 V +5%, -10%, 48-66 Hz, 100 VA.

Weight: net, 11.3 kg (25 lb). Shipping, 14.1 kg (31 lb).

Size: 88.2 H x 425 W x 467 mm D (3.47" x 16.75" x 18.39").

Options

001: High Stability Time Base

002: Rear Panel Connectors

005: Frequency Extension to 23 GHz

006: Limiter Input Protection (+39 dBm)

011: Remote Programming-Digital Output (HP-IB).

908: Rack Flange Kit

5340A Frequency Counter

ELECTRONIC COUNTERS

Universal Time Interval Counter

Model 5370B

- 20 ps single shot time interval counter
- Statistics
- Automatic calibration of systematic errors
- Positive or negative time intervals
- Frequency and period to 100 MHz



5370B

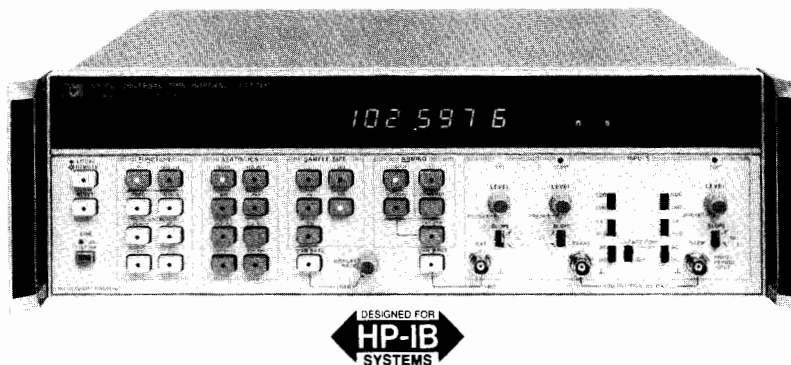

The 5370B Universal Time Interval Counter is designed for easy, very accurate testing of components, radar and laser ranging, and nuclear systems, as well as having applications in digital communications, IC testing, and calibration. Its microprocessor-based design adds features such as statistics that let the user characterize jitter. Positive or negative time interval measurements, useful for differential measurements, and display of trigger levels are also among the features found on the 5370B.

In addition to having a measurement scheme which resolves single-shot time interval measurements to ± 20 ps, this counter specs a full 4V pp dynamic range with -2 volts to $+2$ volts trigger level range. Other standard features found on the instrument include automatic computation of statistical data on pulse trains and easy operation, and the instrument will also measure waveform period and frequency to 100 MHz with up to 11 digits in 1 second of measurement time.

All major front panel controls including trigger levels are programmable by means of the Hewlett-Packard Interface Bus (HP-IB), which is another standard feature of this instrument.

Functions

TI: time interval function measures time difference from the START to the STOP channel. In the \pm TI mode, the counter will measure the time from the first event in either channel to the first event in the other channel. The microprocessor affixes a negative sign to the display if the stop channel event occurred first.

The negative time feature allows applications like differential phase measurement between two waveforms to be continuously monitored even though the phase changes from a positive to a negative drift. Statistical functions are available in both TI modes.

Trig Lvl: measures the trigger levels of START and STOP channels and displays both levels simultaneously with 10 mV resolution. Additional equipment like an oscilloscope or DVM is not required.

Freq: measures the frequency of the STOP channel signal by taking the reciprocal of a period average. Both timed gates and single period gates are available. In the single period mode, resolution may be improved by using a larger sample size. Statistics are available in the single period mode.

The exceptionally high resolution (11-12 digits per second) of the 5370B makes the instrument ideal for directly measuring the drift of oscillators and other applications requiring exceptionally high frequency resolution.

Period: measures the period average of STOP channel events. Statistics are available in the single period mode.

Statistics

Statistical functions allow much more complete characterization of time intervals. In addition to the mean, both the max and min within a selected sample size are available and also the standard deviation. In many cases, these parameters are of more interest than the mean. For example, in a digital communications system, the limits of pulse jitter as described by the max and min could be of primary interest. For a normal distribution of jitter, the standard deviation gives the rms jitter directly.

Sample size: push-button selectable to 1,100, 1K, 10K, and 100K samples.

Mean: displays the mean estimate which is the average for the selected sample size.

Std dev: displays a standard deviation estimate for the selected sample size.

Min: displays the minimum time interval measured within the selected sample size.

Max: displays the maximum time interval measured within the selected sample size.

Arming

Extremely flexible arming greatly extends the usefulness of the 5370B into new applications. "Hold-off" features allow complex pulse trains to be measured by preventing "stop channel" arming until the removal of an external "gating" signal. An example could be the measurement of time from a radar or laser send pulse to the return pulse, where depending on the range of the object, several return pulses may occur before the return pulse of interest.

Other methods of arming allow the counter to be externally gated by an input waveform which very precisely controls both measurement duration and the time position at which the measurement occurs. Applications are in the frequency profiling of VCO's, pulsed rf bursts, or sweep linearity investigations.

The following modes of arming are available:

- +TI
- Internally armed – no hold-off
- Externally armed – no hold-off
- Externally armed – external hold-off
- \pm TI
- External arming
- Internal arming



Programming

Major controls are programmable via the HP-IB, making the 5370B a versatile, hi-performance unit for systems applications.

Data Output Rate

- 1) HP-IB: 10-20 readings per second.
Dead time between measurements within a sample is 330 μ s.
- 2) Fast Binary: 6 kHz
Dead time between measurements is 165 μ s.

5370B Specifications

Sensitivity: 100 mV p-p, 35 mV rms sine wave \times attenuator setting.

Impedance: selectable 1 M Ω //45 pF or 50 Ω nominal.

Trigger level: -2 V to +2 V, adjustable; 10 mV displayed resolution.

Trigger slope: independent selection of + or - slope.

Attenuators: $\times 1$ and $\times 10$ nominal.

Dynamic Range (preset)

- 50 Ω $\times 1$:** 100 mV to 4 V p-p pulse; **$\times 10$:** 1 V to 7 V p-p pulse
1 M Ω $\times 1$: 100 mV to 4 V p-p pulse; **$\times 10$:** 1 V to 10 V p-p pulse
 Dynamic range for rms sine wave is one-third of the above values.

Signal Operating Range

- 50 Ω $\times 1$:** -4 V to +4 V; **$\times 10$:** -7 V to 7 V
1 M Ω $\times 1$: -4 V to +4 V; **$\times 10$:** -25 V to 10 V

Coupling: ac or dc switch selectable.

Minimum pulse width: 5 ns

Maximum Input

- 50 Ω $\times 1$:** ± 7 V dc
 7 V rms below 5 MHz
 3.5 V rms (+24 dBm) above 5 MHz
 $\times 10$: ± 7 V dc, 7 V rms (+30 dBm)
1 M Ω $\times 1$: ± 350 V dc
 250 V rms to 20 kHz decreasing to 3.5 V rms
 above 5 MHz
 $\times 10$: ± 350 V
 250 V rms to 20 kHz decreasing to 35 V rms
 above 5 MHz

Common Input

All specifications are the same as for separate operation with the following differences:

Impedance: 1 M Ω becomes 500 k Ω shunted by <80 pF. 50 Ω same as in separate.

Sensitivity (preset)

- 50 Ω $\times 1$:** 200 mV p-p, 70 mV rms; **$\times 10$:** 2 V p-p, 700 mV rms
1 M Ω : same as in separate

Dynamic Range (preset)

- 50 Ω $\times 1$:** 200 mV to 5 V p-p pulse; **$\times 10$:** 2 V to 5 V p-p pulse
1 M Ω : same as in separate

Maximum Input

- 50 Ω ± 5 V dc or 5 V rms
 1 M Ω same as in separate

Attenuators: becomes $\times 2$ and $\times 20$ for 50 Ω

Time Interval Measurements

Time Interval Range

- \pm **Mode:** -10 seconds to +10 seconds including 0 seconds
 + **Only mode:** 10 ns to 10 seconds
Sample size. (N): 1, 100, 1000, 10,000, 100,000
 1 to 16777215 via HP-IB

Statistics: Mean, Standard Deviation, Maximum, Minimum. Time between measurements 330 μ s; minimum rise time 1 ns

Least significant digit displayed: 20 ps / \sqrt{N}

Resolution

(± 100 ps rms \pm Start Trigger Error \pm Stop Trigger Error) $\div \sqrt{N}$

Accuracy: \pm Resolution \pm Time Base Error \times Time Interval
 \pm Trigger Level Timing Error ± 1 ns Systematic

Trigger Error =

$$\frac{\sqrt{(150 \mu\text{V})^2 + e_n^2}}{\text{Input voltage slew rate (V/s) at trigger point}} \text{ secs rms}$$

where 150 μ V is the typical rms input amplifier noise on the 5370B and e_n is the rms noise of the input signal for a 500 MHz bandwidth.

Trigger Level Timing Error =

$$25 \text{ mV} \div \text{input voltage slew rate (V/s) at trigger point}$$

Frequency Measurements

Frequency range: 0.1 Hz to 100 MHz

Timed Gates

Internal gate time: 1 period, 0.01, 0.1, 1 seconds

Least significant digit displayed: $\frac{20 \text{ ps}}{\text{Gate Time}} \times \text{FREQ}$

Resolution

$$\pm \frac{100 \text{ ps}}{\text{Gate Time}} \times \text{FREQ} \pm 1.4 \frac{\text{Trigger Error}}{\text{Gate Time}} \times \text{FREQ}$$

Accuracy: \pm Resolution \pm (Time Base Error) \times FREQ
 \pm (100 ps Systematic \div Gate Time) \times FREQ

Statistics: Mean

Sample Mode (single period)

Sample size: same as Time Interval

Least significant digit displayed: 20 ps / $\sqrt{N} \times \text{FREQ}$

Resolution

$$\pm \frac{100 \text{ ps}}{\text{Gate Time}} \times \text{FREQ} \pm 1.4 \frac{\text{Trigger Error}}{\text{Period} \sqrt{N}} \times \text{FREQ}$$

Accuracy: \pm Resolution \pm (Time Base Error) \times FREQ
 \pm (100 ps Systematic \div Period) \times FREQ

Statistics: Mean, Standard Deviation, Maximum, Minimum.

External Gate

Gate input: 20 ns to 10 seconds

Resolution and accuracy estimates may be made with the same specifications as Timed Gates above.

Period Measurements

Period range: 10 ns to 10 seconds

Timed Gates

Internal gate time: 1 period, 0.01, 0.1, 1 seconds

Least significant digit displayed: $\frac{20 \text{ ps}}{\text{Gate Time}} \times \text{PERIOD}$

Resolution

$$\pm \frac{100 \text{ ps}}{\text{Gate Time}} \times \text{PERIOD} \pm 1.4 \frac{\text{Trigger Error}}{\text{Gate Time}} \times \text{PERIOD}$$

Accuracy: \pm Resolution \pm Time Base Error \times PERIOD
 \pm (100 ps Systematic \div Gate Time) \times PERIOD

Sample Mode (single period)

Sample size (N): same as Time Interval.

Least significant digit displayed: 20 ps / \sqrt{N}

Resolution: ± 100 ps / $\sqrt{N} \pm 1.4$ Trigger Error / \sqrt{N}

Accuracy: \pm Resolution \pm Time Base Error \times PERIOD
 ± 100 ps Systematic

Statistics: Mean, Standard Deviation, Maximum Minimum

External Gate

Gate input: 20 ns to 10 seconds

Resolution and accuracy estimates may be made with the same specifications as timed measurements above.

Time Base

High Stability Oven Oscillator

Frequency: 10 MHz

Aging: $< 5 \times 10^{-10}$ per day

Temperature: $< 2.5 \times 10^{-9}$, 0 $^\circ$ C to 50 $^\circ$ C

General

Display: 16 digits, suppressed leading zeros.

Size: 133 H \times 426 W \times 521 mm D (5.25" \times 16.75" \times 20.5").

Weight: 32 lbs.

Power requirements: 100, 120, 220, or 240 V ac $\pm 5\%$ -10%, 48 to 66 Hz, less than 250 VA.

Front handles: supplied with instrument.

Ordering Information

Option 908: Rack Flange Kit for use without handles

Option 913: Rack Flange Kit for use with supplied front handles

10870A: Service Kit Accessory

5370B Universal Time Interval Counter

ELECTRONIC COUNTERS

Time Interval Probes and Preamp

Models 5363B & 10855A & 10856A

- Precise trigger level setting
- Wide input dynamic range

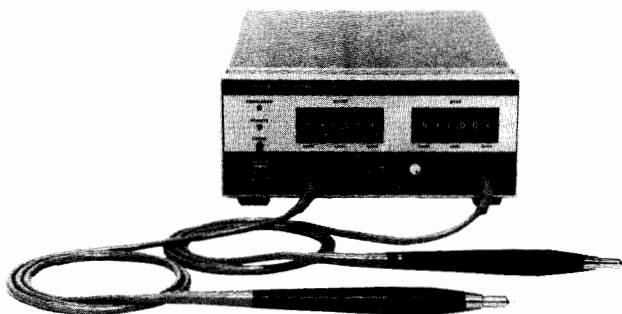

5363B



5363B Time Interval Probes Enhanced Counter Measurements

The 5363B provides the necessary input signal conditioning to allow a universal counter to make highly accurate and repeatable time interval measurements. Counters such as the 5345A, 5370B, 5335A, 5334A, and 5328A when teamed-up with the 5363B can now make more accurate rise time, fall time, slew rate, propagation delay, and other complex measurements.

Wide Dynamic Range, Fine Trigger Level Settability

Greatly improved dynamic range allows the trigger point to be selected in 10 mV increments from -9.99 V to +9.99 V.

Minimized Circuit Loading

High impedance, low capacitance active probes minimize circuit loading and pulse distortion. Each probe contains two measurement channels, start and stop, so timing measurements on one waveform are possible. As example, the input/output rise (propagation delay) of a device can be measured between the probes.

Eliminate Systematic Timing Errors

Delays through probes, cables and inherent differential delays between a counter's input channels limit the absolute accuracy of time interval measurements

A calibration procedure using the 5363B can equalize such systematic delays to set the counter to read 0.0 ns. This is possible with counters that can measure down to 0 ns like the 5370B and the 5335A. For counters with a minimum time interval specification (5345A and 5328A Option 040 and 041 have 10 ns minimum capability), the 5363B can add a fixed offset of 10 ns to permit measurements of zero time interval.

5363B Specifications

Operating range: ±10 V

Minimum input voltage: ±100 mV about trigger point

Damage level: ±30 V

Voltage resolution: 10 mV

Impedance: 1 M ohm shunted by <20 pF

Effective bandwidth: 350 MHz (1 ns rise time)

Minimum pulse width: 5 ns at ±100 mV about trigger point

Output to counter: separate start/stop outputs; -0.5 V to +0.5 V into 50 ohm, slew rate through zero volts exceeds 0.25 V/ns

Delay compensation range: 2 ns adjustable about 0 ns to 10 ns

Power: 100, 120, 220, 240 VAC (+5-10%), 48-440 Hz; 40 VA max

Weight: net 3.0 kg (6.5 lb). Shipping 5.5 kg (12 lb)

Dimensions: 88.1 H x 212 W x 248 mm D (3.5" x 8.4" x 11.6").

Absolute Accuracy

$$\pm 1 \text{ ns} \pm \frac{\text{START TLA} + \text{START NTE}}{\text{START slew rate}} \pm \frac{\text{STOP TLE} + \text{STOP NTE}}{\text{STOP slew rate}}$$

where TLA denotes trigger accuracy and NTE denotes noise trigger error.

Noise trigger error: $\sqrt{(125 \mu\text{V})^2 + e_n^2}$ volts where 125 μV is the typical input noise on the 5363B and e_n is the input signal noise for a 350 MHz bandwidth.

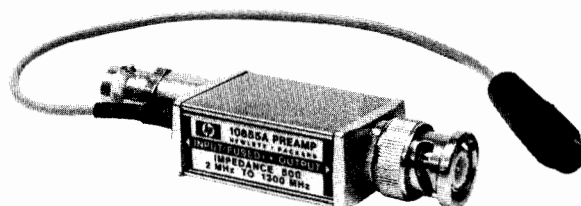

10855A

10855A 2-1300 MHz Preamp

The 10855A Preamp provides a minimum of 22 dB gain from 2 MHz to 1300 MHz to enhance measurements of very low-level signals. The ±1.5 dB flat response reduces distortion in non-sinusoidal waveforms. The 10855A operates conveniently with a variety of HP measuring instruments having probe power outlets, or will work with the 1122A Probe Power Supply. The 5334A/5335A Option 030, 5328A Option 031, and 5305B counters all measure frequency to 1300 MHz and are compatible for use with the 10855A.

10855A Specifications

Frequency range: 2 MHz-1300 MHz

Gain (minimum): 22 dB; 24 dB typical

Gain flatness across full frequency range: ±1.5 dB

Noise figure: <8.5 dB typical

Output power for 1 dB gain compression: 0 dBm

Harmonic distortion: -30 dB for -15 dBm output, typical

Output for <-66 dB harmonic distortion: -25 dBm, typical

VSWR: input and output, <2.2

Impedance: 50 Ω nominal

Reverse isolation: >45 dB

Maximum input: 3.5 V rms (+24 dBm), fuse protected

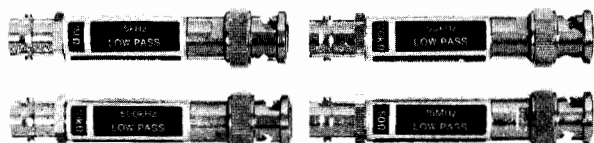

10856A

10856A Low Pass Filter Kit

The four low pass filters of the 10856A filter kit are recommended for use with any HP frequency counter to reduce high frequency noise or unwanted signals that cause frequency or period measurement errors. Further applications for the kit include reducing noise (trace fuzz) in oscilloscope and spectrum analyzer displays.

10856A Specifications

Cut Off Frequency (NOMINAL)	5 KHz	50 KHz	500 KHz	15 MHz
Input Impedance (NOMINAL)	1 M Ω	100 k Ω	10 k Ω	50 Ω
Signal Rejection, 100 MHz to 500 MHz	>40 dB	>40 dB	>40 dB	>20 dB

Roll-off: 20 dB per decade.

Attenuation: $\times 2$, reduces signal voltage by a factor of 2.

Output impedance: for use with 1 M Ω input instruments.

Accessories Available

10821A Probe Accessory Kit including 2 of each of the following: 10229A Hook Tip; 10218A BNC to Probe Adapter; 10100C 50 ohm Feedthrough termination; 1250-0655 BNC Tee to Probe Adapter; and 8710-0661 HP Probe tips (extra).

5363B Time Interval Probes

10855A 2-1200 MHz Preamp

10856A Low Pass Filter Kit



ELECTRONIC COUNTERS

200 MHz Universal Counter

Model 5335A

291



- A high performance 200 MHz/2 ns Universal Counter
- Built-in automatic rise time, duty cycle, pulse width, slew rate and phase measurements
- Unique advanced automatic triggering capabilities
- HP-IB plus math and statistics functions standard



5335A



Remarkable Automatic Measurement Power

The HP-5335A is an advanced universal counter with automatic measurement power built-in. Designed either for bench or systems applications, the counter has 16 front-panel measurement functions, plus four "phantom" functions. All automatically selected by push button or by HP-IB. These twenty functions, plus greatly expanded arming and triggering capability make the 5335A a most powerful universal counter. In addition, math and statistics features, matched Channel A and B input amplifiers, and HP-IB, are all included in the standard unit, making the 5335A easily the most advanced universal counter available at its price.

The 5335A has all the measurement functions normally found in a universal counter. Plus, it has automatic operation. Beyond these features, it possesses new measurements not previously included in this type of instrument.

Pulse Characterization Measurements

Most HP universal counters provide you with a fairly complete measurement set. The 5335A possesses all these expected universal measurements, and does them better than ever before. But, beyond the expected measurement set, the 5335A has the ability to automatically measure waveform characteristics for various applications. Op Amp Characterization is one area where a number of measurements are needed to define the amplifiers performance. Using the 5335A and a signal source, rise and fall times, output slew rate, and propagation times can be measured with one test set-up. Also, duty cycle can be measured to see the distortion on a square wave through the amplifier due to different rising and falling slew rates. Lastly, phase measurements are also push-button selectable and automatically performed by the counter.

Complete Triggering Capability

To get good measurement results, a counter must properly trigger on the input signal. The 5335A employs both manual and automatic trigger modes to quickly and easily set the right trigger points.

Manual Triggering

The counter has a ± 5 VDC range to help reduce input attenuator use for most input signals, including TTL.

Automatic Triggering

Two auto trigger modes help you trigger automatically. Just press *auto trig* or select auto trig on the HP-IB; and the counter automatically selects 10%-90% Rise/Fall time trigger points, 50% phase trigger points, or the pre-set value of your choice. Then it tracks the signal's dc offset continuously to stay on the right trigger point. Option 040 allows programmability of trigger levels via HP-IB.

Trigger Level DVM

Built-in to the basic counter. Just press TRG LVL to see both input channel trigger levels displayed.

A Full Set of Universal Measurement Functions

In addition to waveform characterization features, the 5335A has an extremely wide set of measurement functions covering frequency, time, events and volts. These functions let you characterize signals quicker and more thoroughly than ever before possible.

Frequency

Frequency is the most common measurement performed by counters. The 5335A measures to 200 MHz in Channel A, 100 MHz in Channel B, and 1.3 GHz in its optional Channel C. Due to the counter's advanced design and reciprocal measurement technique, resolution is a constant 9 digits per second of gate time across its entire measurement range.

Time

In a universal counter, a time interval measurement equates to a stopwatch measurement started and stopped by unique events. Precision is dependent on the counter's circuitry.

To ensure precision, the 5335A has matched custom input amplifiers to greatly reduce trigger errors that might be produced if the start and stop signals were amplified differently. Further, the counter employs an analog interpolation technique that turns its 10 MHz clock into the equivalent of a 1 GHz time base. The 5335A is thus able to resolve single shot time interval measurements to better than 2 nanoseconds (100 ps with averaging). This analog interpolation eliminates the need found in some counters for a phase-modulated (jittered) time base for time interval average measurements.

Math and Statistics

Averaging techniques are often used to extend the resolution of a counter. For averaging, the 5335A provides sample sizes of $N = 100$ or $N = 1,000$. Best of all, averaging can be employed for all measurements except phase. In addition to mean, and selection of sample size, the counter takes standard deviations of the current measurement for the sample size selected.

Math functions are another built-in feature that provide operator convenience. These functions let you convert the display into direct indications of parameters like flow, speed, pressure, and temperature. Additionally, the counter remembers the offset, scale, and normalize factors for each measurement function.



ELECTRONIC COUNTERS

200 MHz Universal Counter

Model 5335A (cont.)

Specifications

Input Characteristics (channel A and B)

Range

DC coupled, 1 to 100 MHz.
AC 1 M Ω , 30 Hz to 100 MHz.
AC 50 Ω , 200 KHz to 100 MHz.

NOTE: Channel A range 200 MHz when in Frequency A and Ratio modes.

Sensitivity (X1)

25 mV rms sinewave.
75 mV peak-to-peak pulse at minimum pulse width of 5 ns.

Dynamic Range (X1)

75 mV to 5 V peak-to-peak, to 100 MHz.
75 mV to 2.5 V peak-to-peak, >100 MHz.

Signal Operating Range (X1, DC)

-5 V dc to +5 V dc.

Trigger Level Range (X1)

Auto Trigger OFF

Preset: set to 0 V dc NOMINAL.
Adjustable: -5 V dc to +5 V dc.

Auto Trigger ON

Preset: set to nominal 50% point of input signal.
Adjustable: nominally between + and - peaks of input signal.

Auto Trigger (X1)

Range (50% duty cycle)

DC coupled, 30 Hz to 200 MHz.
AC 1 M Ω , 30 Hz to 200 MHz.
AC 50 Ω , 200 kHz to 200 MHz.

Minimum signal: 100 mV rms.

Duty cycle range: 10% to 90%.

Response time: 3 seconds, typical.

NOTE: Auto Trigger requires a repetitive signal.

Coupling: ac or dc, switchable.

Impedance: 1 M Ω , nominal, shunted by <35 pf or 50 Ω nominal, switchable. In COMMON A, 1 M Ω is shunted by <50 pf.

Attenuator: X1 or X10 nominal, switchable.

Slope: independent selection of + or - slope.

Channel input: SEPARATE or COMMON A, switchable.

Frequency A

Range: 0 to 200 MHz, prescaled by 2.

LSD Displayed

$$\frac{1 \text{ ns}}{\text{Gate Time}} \times \text{FREQ. (e.g. 9 digits in a second)}.$$

Resolution

$$\pm (2 \times \text{LSD}) \pm 1.4 \times \frac{\text{Trigger Error}}{\text{Gate Time}} \times \text{FREQ.}$$

Accuracy: \pm (Resolution) \pm (Time Base Error) \times FREQ.

PERIOD A

Range: 10 ns to 10⁷ s.

LSD Displayed

$$\frac{1 \text{ ns}}{\text{Gate Time}} \times \text{PER. (e.g. 9 digits in a second)}.$$

Period average: user selects MEAN function, and n = 100, or n = 1,000.

Time Interval A \rightarrow B

Range: 0 ns to 10⁷ s.

LSD displayed: 1 ns (100 ps using MEAN).

Resolution: \pm (2 \times LSD) \pm (START Trigger Error) \pm (STOP Trigger Error).

Accuracy: \pm (Resolution) \pm (Time Base Error) \times TI \pm (Trigger Level Error) \pm (2 ns).

Gate mode: MIN only.

Time internal average: user selects MEAN function, and n = 100, or n = 1,000.

Time Interval Delay (holdoff)

Front panel Gate Adjust control inserts a variable delay between START and enabling of STOP. Electrical inputs during delay are ignored. Delay ranges are same as gate time ranges (100 μ s, to 4 s NOMINAL) for gate modes of Fast, Norm, and Manual.

Inverse Time Interval A \rightarrow B

Range: 10⁻¹⁰ to 10⁹ units/second

LSD Displayed, Resolution, and Accuracy are inverse of Time Interval A \rightarrow B specifications.

Rise and Fall Time A

Range: 20 ns to 10 ms transition with 50 Hz to 25 MHz repetition rates (50% duty cycle).

Minimum pulse height: 500 mV peak-to-peak.

Minimum pulse width: 20 ns.

Duty cycle range: 20% to 80%.

LSD Displayed and Resolution are same as Time Interval A \rightarrow B Specifications.

Pulse Width A

Range: 5 ns to 10⁷ s.

Trigger point range: 40% to 60% of pulse height.

LSD Displayed and Resolution are same as Time Interval A \rightarrow B specifications.

Duty Cycle A

Range: 1% to 99%, 0 to 100 MHz.

Trigger point range: 40% to 60% of pulse height.

$$\text{LSD displayed: } \frac{1 \text{ ns}}{\text{PER}} \times 100\%$$

NOTE: Constant duty cycle required during measurement.

Slew Rate A

Range: 50 V/s to 10⁸ V/s slew rate with 50 Hz to 25 MHz repetition rates (50% duty cycle). Minimum Pulse Height, Width, and Duty Cycle Range are same as Rise and Fall Time A.

Input mode: automatically set to COMMON A with 10% and 90% trigger levels.

Ratio A/B

Range: Channel A, 0 to 200 MHz (prescaled by 2).
Channel B, 0 to 100 MHz.

$$\text{LSD displayed: } \frac{\text{RATIO}}{\text{FREQ} \times \text{Gate Time}} \text{ where FREQ is higher frequency after prescaling.}$$

Totalize A

Range: 0 to 100 MHz.

LSD displayed: 1 count of input

HP-IB output: at end of gate.

Manual

Count reset: via RESET key.

HP-IB output: totalize data on-the-fly sent if cycle mode set to Single. Input frequency range in this mode is 0 to 50 Hz nominal.

Gated

Count reset: automatic after measurement.

PHASE A REL B

Range: -180 $^\circ$ to 360 $^\circ$, Range Hold off, or 0 $^\circ$ to 360 $^\circ$, Range Hold on, with signal repetition rates of 30 Hz to 1 MHz.

Minimum signal: 100 mV rms.

LSD displayed: 0.1 $^\circ$.

Gate Time

Range: 100 ns to 10⁷ s.

LSD displayed: up to three digits with Ext. Arm Enable OFF, 100 ns when ON. MIN Gate Mode display zero.



Trigger Level

Range: X1, +5 to -5 volts; X10, +50 to -50 volts.

Resolution: X1, 10 mV; X10, 100 mV.

Accuracy (X1): ± 20 mV, $\pm 0.5\%$ of reading.

Time Base

Standard Crystal

Frequency: 10 MHz.

Aging rate: $< 3 \times 10^{-7}$ /month.

Temperature: $< 4 \times 10^{-6}$, 0 to 50°C.

Line voltage: $< 1 \times 10^{-7}$ for 10% change.

High stability crystal: see Option 010.

External time base input: rear panel BNC accepts 5 or 10 MHz, 200 mV rms into 1 k Ω ; 5 V rms maximum.

Time base out: 10 MHz, > 1 V p-p into 50 Ω via rear panel.

Statistics

Sample size: selectable between either $n = 100$ or $n = 1,000$ samples.

Std. dev.: displays a standard deviation of selected sample size.

Mean: displays mean estimate of selected sample size.

Smooth: performs a weighted running average and truncates unstable least significant digits from display.

Math

All measurement functions, with exception of GATE TIME and TRIG LVL, may be operated upon by Math functions. Offset, Normalize, and Scale may be used independently or together as follows:

$$\text{Display} = \frac{\text{Measurement} + \text{Offset}}{\text{Normalize}} \times \text{Scale.}$$

Number value range: $\pm 1 \times 10^{-9}$ to $\pm 9 \times 10^9$.

Last display: causes value of previous display to Offset (negative value), Normalize, or Scale all subsequent measurements.

Measurement t-1: causes each new measurement to be Offset (negative value), Normalized, or Scaled by each immediately preceding measurement.

Hewlett-Packard Interface Bus

Programmable controls: all measurement functions, Math, Statistics, Reset, Range Hold, Ext. Arm Enable/Slope, Check, Gate Adj. (~ 1 ms to 1 s), Gate Open/Close (gate times to ∞), Gate Mode Cycle, Preset, Slope, Common A, Auto Trigger.

Special functions: FREQ B, PULSE B, TIME B \rightarrow A, TOT A \rightarrow B, LEARN, MIN, MAX, all internal diagnostic routines.

HP-IB commands: Trigger, Clear, Remote, Local, Local Lockout, Require Service.

Data output: fixed output format consisting of 19 characters plus CR and LF output is typically 8 ms.

Option 040: adds complete systems programmability; see column at right.

General

Gate: minimum, manual, or continuously variable (NORM/FAST) via Gate Adj. control.

NORM: 20 ms to 4 s NOMINAL.

FAST: 100 μ s to 20 ms NOMINAL.

MIN: minimum gate time. Actual time depends on function.

MANUAL: each press opens or closes gate.

Cycle: determines delay between measurements.

NORM: no more than 4 readings per second, nominal.

MIN: updates display as rapidly as possible (~ 15 readings per second, depending on function).

SINGLE: one measurement taken with each press of button.

Arming: Ext. Arm Enable key allows rear panel input to determine Start and/or Stop point of a measurement. External gate defined by both Start and Stop armed. All measurements are armable except Manual Totalize, Phase, and Trigger Level.

Start arm: + or - slope of arm input signal starts measurement.

Stop arm: + or - slope of arm input signal stops measurement. When used, Start Arm must occur before Stop Arm.

Ext. arm input: rear panel BNC accepts TTL into 20 k Ω . Minimum Start To Stop Time: 200 ns.

Trigger level out: dc output into 1 M Ω via rear panel BNC's for Channel A and B; not adjusted for attenuators.

Accuracy at dc (X1): ± 15 mV $\pm 0.5\%$ of TRIG LVL reading.

Gate out: TTL level into 50 Ω ; goes low when gate open; rear panel BNC.

Range hold: freezes decimal point and exponent of display.

Reset: starts a new measurement cycle when pressed.

Check: performs internal self test and lamp test.

Display: 12-digit LED display in engineering format; exponent range of +18 to -18.

Operating temperature: 0 to 50°C.

Power requirements: 100, 120, 220, 240 VAC (+5%, -10%), 48-66 Hz; 130 VA max.

Weight: net, 8.8 kg (19 lbs. 8 oz.). Shipping, 13.6 kg (30 lbs.)

Dimensions: 425.5 mm W x 132.6 mm H x 345.4 mm D (16 $\frac{3}{4}$ " x 5 $\frac{1}{4}$ " x 13 $\frac{1}{2}$ "), not including removable handles.

Options

Option 010: High Stability Time Base (oven)

Frequency: 10 MHz.

Aging rate: $< 5 \times 10^{-10}$ /day after 24 hour warm up.

Short term: $< 1 \times 10^{-10}$ rms for 1s average.

Temperature: $< 7 \times 10^{-9}$, 0 to 50°C.

Line voltage: $< 1 \times 10^{-10}$ for 10% change.

Warm-up: within 5×10^{-9} of final value in 20 minutes.

Option 020: DC Digital Voltmeter

Range: 4 digits, autoranging, autopolarity, in ± 10 , ± 100 , ± 1000 V ranges.

Sensitivity: 100 μ V, 1 mV, 10 mV, 100 mV for ± 1 V, ± 10 V, ± 100 V, ± 1000 V readings.

LSD displayed: same as sensitivity.

Input type: floating pair.

Input impedance: 10 M Ω $\pm 1\%$.

Option 030: 1.3 GHz C Channel

Input Characteristics

Range: 150 MHz to 1.3 GHz.

Sensitivity: 10 mV rms sinewave (-27 dBm) to 1 GHz. 100 mV rms sinewave (-7 dBm) to 1.3 GHz.

Frequency C

Range: 150 MHz to 1.3 GHz, prescaled by 20. LSD Displayed, Resolution, and Accuracy are same as Frequency A.

Ratio C/A

Range: channel A, 0 to 200 MHz.

channel C, 150 to 1300 MHz.

Option 040: Complete Systems Programmability

Adds remote selection of low pass filter, ac/dc coupling, X1-X10 attenuation, dc trigger level and input impedance for both Channel A and B.

Definitions

Duty cycle: percentage of time a signal is high or low, depending on Slope A setting. Trigger point is high/low dividing point.

$$\text{DUTY CY} = \frac{\text{PULSE}}{\text{PER}} \times 100\%.$$

Slew rate: effective slope between 10% and 90% points of rising or falling signal depending on Slope A setting.

$$\text{SLEW} = \frac{V_B - V_A}{T_I}$$

Phase: angle, with respect to B signal, between 50% points of channel A and B signals, trigger slopes selected by Channel A and B slope switches.

$$\text{PHASE} = (T_{I1} + T_{I2}) \div \frac{2}{\text{PER}} \times 360^\circ$$

T_{I1} is time between 50% points of A then B signals using slopes defined during Phase measurement.

T_{I2} is time between 50% points of A then B signals using complement slopes to T_{I1} .

Front handles: supplied with instrument.

Ordering Information

Option 010: Oven Oscillator

Option 020: DVM

Option 030: C Channel

Option 040: Expanded HP-IB Control

Option 908: Rack Flange Kit for use without handles

Option 913: Rack Flange Kit for use with supplied front handles

5335A Universal Counter



ELECTRONIC COUNTERS

100 MHz Universal Counters

Model 5334A

- Two matched 100 MHz channels; optional 1.3 GHz channel C
- 9 digits per second resolution over the entire frequency range in one second
- 2 ns single shot time interval resolution
- Automatic rise/fall time, pulse width and peak amplitude measurements
- Store/recall of up to 10 front panel setups
- Complete HP-IB programmability including trigger levels

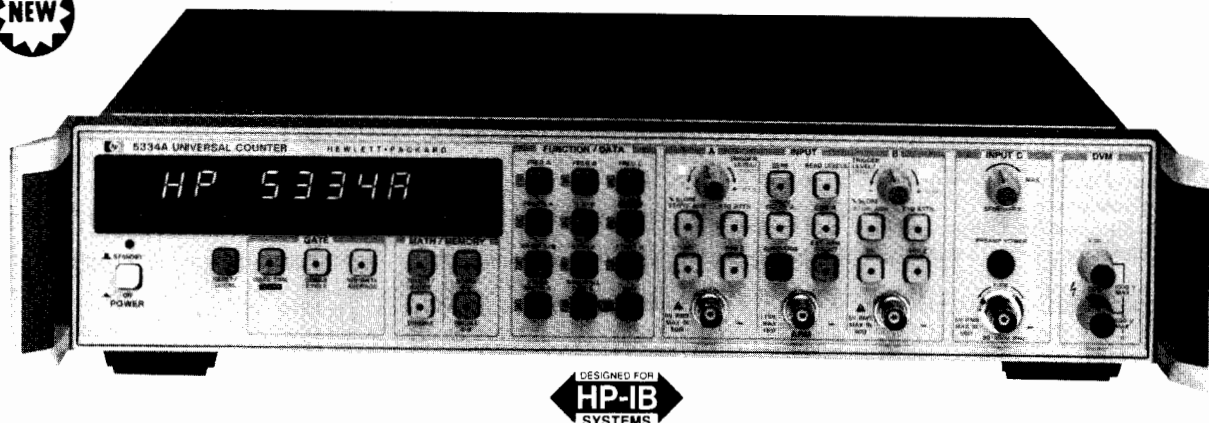

The 5334A is a two-channel, 100 MHz Universal Counter with 9 digits in one second resolution and 2 ns single shot time interval resolution. Frequency, period, rise time, fall time, pulse width and peak amplitude may be measured automatically—all at the touch of a button. Options include a high-stability oven oscillator, a ± 1000 V DVM and a 1.3 GHz C-Channel.

Fully Programmable

Complete HP-IB capability standard is a first for counters in this class, opening up new possibilities for ATE applications. All front panel controls are programmable including input signal conditioning and trigger levels. Optional rear terminal inputs simplify cabling in rack-mounted systems.

Peak Amplitudes

The peak amplitude function adds a new dimension to universal counter applications. For any waveshape up to 20 MHz, the 5334A measures not only time and frequency, but also the maximum and minimum peak amplitudes of Channel A or B input signals. Often this function reduces the need for additional test equipment and gives a more complete picture of the input signal.

Input Signal Conditioning

In addition to automatic capability, independent selection of input signal conditioning provides flexibility for any application. Accurate triggering is ensured by selection of trigger slope, coupling, input impedance, attenuation, low pass filter, and variable sensitivity. Variable sensitivity may be used to widen the hysteresis band for measurements on noisy input signals.

Triggering Alternatives

The 5334A offers four alternatives for trigger level selection. Auto Trigger offers maximum convenience. The maximum and minimum peaks of the input signal are found automatically, and the optimum trigger point calculated. Auto Attenuator is enabled with Auto Trigger, ensuring correct counting by selecting the X10 attenuator when the input signal amplitude is greater than the input signal operating range.

The trigger levels may also be set manually over the range of -5.10 V to $+5.10$ V (-51.0 V to $+51.0$ V in X10 attenuation). Read Levels may be used to display the current trigger level control settings. Storing trigger levels from the front panel and programming trigger levels over HP-IB complete the alternatives for reliable and accurate triggering.

Store/Recall

Up to ten instrument setups including trigger levels may be stored in a nonvolatile memory and conveniently recalled. Sequencing through several complicated setups requires much less time and results in repeatable, exact measurement setups.

Math

Math functions let you view results in measurement units of your choice such as velocity, flow, or ppm. Normalize divides the measured value by a constant. Offset adds or subtracts the measured value by a constant.

External Arming

Synchronize a measurement to a real time event or events. Start arm is used alone to enable the start of a measurement, stop arm to enable the stop of a measurement. External gating is accomplished by arming both the start and stop of a measurement. This capability facilitates applications such as measuring the frequency within a pulsed RF signal and averaging for increased resolution, selecting a specific time interval within a pulse train, and selecting a portion of a pulse train to totalize.

The arm input and slope selection are conveniently located on the front panel and are programmable over HP-IB. The trigger level at which the arm signal will arm a measurement may be selected from -4 V to $+4$ V via a rear panel control.

Condensed Specifications

Input Characteristics (channels A and B)

Range

DC coupled: 0 to 100 MHz.

AC coupled: 1 M Ω , 30 Hz to 100 MHz, 50 Ω , 1 MHz to 100 MHz.

Sensitivity

15 mV rms sine wave to 20 MHz, 35 mV rms sine wave to 100 MHz.

100 mV peak-to-peak at a minimum pulse width of 5 ns.

Sensitivity can be continuously varied to 150 mV rms, (NOMINAL) using the TRIGGER LEVEL/SENS control in sensitivity mode. (Trigger levels set to 0 V NOMINAL.)

Dynamic Range (X1)

45 mV to 5 V peak-to-peak, to 20 MHz.

100 mV to 2.5 V peak-to-peak, to 100 MHz.

Signal operating range, dc: ± 5 V DC (X ATTN).

Trigger Level Range

Manual (auto trigger off): continuously adjustable over ± 5.1 V, displayed in 20 mV steps. In X10, ± 51 V displayed in 200 mV steps.

Preset: 0 V NOMINAL in Sensitivity Mode.



Auto Trigger

DC coupled: 100 Hz to 100 MHz.

AC coupled: 1 M Ω , 100 Hz to 100 MHz. 50 Ω , 1 MHz to 100 MHz.

Coupling: ac or dc, switch selectable.

Trigger slope: independent selection of + or - slope.

Impedance: 1 M Ω NOMINAL shunted by <60 pf or 50 Ω NOMINAL, switch selectable.

Attenuator

Manual: X1 or X10 NOMINAL, switch selectable.

Auto: attenuator automatically switched when in Auto Trigger.

Low pass filter: 100 kHz NOMINAL, switchable in or out of Channel A.

External Arm

Minimum width: 50 ns.

Maximum transition time: 1 μ s.

Sensitivity: 500 mV peak-to-peak.

Signal operating range: -5 Vdc to +5 Vdc.

Slope: independent selection of START and STOP ARM slopes: +, -, or OFF.

Frequency A and Frequency B

Range: .001 Hz to 100 MHz.

LSD: (4ns/Gate Time) X FREQ.

Resolution

$$\pm \text{LSD} \pm \frac{(1.4 \times \text{Trigger Error} + 1 \text{ ns rms})}{\text{Gate Time}} \times \text{FREQ.}$$

Accuracy: \pm Resolution \pm Time Base Error \times FREQ.

Period A

Range: 10 ns to 10³ s.

LSD: (4 ns/Gate Time) \times PER.

Resolution

$$\pm \text{LSD} \pm \frac{(1.4 \times \text{Trigger Error} + 1 \text{ ns rms})}{\text{Gate Time}} \times \text{PER.}$$

Accuracy: \pm Resolution \pm Time Base Error \times PER.

Time Interval A to B

Range: -1 ns to 10³ seconds.

LSD: 1 ns (100 ps using 100 GATE AVERAGE).

Resolution: \pm LSD \pm Start Trigger Error \pm Stop Trigger Error \pm 1 ns rms.

Accuracy: \pm Resolution \pm (Time Base Error \times TI) \pm Trigger Level Timing Error \pm Trigger Level Setting Error \pm 2 ns.

Time Interval Delay

Used with Time Interval A to B, a selectable delay can be inserted between START (Channel A trigger) and STOP (Channel B trigger). Electrical inputs during delay are ignored. Delay Range is 1 ms to 99.999 s (1 ms steps).

Ratio A/B

Range: .001 Hz to 100 MHz both channels.

LSD: 4 \times RATIO/(FREQ A \times Gate Time).

Resolution and Accuracy

$$\pm \text{LSD} \pm (\text{B Trigger Error/Gate Time}) \times \text{RATIO.}$$

Totalize A

Range: 0 to 10¹² -1.

LSD: 1 count of input signal.

Resolution and accuracy: \pm LSD.

Pulse Width A

Range: 5 ns to 10 ms.

LSD: 1 ns (100 ps using 100 GATE AVERAGE).

Resolution: \pm LSD \pm Start Trigger Error \pm Stop Trigger Error \pm 1 ns rms.

Rise/Fall Time A

Range: 30 ns to 10 ms.

Minimum amplitude: 500 mV peak-to-peak.

Dynamic range: 500 mV to 40 V peak-to-peak.

LSD: 1 ns (100 ps using 100 GATE AVERAGE).

Resolution: \pm LSD \pm Start Trigger Error \pm Stop Trigger Error \pm 1 ns rms.

Read Peak Amplitudes

Maximum and minimum peaks of Channel A or Channel B input are displayed.

Frequency range: DC, 100 Hz to 20 MHz.

Dynamic range: 0 V to 40 V peak-to-peak.

Resolution: \times 1: 20 mV. \times 10: 200 mV.

Time Base

Standard Crystal

Frequency: 10 MHz.

Aging rate: $<3 \times 10^{-7}$ per month.

Temperature: $<5 \times 10^{-6}$, 0 $^\circ$ to 50 $^\circ$ C.

Line voltage: $<1 \times 10^{-7}$ for 10 % change.

External input: rear panel BNC accepts 10 MHz, 500 mV to 5 V rms.

Time base output: 10 MHz, >500 mV rms sine wave into 50 Ω via rear panel.

Gate time range: 1 ms to 99.999 seconds in 1 ms increments.

Math

Display = (Measurement/Normalize) + Offset.

Entry range: $\pm 1 \times 10^{-10}$ to $\pm 9.999999999999 \times 10^9$.

Single cycle: when enabled, one measurement is taken with each push of RESET key.

100 gate average: 100 gates accumulated and average displayed. This adds an additional digit of resolution.

Gate output: rear panel BNC drives TTL levels into 1 k Ω .

Hewlett-Packard Interface Bus

Programmable controls: all front panel controls and functions, except Option 030 Channel C sensitivity and power on/stby switch.

Trigger level: set Channel A or B from -5.1 V to +5.1 V in 20 mV steps (\times ATTN).

Other: Initialize, Transmit Error, High-Speed Output, Transmit Calibration Data, Device ID, and SRQ Mask.

Data Output

Normal operation: format: 19 characters plus CR and LF. Rate: Ten readings/second.

High speed output mode: format: 8 bytes of count data and Interpolator Start and Stop counts. Rate: 150 readings/second.

Options

Option 010 High Stability Time Base (Oven)

Frequency: 10 MHz.

Aging rate: $<5 \times 10^{-10}$ /day after 24-hour warm up.

Short term: $<5 \times 10^{-10}$ rms for a 1-second average.

Temperature: $<7 \times 10^{-9}$, 0 to 50 $^\circ$ C.

Line voltage: $<5 \times 10^{-10}$ for 10% change (2 minutes after change).

Warm up: within 5×10^{-9} of final value in 20 minutes.

Option 020 DC Digital Voltmeter

Range: 4 digits, autoranging, and autopolarity in ± 10 V, ± 100 V, ± 1000 V ranges.

Sensitivity and LSD: 100 μ V for ± 1 V reading. 1 mV for ± 10 V reading. 10 mV for ± 100 V reading. 100 mV for ± 1000 V reading.

Input type: floating pair.

Input resistance: 10 M Ω $\pm 1\%$.

Option 030 1300 MHz C Channel

Range: 90 MHz to 1300 MHz.

Sensitivity: 15 mV rms (-23.5 dBm) sine wave, 90 MHz to 1000 MHz. 75 mV rms (-9.5 dBm) sine wave, 1000 MHz to 1300 MHz.

Ordering Information

Option 010: Oven Oscillator

Option 020: DVM

Option 030: Channel C

Option 050: Both option 020 and 030, order instead of both options separately.

Option 060: Rear Terminals

Channel A, B and ARM in parallel with front inputs. Options 020 and 030 at rear panel only.

Option 908: Rack Mount Kit for use without front handles.

Option 913: Rack Mount Kit for use with supplied front handles.

5334A Universal Counter

ELECTRONIC COUNTERS

100 MHz Universal Counters

Model 5328A

- 100 MHz, 512 MHz and 1300 MHz
- 100 ns or 10 ns time interval
- T.I. averaging to 10 ps resolution
- "Armed" measurements
- DVM options
- HP-IB interface option

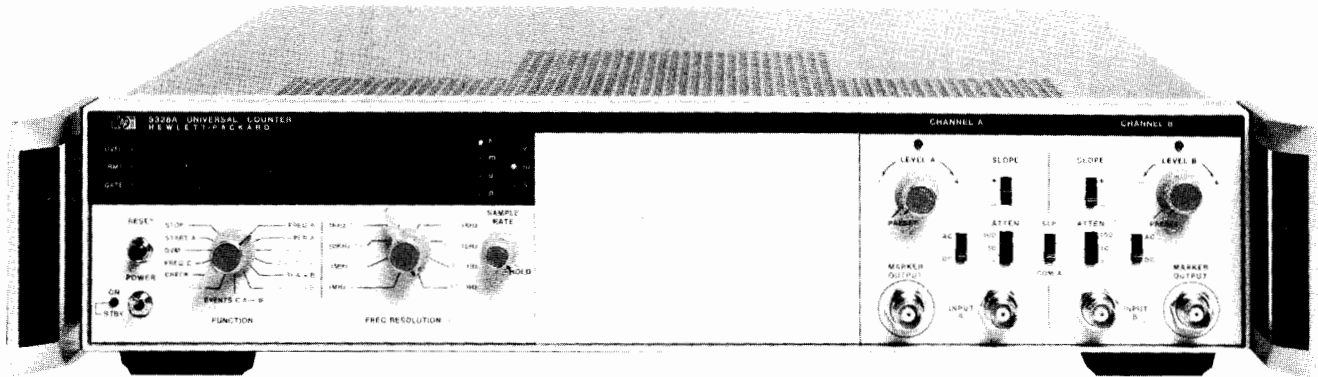

5328A

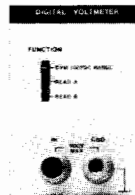

Opt 020

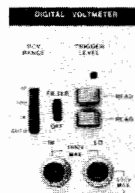

Opt 021



Opt 030

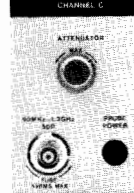

Opt 031

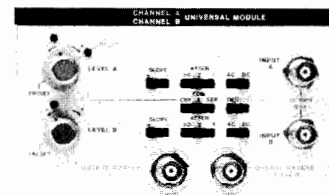

Opt 040

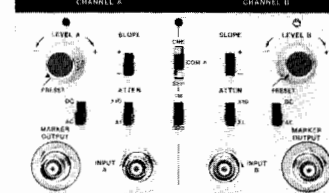

Opt 041

Description

The 5328A, thru the use of technology such as a ROM controlled measurement cycle and a modular design, provides you with excellent universal counter price/performance. Optional modules allow you to tailor the performance of the 5328A to meet your particular measurement needs. In many instances, however, the standard 5328A offers all the capability you're likely to need.

Burst and CW measurements to 100 MHz: special gating circuits start a measurement only when the input signal is present, allowing burst frequencies to be measured as easily as CW signals. The option 030 C Channel extends this capability to 512 MHz; option 031, to 1300 MHz.

Single shot time interval measurements: the standard universal module's 100 ns single shot resolution meets or exceeds the requirements for a wide range of applications such as mechanical and electromechanical device timing (relays), time of flight measurements (ballistics), sonar ranging, radio ranging and navigation.

Time interval averaging: resolution better than 10 ps (10^{-11} seconds) for repetitive time intervals as short as 100 ps.

General

Display: 9 digit LED display, ninth digit used only with channel C functions (FREQ. C, Ratio C/A, Events C, A→B).

Blanking: suppresses display of unwanted zeros to left of most significant digit.

Storage: holds reading between samples; can be overridden by rear panel switch.

Sample rate: variable from less than 2 ms between measurements to HOLD which holds display indefinitely.

Gate output: rear panel output, TTL levels; high if gate is open.

Period, period average, ratio, totalize, scale: extra problem solving power for your special requirements.

Armed measurements: versatile arming modes (controlled by a rear panel switch) allow real time control over when a measurement begins. Useful for measurements such as frequency burst profile and frequency sweep linearity.

Trigger lights: trigger light blinks when channel is triggering; light is ON when input is above trigger level; OFF when input is below trigger level. Simplifies trigger level adjustments.

High performance marker outputs: marker outputs (operational to 100 MHz) indicate where channel is triggering in real time for oscilloscope monitoring applications. Provides measurement feedback to the operator for greatly simplified measurement set-ups.

These features and capabilities make the 5328A an excellent choice for general purpose lab use, electronic service, and production test. For more demanding applications, a variety of options offer extended performance at a modest increase in price.

Time base output: rear panel output: TTL levels.

Check signal: with function switch in CHECK, counter should display $10 \text{ MHz} \pm 1$ count. With options 040 and 041, place function switch in FREQ A and universal module in CHECK (CHK). Counter should display $100 \text{ MHz} \pm 1$ count.

Operating temperature: 0° to 50° C .

Power requirements: 100/120/220/240 V rms, +5%, -10% (switch selectable), 48-66 Hz; 150 VA max.



Standard Universal Module

Input Characteristics

Sensitivity: 25 mV rms, to 40 MHz

50 mV rms, 40 MHz – 100 MHz

Impedance (nominal): separate: 1 M Ω //<40 pF;

common: 1 M Ω //<65 pF

Attenuators (nominal): X1, X10, X100 switch selectable

Frequency A

Range: 0 to 100 MHz with resolution to 0.1 Hz

Period A

Range: 100 ms to 10⁸ with resolution to 100 ns

Period Average A

Range: 100 ns to 10⁸ s with resolution to 100 ps

Time Interval A—B

Range: 100 ns to 10⁸ s with resolution to 100 μ s

Time Interval Average A—B

Range: 0.1 ns to 10 s with resolution to 100 ps

Minimum dead time: 150 ns

Ratio B/A

Range: channel A, 0 to 10 MHz; channel B, 0 to 100 MHz

Time Base Oscillators

Standard Crystal Oscillator

Frequency: 10 MHz

Aging rate: <3 x 10⁻⁷/month

Temperature: $\pm 2.5 \times 10^{-6}$, 0° to 50°C

Line voltage: <1 x 10⁻⁷ for 10% change

Opt 010 Oven Oscillator

Frequency: 10 MHz

Aging rate: <5 x 10⁻¹⁰/day after 24-hour warm-up

Short term: <1 x 10⁻¹⁰ rms/s

Temperature: <7 x 10⁻⁹, 0° to 50°C

Line voltage: $\pm 5 \times 10^{-9}$ for 10% variation

Warm-up: within 5 x 10⁻⁹ of final value in 20 minutes

Ext. freq. std. input: 30 kHz to 10 MHz signal of amplitude > 1.0 V rms into 1 k Ω . Maximum input: 5 V p-p. With options 040 and 041 the external frequency standard must be 10 MHz for Period Avg., T.I. Avg., Period (N = 1), and T.I. (N = 1).

Option 011: HP-IB Interface

Option 011 provides digital output of measurement data (“talker”) as well as input for remote program control (“listener”). HP-IB cable not supplied.

Programmable features: function, resolution, sample rate (max or manual control), arming, display modes, measurement cycle modes, output modes, and reset commands. Option 041 adds control of channel A and B trigger level, slope, attenuator, coupling, input impedance, and SEP-COM-CHECK selection.

HP-IB commands: responds to the following bus commands (see HP-IB Users Guides for definitions)—Unlisten, Untalk, Local Lockout, Device Clear, Serial Poll Enable, Serial Poll Disable, Go to Local, Selected Device Clear, and Group Execute Trigger

Service request (SRQ): if enabled, indicates end of measurement

Maximum data output rate: 500 readings/s

Option 020: Digital Voltmeter

Range: ± 125 Vdc

Sensitivity: 1 mV, 1 mV, 2 mV, 20 mV, 200 mV for measurement times of 10 s, 1 s, 0.1 s, 10 ms, 1 ms respectively

Input type: single ended

Impedance: 10 M Ω Nominal

Maximum input: ± 500 V

Trigger level measurements: 2 mV display resolution

Option 021: High Performance Digital Voltmeter

Range: ± 10 , ± 100 , ± 1000 V dc and Autorange

Sensitivity: 10 μ V, 100 μ V, 1 mV, 10 mV, 100 mV for measurement times of 10 s, 1 s, 0.1 s, 10 ms, 1 ms respectively

Input type: floating pair

Impedance: 10 M Ω Nominal

Maximum input: hi to lo: ± 1100 V all ranges
lo to chassis ground: ± 500 V

Trigger level measurements: 1 mV display resolution

Note: trigger level readings are multiplied automatically by attenuator setting of using options 040 or 041.

Option 030: 512 MHz C Channel

Input Characteristics

Sensitivity: 15 mV rms sine wave (–23.5 dBm)

Input protection: fused input

Maximum input: 5 V rms

Frequency C

Range: 5 MHz to 512 MHz, direct count with resolution to 0.1 Hz

Ratio C/A

Range: channel A, 0 to 10 MHz; channel C, 5 to 512 MHz

Events C, A—B: totalizes the number of events at C input during the synchronized time interval as defined by inputs to A and B

Option 031: 1300 MHz C Channel

Input Characteristics

Sensitivity: 20 mV rms sine wave (–21 dBm)

Input protection: fused input

Maximum input: 5 V rms, ± 5 V dc

Frequency C

Range: 90 MHz to 1300 MHz, prescaled by 4 with resolution to 0.1 Hz

Ratio C/A

Range: channel A, 0 to 10 MHz; channel C, 90 to 1300 MHz

Attenuation: continuously variable for optimum noise suppression

Extended Capability Universal Modules (option 040 and 041)

Input Characteristics

Sensitivity: same as standard unit

Impedance (nominal): 10 M Ω or 50 Ω , switch selectable

Attenuators (nominal):

Option 040—X1, X2, X20 switch selectable

Option 041—X1, X10 switch selectable

Frequency A: same as standard unit

Period A

Range: 100 ns to 10⁸ s with resolution to 10 ns

Period Average A

Range: 100 μ s to 10⁸ s with resolution to 0.01 ps

Time Interval A—B

Range: 10 ns to 10⁷ s with resolution to 10 s

Time Interval Average A—B

Range: 0.1 ns to 1 s with resolution to 10 ps

Minimum dead time: 40 ns

Ratio A/B: same as standard unit

Delay (option 040 only): 20 μ s to 20 ns

Programmable control (option 041 only): Level, Slope, Coupling, Attenuation, Impedance, SEP—COM—CHK

Options and Accessories

010: High Stability Time Base

011: HP-IB Interface

020: DVM

021: High Performance DVM

030: 512 MHz Channel C

031: 1300 MHz Channel C

040: High Performance Universal Module

041: Programmable Input Controls Module
(Requires Option 011 for HPIB use)

908: Rack Flange Kit for use w/o front handles

913: Rack Flange Kit for use with supplied front handles

10855A Preamp

10856A Filter Kit

5363B Time Interval Probes

5328A Universal Counter

Front Handles: supplied with instrument



ELECTRONIC COUNTERS

Universal Counters

Models 5315A/B, 5316A

- Frequency, period, ratio, and totalize to 100 MHz
- Three versions: portable, rackable, or HPIB
- 1 GHz capability available
- Uses reciprocal technique for full low-frequency resolution
- 100 ns time interval, 10 ps T.I. averaging
- Oven option for increased accuracy

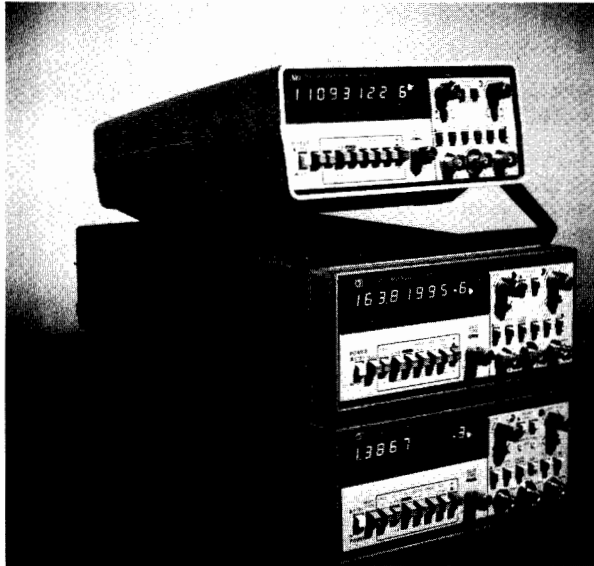

A Quiet Revolution in Capability . . .

HP's economical 5315A/B, and 5316A counters provide all the universal counter capability you've come to expect at much higher prices. That's because they use a unique custom circuit called the MRC (Multiple Register Counter) which packs counting and computing power into this popular counter series. To a user, the differences in operation from conventional direct models can be listed quickly: low frequency resolution is an outstanding 7 digits per second of gate time and reliability is extremely good due to the counter's low chip count. Also, the continuously adjustable gate time allows automatic selection of sample size for easy trade-offs between measurement time and resolution.

Much of the counter's performance is based on reciprocal counting techniques first pioneered in HP's high-performance 5360A computing counter, and the current model 5345A Universal Counter. The use of these techniques coupled with HP's MRC and a microprocessor provide a quiet but powerful revolution in counter performance within the 5315A/B and 5316A. For example, this counter gives you its full 7-digits/second resolution over the range from 1 Hz to 100 MHz. This, simply stated, shows the power of the MRC and reciprocal counting.

High Performance, Low Price

In addition to its economy, the MRC counter offers a full set of universal counter measurements, and there are very few limitations to this capability. Increased accuracy in low-cost portable and system counters is also available with the oven oscillator option through improved temperature stability and lower aging rates.

Frequency to 100 MHz, C-Channel to 1.0 GHz

The MRC counter measures frequency to 100 MHz. Additionally the optional C-Channel measures to 1.0 GHz for both CW and pulsed RF signals as narrow as 60 ms. The C-Channel option is particularly useful in navigation and communications equipment testing due to this pulsed RF measurement feature.

Time Interval to 100 ns, T.I. Averaging to 10 ps

The MRC counter provides three time measurement modes. Single-shot time interval allows measurements over a range of 100 ns to 100,000 seconds. This capability can be used to measure pulse width. Time interval averaging provides greater resolution for repetitive events. Finally, time interval delay avoids measurement of spurious signals by holding off the counter's trigger point by a precise, operator-selectable amount of time.

A Full Set of Measurements

Besides the frequency and time functions mentioned above, the MRC counter has other measurement functions that make it a truly impressive value:

Period A—allows single period measurements via Channel A.

Ratio A/B—allows frequencies to 100 MHz into both Channel A and B

A By B—totalizes the A input between 2 events on B channel

Totalize—a manually gated totalize mode of operation

Input Signal Conditioning Versatility

A full complement of input signal conditioning controls are provided for both channels. These include \pm slope, ± 2.5 VDC trigger level, and AC/DC coupling. Other controls are a Separate/Common switch, and a 100 KHz low-pass filter for Channel A.

A Choice of Three Models

The MRC counter is available in three different versions: **5315A**: a portable, light-weight unit best suited for field applications. This unit has a convenient carrying handle and optional battery power is available for up to 4 hours continuous operation. Despite its high impact plastic case, the 5315A possesses low RFI/EMC characteristics making it equally suitable for bench use.



5315B: a rackable, stackable counter that is designed to meet the most demanding RFI/EMC specs, the 5315B is intended primarily for rack mount use. This model has an optional Offset-Normalize (006) module that mathematically modifies the counter's display and so provides readouts directly in engineering units of the user's choice. The 5315B Option 006 is also rackable and stackable.

5316A: this model possesses all the characteristics of both the 5315A and 5315B, and it has HP-IB capability built-in as standard equipment. It has low RFI, it is rackable, and it is functionally identical to the 5315A/B. In addition to programmable measurement functions, the user can also select dc trigger level and \pm slope under HP-IB control. Channel A and B trigger levels are brought out to the front panel on this unit for easy measurement with a DVM.

5315A/B 5316A Specifications

Input Characteristics (channel A and channel B)

Range: dc coupled 0 to 100 MHz.

ac coupled 30 Hz to 100 MHz.

Sensitivity: 10 mV rms sine wave to 10 MHz.

25 mV rms sine wave to 100 MHz.

75 mV peak-to-peak pulse at minimum pulse width of 5 ns.

Sensitivity can be varied continuously up to 500 mV rms *NOMINALLY* by adjusting sensitivity control. In sensitivity mode, trigger level is automatically set to 0 V *NOMINAL*.

Dynamic Range

30 mV to 5 V peak-to-peak, 0 to 10 MHz.

75 mV to 5 V peak-to-peak, 10 to 100 MHz.

Coupling: ac or dc, switchable.

Filter: low pass, switchable in or out of Channel A. 3 dB point of 100 kHz *NOMINALLY*.

Impedance: 1 M Ω *NOMINAL* shunted by less than 40 pF.

500 K Ω *NOMINAL* shunted by less than 70 pF (COMMON A).

Signal operating range: +2.5 Vdc to -2.5 Vdc.

Attenuator: X1 or X20 *NOMINAL*.

Trigger level: variable between +2.5 Vdc and -2.5 Vdc.

Slope: independent selection of + or - slope.

Common input: all specifications are the same for Common A except the following:

Sensitivity: 10 mV rms sine wave to 10 MHz; 25 mV rms sine wave to 50 MHz; 50 mV rms to 100 MHz; 150 mV peak-to-peak at a minimum pulse width of 5 ns.

Dynamic range: 30 mV to 5 V peak-to-peak to 10 MHz; 75 mV to 5 V peak-to-peak, 10-50 MHz; 150 mV to 5V peak-to-peak, 50-100 MHz.

Impedance: 500 k Ω *NOMINAL* shunted by less than 70 pF.

Damage Level

ac & dc X 1:

dc to 2.4 kHz

250 V (dc + ac rms)

2.4 kHz to 100 kHz

6×10^5 V rms Hz/FREQ

> 100 kHz

6 V rms

ac & dc X 20:

dc to 28 kHz

500 V (dc + ac peak)

28 kHz to 100 kHz

1×10^7 V rms Hz/FREQ

> 100 kHz

100 V rms

Frequency (channel A)

Range: .1 Hz to 100 MHz.

LSD displayed: 10 Hz to 1 n Hz depending upon gate time and input signal. At least 7 digits displayed per second of gate time.

Period

Range: 10 ns to 10^5 s.

LSD displayed: 100 ns to 1 fs depending upon gate time and input signal. At least 7 digits displayed per second of gate time.

Time Interval

Range: 100 ns to 10^5 s.

LSD displayed: 100 ns.

Time Interval Average

Range: 0 ns to 10^5 s.

LSD displayed: 100 ns to 10 ps depending upon gate time and input signal.

Number of intervals averaged (N): N = Gate Time x FREQ.

Minimum dead time (stop to start): 200 ns.

Time Interval Delay (holdoff)

Front panel gate time knob inserts a variable delay of *NOMINALLY* 500 μ s to 30 ms between START (Channel A) and enabling of STOP (Channel B). Electrical inputs during delay time are ignored. Delay time may be digitally measured by simultaneously pressing T.I. Averaging, T.I. Delay and blue key.

Ratio

Range: 0.1 Hz to 100 MHz, both channels

LSD: $\frac{2.5 \times \text{Period A}}{\text{Gate Time}} \times \text{Ratio}$. (rounded to nearest decade)

Totalize

Manual

Range: 0 to 100 MHz.

A gated by B

Totalizes input A between two events of B. Instrument must be reset to make new measurement. Gate opens on A slope, closes on B slope.

Range: 0 to 100 MHz.

General

Standard Time Base

Frequency: 10 MHz

Aging rate: $< 3 \times 10^{-7}$ /mo.

Temperature: $\pm 5 \times 10^{-6}$, 0° to 50°C

Line voltage: $< 1 \times 10^{-7}$ for a $\pm 10\%$ variation.

Check: counts internal 10 MHz reference frequency over gate time range *NOMINALLY* 500 μ s to 30 ms.

Error light: LED warning light activated if logic error is found during instrument turn-on self-check.

Display: 8 digit amber LED display, with engineering units annunciator.

Overflow: only frequency and totalize measurements will overflow. In case of overflow, eight least significant digits will be displayed and amber front panel overflow LED will be actuated.

All other measurements which would theoretically cause a display of more than 8 digits will result in the display of the 8 most significant digits.

Gate time: continuously variable, *NOMINALLY* from 60 ms to 10 s or 1 period of the input, whichever is longer.

Sample rate: up to 7 readings per second *NOMINAL* except in time interval mode, where it is continuously variable *NOMINALLY* from 250 ms to 10 s via Gate Time Control.

Operating temperature: 0° to 50°C.

Power requirements: 100, 120, 220, 240 V (+5%, -10%) 48-66 Hz; 15 VA maximum or 30 VA maximum (5316A).

Weight: net, 2.2 Kg (4 lbs. 12 oz.). Shipping, 4.1 Kg (9 lbs.).

Dimensions: 238 mm W x 98 mm H x 276 mm D (9 $\frac{3}{8}$ " x 3 $\frac{3}{8}$ " x 10 $\frac{7}{8}$ ").

Additional 5315B Specifications

Rack and stack metal case with rear panel, switchable AC power line module. Specifications same as 5315A except as follows:

Rack mount: 5061-0072 recommended.

Oscillator output: 10 MHz, 50 mV pk-pk into 50 Ω load, on rear panel.

External frequency standard input: 10 MHz, 1 V RMS into 500 Ω , on rear panel.

Dimensions: 212 mm W x 88 mm H x 345 mm D (8 $\frac{3}{8}$ " x 3 $\frac{1}{2}$ " x 13 $\frac{3}{4}$ ").

Weight: net, 3.2 Kg (7 lbs. 2 oz.). Shipping, 4.5 Kg (10 lbs.).



ELECTRONIC COUNTERS

Universal Counters

Models 5315A/B, 5316A (cont.)

Additional 5316A Specifications

Rack and stack metal case with rear panel, switchable ac power line module, Specifications same as 5315A except as follows:

Rack mount kit: 5061-0072 recommended.

Oscillator output: 10 MHz, 50 mV p-p into 50 Ω load on rear panel.

External frequency standard input: 1, 5, 10 MHz, 500 mV rms into 500 Ω, or rear panel.

Trigger level output: ±5%, ±15 mV, over ±2.0 VDC range at front panel connectors.

Dimensions: 212 mm W x 88 mm H x 415 mm D (8 3/8 x 3 1/2 x 16 1/2")

Weight: net, 3.9kg (8 lbs. 10 oz.). Shipping, 6.3kg (14 lbs.)

Hewlett-Packard Interface Bus

Programmable functions: Frequency A, Frequency A Armed by B, Totalize, A Gated by B, Ratio A/B, Time Interval Average A→B, Time Int. Delay, Read Gate Time, Display Test, 10 MHz Check, Interface Test, Initialize, Reset, Wait State ON/OFF.

Programmable controls: Gate Time Command which sets long (60 ms to 10 s) or short (500 μs to 30 ms) range; Trigger Level Commands which set Channel A and/or B slope (±) and Channel A and/or B trigger from - 2.50 Vdc to + 2.50 Vdc in steps of .01V.

Interface functions: Group Execute Trigger, Device Clear, Selected Device Clear, Interface Clear, Local, Remote, Local Lockout, Read Status (serial poll enable), Request Service.

Options

Opt. 001: High Stability Time Base (TCXO)

Frequency: 10 MHz.

Aging rate: < 1 × 10⁻⁷/mo.

Temperature: ± 1 × 10⁻⁸, 0° to 40°C.

Line voltage: < 1 × 10⁻⁸ for ± 10% variation.

Opt. 002: battery (5315A only)

Type: rechargeable lead-acid (sealed).

Capacity: TYPICALLY 4 hours of continuous operation at 25°C.

Recharging time: TYPICALLY 16 hours to 98% of full charge, instrument non-operating. Charging circuitry included with Option. Batteries not charged during instrument operation.

Low voltage indicator: instrument turns itself off automatically when low battery condition exists. *Discharge* LED flashes slowly when this happens. *Discharge* LED is on whenever battery is supplying power to instrument.

Charge LED indicates state of charge of battery during charging only and is on whenever battery is charged to 95% *NOMINAL* of capacity. *Charge* LED flashes when 90% *NOMINAL* of charge taken out is replaced. *Charge* LED is off if charge is less than 70% *NOMINAL* of capacity.

Line failure protection: instrument automatically switches to battery in case of line failure.

Weight: Opt. 002 adds 1.4 Kg (3 lbs.) to weight of instrument.

Option 003: C Channel

Input Characteristics

Range: 50 to 1000 MHz, prescaled by 10.

Sensitivity: 15 mV rms sinewave (-23.5 dBm) to 650 MHz. 75 mV rms sinewave (-9.5 dBm) to 1000 MHz.

Sensitivity can be decreased continuously by up to 20 dB *NOMINAL*, 50 to 500 MHz and 10 dB *NOMINAL*, 500 to 1000 MHz by adjusting sensitivity control. Trigger level is fixed at 0 V *NOMINAL*.

Dynamic range: 15 mV to 1 V rms (36 dB), 50 to 650 MHz. 75 mV to 1 V rms (20 dB), 650 to 1000 MHz.

Signal operating range: +5 V dc to -5 V dc.

Coupling: ac

Impedance: 50 Ω *NOMINAL* (VSWR, < 2.5:1 TYPICAL).

Damage level: ± 8 V (dc + ac peak), fuse protected. Fuse located in BNC connector.

Frequency (channel C)

Range: 50 to 1000 MHz.

LSD displayed: 100 Hz to 1 Hz depending upon gate time. At least 7 digits per second of gate time.

Option 004: High Stability OVEN Time Base (5315A only)

Frequency: 10 MHz

Aging rate: < 3 × 10⁻⁸/mo*

Temperature: ± 1 × 10⁻⁷, 0° to 50°C.

Line voltage: < 1 × 10⁻⁸, for a 10% variation.

Oven will operate continuously off of a fully charged battery for > 24 hours, typically, when in standby mode (no power applied, instrument OFF, and Freq. A button depressed).

(5315B and 5316A)

Frequency: 10 MHz

Aging rate: < 3 × 10⁻⁸/mo.**

Temperature: ± 2 × 10⁻⁸, 0° to 50°C

Line voltage: < 1 × 10⁻⁸, for a 10% variation.

Option 006: Offset-Normalize Module

Measurements (X) operated on: Frequency, Period, Time Interval, Time Interval Delay, Ratio, and Check. Time Interval place holding zeros are not operated upon.

Modes: Normalize (X/A), Offset (X + B), Normalize and Offset ((X/A) + B); switch selectable. Dividing by zero displays zero.

A and B value selection: entered by thumbwheel switch with 8-digit mantissa and 1-digit exponent with sign. B may be positive or negative value.

Display: 999.99999 × 10⁹ to < 1 × 10⁻⁹ range. For negative numbers, the minus sign reduces resolution by one digit.

Overflow: frequency measurements will overflow 3 decades after which LSD will be truncated.

Rack mount kit: 5061-0074 recommended.

Weight: option 006 adds 1.8 kg (4 lbs. 1 oz.) to instrument weight.

Dimensions

5315B plus option 006: 425 mm W x 88 mm H x 345 mm D (16 3/4 x 3 1/2 x 16 1/2")

5316A plus option 006: 425 mm W x 88 mm H x 415 mm D (15 3/4 x 3 1/2 x 16 1/2")

Ordering Information

		5315A	5315B	5316A
Option 001	TCXO Time Base	X	X	X
Option 002	Battery Pack	X		
Option 003	C-Channel (1.0 GHz)	X	X	X
Option 004	High Stability OVEN Time Base	X	X	X
Option 006	Offset-Normalize Module		X	X

All 5315A orders must include one (1) of these line power options:

Option 100: 90-105 VAC

Option 120: 108-126 VAC

Option 220: 198-231 VAC

Option 240: 216-252 VAC

5315A Universal Counter

5315B Universal Counter

5316A Universal Counter

*After 30 days continuous operation (ac power applied, in OFF or ON position).

**After 30 days continuous operation.

< 5 × 10⁻⁸/mo., after 7 days continuous operation.

ELECTRONIC COUNTERS

Low Cost Universal

Model 5314A

301



- 100 MHz
- 100 ns time interval
- Portable

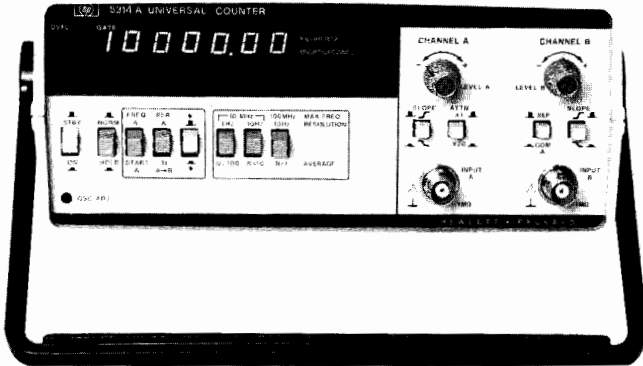

5314A

The 5314A Universal Counter is the newest result of HP's continuing low cost counter product development effort. It combines excellent performance and traditional HP quality at a very attractive price. This counter is designed to deliver reliable, high quality operation in such areas as: Production Test, Frequency Monitoring, Education, Training, Service and Calibration. Additionally, the optional battery (option 002) makes the 5314A especially attractive for field and portable applications.

Input Characteristics (channels A and B)

Range: CHANNEL A: 10 Hz to 10 MHz Direct.

1 MHz to 100 MHz Prescaled.

CHANNEL B: 10 Hz to 2.5 MHz.

Sensitivity: CHANNEL A: 25 mv rms to 100 MHz.

75 mv peak-to-peak at minimum pulse width of 5 ns (100 MHz range).

CHANNEL B: 25 mv rms to 2.5 MHz.

75 mv peak-to-peak at minimum pulse width of 200 ns.

Coupling: ac

Impedance: 1 M Ω NOMINAL shunted by less than 30 pf.

Attenuator: X1 or X20 NOMINAL (A channel only).

Trigger level: continuously variable \pm 350 mV times attenuator setting around average value of signal.

Slope: independent selection of + or - slope.

Channel input: selectable SEPARATE OR COMMON A.

Dynamic range: 75 mV p-p to 4 V p-p.

Frequency

Range: 10 Hz to 10 MHz direct count.

10 Hz to 100 MHz prescaled by 10.

Least significant digit (LSD) displayed: direct count 0.1 Hz, 1 Hz, 10 Hz switch selectable. Prescaled 10 Hz, 100 Hz, 1 KHz switch selectable.

Resolution: \pm LSD.

Accuracy: \pm LSD \pm (time base error) x Freq.

Period

Range: 10 Hz to 2.5 MHz.

LSD displayed: $\frac{100 \text{ ns}}{N}$ for N=1 to 1000 in decade steps of N.

Resolution: \pm LSD $\pm \frac{(1.4x \text{ TRIGGER ERROR})}{N}$

Accuracy: \pm LSD $\pm \frac{(1.4x \text{ TRIGGER ERROR})}{N}$

\pm (time base error) x Per.

Time Interval

Range: 250 ns to 1 s.

LSD displayed: 100 ns.

Resolution: \pm LSD \pm START trigger error \pm STOP trigger error.

Accuracy: \pm LSD \pm START trigger error

\pm STOP trigger error \pm (time base error) x TI.

External arming required for START/STOP channels.

Ratio

Range: 10 Hz to 10 MHz CHANNEL A.

10 Hz to 2.5 MHz CHANNEL B.

LSD displayed: 1/N in decade steps of N for N = 1 to 1000.

Resolution: \pm LSD \pm (B trigger error x Frequency A)/N.

Accuracy: \pm LSD \pm (B trigger error x Frequency A)/N.

Totalize

Range: 10 Hz to 10 MHz.

Resolution: \pm 1 count of input.

Totalize controlled by front panel switch.

General

Check: counts internal 10 MHz oscillator.

Display: 7 digit amber LED display with gate and overflow indication.

Max sample rate: 5 readings per second.

Operating temperature: 0 $^{\circ}$ to 50 $^{\circ}$ C.

Power requirement: 115, +10%, -25%; 230 V, +9%, -17%; 48-66 Hz; 10 VA max.

Weight: 2.0 kg (4.4 lb.).

Dimension: 238 mm W x 98 mm H x 276 mm D (9 $\frac{3}{8}$ " x 3 $\frac{7}{8}$ " x 10 $\frac{7}{8}$ ").

Time Base

Frequency: 10 MHz.

Aging rate: < 3 part in 10⁷ per month.

Temperature: < \pm 10 parts in 10⁶, 0 to 50 $^{\circ}$ C.

Line voltage: < \pm 1 part in 10⁷ for \pm 10% variation.

Options

Option 001 TCXO

Frequency: 10 MHz.

Aging rate: < 1 part in 10⁷ per month.

Temperature: < \pm 1 part in 10⁶, 0 to 40 $^{\circ}$ C.

Line voltage: < \pm 1 part in 10⁸ for \pm 10% variation.

Option 002 battery

Type: rechargeable lead-acid (sealed).

Capacity: typically 8 hours of continuous operation at 25 $^{\circ}$ C.

Recharging time: typically 16 hours to 98% of full charge, instrument non-operating. Charging circuitry included with option. Batteries not charged during instrument operation.

Battery voltage sensor: automatically shuts instrument off when low battery condition exists.

Line failure protection: instrument automatically switches to batteries in case of line failure.

Weight: option 002 adds typically 1.5 kg (3.3 lb.) to weight of instrument.

Definitions

Resolution: smallest discernible change of measurement result due to a minimum change in the input.

Accuracy: deviation from the actual value as fixed by universally accepted standards of frequency and time.

Trigger error:
$$\frac{\sqrt{(80\mu\text{V})^2 + e_n^2}}{\text{input slew rate at trigger point } (\mu\text{V/s})} \text{ (rms)}$$

Where e_n is the RMS noise of the input for a 100 MHz bandwidth in CHANNEL A and 10 MHz bandwidth in CHANNEL B.

Options

001 High Stability Time Base

002 Battery

All orders must include one (1) of these line power options:

115: 86-127 V

230: 190-250 V

5314A 100 MHz / 100 ns Universal Counter



ELECTRONIC COUNTERS

Low Cost Counters For Frequency Measurements

Models 5384A, 5385A

- Rackable
- Stackable
- Portable

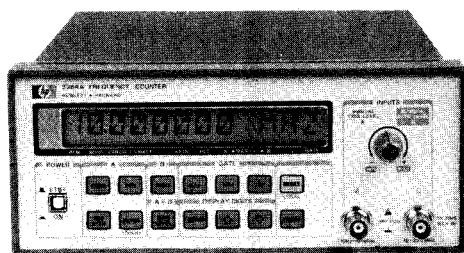

5384A 225 MHz

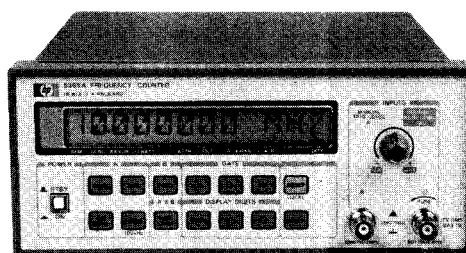

5385A 1.0 GHz



Description

The 5384A and 5385A are HP's lowest priced system counters. They provide outstanding measurement performance for bench, field, and system applications. The combination of wide frequency range, high resolution, high sensitivity, and HP-IB or HP-IL compatibility, puts the 5384A and 5385A in a class with instruments costing much more. The added feature of remote display extends the usefulness of these counters beyond that of simply making and displaying frequency measurements. User friendly messages, prompts, and measurement units can now be displayed.

Specifications

Input channel A (5384A/85A): 1M ohm // 25pF

Range: 10 Hz to 100 MHz

Sensitivity: 15 mVrms sine wave 50 Hz to 100 MHz
25 mVrms sine wave 10 Hz to 50 Hz
45 mV pk-pk 5ns minimum pulse width

Dynamic range: 45 mV to 1 V pk-pk X attenuator setting

Attenuator: X1 or X20 nominal above 50 Hz input

Low pass filter: 100 kHz nominal 3 dB point

Manual trigger level: variable, -0.1 V to +0.1 V x attenuator

Damage level X1: 10-200 Hz 350 V (DC + AC peak)
0.2-420 kHz 170 V (DC + AC peak)
0.42-10 MHz (5 x 10⁻⁷ Vrms Hz)/FREQ
>10 MHz 5 Vrms

X20: < 1 MHz, Same as X1; > 1MHz, 50 Vrms

Input channel B (5384A): 50 ohm

Range: 50 to 225 MHz

Sensitivity: 10 mVrms 50 to 200 MHz; 15 mVrms 200 to 225 MHz

Dynamic range: 10 mV to 1 Vrms

Manual attenuator: variable, X1 to X5 (0 to 14dB) nominal

Damage level: 350 V dc + 5 Vrms ac

Input channel B (5385A): 50 ohm, fused

Range: 90 to 1000 MHz

Sensitivity: 10 mVrms (-27 dBm)

Dynamic range: 10 mV to 7 Vrms (-27 to +30 dBm)

Manual attenuator: variable, X1 to X18 (0 to 25 db) nominal

Damage level: ac > 1 MHz +30 dBm (7 Vrms)
ac < 1 MHz 2 Vrms, DC ± 5 V

Frequency A and B

Range channel A: 10 Hz-100 MHz

Range channel B: (5384A) 50 MHz-225 MHz,
(5385A) 90-1.0 GHz

LSD displayed: 10 Hz to 1 nHz

Period A

Range: 10 ns to 0.1 s

LSD displayed: .001 fs to 10 ns

Timebase: 10 MHz

Standard 5384A

Aging rate: < 3 x 10⁻⁷/mo.

Temperature: < 5 x 10⁻⁶, 0° to 50° C, ref. 25° C

Line voltage: < 1 x 10⁻⁷ for ± 10% variation.

TCXO (5385A), Option 001 (5384A)

Aging rate: < 1 x 10⁻⁷/mo.

Temperature: < 1 x 10⁻⁶, 0° to 40° C, ref. 25° C

Line voltage: < 5 x 10⁻⁸ for ± 10% variation.

I/O Interface

HP-IB Standard, HP-IL Options 002 & 003

Programmable functions: Frequency A, Frequency B, Period A
Programmable controls: ATTN A, FILTER A, MAN LEVEL A/B, GATE

Display: Normal, Increment, Decrement, Remote, Local

Data output: output will be maximum resolution/gate time

Format: 17 characters plus CR and LF

Rate: 4 readings/sec maximum at .1 sec gate

Battery Pack (Option 002)

Battery type: sealed lead-acid

Capacity: 4 hours(typ.) at 25°C without option 004.

Recharge time: 16 hours (typ.) in the standby mode.

Battery low annunciator: enabled 20 minutes prior to instrument shutdown nominally.

Battery save switch (rear panel): prevents discharge of internal battery by the oven timebase, option 004, during instrument standby (STBY).

Line failure protection: instrument automatically switches to battery in case of line failure.

Weight: option 002 adds 1.4 kg.(3 lbs.) to instrument weight.

Oven Timebase (Option 004)

Aging rate: < 3 x 10⁻⁸/mo. after 30 days continuous operation.

Temperature: < 1 x 10⁻⁷, 0° to 50° C, ref. 25° C

Line voltage: < 5 x 10⁻⁸ for ± 10% variation.

Battery operation: the instrument operates for 3 hours (typ.) with option 004. In STBY, the oven will operate continuously for 24 hours (typ.).

General

Check: 10 MHz self-test

Gate times: 0.1, 1, or 10 seconds (nominal).

Display: 12-digit alphanumeric liquid crystal.

Display digits (variable): frequency 3 to 11; period 3 to 8.

Timebase output: 10 MHz, 25 mV pk-pk (nom.) into 50 ohms.

External timebase input: 10 MHz, .5 Vrms into 500 ohms.

Operating temperature: 0° to 50° C

Power Requirements

AC: selectable, 18 VA max. 115 V + 10%, -25%

230 V + 10%, -15% 48-66 Hz

115 V ± 10%, 380-420 Hz

DC: 9-15 V DC 1.0 A maximum

Weight: net, 2.2 kg. (4.8 lbs.). Shipping, 4.1 kg. (9 lbs.)

Dimensions: 238mm W x 98mm H x 276mm D (9 3/8 x 3 7/8 x 13 1/8 in.)

Options and Accessories

001 High Stability TCXO (5384A)*

002 HP-IL I/O with Battery Pack**

003 HP-IL I/O**

004 High Stability Ovenized Timebase

910 Additional Operating/Service Manual

5061-1171 Side Handle Kit

5060-0173 Rack Mount Kit (single)

5060-0174 Rack Mount Kit (dual)

34110A Vinyl Carrying/Operating Case

*TCXO timebase is standard with 5385A

**Option 002 and option 003 delete the HP-IB I/O interface.

5384A Frequency Counter 225 MHz

5385A Frequency Counter 1.0 GHz

ELECTRONIC COUNTERS

Low Cost Counters for Frequency Measurements

Models 5381A, 5382A & 5383A

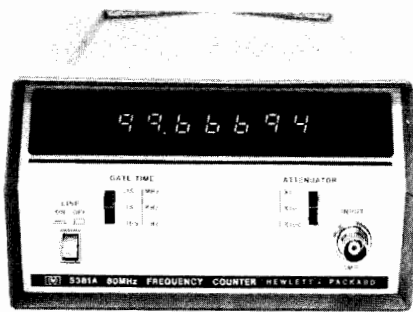

5381A

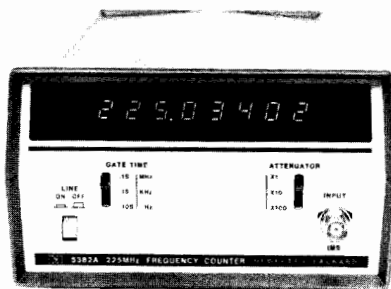

5382A

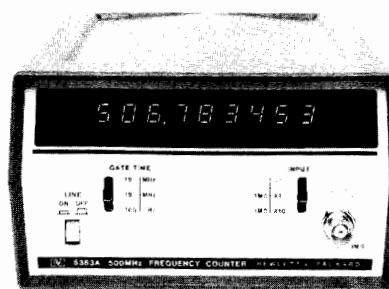

5383A

Description

General

The 5381A, 5382A and 5383A are a logical result of HP's long-standing leadership in frequency counter development. Leadership in quality, technology and efficient production procedures allows HP to offer a superb price/performance combination in these three precision instruments. These counters are designed to deliver reliable, high quality operation in such diverse areas as: production line testing, service and calibration (two-way radio and test equipment), frequency monitoring, education and training.

Resolution

The 5381A, 5382A and 5383A employ the direct counting technique and, with 7, 8 and 9 digits respectively, offer resolution of 10 Hz in 0.1 s., 1 Hz in 1 sec and 0.1 Hz in 10 seconds.

Specifications

5381A

Frequency range: 10 Hz to 80 MHz.

Sensitivity: 25 mV rms—30 Hz to 20 MHz.
50 mV rms—10 Hz to 80 MHz.

Input impedance: 1 M Ω , <50 pF.

Input attenuation: X1, X10, X100.

Accuracy: ± 1 count \pm time base error.

Resolution: direct count; 1 Hz in 1 second.

Gate times: 0.1 second, 1 second, 10 seconds.

Display: 7 LED digits.

Rear panel input: sensitivity, TTL levels or 2.5 V rms.

Ratio: Rear Panel Input, 10 kHz to 2 MHz.

External frequency standard: Rear Panel Input, 1 MHz.

Time Base

Frequency: 1 MHz.

Aging: <0.3 ppm/month.

Temperature: ± 10 ppm 0°C to 40°C.

Line voltage: ± 1 ppm for 10% line change.

5382A

Frequency range: 10 Hz to 225 MHz.

Sensitivity: 25 mV rms—30 Hz to 10 MHz.
50 mV rms—10 Hz to 225 MHz.

Input impedance: 1 M Ω , <40 pF.

Input attenuation: X1, X10, X100.

Accuracy: ± 1 count \pm time base error.

Resolution: direct count; 1 Hz in 1 second.

Gate time: 0.1 second, 1 second, 10 seconds.

Display: 8 LED digits, nonsignificant zero blanking.

Rear panel input: sensitivity, 250 mV rms.

Ratio: Rear Panel Input, 100 kHz to 10 MHz.

External frequency standard: Rear Panel Input, 10 MHz.

Time Base

Frequency: 10 MHz.

Aging: <0.3 ppm/month.

Temperature: ± 2.5 ppm 0°C to 40°C.

Line voltage: ± 0.5 ppm for 10% line change.

5383A

Frequency range: 10 Hz to 520 MHz.

Sensitivity:

1 M Ω : 25 mV rms—20 Hz to 10 MHz.

50 mV rms—10 Hz to 50 MHz.

50 Ω : 25 mV rms—20 Hz to 520 MHz.

Input impedance: selectable: 1 M Ω , <40 pF or 50 Ω .

Input attenuation: 1 M Ω \times 1, \times 10; 50 Ω \times 1—fuse protected.

Accuracy: ± 1 count \pm time base error.

Resolution: direct count; 1 Hz in 1 second.

Gate time: 0.1 second, 1 second, 10 seconds.

Display: 9 LED digits, nonsignificant zero blanking.

Display test: RESET function (activated with GATE TIME switch) illuminates all segments of all digits.

Rear panel input: sensitivity: 250 mV rms.

Ratio: Rear Panel Input, 100 kHz to 10 MHz.

External frequency standard: Rear Panel Input, 10 MHz.

Time Base Output

Frequency: 10 MHz.

Voltage: 200 mV p-p into 50 Ω load.

Control: active with Rear Panel Internal/External switch in internal position.

Time Base

Frequency: 10 MHz.

Aging: <0.3 ppm/month.

Temperature: ± 2.5 ppm 0°C to 40°C.

Line voltage: ± 0.5 ppm for $\pm 10\%$ line change.

TCXO Option

Opt 001: (available for all models) Temperature Compensated Crystal Oscillator time base

Frequency: 10 MHz.

Aging: <0.1 ppm/month.

Temperature: <1 ppm 0°C to 40°C.

Line voltage: ± 0.1 ppm for $\pm 10\%$ line change.

Note: time base output available for both 5382A and 5383A with Option 001.

5380 Family General Data

Overflow: LED lamp indicator when most significant digit overflows.

Reset: manual selection of reset occurs when GATE TIME switch is between three normal positions.

Package: rugged, high strength metal case.

Operating temperature: 0°C to 40°C.

Power requirements: 100, 120, 220, 240, V rms (+5%, -10%) 48-440 Hz; 30 VA maximum.

Weight: net, 2.2 kg (4 $\frac{1}{2}$ lb). Shipping, 2.8 kg (6 lb).

Dimensions: 98 H x 60 W x 248 mm D (3.5" x 6.25" x 9.75").

Ordering Information

5381A Frequency Counter

5382A Frequency Counter

5383A Frequency Counter

Opt 001: TCXO (all models)

ELECTRONIC COUNTERS

Plug-On Modular/Portable Counter System

Model 5300 A/B System & 5301A-5312A

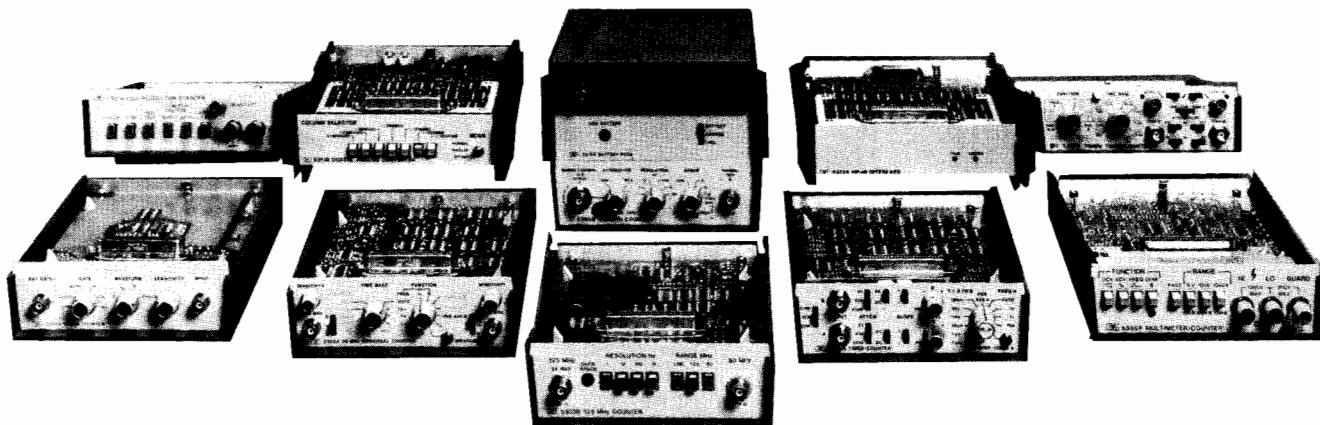

5300 Measuring System

The 5300 measurement system will not be available after March 1, 1984. However, the measurement performance and applications capability of that plug-on modular/portable counter system is either met or exceeded by newer HP products. Below is a replacement guide/table of current counters that are recommended as substitutes for each 5300A/B module based on function and/or performance.

Replacement Guide

5300 Module	Primary Functions	Recommended Substitute
5300A Mainframe	—	—
5300B Mainframe	—	—
5301A 10 MHz Counter	Frequency, Totalize	5314A
5302A 50 MHz Counter	Universal	5314A
5303B 500 MHz Counter	Frequency	5383A, 5385A
5304A 10 MHz Timer/Counter	Frequency, Time Interval	5314A
5305B 1300 MHz Counter	1.3 GHz Frequency	5334A/35A Opt 30
5306A Multimeter/Counter	DVM Option	5334A/35A Opt 20
5307A High Resolution Counter	Low Frequency, High Resolution	5384A
5308A 75 MHz Universal Counter	Universal, Time Interval Average	5315A/B
5310A Battery Pack	Internal Battery Option	5314A/15A Opt 002 5384A/85A Opt 002
5311B Digital-to-Analog Converter	DAC	59303A
5312A HP-IB (ASCII) Interface	I/O Capability	5316A, 5384A/85A



Signal sources are described by various names; oscillators, audio signal generators, synthesizers, function generators, etc. The names are typically associated with the application area. A Signal generator is an oscillator which has modulation capability. Synthesizers are sine wave sources generated digitally, using a process known as "fractional N", which gives them excellent frequency stability. The term oscillator refers exclusively to a sinusoidal source while a function generator always provides additional wave shapes, most often square waves, triangle waves, and increasingly, arbitrary waveforms.

Technological progress has lowered the cost of digitally derived sources. Hence, synthesizers are increasingly being used in place of oscillators. Synthesizers offer the user two important benefits; the ability to digitally enter frequency very precisely, and extremely stable frequency output. In addition, function generators and arbitrary waveform generators are becoming digitally derived, which has tended to blur the traditional definitions of these products.

In this section, we are considering oscillators covering the audio through video frequency range.

Basic Considerations

In choosing a particular oscillator, frequency range, output level and distortion are the key considerations. Typically, oscillators used for testing of audio equipment, filters, amplifiers, etc., require total harmonic distortion (THD) to be less than 65 dB. Oscillators used in video testing must provide signals to at least 6 MHz and often to 10 MHz. For many general purpose applications, high level signals are needed. Hewlett-Packard offers oscillators that meet these requirements.

Distortion

Distortion in total harmonic terms is a measure of the oscillator's signal purity. It is presented as a ratio of the total harmonic content to the fundamental and expressed either as dB's below the fundamental or as a percentage of it. A typical "good" value might be a THD of -60 dB (0.1%), although -95 dB is becoming necessary, especially in the audio entertainment and Hi-Fi areas. Hewlett-Packard offers this high level of signal purity in the integrated oscillator of the 339A Distortion Measurement Set.

Frequency Stability

Frequency stability of an oscillator determines the ability of the instrument to maintain a selected frequency over a period of time. Component aging, power-supply variations and temperature changes all affect stability. Carefully chosen components, such

as precision resistors and variable capacitors in the frequency-determining networks, contribute to long-term stability. Technology, particularly large scale integration, minimizes the adverse effects of temperature and in such situations all but eliminates the effects of discrete component aging.

Amplitude Stability

Amplitude stability with time and over a desired frequency range is an important characteristic in most applications. Hewlett-Packard uses negative feedback techniques to minimize variations in amplitude with time and pays great attention to circuit elements that influence the frequency response of the oscillator.

Source Summary

Type	Model	Frequency Range												Page	
Oscillators (page 306)	200CD														306
	204C														306
	204D														306
	209A														306
	654A														306
Function Generators (page 324)	3310A/B														324
	3311A														325
	3312A														326
	3314A														326
Pulse/ Function Generator	8111A														327-329
	8116A														
Synthesizer/ Function Generator	3325A														334-335
	8165A														
Synthesizer/ Level Generator	3335A														336
	3336A/B/C														

1μHz .01mHz .1mHz 1mHz .01Hz .1Hz 1Hz 10Hz 100Hz 1KHz 10KHz 100KHz 1MHz 10MHz 100MHz

OSCILLATORS

4 Hz to 10 MHz Oscillators

Models 200CD 204C 204D 209A 654A

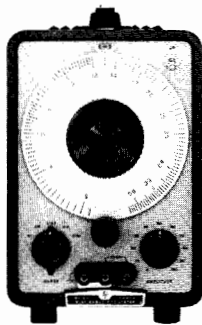

200CD

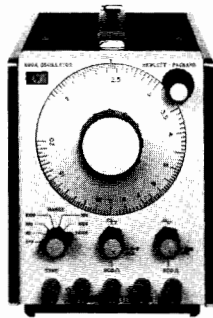

209A (shown), 204C, 204D

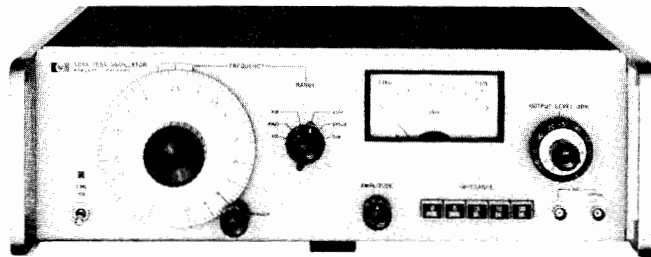

654A

Specifications

	200CD	204C,D	209A	654A
frequency range	5 Hz. to 600 KHz.	5 Hz. to 1.2 MHz.	4 Hz. to 2 MHz.	10 Hz to 10 MHz
number of ranges	5 overlapping	6 overlapping	6 overlapping	
dial accuracy	± 2%	± 3%		± 2%, 100 Hz to 5 MHz, ± 3%, 10 Hz to 100 Hz, ± 4%, 5 MHz to 10 MHz
flatness (1 KHz. ref.)	± 1 dB.	(Low Distortion mode) ± 1% 5 Hz to 100 Hz ± .5% 100 Hz to 300 KHz ± 1% 300 KHz to 1.2 MHz (Normal mode) as above, except: +5%, -1% 5 Hz to 100 Hz		(± 10 dbm and 0 dbm, 1 kHz ref.) ± 0.5% for: 10 Hz to 10 MHz for unbalanced outputs 10 Hz to 5 MHz for 135 Ω and 150 Ω outputs, 10 Hz to 1 MHz for 600 Ω output
output voltage (600 ohm load) (open circuit)	10 V rms (> 160 mW.) 20 V rms	> 2.5 V rms (10 mW.) > 5.0 V rms	5 V rms (40 mW.) 10 V rms	+11 dbm to -90 dbm, 10 db and 1 db steps
output impedance	600 ohms	600 ohms		50, 75 Ω unbal; 135 Ω, 150 Ω, 600 Ω balanced
attenuator	continuously variable	(204C) continuously variable, >40 dB. range (204D) +10 to -70 dBm in 10 dB steps plus vernier. Accuracy is ± 0.3 dB through -60 dBm range, ± 0.5 dB through -70 dBm range.	continuously variable, >26 dB. range	99 db range in 10 db and 1 db steps with ± 0.13 db (± 1.5%) accuracy except ± 1 db (± 10%) at levels below 60 dbm at frequencies >300 KHz
distortion	<.5% 5 Hz to 20 Hz <.2% 20 Hz to 200 KHz <.5% 200 KHz to 600 KHz	<.6% 5 Hz to 30 Hz <.1% 30 Hz to 100 KHz <.1% 100 KHz to 1.2 MHz	<.2% 4 Hz to 200 Hz <.1% 200 Hz to 200 KHz 1% 200 KHz to 2 MHz	10 Hz to 1 MHz, <40 db (1%) 1 MHz to 10 MHz, <34 db (2%)
hum and noise voltage	<.1% of rated output	<.01% of output		<70 db (.003%) of rated output
balance	<.1% at lower frequencies approx. 1% at higher frequencies	>40 dB below 20 KHz		>50 db 10 Hz to 1 MHz >40 db 1 MHz to 10 MHz
square wave output		20 V p-p open circuit symmetrical about 0 V.		
rise/fall time		<50 nSec into 600 ohms		
synchronization input		oscillator can be synchronized to an external signal. Sync range, the difference between sync frequency and set frequency, is a linear function of sync voltage. ± 1%/V rms for sine wave, maximum input ± 7 V pk (± 5 V rms).		
synchronization output		sine wave in phase with output; fixed level: 204C,D: 100mV into 10 Kohms, 100 pF 209A: 1.7 V rms (open circuit)		
input voltage	115 or 230 VAC ± 10% 48-440 Hz.			
power consumption	90 VA	7 VA		35 VA
net weight	9.9 kg (22 lb)	2.7 kg (6 lb)		9.4 kg (21 lb)
shipping weight	10.8 kg (24 lb)	3.6 kg (8 lb)		11.8 kg (26 lb)
dimensions H x W x D	292 mm x 187 mm x 365 mm 11.5 x 7.4 x 14.4"	155 mm (without removeable feet) x 130 mm x 203 mm (6.1 x 5.1 x 8")		133 mm H x 425 mm W x 337D (5.21" x 16.75" x 13.25")
options	option 002 - operation from AC line or internal rechargeable batteries			

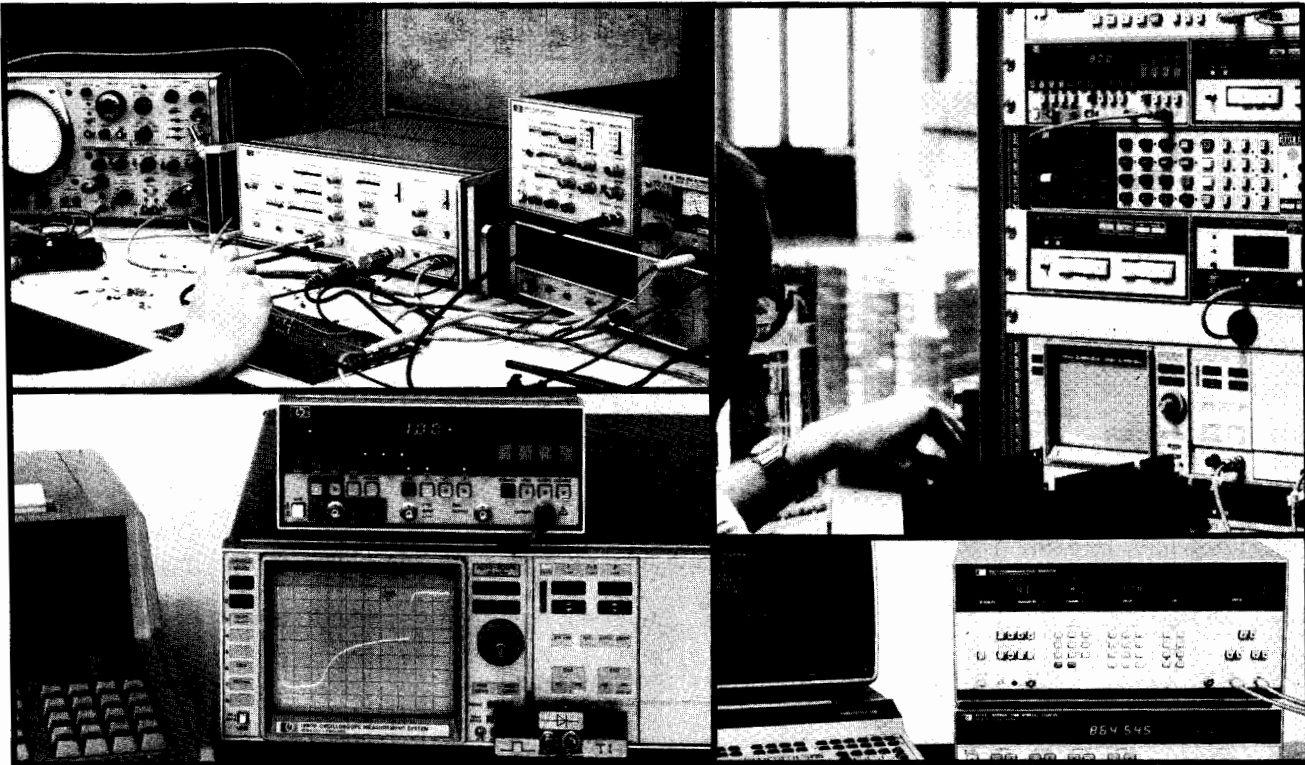

Analog and Digital Test

HP's *pulse generators* range from simple, inexpensive units to high performance, microprocessor-based instruments offering precision pulse generation. Depending on model, variable clock speeds to 1 GHz and variable amplitudes up to 100 V are available.

Pulse parameters are independently variable for thorough characterization and worst-case testing. Variable pulse transitions permit parametric analysis like trigger circuit hysteresis, and the fastest settings are ideal for at-speed logic test and amplifier transient investigations.

Pulse/function generators combine pulse capability with all features expected of a function generator. The benefits are high flexibility for analog requirements plus an entry into logic test.

Operating Comfort

Clear front panel layout, guided parameter selection, and error detection and recovery features, mean quick familiarization and rapid, error-free use. In addition, great emphasis is placed on ruggedness, reliability and serviceability. The generators are developed and produced using high quality standard components and custom-designed ICs. Resultant technical benefits are, for exam-

ple, broad operating temperature range and clean 50-Ohm output impedance.

Selectable polarity, complement and offset help make hook-up simpler and, for further flexibility, *inverters, adders and splitters* are available (page 320).

Complex waveform capability allows glitches, ringing and multi-level signals to be simulated. Constant numbers of pulses, unaffected by other parameters are available in HP's counted burst mode.

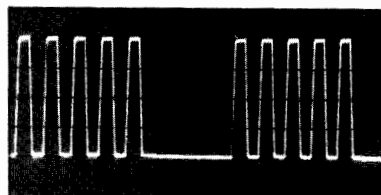

Bench and Automatic Test

A new generation of very versatile models offer good repeatability and high operating comfort for fast, accurate testing. These instruments also offer HP-IB which makes bench automation a reality for time-consuming tests. Setup time is a minimum because the syntax is simple and uses the same command sequence as the front panel.

Straight-forward syntax helps develop ATS software quickly; good repeatability and error reporting eliminate the need for software measurement loops. Specified performance over the entire 0°C to 55°C operating temperature range guarantees reliability in system racks.

Time Synthesis (page 321)

Time Synthesizers are mainly used in radar and laser ranging, component and circuit testing, and precise triggering and calibrating applications. They give a precisely timed output pulse with an accurate, adjustable delay which may be incremented in steps as small as 50 pico-seconds. A fixed, virtually jitter-free insertion delay allows phase locking to equipment under test.

Logic Capability

CMOS: 8011A, 8015A, 8111A, 8112A, 8116A, 8160A

TTL: 8012B, 8013B, 8015A, 8111A, 8112A, 8116A, 8160A.

S-TTL: 8007B, 8082A, 8161A

ECL: 8082A (0.7 ns), 8080A (0.5 ns/0.2 ns, depending on configuration), 8161A (0.9 ns). Figures in brackets are the equivalent ECL switching time, 20% to 80% of amplitude.

Pulse Generator Selection Chart

Page	Pulse Generators										Pulse/Function Generators				
	214B 309	8005B 315	8011A 315	8012B 316	8013B 316	8015A 317	8007B 318	8082A 319	8080A 320	HP-IB 8112A 310	HP-IB 8160A 312	HP-IB 8161A 312	HP-IB 8111A 330	HP-IB 8116A 331	HP-IB 8165A 333
Timing															
Max frequency (MHz)	10	20	20	50	50	50	100	250	300/1000	50	50	100	20	50	50
Transition time (ns)	15	10 var	10	5 var	3.5	6 var	2 var	1 var	0.8/0.3	5 var	6 var	1.3 var	10	6	5
Var width (ns) min	25	25	25	10	10	10	5	2	Sp Opt	10	10	4	25	10	10
Square/duty cycle (%)	1-10	Sq	Sq	Sq	Sq	Sq	Sq	Sq	Sq	1-99			10-90	10-90	20/50/80
Variable delay	*	*		*	*	*	*	*	*	*	*	*			
Output (max values are quoted: see specifications for conditions).															
Amplitude (V)	100	10	16	10	10	30	10	5	4/2.4	32	20	5	32	32	20
Offset/Window (V)		$\pm 4/\pm 10$		$\pm 2.5/\pm 7.5$	$\pm 2.5/\pm 7.5$	$\pm 28/\pm 16$	$\pm 8/\pm 18$	$\pm 2/\pm 5$	$\pm 2/\pm 4$	$\pm 16/\pm 16$	$\pm 20/\pm 20$	$\pm 5/\pm 5$	$\pm 16/\pm 16$	$\pm 16/\pm 16$	$\pm 10/\pm 10$
Format	+/-	*	*	*	*	*	*	*	*	*	*	*	*	*	*
* = positive, negative, symmetrical, normal and complement formats.															
Outputs	1	+ and -	1	1	+ and -	2	1	1	Configurable	1	2-chan option	2-chan option	1	1	1
Additional outputs		TTL				TTL		Compl				Compl			
Operating Modes															
Trigger	*	*	*	*	*	*	*	*	*	*	*	*	*	*	*
Ext width				*	*	*	*	*	*	*	*	*	*	*	*
Gate	*	*	*	*	*	*	*	*	*	*	*	*	*	*	*
Ext burst	Option		Option			Option				*	*	*	Option	Option	*
Int burst										*	*	*		Option	
Double pulse	*	*		*	*	*	*	*	*	*	*	*			
Control (Modulation) Modes										*	*	*	*	*	*

Pulse Generator Definitions

Time Reference Point: Median (50 % amplitude point on pulse edge).
Pulse Period: The time interval between the leading edge medians of consecutive trigger output pulses.
Trigger Delay: Interval between trigger point of input signal and the trigger output pulse's leading edge median. Applies in trigger, external width, gate and burst modes.

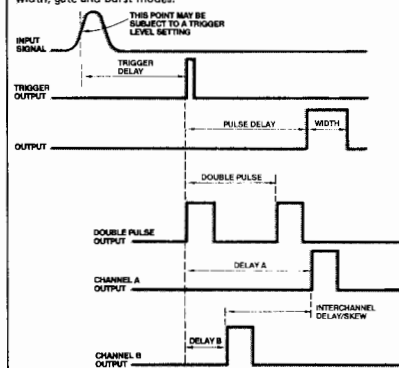

Pulse Delay: Interval between leading edge medians of trigger output pulse and output pulse.
Double Pulse: Interval between leading edge medians of the double pulse.
Interchannel Delay/Skew: Interval between corresponding leading edge medians.
Pulse Width: Interval between leading- and trailing-edge medians.

Additional Information for Pulse Generators with Variable Transition Times

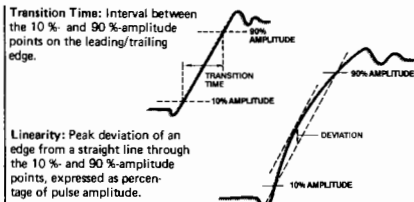
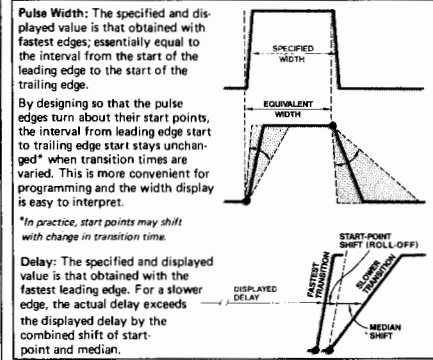

Jitter: Short-term instability of one event with respect to another. Unless stated otherwise, value is p-p, expressed as a percentage of the main parameter.

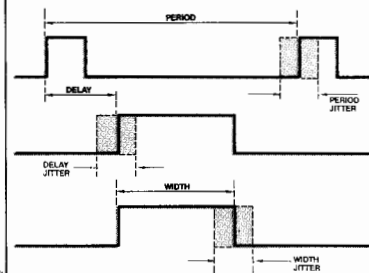

Stability: Long-term average instability, expressed as percentage of main parameter over a specific time duration, e.g. hour, year. Excludes jitter.

Pulse Level: High level and low level. Any limitation is expressed by an amplitude specification.

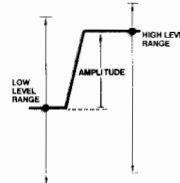

Pulse Amplitude (alternative to level definition): Pulse amplitude and offset* are specified. Any limitation is expressed by a window (max high level, min low level).

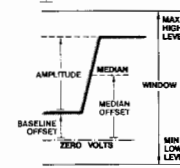

*Pulse generators use baseline offset. Function generator outputs are symmetrical and consequently use median offset.

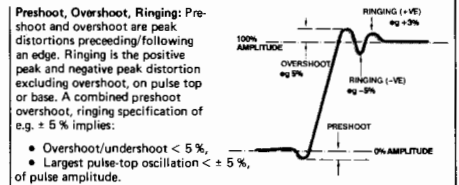

Settling Time: Time taken for pulse levels to settle within level specification, measured from 90 % point on leading edge.

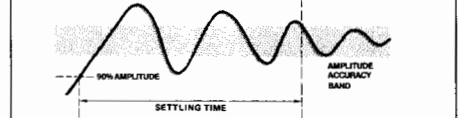

Duty Cycle: Percentage ratio of pulse width to period. In pulse/function generators, this term is also used to define sine and triangle symmetry.

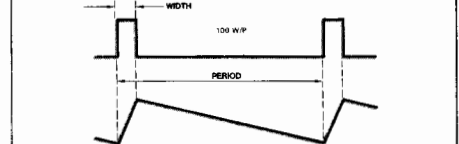

Output Impedance/Resistance: Effective pulse source impedance/dc resistance.
Reflection Coefficient: Reflection at pulse generator output expressed in percent of incident pulse amplitude. (Test pulse edges correspond to generator's fastest transitions).

Repeatability: When an instrument operates under the same environmental conditions, and with the same settings, the value of a parameter will lie within a band inside the accuracy window. Repeatability defines the width of this band.

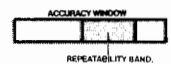

HP-IB Programming Times

Listen Time: The time an instrument occupies the bus to receive and verify a message. The NRFD signal is active during this period.
Setting Time: The time taken by the instrument to execute an HP-IB message, and for the output to settle within the accuracy specification. NRFD inactive.
Execution Time: The sum of Listen Time and Settling Time.
Talk Time: The time an instrument occupies the bus to output a specified string. Output data is typically instrument error status, or current or stored parameters.

PULSE GENERATORS

Fast, High Power Pulse Generator

Model 214B



- High power 100 V, 2 A output
- 10 MHz repetition rate

- Constant duty cycle
- Counted pulse burst option

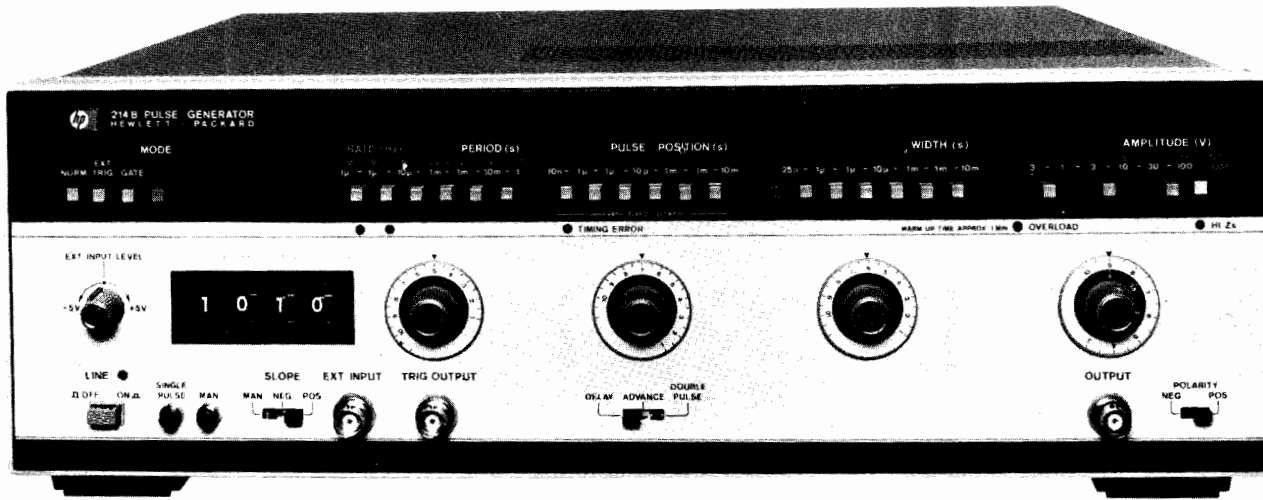

Picture shows 214B with Option 001, Counted Burst.

The HP 214B pulse generator employs semiconductor technology for high power pulse generation at up to 10 MHz repetition rate. Delivering 100 V pulses with 15 ns risetimes, the 214B meets the speed demands of today's applications.

State-of-the-art VMOS FETS used as current sources for the output amplifier tubes enable pulse width to be specified down to 25 ns. The 214B is thus well-equipped for low duty cycle applications such as laser diode pulsing or transient simulation.

Where changing duty cycle threatens destruction to the device under test, the 214B Constant Duty Cycle (CDC) mode provides device protection. In CDC operation the duty cycle, hence power, remains constant as frequency is varied. The 214B is itself protected against excessive duty cycles via an overload protect circuit.

Easy operation is assured by the timing error indication. Calibrated dials enable fast accurate adjustments. Operating into unmatched loads, clean pulse shape is guaranteed by the low reactance 50 Ω source impedance. Pulse distortions such as preshoot and overshoot are specified as 5% at all amplitudes.

Specifications

Timing

Repetition rate: 10 Hz to 10 MHz in 6 ranges. In 30 V - 100 V amplitude range, maximum rep. rate is 4 MHz. Calibrated vernier provides continuous adjustment within ranges. **Vernier accuracy:** $\pm(10\%$ of setting + 1% full scale). **Period Jitter:** $\leq 0.1\% + 300$ ps.

Pulse delay/advance: pulse can be delayed/advanced with respect to the trigger output from 10 ns to 10 ms (\pm fixed delay of 45 ns) in 5 ranges. Calibrated vernier provides continuous adjustment within ranges. **Vernier accuracy:** $\pm(10\%$ of setting + 1% full scale) + fixed delay. **Position Jitter:** $\leq 0.1\% + 500$ ps

Maximum pulse position duty cycle: $\geq 50\%$

Double pulse: 5 MHz maximum in all ranges except 30 V - 100 V range which is max. 2 MHz. Minimum separation is 100 ns.

Pulse width: 25 ns to 10 ms in 6 decade ranges. Calibrated vernier provides continuous adjustment within ranges. **Accuracy:** $\pm(10\%$ of setting + 1% full scale) + 5 ns. **Width Jitter:** $\leq 0.1\% + 500$ ps.

Max. duty cycle: $\geq 10\%$ for 30 - 100 V range. $\geq 50\%$ all other ranges.

Constant duty cycle mode (disabled in ext. trigger mode): duty cycle of output pulse remains constant as the period is varied. The duty cycle limits in this mode are typically 8% fixed for the 10 M - 1 MHz range (max. 4 MHz); 2.5% to 10% for 1 MHz - .1 MHz range; .25% to 10% for .1 MHz - 10 kHz range; 0.1% for all other ranges. Calibrated vernier provides continuous adjustment within ranges.

Accuracy: $\pm(15\%$ of setting + 1% of full scale).

Trigger Output

Amplitude: ≥ 5 V (50 ohm into open circuit).

Pulse width: 10 ns typical.

External Operating Modes

External input (impedance 10 k ohm, dc coupled)

Repetition rate: dc to 10 MHz. **Sensitivity:** 500 mVpp, dc coupled.

Slope: pos. or neg. **Trigger level:** +5 V to -5 V adjustable.

Maximum input level: ± 100 V. **Trigger pulse width:** ≥ 10 ns.

EXT TRIG mode: an output pulse is generated for each input pulse.

GATE mode: gate signal turns on rep. rate generator synchronously. Last pulse always completed.

BURST mode (optional): preselected number of pulses generated on receipt of trigger signal. **Number of pulses:** 1 to 9999. Minimum spacing between bursts: 200 ns.

Manual: pushbutton can be used for triggering single pulses (EXT TRIG mode), generating gate signals (GATE mode) or triggering pulse bursts (BURST mode).

Output

Amplitude: 0.3 V to 100 V in 5 ranges. Calibrated vernier provides adjustment within ranges. **Vernier accuracy:** $\pm 10\%$ of setting.

Source impedance: fixed 50 Ω nominal on ranges up to 10 V. Selectable 50 Ω nominal or HI-Z on 10 - 30 - 100 V ranges (with 50 Ω / 50 Ω impedance, amplitude decreases to 5 - 15 - 50 V).

Polarity: pos. or neg. selectable.

Transition times: ≤ 15 ns for leading and trailing edges.

Pulse top perturbations: $\leq \pm 5\%$ of amplitude.

General

Operating temperature: 0°C to 55°C.

Power: 100/120/220/240 Vrms; +5%, -10%, 48 to 66 Hz, 360 VA max.

Size: 133 mm H x 426 mm W x 422 mm D (5.2" x 16.8" x 16.6").

Weight: net 13.6 kg (30 lb). Shipping 15.6 kg (34.3 lb).

Ordering Information

214B Pulse Generator

Opt 001: Counted Burst

Opt 907: Front Handle Kit (part number 5061-0089).

Opt 908: Rack Mount Kit (part number 5061-0077).

Opt 909: Opt 907, 908 Combined (part number 5061-0083).

Opt 910: extra Operating and Service Manual

PULSE GENERATORS

Programmable Low Cost Pulse Generator

8112A

- Full pulse capability
- Modulation
- Ramps and haversines
- Width/duty cycle
- Device protection
- Error recognition and self test

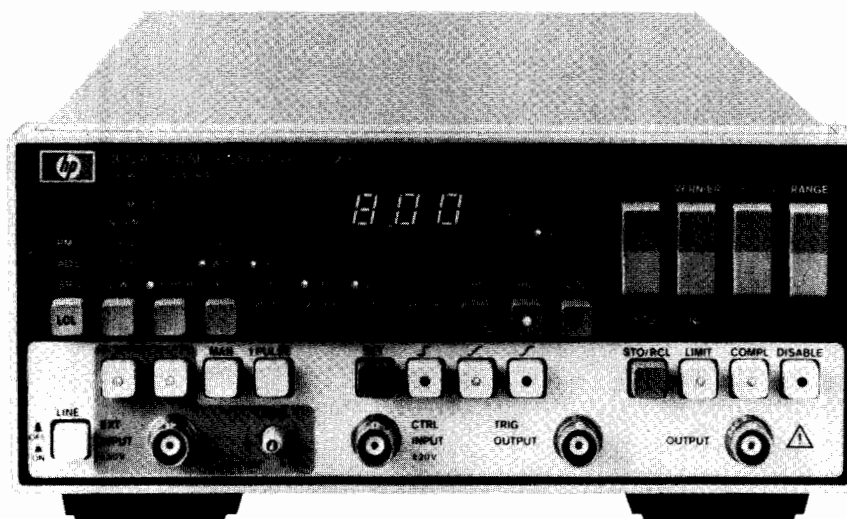

The 8112A is fully programmable 50 MHz pulse generator with 5 ns transitions and 32 Vpp (into open circuit) max output amplitude. All pulse parameters are variable including delay and double pulse spacing.

Besides the comprehensive trigger modes, external modulation capabilities extend applicability. 3-level signals and upper level, width, period and delay-modulated signals are available. These can be combined with the trigger modes so that complex real-life signals like modulated bursts are simulated easily.

Step response and trigger hysteresis measurements require fast transitions or sawtooth signals as obtained in the 8112A's linear transition mode—either fixed 5 ns or variable from 6.5 ns. The new cosine transitions, also variable from 6.5 ns, mean that band-filtered signals are now just as simple to obtain.

Sensitive devices are protected by programming output limits and the upper level can be controlled by the device supply. Also, constant energy or constant width can be programmed.

Dual channel operation is feasible by operating 8112A's in a master/slave combination.

For really easy operation a green button gives error-free settings. A new softkey operating concept plus detailed error recognition make the 8112A's powerful versatility easy to handle.

Specifications

Specifications apply with 50-ohm load, and temperatures in the range 0°C to 55°C.

Timing (specifications apply for min transition times)

Period: 20.0 ns to 950 ms.

Delay: 65.0 ns to 950 ms.

Double pulse: 20.0 ns to 950 ms.

Width: 10.0 ns to 950 ms.

Accuracy: $\pm 5\%$ of progr value ± 2 ns (delay: ± 4 ns).

Duty cycle: 1% to 99% (Min: 10 ns. Max: period -10 ns).

Accuracy: $\pm 10\%$ of progr value.

Pulse Characteristics (voltages double when driving into open circuit)

Levels

High level: -7.90 V to 8.00 V.

Low level: -8.00 V to 7.90 V.

Accuracy: $\pm 1\%$ of progr value $\pm 3\%$ amplitude ± 40 mV.

Settling time: 100 ns + transition time.

Transition times

Fixed: 5 ns

Linear and Cosine: 6.5 ns to 95.0 ms (max edge ratio 1:20 within a 1.5-decade range. Ranges overlap by 0.5 decade).

Accuracy: $\pm 5\%$ of programmed value ± 2 ns.

Preshoot, overshoot, ringing: $\pm 5\% \pm 10$ mV (variable transitions), $\pm 10\% \pm 10$ mV (fixed transitions).

Output resistance: 50 ohm $\pm 5\%$.

Operating modes: Normal, Trigger, Gate, Ext Width (pulse restoration), Ext Burst (1 to 1999 pulses).

Control (Modulation) Modes

Period, delay, width covered in 8 non-overlapping decades (max input frequency 20 kHz).

High level: -8 V to +8 V, independent of progr low level (min input transition 200 μ s).

General

HP-IB: all keys programmable. Learn, status and error reporting capability.

Memory: retains current operating state. 9 store/recall locations, 1 fixed set of parameters.

Repeatability: factor 4 better than accuracy.

Environmental

Storage temperature: -40°C to +65°C.

Operating temperature: 0°C to 55°C.

Humidity: 95% RH, 0°C to 40°C.

Power: 100/120/220/240 V rms; +5%; -10%; 48 to 440 Hz; 120 VA max

Weight: net, 5.9 kg (13 lb). Shipping, 8.0 kg (18 lb).

Size: 89 H x 212.3 W x 450 mm D (3.5" x 8.36" x 17.7").

Ordering Information

8112A Programmable Pulse Generator*

Opt 910: Extra Operating and Service Manual

5061-2001: Bail Handle Kit

5061-0072: Rack Mount Kit (single 8112A)

5061-0074: Rack Mount Kit (two instruments)

5061-0094: Lock Link Kit (for use with 5061-0074)

* HP-IB cables not supplied, see page 37

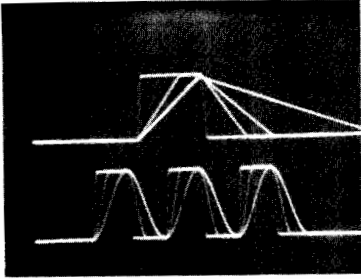

Linear Transitions

(upper trace) supply everything from fast pulses through trapezoids to ramps and triangles. These solve the stimulus requirements for such diverse applications as transient response evaluation, Schmitt trigger hysteresis measurements,

component stress characterization and materials testing. Variable transition times allow digital devices to be tested under the exact conditions specified by the IC manufacturer. Also, reflections caused by mismatch can be reduced by increasing the transition times.

Cosine-Shaped Transitions

Selectable cosine edges reduce signal bandwidth for transmission line testing. As shown in the lower trace in the above photograph, even haversines (which are ideal for simulating radar and similar signals) can be generated when the pulse width is set equal to transition time.

Counted Burst Mode

The external signal (upper trace) triggers a counted number of output pulses which can be used for clocking digital devices to an exact condition. The External signal can also be used to **trigger** single or double pulses, or to **gate** the output.

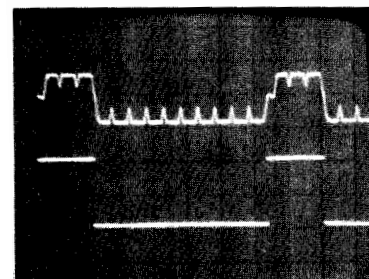
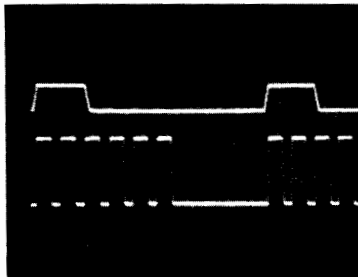

External Width Mode

The clean lower trace has been recovered from the noisy signal applied to the 8112A's External Input.

Flexible Transition Time Handling

allows excessive settings so that noise spikes (like those in the upper trace) as well as triangular waveforms can be generated.

Delay Control Mode

Phase Modulated signals can be simulated by controlling delay with an external voltage. The lower trace shows the effect on a double-pulse signal.

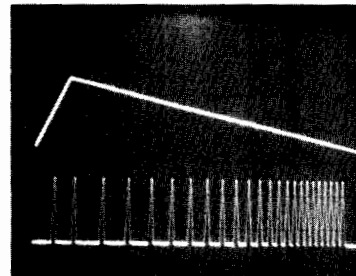
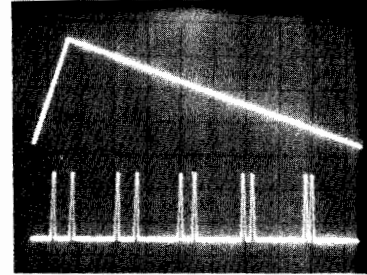

Period Control

PLL tracking accuracy and settling time can be evaluated with the period-modulated signals (lower trace) generated in the Period Control mode.

Width Control

As shown in the lower trace, PWM control signals can be simulated in this mode. As in the other timing control modes, the dynamic range is 1:10.

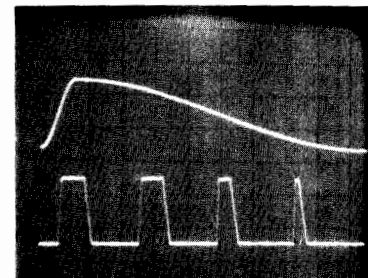

Dual-Edge Triggering

Both edges can be selected for triggering as well as just positive or negative. The lower trace shows how a magnetic storage device signal can be simulated by applying a signal (upper trace) simultaneously as external trigger and high-level control voltage.

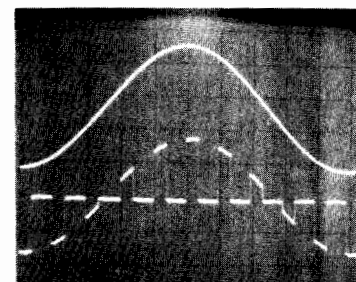
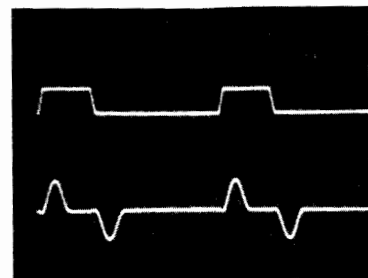

High-Level Control

In addition to producing 3-level signals like that in the previous photograph, high-level control mode can be used for simulating PAM signals and also for protecting CMOS.

PULSE GENERATORS

Programmable Precision Pulse Generators

Models 8160A, 8161A

- 50 MHz repetition rate
- 6.0 ns variable transition time
- 20 V output amplitude
- 1-3% pulse parameter accuracy
- Full dual channel capability (option 020)
- 1 year recalibration period

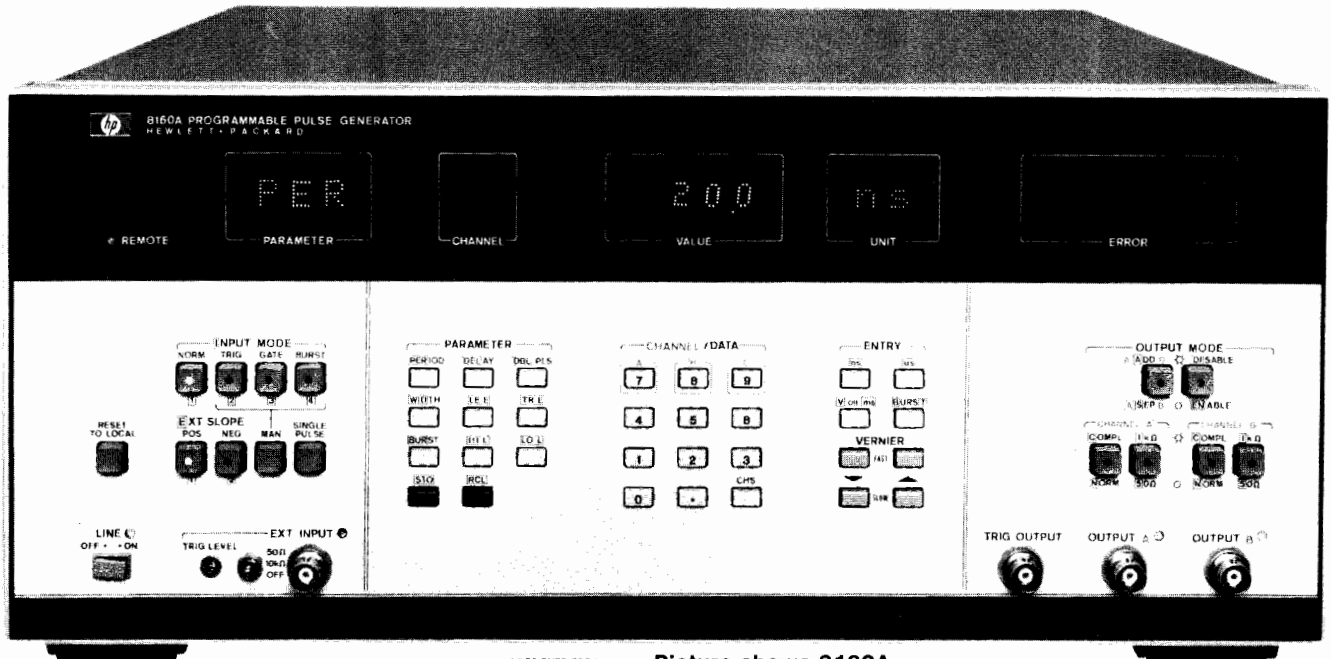

Picture shows 8160A with Option 020, Dual Channel

- 100 MHz repetition rate
- 1.3 ns variable transition time
- 5 V amplitude
- 1-3% basic timing accuracy
- Full dual channel capability (option 020)
- 1 year recalibration period

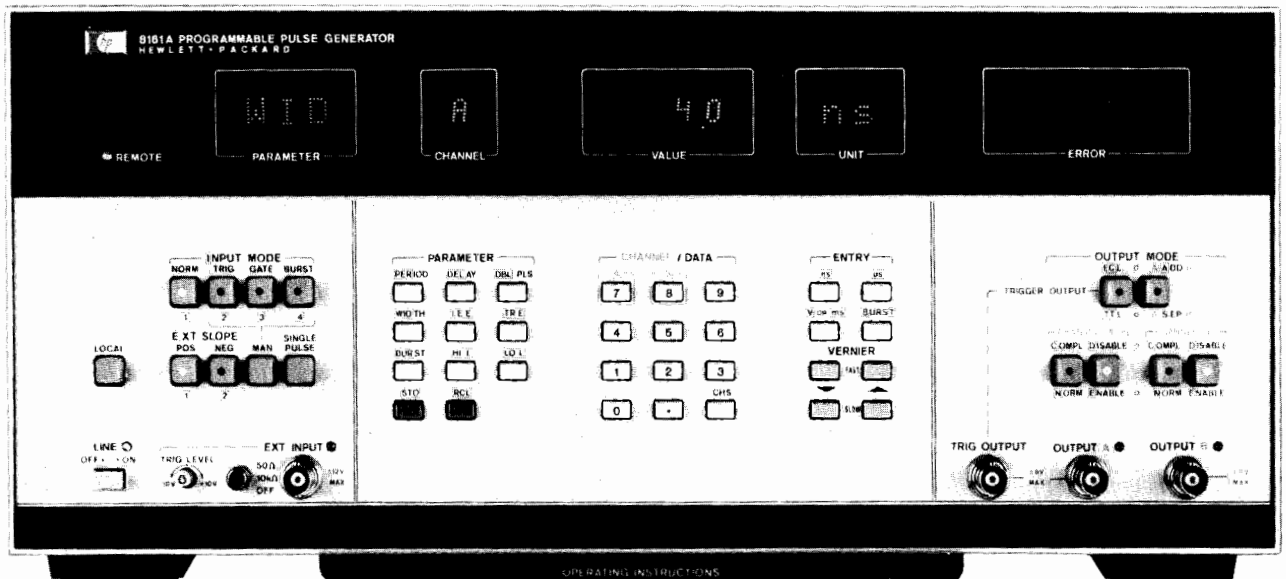

Picture shows 8161A with Option 020, Dual Channel

The 8160A and 8161A are fully programmable pulse generators designed for high performance applications on the bench and in automatic test systems. Operation is made easy because the pulse parameters are controlled independently and do not inter-react. Dual channel options permit synchronous or complex waveforms to be generated. With its 50 MHz repetition rate, 20 V output, and 6 ns variable transition times, the **8160A** is a general purpose pulse generator. The **8161A** covers the high end of technology with its 100 MHz, 5 V and 1.3 ns variable transition times. Measured between the 20% to 80% amplitude points, these transitions are faster than 1 ns and meet ECL requirements.

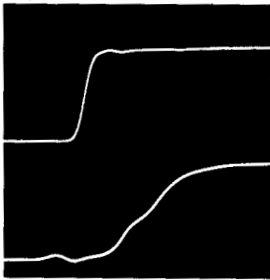

8161A input pulse (upper) and ECL memory output pulse (lower).

Combining high programming accuracy with microprocessor-based control capabilities, pulses can be set up without a measuring instrument. Pulse parameters are entered and displayed numerically, and generated with a basic timing accuracy of 1-3%, depending upon parameter.

An easy-to-use HP-IB interface brings high-accuracy pulses to automatic test. All parameters and operating modes are remotely programmable using straight-forward command sequences. Faster, easier program generation and reduced software costs are direct benefits.

Precision Pulse Generation

Both models provide precision control over all parameters of their output pulses. The 8160A's leading and trailing edge transition times may be independently programmed down to 6 ns. The 8161A's transitions have a common control from 1.3 ns to 5 ns, and are independent above 5 ns. Variable transition times are indispensable when digital IC's need to be characterized: either the IC's data sheeted input transition time is required, or the IC's functioning range with various transitions needs to be evaluated.

Direct entry of the high and low levels of the output pulse enables easy adjustment to the logic levels concerned. Pulse width is variable from 4 ns (8161A) or 10 ns (8160A) to 1 s, giving a wide range of duty cycle programmability. Delay shifts the output pulse in relation to the trigger output or, in double pulse mode, defines the pulse spacing.

In the dual-channel versions, double pulse can be selected in either or both channels. This means, for example, that simultaneous clock and data signals can be generated.

Complex Signals

Independent pulse parameters plus individual programmability of the Option 020's dual outputs are augmented by the A ADD B mode. Summation allows complex signals to be precisely and easily set up. Here are some examples:

Applications such as radar coincidence circuits and special codes in communications require 3- and 4-level signals. These are conveniently generated by combining channel A and channel B pulses.

A
SEP
B

A ADD B

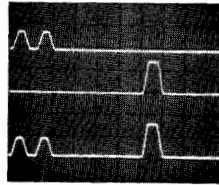
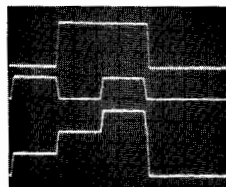

A
SEP
B

A ADD B

Transponder circuits need accurate delays, often with respect to a double-pulse interrogation signal. In the 8160A, this is arranged by operating one channel in double pulse mode and setting up the transponder delay in the other.

A critical test for digital circuits and IC's is its glitch and noise sensitivity, which can be easily performed with the A ADD B mode.

A
SEP
B

A ADD B

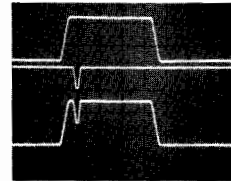

Counted Burst

Using Burst Mode, a predetermined number of pulses is generated independent of frequency. Bursts from 0 to 9999 pulses in length may be produced, and can be triggered via an external signal manually or with an HP-IB command.

Wide Temperature Range for System Reliability

The 8160A's and 8161A's 0-50°C operating range ensures calculable performance. Indeed, temperatures will generally be between 20-40°C where there is no derating factor.

User Features

Fast, Reliable Setup

Microprocessor control promotes highly accurate pulses. Parameters are directly entered via the instrument's keyboard, and are then displayed on numeric LED's with 3-digit resolution.

In bench applications, the vernier controls give a fine adjust capability to "tweak-in" any pulse parameter. You can increment or decrement the selected parameter either in single steps or at speed.

Error detection by the microprocessor further simplifies pulse setup by solving the old problem of incompatible settings. Should pulse width exceed pulse period, for example, the microprocessor indicates a TIMING error. All possible mis-settings are detected and the type of error is indicated to aid rapid correction.

HP-IB Programming

Microprocessor control over all interface functions makes remote programming as easy and straight-forward as manual control. The instruments employ keystroke programming so that data entry via the HP-IB is an exact simulation of manual entry. Bus commands for each front panel key simply replace manual keystrokes.

Parameter Storage

Complete parameter and mode information for 9 independent instrument set-ups can be stored. Waveforms may be stored and recalled either manually or via the HP-IB.

By utilizing a single command to recall an entire instrument set-up, controller time is saved. In simple repetitive testing applications, storage of test waveforms gives a high degree of user convenience without an external controller.

PULSE GENERATORS

Programmable Precision Pulse Generators

Models 8160A, 8161A (cont.)

Learn Mode

When interrogated by the system controller, the instruments output a character string to the interface bus. This string completely describes the pulser's current set-up or any one of its stored parameter sets. Using Learn Mode, you can enter and try out waveforms manually and then automatically transfer them via the HP-IB to the controller for storage in a program.

Verification Software for the 8160A

Test system accuracy is guaranteed by accessory software which verifies the 8160A's performance standards. The software is fully documented and comes recorded on a cassette suitable for Model 9825A Desktop Computer.

In the event of a failure, downtime is minimized because the software also delivers diagnostic information to accelerate repair and calibration.

Specifications

(50-ohm source into 50-ohm load). Standard instruments are single channel. Option 020 provides independent dual channels with common pulse period.

Timing (with minimum transitions)	8160A	8161A
Period Range: Accuracy: Max Jitter:	20 ns to 999 ms. ±3% of progr value ±0.3 ns (period < 100 ns); ±2% of progr value (period ≥ 100 ns). 0.1% of progr value + 50 ps.	10 ns to 980 ms. ±3% of progr value ±0.5 ns (period < 100 ns); ±2% of progr value (period ≥ 100 ns). 0.1% of progr value + 50 ps.
Delay, Double Pulse, Width Delay Range: Double Pulse Range: Width Range: Accuracy: Max Jitter:	0.0 ns to 999 ms. 20.0 ns to 999 ms. 10.0 ns to 999 ms. ±1% of progr value ±1 ns. 0.1% + 50 ps (≤999 ns); 0.05% (999 ns < -≤9.99 μs); 0.005% (>9.99 μs).	0.0 ns to 990 ms. 8.0 ns to 990 ms. 4.0 ns to 990 ms. ±1% of progr value ±1 ns. 0.1% + 50 ps (≤999 ns); 0.05% (999 ns < -≤9.99 μs); 0.005% (>9.99 μs).
Output Characteristics Output levels High Level Range: Low Level Range: Amplitude: Level Accuracy: Settling Time:	50 Ω into 50 Ω -9.89 V to 9.99 V. -9.99 V to 9.89 V. 0.10 V min, 9.99 V max. ±1% of progr value ±1% of ampl ±50 mV. 40 ns.	50 Ω into open or 1 kΩ into 50 Ω -19.7 V to 19.9 V -19.9 V to 19.7 V 0.2 V min, 19.9 V max
Transition Times (10 - 90% amplitude) Leading Edge: Trailing Edge: Accuracy: Linearity:	6.0 ns to 9.99 ms. 6.0 ns to 9.99 ms. ±3% of progr value ±1 ns. ±3% for transitions > 30 ns.	-4.95 V to 5.00 V. -5.00 V to 4.95 V. 0.06 V min, 5.00 V max. ±1% of progr value ±3% of ampl ±25 mV. 20 ns plus transition time.
Preshoot, Overshoot, Ringing:	±5% of ampl ±10 mV.	±5% of ampl ±10 mV (may increase to ±10% of ampl ±10 mV for transitions < 2.5 ns).
A ADD B:	Adds channel A and B outputs (Opt 020 only).	Adds channel A and B outputs (Opt 020 only).
Output Format:	Normal/Complement Selectable. (Independently selectable in each channel in Option 020.)	Simultaneous Normal and Complement Outputs. (Independently selectable in each channel in Option 020.)
Source Impedance:	50 ohm/1 kohm selectable.	50 ohm.

Operating modes: Normal, Trigger, Gate, Ext Burst (0-9999 pulses).

HP-IB capability: all modes and parameters can be programmed. Talk mode for status, error messages, stored parameters.

Memory: 9 programmable locations*,
1 location for active operating state*,
1 location with fixed parameter set.

Capacity: 1 complete operating state per location.

*Battery back-up for power-off storage

General

Recalibration period: 1 year.

Repeatability: factor 2 better than specified accuracy.

Operating temperature: 0°C to 50°C (Specifications apply from 20°C to 40°C. Accuracy derating factors for 0°C to 20°C and 40°C to 50°C).

Power: 115/230 V ac + 10%, -22%, 48-66 Hz; 675 VA max.

Weight: net 20.8 kg (46 lbs). Shipping 25 kg (55 lbs).

Size: 178 H x 426 x 530 mm D (7" x 16.8" x 20.9").

Ordering Information

8160A/8161A Programmable Pulse Generator*

Opt 001: Rear panel inputs and outputs

Opt 020: Second channel (Rate common)

Opt 907: Front handle kit (P/N 5061-0090)

Opt 908: Rack flange kit (P/N 5061-0078)

Opt 909: Opt 907, 908, combined (P/N 5061-0084)

Opt 910: Additional Operating Manual

08160-39910 Verification Software (8160A only).

* HP-IB cables not supplied, see page 37

PULSE GENERATORS

20 MHz Pulse Sources

Models 8005B, 8011A

315



- Dual outputs, +10 V and -10 V
- TTL output
- Gating, square wave, double pulse modes

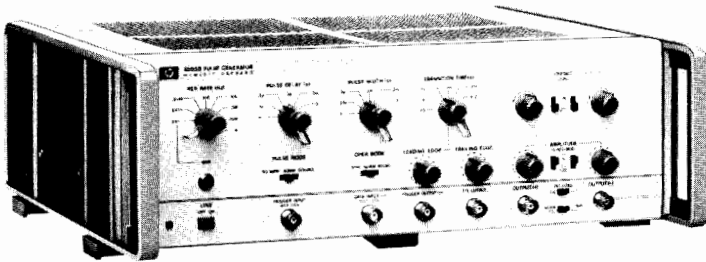

8005B

The 8005B is a general purpose, triple output pulse generator. This instrument has all parameters variable and produces simultaneous pos. and neg. pulses. It also has a TTL output with all parameters variable except amplitude. This feature, together with the normal/complement facility, greatly improves the ease of operation.

8005B Specifications

Pulse Characteristics

Transition times: ≤ 10 ns to 2 s. Edges independently variable.

Non-linearity: for transition times > 30 ns, $< 4\%$ of pulse amplitude.

Preshoot, overshoot, ringing: $< 5\%$ of pulse amplitude.

Pulse width: < 25 ns to 3 s. **Jitter:** $< 0.1\%$ of setting + 50 ps.

Max. duty cycle: $> 80\%$ (0.3 Hz - 1 MHz), $> 50\%$ (1-20 MHz).

Square wave: 0.15 Hz - 10 MHz.

Pulse delay: < 100 ns to 3 s. **Jitter:** $< 0.1\%$ of setting + 50 ps.

Pulse outputs: simultaneous pos., neg. and TTL outputs.

Pulse amplitude: 300 mV to 10 V.

Output protection: max. external voltage ± 10 V.

Source impedance: 50 ohms $\pm 10\%$ or high impedance selectable.

TTL compatible output: +4.6 V norm. or comp. 50 Ω impedance.

Repetition Rate and Trigger

Repetition rate: 0.3 Hz to 20 MHz in 5 ranges. **Jitter:** $< 0.1\%$ + 50 ps.

Double pulse: 10 MHz max. Simulates 20 MHz.

Trigger output: $> +2$ V ampl. across 50 ohms. **Width:** > 6 ns.

External Operating Modes

External Triggering (dc to 20 MHz)

Delay: approx. 35 ns trig. input to trig. output.

Maximum input: ± 10 V. **Sensitivity:** sine 2 Vpp.

Impedance: approx. 1k ohms, dc coupled. **Pulses:** ± 1 Vpeak.

Input pulse width: ≥ 10 ns.

Gating

Synchronous: gate signal turns on repetition rate. Last pulse is always completed.

Asynchronous: gate signal controls output of rate generator.

Gate Input (impedance 1 k ohms dc coupled)

Amplitude: 2 V to 20 V (max.). **Polarity:** negative.

General

Operating temperature: 0°C to 55°C.

Power: 115/230 V rms; +10%, -15%; 48 to 440 Hz, 180 VA max.

Weight: net 7 kg (15.5 lb). Shipping 9 kg (20 lb).

Size: 130 H x 426 W x 290 mm D (5.1" x 16.8" x 11.4").

Ordering Information 8005B, 8011A

8011A Pulse Generator

Opt 001: Pulse Burst

Opt 910: extra Operating and Service Manual

15179A (for 8011A): Adapter frame, Rack mount

for 1 or 2 units, includes blank panel for single-unit operation.

8005B Pulse Generator.

Opt 908: Rack Flange Kit (part number 5060-8740).

Opt 910: extra Operating and Service Manual.

- Repetition rate 0.1 Hz to 20 MHz
- Positive/negative/symmetrical output
- Normal/complement switch



Picture shows 8011A with Option 001, Burst.

The 8011A is a versatile, reliable, low cost pulse generator. This compact instrument features an uncomplicated design using high quality components to ensure long, dependable service. Ease of operation results from the logical and simple front panel layout. These qualities and the many pulse formats available emphasize the Model 8011A's cost-effectiveness in a wide application range.

8011A Specifications

Pulse Characteristics (50 ohm source/load impedances)

Transition times: < 10 ns fixed.

Overshoot, ringing and preshoot: $< \pm 5\%$ of pulse amplitude. May increase to 10% at counter-clock wise positions of amplitude vernier.

Pulse width: 25 ns to 100 ms in four ranges. Vernier provides continuous adjustment within each range.

Width jitter: $< 0.1\%$ + 50 ps on any width setting.

Maximum duty cycle: $> 50\%$ (100% using pulse complement)

Maximum output: 8 V. With internal 50 Ω and external Hi-Z or internal Hi-Z/external 50 Ω , then 16 V max.

Attenuator: 3-step attenuator provides the ranges 0.25 V - 1 V - 4 V - 16 V. Vernier provides continuous adjustment within each range.

Source impedance: 50 $\Omega \pm 10\%$ shunted by 30 pF, except in 4 V - 16 V range which is 50 Ω /Hi-Z, switch selectable.

Polarity/format: pos., neg., or sym./norm. or compl., switch select.

Repetition Rate and Trigger

0.1 Hz to 20 MHz in 5 ranges. Vernier provides continuous adjustment within each range. **Period jitter:** $< 0.1\%$ + 50 ps of per. setting.

Square Wave: 0.05 Hz to 10 MHz.

Trigger output: dc coupled 50 Ω (typ.) source delivering $\geq +1$ V into 50 Ω (can increase to +5 V). **Trigger pulse width:** 20 ns ± 10 ns.

External Operating Modes

Input impedance: 50 $\Omega \pm 10\%$. **Trigger polarity:** positive.

Maximum input: ± 5 V. **Sensitivity:** 1 V.

Manual: front panel pushbutton for generating single pulse.

Repetition rate: 0 to 20 MHz. In square wave, output frequency is half the input frequency.

Trigger source: manual or ext. signal. Min. ext. signal width 20 ns.

Pulse burst mode (option 001): preselected number of pulses generated on receipt of trigger.

Burst trigger source: man. or ext. signal. Min. signal width 25 ns.

General

Operating temperature: 0°C to 55°C.

Power: 100/120/220/240 V rms; +5%, -10%; 48 Hz to 440 Hz, 70 VA max.

Weight: net, 4 kg (9 lb). Shipping, 6.5 kg (14.6 lb).

Dimensions: 126 H x 200 W x 280 mm D (5" x 7.9" x 11").

PULSE GENERATORS

50 MHz Pulse Sources

Models 8012B & 8013B

- Variable transition times down to 5 ns
- ± 10 V amplitude; selectable source impedance
- Ideal for testing TTL

- Fixed 3.5 ns transition times
- 10 V amplitude; selectable source impedance
- 2 outputs

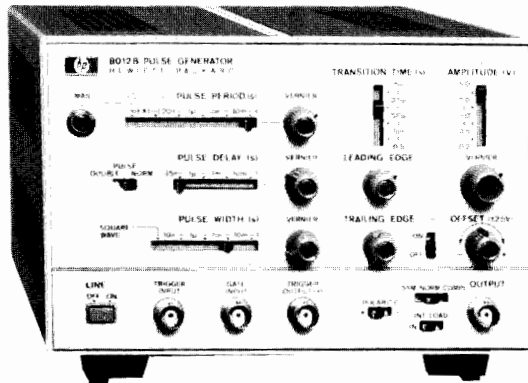

8012B

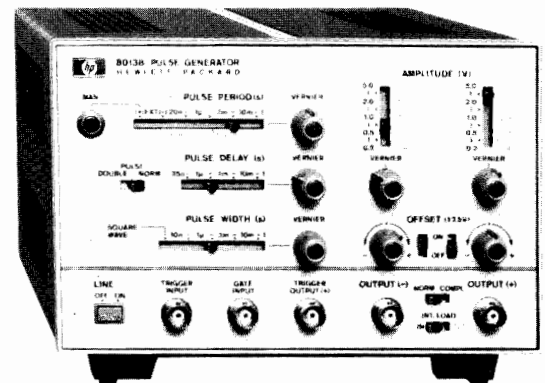

8013B

The 8012B and 8013B are at the top of their class for versatility, ease of operation and wide range of application. They provide the ideal solution to almost all digital logic testing problems with fixed 3.5 ns transition times on the 8013B and variable transition times down to 5 ns on the 8012B. The well-composed layout of the front panel controls (horizontal controls for horizontal parameters, vertical controls for vertical parameters) enables output pulses to be set up quickly and accurately with minimum risk of incompatible settings. Both models feature normal and complement outputs and a switchable internal 50 ohm source.

Pulse delay: <35 ns to 1 s (with respect to trigger output) in four ranges; vernier provides continuous adjustment within ranges.
Delay jitter: <0.1% + 50 ps on any setting.

Repetition Rate and Trigger

1 Hz to 50 MHz in four ranges, continuous adjustment within ranges.
Period jitter: <0.1% + 50 ps on any rate setting.
Square wave: 0.5 Hz to 25 MHz in four ranges. Duty cycle 50% $\pm 5\%$ up to 1 MHz, tolerance increases to $\pm 15\%$ at 25 MHz.
Trigger output: > +1 V across 50 Ω , 16 ns ± 10 ns wide.

Specifications

Pulse Characteristics

Parameter	8012B		8013B	
	Int. load IN	Int. load OUT	Int. load IN	Int. load OUT
Transition times	5 ns—0.5s 4 ranges, Verniers provide separate control of both edges within ranges up to max. ratios of 100:1 or 1:100.	6 ns—0.5s	3.5 ns fixed	5 ns fixed
Source impedance	50 ohms $\pm 10\%$ shunted by typically 20 pF	>50 ohms	50 ohms $\pm 3\%$ shunted by typically 20 pF	>50 ohms

Parameter	8012B/8013B	
	Internal load IN	Internal load OUT
Overshoot ringing	$\pm 5\%$ of pulse amplitude	May increase to $\pm 10\%$ when amplitude is between 0.4—4 V
Maximum output	5 V across 50 ohms, 10 V across open circuit. Short cct. protection.	10 V across 50 ohms, Short cct. protection.
Attenuator	4-step, reduces output to 0.2 V.	4-step, reduces output to 0.4 V.
DC offset	± 2.5 V across 50 ohms. Independent of amplitude settings.	DC offset switched off.

Linearity (8012B): for transition times >30 ns, maximum straight line deviation is 5% of pulse amplitude.

Preshoot: < $\pm 5\%$ of pulse amplitude.

Pulse width: < 10 ns to 1 s in four ranges. Vernier provides continuous adjustment within ranges.

Width jitter: <0.1% + 50 ps on any width setting.

Maximum duty cycle: >75% from 1 Hz to 10 MHz, decreasing to $\geq 40\%$ at 50 MHz. Up to 100% in COMPL mode.

Polarity: 8012B; positive or negative selectable, NORM/COMPL/SYM selectable; 8013B, one positive + one negative channel, NORM/COMPL selectable.

External Triggering

0 to 50 MHz; for square wave output, frequency divided by factor 2.
Trigger input: sine waves 1.5 V p-p (about zero) or pulses >0.8 V either polarity, >7 ns wide. Maximum input ± 7 V.
Impedance: 50 Ω $\pm 10\%$, dc coupled.
Delay: 25 ns ± 8 ns leading edge trig. input to trig. output.
Manual: pushbutton for single pulse.

Gating

Synchronous gating: gating signal turns generator "on". Last pulse is completed even if the gate ends during pulse.
Gate input: dc-coupled; voltage at open connector approx. +1.8 V. Shorting current ≤ 12 mA. Input impedance ≈ 160 Ω
Gate input signal: voltage >+1.5 V or resistor > 1 k Ω to ground enables rep. rate generator. Voltage <+0.8 V or resistor <160 Ω disables rep. rate generator. Input TTL compatible, max. ± 5 V.

External Width and RZ

External width: output pulse width determined by width of drive input signal. Amplitude, transition times selectable. Trigger output independent of external width input signal.

RZ mode: external drive input switched to delay generator. Period determined by period of drive input signal. Delay, amplitude and width selectable.

Input signal: >+1 V, >7 ns wide. Max. ± 5 V. 50 Ω dc coupled.

General

Operating temperature: 0°C to 55°C.

Power: 100/120/220/240 V rms; +5%, -10%; 48 to 400 Hz, 100 VA max.

Weight: net, 4kg (8.8 lb). Shipping, 6.5 kg (14.6 lb).

Size: 126 H x 200 W x 280 mm D (5 x 7.9 x 11 in.)

Ordering Information

8012B Pulse Generator

Opt 910: extra operating and service manual

8013B Pulse Generator

Opt 910: extra operating and service manual

15179A Adapter frame. Rack mounting for 1 or 2 units, includes blank panel for single-unit requirements

PULSE GENERATORS

50 MHz, Dual Output

Model 8015A

317



- Two independent ± 16 V outputs
- Additional TTL output

- Remote control and counted burst options
- Complex waveforms

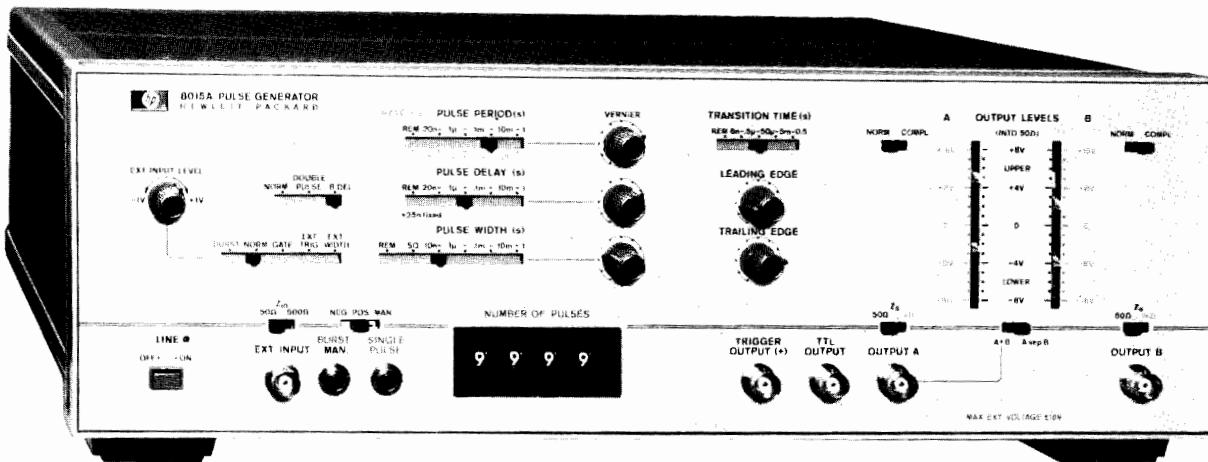

Picture shows 8015A with Option 002, Burst

Offering B Delay mode in addition to variability of all pulse parameters, the 8015A is ideal for analyzing critical timing conditions, or generating 2-phase clocks.

A + B mode gives a 30 V output within a ± 16 V window. Combined with B Delay mode, three-level signals, special codes or simulated biomedical signals can be generated.

Option 002 Burst mode generates an exact number of pulses by means of an internal counter.

Direct access to either or both output amplifiers (Option 007) converts to MOS/CMOS levels. Alternatively, high-level tracking capability ensures that clock and data signals follow the supply, and thus safeguards CMOS devices.

For use in automatic test, Option 003 allows all pulse parameters to be controlled remotely.

Specifications

Timing

Repetition rate: 1 Hz to 50 MHz (square wave and double pulse to 25 MHz, A + B mode to 40 MHz, B delay 20 MHz).

Width: 10 ns to 1 s or square wave.

Delay: 20 ns to 1 s (both channels, interchannel or double pulse).

Jitter: 0.1% + 50 ps.

Output (50 Ω Output Impedance into 50 Ω termination. Voltages double in 50 Ω / 1 k Ω or 1 k Ω / 50 Ω operation).

Magnitude: 1 V to 8 V amplitude (2 V to 16 V in A + B mode).

High level: -7 V to +8 V. **Low level:** -8 V to +7 V.

Transition times: 6 ns to 0.5 s in four ranges, independent leading/trailing vernier adjustment.

Non-linearity: 5% for transitions > 30 ns.

Preshoot, overshoot and ringing: 5%.

A + B mode: sum of channel A and channel B outputs.

Complement: independently selectable.

Impedance: 50 Ω / 1 k Ω , independently selectable.

Trigger Input

Impedance: 50 Ω / 500 Ω selectable.

Level: adjustable +1 V to -1 V (50 Ω), +10 V to -10 V (500 Ω).

Slope: + or - selectable.

Auxiliary Outputs

TTL: 50 Ω output impedance, timing as channel A.

Trigger output: 1 V, 50 Ω into 50 Ω .

Option 002 Burst Mode

Burst length: 1-9999 pulses, selectable.

Pulse repetition rate: 1 Hz to 40 MHz.

Burst trigger: trigger input.

Minimum burst separation: 200 ns.

Option 003 Remote Control

Timing ranges: TTL or contact closure.

Timing verniers: current, voltage or resistor programming.

Output levels: voltage programming.

Burst: BCD, TTL/contact closure.

Option 007 Amplifier and Tracking Modes Dual Amplifier Mode

Gain: 0.8 to 6.4.

Frequency response (-3 dB): 0 to 80 MHz.

Upper Level Tracking Mode

Upper level: input voltage $\pm 5\%$.

Lower level: 0 V ± 250 mV.

Settling time: 400 μ s to $\pm 5\%$ of final value.

General

Operating temperature: 0°C to 55°C.

Power: 100/120/220/240 V rms; +5%, -10%; 48 to 440 Hz, 180 VA max.

Weight: net, 11 kg (24.26 lb). Shipping, 14.7 kg (32.4 lb).

Size: 133 H x 426 W x 346 mm D (5.2" x 16.75" x 13.6").

Ordering Information

8015A Pulse Generator

Opt 002: Pulse Burst

Opt 003: Remote Control

Opt 007: Dual Amplifier and Level Tracking modes

Opt 907: Front Handle Kit (Part No. 5061-0089)

Opt 908: Rack Flange Kit (Part No. 5061-0077)

Opt 909: Opt. 907, 908 combined

(Part No. 5061-0083)

Opt 910: Additional Operating and Service Manual



PULSE GENERATORS

100 MHz Pulse Source

Model 8007B

- Variable transition times down to 2 ns.

- Extremely linear slopes

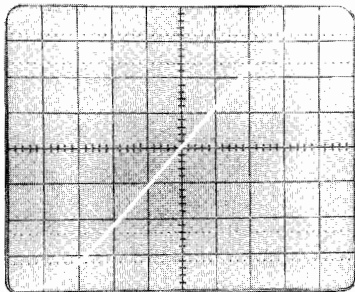
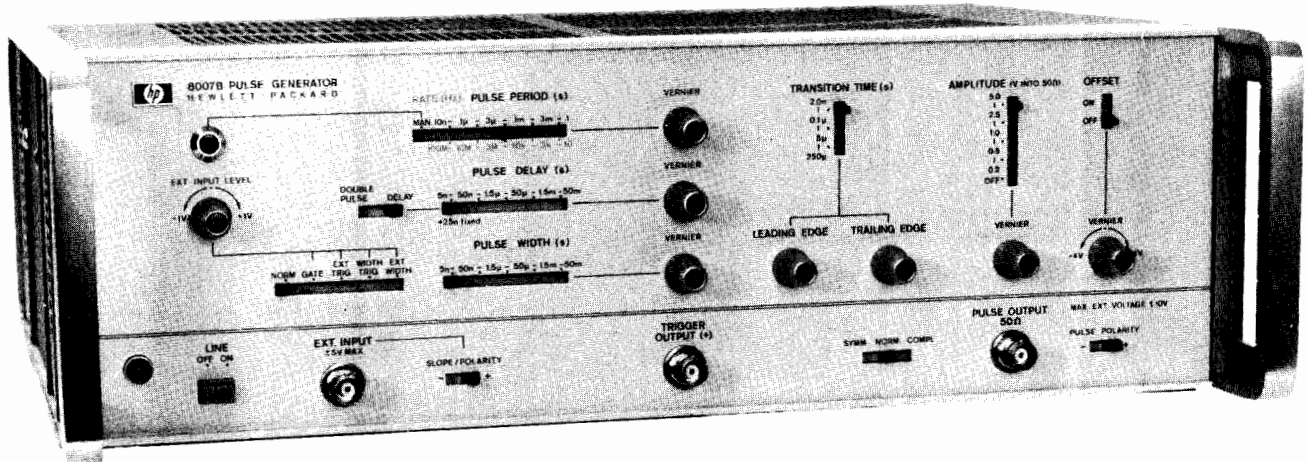

1 ns/cm
0.5 V/cm
1 GHz bandwidth

The 8007B is a high speed pulse generator that is well suited for STTL and ECL applications.

The output can be set to positive or negative polarity, complement or symmetrical to ground. A high dc-offset of up to ± 4 V is also included.

External triggering and synchronous gating are provided. The trigger level is adjustable for all externally controlled modes with the slope polarity selectable. This is very useful for avoiding malfunctions caused by noise and ringing on the external trigger signal.

In "External Width" mode the external input and pulse output have equal width. Transition times and amplitude of the output pulse can be set by the front panel controls. This mode is useful for shaping NRZ signals, as the width information is passed on to the output pulse unchanged.

The "Width Trigger" mode is suitable for RZ signal shaping. Width, transition times and amplitude are determined by the front panel controls.

Specifications

Pulse Characteristics (50 Ω source and load impedance)

Transition times: < 2 ns to 250μ s, three ranges (common for both transition times). Independent verniers for adjusting leading and trailing edge within each range up to maximum ratios of 1:50 or 50:1.
Linearity: maximum deviation from a straight line between 10% and 90% points $\leq 5\%$ of pulse amplitude.

Preshoot, overshoot, ringing: $< \pm 5\%$ of pulse amplitude.

Pulse width: < 5 ns to 50 ms in five ranges. Vernier provides continuous adjustment within ranges.

Width jitter: $< 0.1\%$ on any width setting.

Maximum duty cycle: normal $> 50\%$; complement approx. 100%.

Amplitude: 5 V max (10 V across open circuit) to 0.2 V in four ranges; vernier adjustment within ranges. Pulse can be switched off.

Pulse output: + or - polarity selectable; normal, complement, or symmetrical to ground.

Source impedance: $50 \Omega \pm 4 \Omega$ shunted by typ. 10 pF.

DC-offset: ± 4 V across 50Ω load. Independent of amplitude setting, can be switched off.

Pulse delay: < 30 ns to 50 ms with respect to trigger output. Five ranges, with continuous adjustment within ranges.

Delay jitter: $< 0.1\%$ on any delay setting.

Repetition Rate and Trigger

10 Hz to 100 MHz in 5 ranges. Continuous adjustment within ranges.

Period jitter: $< 0.1\%$.

Double pulse: available only up to pulse rate setting of 50 MHz, representing an output pulse rate of 100 MHz.

Trigger output: $> +1$ V across 50Ω , 4 ns ± 2 ns wide.

External Triggering (0 to 100 MHz)

Delay: approx. 15 ns between trig. input and trig. output.

Manual: front panel pushbutton for single pulse.

External Width and Width Trigger

External width: output pulse width determined by width of drive input.

Width trigger: external drive input switched to the width generator. Pulse width determined by front panel width setting.

Rate generator: provides trigger pulses independent of drive input.

Synchronous Gating

Gating signal turns generator "on." Last pulse is completed even if gate ends during pulse.

External Input

Impedance: 50Ω , dc-coupled. Max input ± 5 V.

Level: adjustable from +1 V to -1 V, Polarity: + or -.

Sensitivity: sine waves 1 V p-p; pulses 1 V.

General

Operating temperature: 0°C to $+55^\circ\text{C}$.

Power requirements: 115 or 230 V rms; $+10\%$, -15% ; 48 to 440 Hz, 100 VA (maximum).

Weight: net, 8 kg (17.6 lb). Shipping, 9 kg (19.8 lb).

Size: 128 H x 426 W x 345 mm D (5" x 16.8" x 13.6").

Ordering Information

Opt 908: Rack Flange Kit (Part No. 5060-8740)

Opt 910: Additional Operating and Service Manual

PULSE GENERATORS

250 MHz Fast Pulse Source

Model 8082A

319



- <1 ns variable transition times
- Ultra-clean 50 ohm source

- Switch-selectable ECL levels
- Dual ± 5 V outputs

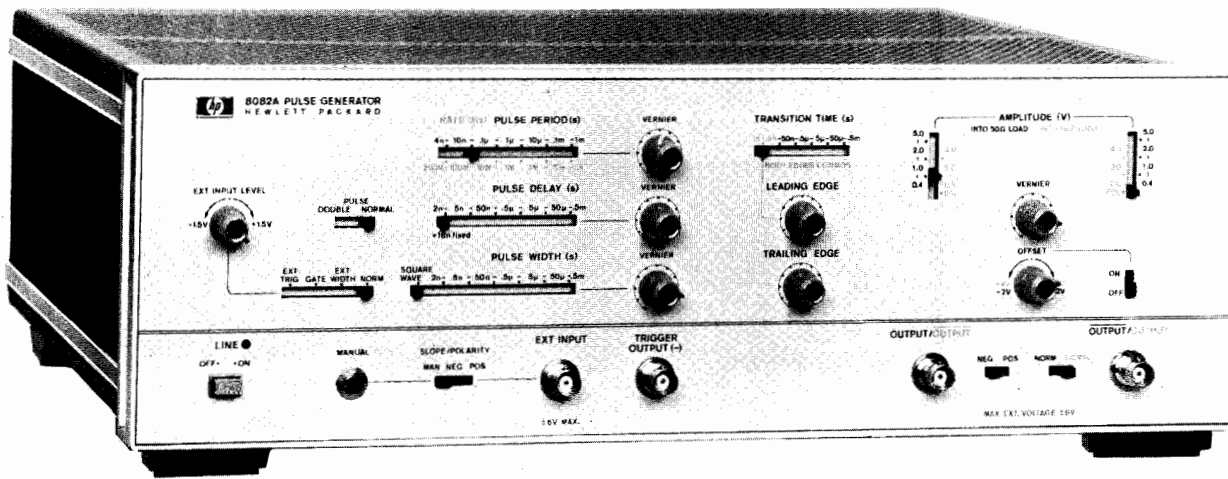

The 8082A is Hewlett-Packard's fastest pulse generator with all pulse parameters variable. With repetition rates to 250 MHz, transition times down to 1 ns and amplitudes to 5 V, the 8082A is ideally suited for state-of-the-art TTL and ECL logic designs. Using the 8082A, you can rapidly test logic circuits under all operating conditions by simply varying pulse parameters. Although a highly sophisticated instrument, the 8082A is still easy to operate because of its logical front panel layout and switch selectable ECL output levels. Another feature that contributes to ease of operation is the square wave mode. You can, for example, carry out toggle rate tests in this mode up to 250 MHz without having to worry about pulse duty cycle.

Hybrid IC's, manufactured by Hewlett-Packard, are used extensively in the design of the 8082A. These ICs eliminate the need for fans, reduce power consumption and enable a low reactance 50 ohm source impedance to be used. This source impedance absorbs 98% of reflections from signals up to 4 V amplitude.

Specifications

Pulse Characteristics (50 Ω source and load impedance)

Transition times: <1 ns - 0.5 ms (10% to 90%) in 6 ranges. <750 ps (20% to 80%). Leading/trailing edges controlled together on fastest range, independently variable over 1:10 ratio on other ranges.

Overshoot and ringing: $\leq \pm 5\%$ of pulse amplitude may increase to $\pm 10\%$ with amplitude vernier CCW.

Preshoot: $\leq \pm 5\%$ of pulse amplitude.

Linearity: linearity aberration for both slopes $\leq 5\%$ for transition times >5 ns.

Output: maximum amplitude is 5 V from 50 Ω into 50 Ω . Maximum output voltage is ± 5 V (amplitude + offset).

Offset: ± 2 V, into 50 Ω .

DC-source impedance: 50 $\Omega \pm 5\%$.

Reflection coefficient: reflection is 2% typical for steps with 1 ns rise time applied to output connector on all amplitude ranges except 5 V range. On the 5 V range, the reflection may be 15%.

Output protection: cannot be damaged by open or short circuits or application of ext. $\leq \pm 6$ V or ± 200 mA independent of control settings.

Attenuator: two separate three step-attenuators reduce the outputs to 1 V. Vernier is common for both outputs and reduces the output to 0.4 V minimum. A further position provides ECL-compatible outputs (-0.9 V to -1.7 V typ. open circuit).

Timing

Repetition rate: 250 MHz to 1 kHz in 6 ranges.

Period jitter: <0.1% of setting +50 ps.

Delay: 2 ns - 0.5 ms in 6 ranges plus typ. 17 ns fxd. with respect to trigger output. Duty cycle >50%.

Delay jitter: <0.1% of setting +50 ps.

Double pulse: up to 125 MHz max. (simulates 250 MHz).

Pulse width: <2 ns - 0.5 ms in 6 ranges.

Width jitter: <0.1% of setting +50 ps.

Width duty cycle: >50%.

Square wave: delay and double pulse are disabled, max. Rep. Rate 250 MHz. Duty cycle is 50% $\pm 10\%$ up to 100 MHz, 50% $\pm 15\%$ for >100 MHz.

Trigger output: negative going Square Wave (50% duty cycle typ.) >500 mV from 50 Ω into 50 Ω . Internal 50 Ω can be switched off by slide-switch on PC-board. Amplitude up to 1 V into 50 Ω up to 200 MHz.

Trigger output protection: cannot be damaged by short circuit or application of external ± 200 mA.

External Operating Modes

External Input

Input impedance: 50 $\Omega \pm 10\%$. dc coupled.

Maximum input: ± 6 V.

Trigger level: adjustable -1.5 V to +1.5 V.

Slope control: positive, negative or manual selectable. In the manual position all ext. functions can be controlled by push button. Button pushed in simulates an "on-signal."

Sensitivity: sine-wave >200 mV p-p pulses >200 mV.

Repetition rate: 0 to 250 MHz.

External-Controlled Modes

External trigger: there is approximately 7 ns delay between the external input and the trigger output. Rep. rate is externally controlled (is triggered by external signal). Trigger output provides the pulse-shaped input signal.

Synchronous gating: gating signal turns rep. rate generator on. Last pulse normal width even if gate ends during pulse.

External width: output pulse width determined by width of drive input. Rep. rate and delay are disabled. Trigger output provides shaped input signal.

General

Operating temperature: 0°C to 55°C.

Power: 100/120/220/240 Vrms; +5%, -10%; 48-440 Hz. 85 VA max.

Weight: net, 7.9 kg (17.44 lb). Shipping 8.9 kg (19.63 lb).

Size: 133 mm H x 426 W x 345 mm D (5.2" x 16.75" x 13.6").

Ordering Information

8082A Pulse Generator

Opt 907: Front Handle Kit (part number 5061-0089).

Opt 908: Rack Flange Kit (part number 5061-0077).

Opt 909: Opt 907, 908 Combined (part number 5061-0083).

Opt 910: Additional Operating and Service Manual



PULSE GENERATORS

Configurable Pulse/Data Stimuli 8080A Series

Example: 8080A, SO4

- 1 GHz, 300 ps transitions
- Interchannel delay

Example: 8080A DO1

- 300 MHz, 800 ps transitions
- Manually programmable data

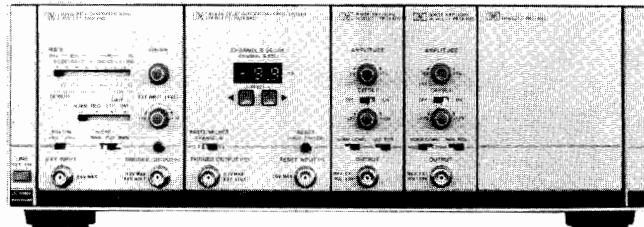

8091A Rate Generator 8092A Delay Generator CHA CHB 8093A Output Amplifiers

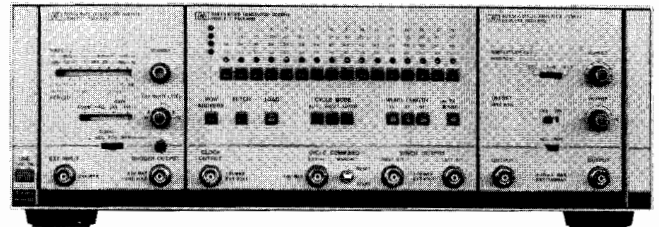

8081A Rate Generator 8084A Word Generator 8083A Output Amplifier

Research and development in advanced technologies such as subnanosecond ICs, fiber optics and nucleonics, require fast pulses for thorough characterization. The 8080A can, for example, generate simultaneous 1 GHz clock and simulated NRZ data for testing today's fastest memories, or complementary data with up to 64 bits and fast 300 ps edges for state-of-the-art communication devices. Cost-effectiveness is promoted because the 8080A's modular structure allows performance and capability to be tailored to the requirement.

Two examples are shown here. Full details of these and all other factory-systemized configurations are in the data sheet. Individual modules are also available for special applications or for extending an existing configuration. Ask for the systemizing and adjustment guidelines.

Leading Characteristics (50-ohm load)

8080A SO4

Timing

Repetition rate: 100 Hz – 1 GHz.

Interchannel delay: ± 9.9 ns in 0.1 ns steps.

Channel B divider: 0.5 f selectable for simulating NRZ data.

Width: Square wave.

Modes: Int, Ext Width, Gate, Manual.

Independent 50-ohm Outputs

Amplitude: 0.6 V to 1.2 V_{pp}.

Offset: ± 1.2 V.

Transitions times (10% to 90%): <300 ps.

Polarity: selectable

Format: Normal/Complement selectable

8080A DO1

Timing

Repetition rate: 10 Hz–300 MHz.

Width: square wave (RZ) or NRZ.

Modes: Int, Ext/Manual Width.

Data cycle modes: Ext/Man Single and Gated Cycle, Auto Cycle.

Data: Serial, 16/32/64 bit selectable.

Simultaneous Normal and Complement 50-ohm Outputs

Amplitude: 0.2 V to 2 V.

Offset: ± 1 V.

Transition times (10% to 90%): <800 ps.

Polarity: selectable.

General

Operating temperatures: 0°C to 55°C.

Power: 115/230 V rms; + 10%, -22%; 48 to 66 Hz, 200 VA max.

Weight: (typical, 8080A Mainframe plus full complement of modules) 9.4 kg (16.6 lbs) net; 19.7 kg (43.3 lbs) shipping.

Size: (8080A Mainframe): 133 H x 426 W x 422 mm D (5.24" x 16.77" x 16.61").

Ordering Information

8080A Mainframe

Opt 907: Front handle kit

Opt 908: Rack flange kit

Opt 909: Opt 907, 908 combined

Opt S01: (8081/83A, 2 × 15400A)

Opt S02: (8081/93A, 2 × 15400A, 15401A)

Opt S03: (8091/93A, 2 × 15400A, 15401A)

Opt S04: (8091/92A, 2 × 8093A, 15400A)

Opt DO1: (8081/83/84A)

Opt DO2: (8081/84/93A, 15401A)

Opt DO3: (8081/84A, 2 × 8093A)

8081A 300 MHz Rate Generator module

8083A 300 MHz Output Amplified module

8084A 300 MHz Word Generator module

8091A 1 GHz Rate Generator module

8092A 1 GHz Delay Generator module

8093A 1 GHz Output Amplifier module

Opt HO1: For variable-width operation with 8092A

Additional manuals: Opt 910, per module

Accessories Available

15400A Blank Panel, ¼ mainframe width

15401A Blank Panel, ½ mainframe width

15402A BNC Feedthru panel, ¼ width

Pulse Generator Accessories



15104A / 15115A

15104A Pulse Adder/Splitter dc to 2 GHz

15116A Pulse Inverter 3 MHz to 2 GHz

15115A Pulse Splitter/Inverter 3 MHz to 2 GHz



15116A



PULSE GENERATORS

High Resolution Time Synthesizer

Model 5359A

321



- Precise digital delays 0-160 ms
- 50 ps increments
- Jitter < 100 ps

- Programmable
- Fully synchronous to external trigger
- Automatic calibration

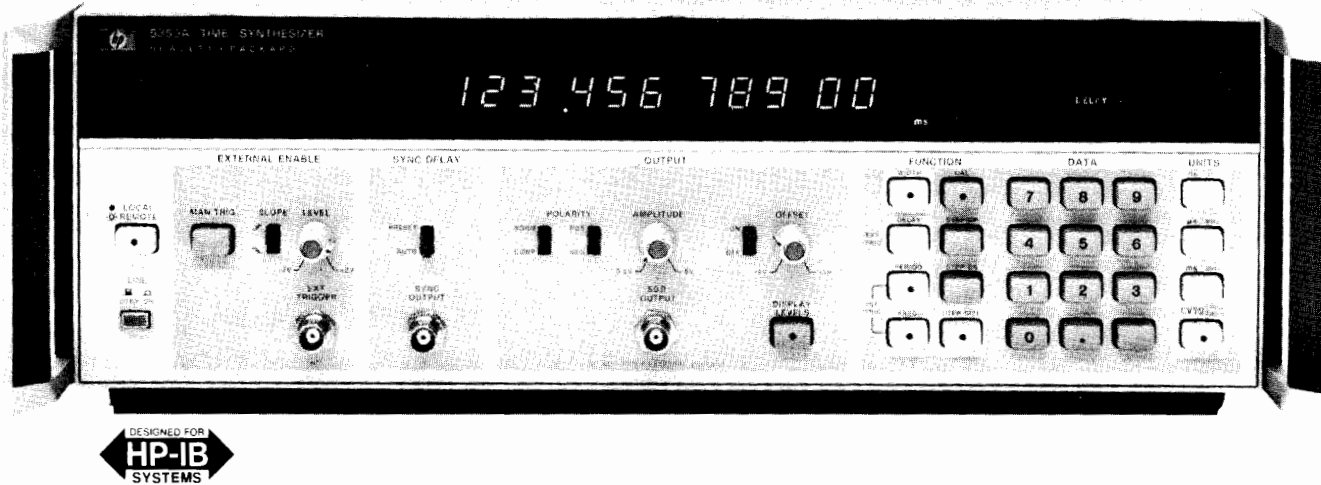

The 5359A Time Synthesizer produces two extremely precise, low jitter time delays. These delays, T_d and T_w , are individually selectable by means of the keyboard, in 50 ps or greater steps to generate delays of up to 160 ms.

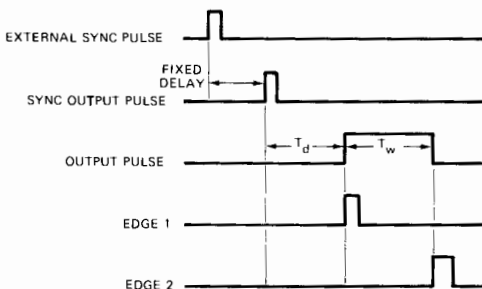

The 5359A has many applications and may be used for the calibration of Radar, Loran, DME and Tacan Systems, or for precision generation of delayed sweeps in oscilloscopes, and for extremely accurate "time positioning" control of external gates on frequency counters. In component and circuit test, the instrument may be used for extremely accurate delay line simulation.

Specifications

Modes

External trigger mode: the delays from the sync out to the beginning of the output pulse, and the width of the output pulse, are selected.

Internal trigger mode: the "period" or "frequency", and the width of the output pulse, are selected.

Range

Delay T_d : 0 ns to 160 ms.

Width T_w : 5 ns to 160 ms (width & delay \leq 160 ms).

Period: 100 ns min. or width + 80 ns, 160 ms max.

Frequency: same as corresponding "period".

Repetition rate: 10 MHz max.

Accuracy: ± 1 ns \pm time base error.

Insertion delay: fixed at < 150 ns; selectable as < 50 ns for delays > 100 ns.

Jitter: typical 100 ps rms; maximum 200 ps rms

External trigger input: -2 V to + 2 V slope selectable.

Sync output: 1 V - 50 Ω ; 5 V - 1 M Ω . Width 35 ns nominal.

Output Pulse

Amplitude: 0.5 V to 5 V into 50 Ω .

Polarity: positive or negative.

Offset: -1 V to 1 V, or OFF.

Transition time: < 5 ns.

External voltage must not be applied. Offset and Amplitude voltage into 50 Ω may be displayed.

EDGE 1 OUTPUT (rear panel): occurs in Sync with leading edge of output pulse (same spec. as Sync out).

EDGE 2 OUTPUT (rear panel): occurs in Sync with falling edge of output pulse (same spec. as Sync out).

Events mode: substitutes external input (to 100 MHz) for the internally counted clock (delay and width must both be specified in terms of events instead of time).

Triggered frequency mode: the same as internal frequency mode except the output is a burst beginning in synchronism with an external trigger signal, and continues for the duration of this signal.

Calibrate mode: performs an internal calibration to remove the effects of internal delay differences.

External probes: provides outputs to control the 5363B probes and accepts inputs from the probes to include external devices in the calibration loop.

HP-IB: All controls except trigger levels are programmable as standard.

Time Base

High Stability Oven Oscillator

Frequency: 10 MHz

Aging: $< 5 \times 10^{-10}$ /day

Temperature: $< 2.5 \times 10^{-9}$, 0°C to 50°C

Line voltage: $< 1 \times 10^{-10}$, $\pm 10\%$ from nominal

Size: 146.1 H x 425.5 W x 520.7 mm D (5.25" x 16.75" x 20.50").

Weight: 30 lbs.

Power requirements: 100, 120, 220, or 240 Vac +5% -10%, 48 to 66 Hz, less than 250 VA

Front handles: supplied with instrument.

Options and Accessories

908: Rack Flange Kit for use without handles

913: Rack Flange Kit for use with supplied handles

10870A: Service Kit

5359A Time Synthesizer

FUNCTION GENERATORS & FREQUENCY SYNTHESIZERS

General Information



Function Generators

The function generator is a versatile, multi-waveform signal source capable of very wide frequency coverage.

The HP 3310A/B, 3311A, 3312A, 3314A, and 3325A offer a complete set of functions including sine, square, triangle, ramp, and even Arbitrary Waveforms (3314A). For ex-

tended pulse capabilities, the 8111A and 8116A Pulse/Function Generators include precise timing waveforms.

In addition to this complete set of waveforms, Function Generators include versatile modulation capabilities such as amplitude, frequency, phase, pulse width, and VCO control.

The Function Generator is an indispensable general purpose signal source for production testing, instrument repair, and the electronics laboratory. Diverse fields of applications in which the function generator is being used include medical research, education, chemical, communications, geophysics, industrial control, military and aerospace.

Function Generator Summary

	Function Generators				Pulse/Function Generators		Synthesizer/Function Generators	
	3310A/B	3311A	3312A	3314A	8111A	8116A	3325A	8165A
Frequency								
Min	0.5 MHz	0.1 Hz	0.1 Hz	1.0 MHz	1.0 Hz	1.0 MHz	1 μ Hz	1 mHz
Max	5.0 MHz	1.0 MHz	13 MHz	20 MHz	20 MHz	50 MHz	21 MHz-sine	50 MHz
Waveforms (symmetry)								
Sine	50%	50%	20-80%	5-95%	10-90%	10-90%	50%	50%
Square	15/50/85%	50%	20-80%	5-95%	10-90%	10-90%	50%	20, 50, 80%
Transition time	<30 ns	<100 ns	<20 ns	<9 ns	<10 ns	<6 ns	<20 ns	<5 ns
Triangle	15/50/80%	50%	20-80%	5-95%	10-90%	10-90%	50% + ramp	20, 50, 80%
Output (into 50 Ohms)								
Amplitude (p-p)	15 V	10 V	10 V	10 V	16 V	16 V	10 V	20 V
DC Offset	± 5 V	± 5 V	± 5 V	± 5 V	± 8 V	± 8 V	± 5 V	± 5 V
Output Impedance- Ω	50	600	50	50	50	50	50	50/1000
Modes								
Counted Burst	—	—	—	1 to 1999	1 to 1999	1 to 1999	—	1 to 1999
Gate	ext—3310B	—	int/ext	int/ext	ext	ext	—	ext
Phase Lock	—	—	—	± 200 deg	—	—	± 720 deg	ext
Trigger	ext—3310B	—	int/ext	int/ext	ext	int/ext	—	ext
Arbitrary	—	—	—	150 vectors	—	—	—	—
Modulation/Sweep								
AM	—	—	int/ext	ext	—	ext	ext	option
FM	—	—	int/ext	ext	—	ext	PM	ext
PWM	—	—	—	—	—	ext	—	—
VCO	ext	ext	int/ext	ext	ext	ext	—	ext
Lin Sweep	—	—	int/ext	int	—	—	int	—
Log Sweep	—	—	—	int	—	option	int	option
Programmability	—	—	—	HP-IB	—	HP-IB	HP-IB	HP-IB
Notes		into 600 Ω	50% above 1 MHz	also 1/2 cycle bursts	50% above 1 MHz	20-80% above 1 MHz	40 Vp-p to 1 MHz option	



Frequency Synthesizers

Today's measurement needs are placing increasingly stringent requirements on signal sources for greater frequency resolution and stability. Narrowband component testing, satellite and terrestrial communications, local oscillator and automatic test systems are only a few of the many applications that continually require higher precision sources.

Square waves, triangle waves, and pulses are signals typically associated with non-synthesized sources. This situation is changing. Precision signals of these types are finding important applications in mechanical, civil, and environmental engineering.

Increased amplitude accuracy and resolution are also requirements in many applications. The telecommunications industry's Frequency Division Multiplex (FDM) systems require high amplitude accuracy and resolution (0.01 dB) as well as high frequency resolution and stability. These requirements are becoming commonplace in R & D and production test environments.

Frequency Synthesis Techniques

Traditional approaches to indirect synthesis techniques require a phase-locked loop for every decade of frequency resolution. This method provides adequate performance, but many component parts leads to an expensive product. However, a new technique has been developed by Hewlett-Packard that allows a single phase-locked loop to offer multidigit resolution. The process is called Fractional Frequency Synthesis or Fractional N-a method of relating the "VCO" frequency to the crystal reference by other than an integer N. Up to 11 digits of frequency

resolution can be achieved from a single phase locked loop with this new technique. Significant cost savings and increased reliability result.

Signal Quality

The common specifications which describe signal sources include frequency range and resolution, amplitude range and resolution, distortion and stability.

Additional specifications that are pertinent to the synthesizer are phase noise and spurious content. Phase noise describes the short term frequency stability of a signal source. It is typically specified as single sideband spectral density or integrated (total) phase noise. Spurious signals are discrete, nonharmonically related signals appearing in the output.

Synthesizers

Hewlett-Packard offers a wide range of high quality frequency synthesizers and synthesized signal generators covering the frequency range of dc to 26 GHz. In addition to being high performance synthesized signal sources, they incorporate many additional features which allow them to fulfill the needs of either bench or programmable applications.

The combined frequency ranges of the HP 8656A, 8660A/C, 8662A, 8663A, 8672A, and 8673A Synthesized Signal Generators span 10 kHz to 26 GHz. These generators couple the frequency accuracy and stability of synthesizers with the modulation capability and precise, calibrated, wide-range level control of high quality signal generators. In addition, each of these generators offer HP-IB remote control of frequency, level, and modulation.

Synthesized Level Generators

The HP 3335A is a synthesized level generator covering the range of 200 Hz to 80 MHz. This instrument is ideal as a stand-alone generator with synthesizer stability or as a companion generator for the HP 3745A/B SLMS and 3586A/B/C selective level meter. It offers the traditional range of connectors and output impedances, balanced and unbalanced, required by the telecommunications industry. The 3336A/B/C is a 21 MHz synthesized level generator with a similar set of telecommunications features. It too, is ideal as a stand-alone generator or as a companion for HP's 3586A/B/C Selective Level Meter. For more information on these generators, refer to the Telecommunications section.

Sweep Capability

The 3325A, 3330B, 3335A, 3336A/B/C, 8660C, 8662A, and 8663A are among the most linear sweepers ever built. Keyboard control of microprocessors gives these instruments digital control of sweep start/stop frequencies and sweep times.

Synthesizer/Function Generator

The HP 3325A is a function generator whose functions are derived from a primary synthesized oscillator. It provides a high purity synthesized sine wave from 0.000001 Hz to 21 MHz, precision square waves to 11 MHz, linear ramps and triangle waveforms to 11 kHz, 11 digit resolution (1 μ Hz < 100 kHz), wideband phase continuous sweep, and HP-IB programmability. The low price makes the 3325A an excellent choice for automatic test systems or bench applications.

Synthesizer Summary

HP Model	Frequency Range	Frequency Resolution	Frequency Stability	Level Range dBm - 50 Ω	Level Resolution	Remote Control	Other Features*
3325A*** (Pg. 334)	DC-21 MHz (sine) DC-11MHz (square)	.000001 Hz or .001 Hz (11 digits)	5 x 10 ⁻⁶ /yr	-56.02 to +23.98 (sine)	.01 dB or .001 mV to .01V (4 digits)	Freq. Ampl. Sweep & Phase	8, 11, 12, 13
3335A (Pg. 336)	200 Hz-80 MHz	.001 Hz	10 ⁻⁸ /day	-87 to +13	0.01 dB (4 digits)	Freq. & Ampl.	2, 3, 8
3336A/B/C (Pg. 337 and 554)	10 Hz-21 MHz (Pg. 343)	.001 Hz or 11 digits	1.5 x 10 ⁻⁸ /day	-71 to +8	0.01 dB	Freq. Ampl. Sweep & Phase	8, 11, 12, 13
8656A (Pg. 340)	100 kHz to 990 MHz	100Hz or 250 Hz	10 ⁻⁹ /day	-127 to +13	0.1dB	Freq., Ampl. Modulation	8, 14
8660A/C** (Pg. 345)	10kHz to 2600 MHz (3 plug-ins)	1 Hz or 2 Hz (10 digits)	3 x 10 ⁻⁹ /day	-146 to +13	Local: 10 dB steps plus Vernier Remote: 1dB Steps	Freq., Ampl. & Modulation	8660A: 5, 7, 8 8660C: 3, 5, 7, 8
8662A** (Pg. 342)	10 kHz-1280 MHz	0.1 Hz or 0.2 Hz (11 digits)	5 x 10 ⁻¹⁰ /day	-139.9 to +13	0.1 dB (4 digits)	Freq. Ampl. Modulation & Sweep	3, 8, 14
8663A** (Pg. 344)	10 kHz to 2560 MHz	0.1 Hz or 0.2Hz (11 digits)	5 x 10 ⁻¹⁰ /day	-129.9 to +16	0.1dB	Freq. Ampl Modulation Sweep	3, 8, 14 15
8671A (Pg. 359)	2 to 6.2 GHz	1 kHz	5 x 10 ⁻¹⁰ /day	>+ 8	—	Freq., FM Modulation	8, 9
8672A/8673A (Pg. 358)	2 to 18/26 GHz	1, 2, 3, 4 kHz	5 x 10 ⁻¹⁰ /day	-120 to +3/0	Local: 10 dB steps plus Vernier Remote: 1 dB Steps	Freq., Ampl. & Modulation	8, 10
8165A (Pg. 333)	1 mHz to 50 MHz	4 digits	1 x 10 ⁶ /day	10.0 mV to 20 V P-P	3 digits	Modulation & Trigger	3, 8, 10

* Other features: (1) 10⁻⁸/day freq. stability optional, (2) 5 x 10⁻¹⁰/day, (3) digital freq. sweep, (4) digital ampl. sweep, (5) internal AM/FM, ϕ M, (6) External AM, (7) 3 x 10⁻⁹/day stability Opt. 001 (8) HP-IB, (9) External FM, (10) External AM & FM, (11) 5 X 10⁻⁹/week stability optional, (12) external AM & ϕ M, (13) phase continuous sweep, (14) Internal & External AM & FM, (15) Independent and simultaneous A, FM, PM and pulse modulation.

** The 8660A/C, 8662A, 8663A and 8672A are synthesized signal generators. They are discussed in detail in the section labeled "Signal Generators."

*** The 3325A Synthesizer/Function Generator includes squarewaves, positive and negative ramps, and triangle waveforms in addition to sinewaves.

FUNCTION GENERATORS & FREQUENCY SYNTHESIZERS

0.0005 Hz to 5 MHz Function Generators

Model 3310A/B

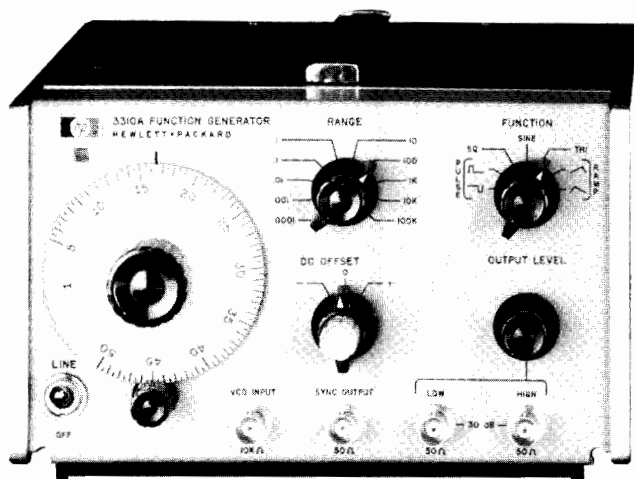

3310A

Description

The 3310A Function Generator is a compact voltage-controlled generator with 10 decades of range. Ramp and pulse functions are available in addition to sine, square and triangle. dc offset and external voltage control provide wide versatility. A fast rise time sync output is provided. Aspect ratio of nonsymmetrical function is 15%/85%.

The 3310B has all the features of the standard 3310A plus single and multiple cycle output capability.

3310A Specifications

Output waveforms: sinusoidal, square, triangle, positive pulse, negative pulse, positive ramp and negative ramp. Pulses and ramps have a fixed 15% or 85% duty cycle.

Frequency range: 0.0005 Hz to 5 MHz in 10 decade ranges.

Sine Wave Frequency Response

0.0005 Hz to 50 kHz: $\pm 1\%$; 50 kHz to 5 MHz: $\pm 4\%$. Reference, 1 kHz at full amplitude into 50 Ω .

Dial Accuracy

0.0005 Hz to 500 kHz all functions: $\pm (1\% \text{ of setting} + 1\% \text{ of full scale})$.

500 kHz to 5 MHz sine, square and triangle: $\pm (3\% \text{ of setting} + 3\% \text{ of full scale})$.

500 kHz to 5 MHz pulse and ramps: $\pm (10\% \text{ of setting} + 1\% \text{ of full scale})$.

Maximum output on high: $> 30 \text{ V p-p open circuit}$; $> 15 \text{ V p-p into } 50 \Omega$ (except for pulses at frequency $> 2 \text{ MHz}$).

Pulse (frequency $> 2 \text{ MHz}$): $> 24 \text{ V p-p open circuit}$; $> 12 \text{ V p-p into } 50 \Omega$.

Minimum output on low: $< 30 \text{ mV p-p open circuit}$; $< 15 \text{ mV p-p into } 50 \Omega$.

Output level control: range $> 30 \text{ dB}$. High and low outputs overlap for a total range of $> 60 \text{ dB}$; low output is 30 dB down from high output.

Sine Wave Distortion

0.0005 to 10 Hz: $> 40 \text{ dB (1\%)}$.

10 Hz to 50 kHz (on 1 k range): $> 46 \text{ dB (0.5\%)}$.

50 kHz to 500 kHz: $> 40 \text{ dB (1\%)}$.

500 kHz to 5 MHz: $> 30 \text{ dB (3\%)}$.

Square wave and pulse response: $< 30 \text{ ns rise and fall times}$ at full output.

Triangle and ramp linearity: 0.0005 Hz to 50 kHz, $< 1\%$.

Impedance: 50 Ω .

Sync

Amplitude: $> 4 \text{ V p-p open circuit}$, $> 2 \text{ V p-p into } 50 \Omega$.

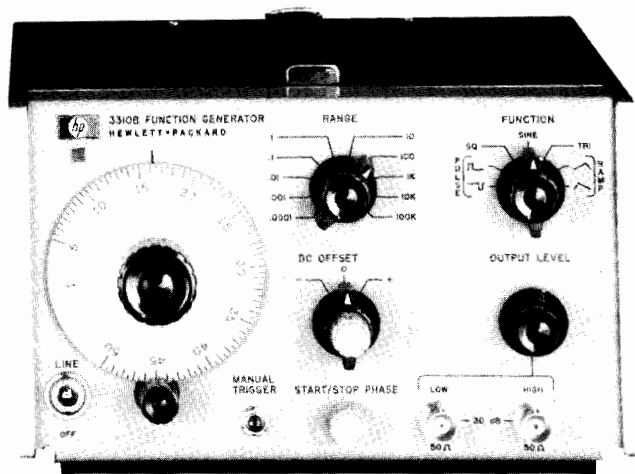

3310B

DC Offset

Amplitude: $\pm 10 \text{ V open circuit}$, $\pm 5 \text{ V into } 50 \Omega$ (adjustable).

Note: max V ac peak + V dc offset is $\pm 15 \text{ V open circuit}$, $\pm 7.5 \text{ V into } 50 \Omega$.

External frequency control: 50:1 on any range.

Input requirement: with dial set to low end mark, a positive ramp of 0 to $+10 \text{ V} \pm 1 \text{ V}$ will linearly increase frequency 50:1. With dial set at 50, a linear negative ramp of 0 to $-10 \text{ V} \pm 1 \text{ V}$ will linearly decrease frequency 50:1. An ac voltage will FM the frequency about a dial setting within the limits $(1 < f < 50) \times \text{range setting}$.

Linearity: ratio of output frequency to input voltage ($\Delta f / \Delta V$) will be linear within 0.5%.

Sensitivity: approximately 100 mV/minor division.

Input impedance: 10 k Ω .

General

Power: 115 V or 230 V $\pm 10\%$, 48 Hz to 440 Hz, $< 20 \text{ VA max}$.

Size: 114 mm H (without removable feet) x 197 mm W x 203 mm D (4.5" x 7.8" x 8").

Weight: net, 2.7 kg (6 lb). Shipping, 4.5 kg (10 lb).

Accessories Available

For rack mounting, order HP 5060-8762 Rack Adapter Frame; 5060-8540, 5060-8760 Filler panels.

3310B Specifications

Same as 3310A with the following additions:

Modes of operation: free run, single cycle, multiple cycle.

Triggered frequency range: 0.0005 Hz to 50 kHz (usable to 5 MHz in normal mode).

Single cycle:** ext trigger (ac coupled) requires a positive-going square wave or pulse from 1 V p-p to 10 V p-p. The triggering signal can be dc offset, but $(V \text{ ac peak} + V \text{ dc}) \leq \pm 10 \text{ V ext gate}$ (dc coupled) will trigger a single cycle on any positive waveform $\geq 1 \text{ V}$ but $\leq 10 \text{ V}$ which has a period greater than the period of the 3310B output, and a duty cycle less than the period of the 3310B output. The gate signal cannot exceed 10 V.

Multiple cycle:** manual trigger will cause the 3310B to free run when depressed. When the trigger button is released, the waveform will stop on the same phase as it started. Ext. gate will cause the 3310B to free run when the gate is held at between +1 and +10 V. When the gate signal goes to zero, the 3310B will stop on the same phase as it started.

Start-stop phase: the start-stop phase can be adjusted over a range of approximately $\pm 90^\circ$.

Ordering Information

3310A Function Generator

3310B Function Generator

**This specification applies on the X.0001 to X.1k range only.

FUNCTION GENERATORS & FREQUENCY SYNTHESIZERS

0.1 Hz to 1 MHz
Model 3311A

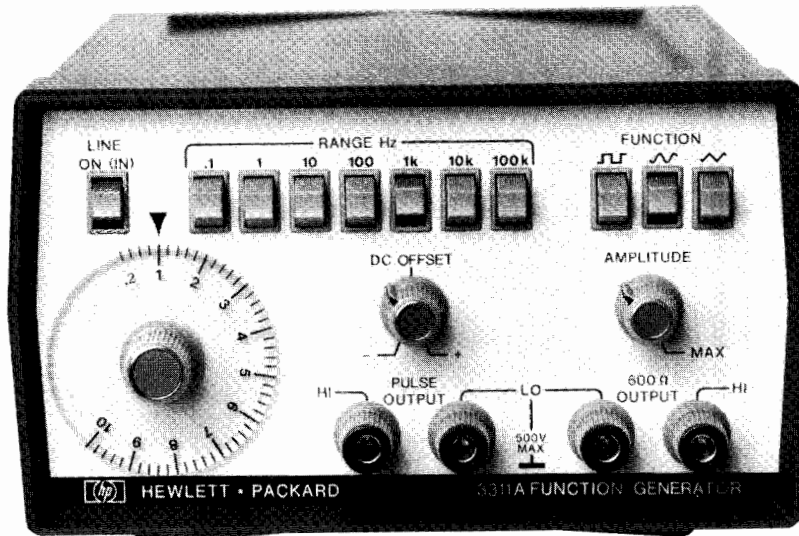

Description

The 3311A Function Generator offers wide functional capability at a modest price. This compact unit has seven decades of range from 0.1 Hz to 1 MHz. Pushbutton range and function selection add convenience to versatility. Added features normally not found on function generators in this price range are 10:1 voltage control and a separate pulse output suitable for synchronization or driving TTL logic circuits.

Output

Ten V p-p into 600 Ω (20 V p-p open circuit). This output may be attenuated by > 30 dB by a variable attenuator and offset by ± 5 V. The dc offset allows the sine, square, and triangle functions to be positioned to the most desired level. This feature adds to the usefulness of all three functions.

VCO

The dc coupled voltage control allows the use of an external source to sweep the 3311A > 10:1 in frequency.

Pulse Output

A separate TTL compatible pulse output provides current sinking for up to 20 TTL loads. The pulse has a 15/85 aspect ratio with a < 25 ns rise time.

Specifications

Waveforms: sinusoid, square, triangle, and positive pulse.

Frequency range: 0.1 Hz to 1 MHz in seven decade ranges.

Dial accuracy: $\pm 5\%$ of full scale.

Isolation: using an external supply, outputs may be floated up to ± 500 V relative to the instrument case (earth ground).

600 Ohm Output

Maximum output amplitude: 20 V p-p open circuit; 10 V p-p into 600 Ω .

Amplitude control: continuously variable, > 30 dB range. DC off-

set: up to ± 10 V open circuit, ± 5 V into 600 Ω , continuously adjustable and independent of amplitude control. Maximum V_{ac} peak + V_{dc} offset without clipping is ± 10 V open circuit, ± 5 V into 600 Ω .

Output impedance: 600 $\Omega \pm 10\%$.

Sine wave amplitude flatness: within $\pm 3\%$ of 10 kHz reference (maximum output amplitude) to 100 kHz, $\pm 6\%$ to 1 MHz.

Sine wave total harmonic distortion: < 3% (maximum output amplitude).

Triangle linearity: deviation < 1% from best straight line at 100 Hz (maximum output amplitude).

Square wave transition time: rise time: < 100 ns; fall time: < 100 ns.

Square wave time axis symmetry error: $\pm 2\%$ maximum to 100 kHz.

Pulse Output

Output amplitude: > 3 V positive (open circuit) TTL compatible.

Duty cycle: 13.5% to 16.5% of the total period.

Transition times: < 25 ns.

External Frequency Control

VCO range: > 10:1 on any frequency range.

Input requirement: with frequency dial set to 1.0, a linear ramp of 0.0 V to -10 V ± 2 V will linearly increase frequency > 10:1

Input impedance: 10 k $\Omega \pm 10\%$ in parallel with < 60 pFd.

General

Operating temperature: 0°C to 55°C; specifications apply from +15°C to +35°C.

Storage temperature: -40°C to +75°C.

Power: 100/120/220/240 V -10%, +5% switchable: 48 Hz to 66 Hz; ≤ 12 VA.

Size: 89 mm H x 159 mm W x 248 mm D (3.5" x 6.3" x 9.8").

Weight: net, 1.5 kg (3.3 lb). Shipping, 2.5 kg (5.5 lb).

Rack mount kits: 10851A for one 3311A, 10852A for two.

3311A Function Generator



FUNCTION GENERATORS & FREQUENCY SYNTHESIZERS

Function Generator

Model 3312A

- Two function generators in one instrument
- AM-FM, sweep, trigger, gate and burst

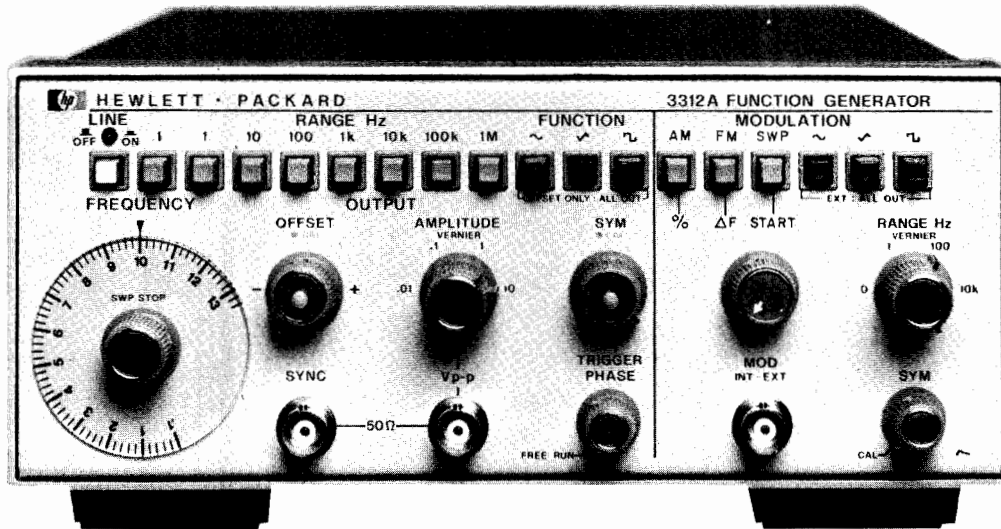

Description

Hewlett-Packard's 3312 A Function Generator combines two separate, independent function generators with a modulator section in one compact instrument.

The main generator can—via pushbutton control—be triggered by the modulation generator to provide sweep functions, AM, FM or tone burst.

Ten V p-p into 50 Ω provides adequate power for most applications. The output attenuator has a range of more than 10,000:1 so clean low-level signals from 10 V to 1 mV p-p into 50 Ω can be obtained. The main generator includes dc offset up to 10 volts p-p into 50 Ω .

Hewlett-Packard's 3312A is an effective low cost solution for generating a multitude of functions.

Specifications

Output waveforms: sine, square, triangle, \pm ramp, pulse, AM, FM, sweep, triggered and gated.

Frequency Characteristics

Range: 0.1 Hz to 13 MHz in 8 decades ranges.

Dial accuracy: $\pm 5\%$ of full scale.

Square wave rise or fall time (10% to 90%): < 20 nsec.

Aberrations: $< 10\%$.

Triangle linearity error: $< 1\%$ at 100 Hz.

Variable symmetry: 80:20:80 to 1 MHz.

Sine wave distortion: $< 0.5\%$ (-46 dB) THD from 10 Hz to 50 kHz. (10 kHz range maximum). > 30 dB below fundamental from 50 kHz to 13 MHz, at full-rated output.

Output Characteristics

Impedance: 50 $\Omega \pm 10\%$.

Level: 20 V p-p into open circuit, > 10 V p-p into 50 Ω at 1 kHz.

Level flatness (sine wave): $< \pm 3\%$ from 10 Hz to 100 kHz at full rated output (1 kHz reference). $< \pm 10\%$ from 100 kHz to 10 MHz.

Attenuator: 1:1, 10:1, 100:1, 1000:1 and > 10 :1 continuous control.

Attenuator error: $< 5\%$.

Sync output: impedance: 50 $\Omega \pm 10\%$, > 1 V p-p square wave into open circuit. Duty cycle varies with symmetry control.

DC offset: variable up to ± 10 volts. Instantaneous ac voltage + Vdc offset cannot exceed ± 10 V (open circuit) or ± 5 V (terminated 50 ohm).

Modulation Characteristics

Types: internal AM, FM, sweep, trigger, gate or burst; external AM, FM, sweep, trigger, gate or burst.

Waveforms: sine, square, triangle, ramp or variable symmetry pulse.

Frequency range: 0.01 Hz to 10 kHz.

Output level: > 1.0 V p-p into 10 k Ω .

Amplitude Modulation

Depth: 0 to 100%.

Modulation frequency: 0.01 Hz to 10 kHz (internal). DC to > 1 MHz (external).

Carrier 3 dB bandwidth: < 100 Hz to > 5 MHz.

Carrier envelope distortion: $< 2\%$ at 70% sine wave modulation with $f_c = 1$ MHz, $f_m = 1$ kHz.

External sensitivity: < 10 V p-p for 100% modulation.

Frequency Modulation

Deviation: 0 to $\pm 5\%$ (internal).

Modulation frequency: internal: 0.01 Hz to 10 kHz; external: DC to > 50 kHz.

Distortion: < -35 dB at $f_c = 10$ MHz, $f_m = 1$ kHz, 10% modulation.

Sweep Characteristics

Sweep width: > 100 :1 on any range.

Sweep rate: 0.01 Hz to 10 kHz, 90:10 ramp, and 0 Hz Range (provides manual setting of "Sweep Start" without modulation generator oscillating).

Sweep mode: repetitive linear sweep between start and stop frequency settings. Retrace time can be increased with symmetry control.

Ramp output: 0 to > -4 p-p into 5 k Ω .

Gate Characteristics

Start/stop phase range: $+90^\circ$ to -80° .

Frequency range: 0.1 Hz to 1 MHz (useful to 10 MHz).

Gating signal frequency range (external): dc to 1 MHz, TTL compatible.

External Frequency Control

Range: 1000:1 on any range.

Input requirement: with dial set at 10, 0 to -2 V $\pm 20\%$ will linearly decrease frequency > 1000 :1. An ac voltage will FM the frequency about a dial setting within the limits ($0.1 < f < 10$) x range setting.

Linearity: 0.5% of Fmax for $F_{max} \leq 1$ MHz 5.0% of Fmax for $F_{max} > 1$ MHz. Deviation is from a best fit straight line. VCO frequency span ≤ 100 :1.

Input impedance: 2.8 k $\Omega \pm 5\%$.

General

Operating temperature: 0°C to $+55^\circ\text{C}$; specifications apply from 0°C to 40°C .

Storage temperature: -40°C to $+75^\circ\text{C}$.

Power: 100 V, 120 V, 220 V, 240 V $+5\%$, -10% , switchable; 48 Hz to 440 Hz; ≤ 25 VA.

Size: 102 mm H x 213 mm W x 377 mm D (4" x 8.4 x 14.8").

Weight: net, 3.8 kg (8.4 lb). Shipping, 5.9 kg (13 lb).

3312A Function Generator

FUNCTION GENERATORS & FREQUENCY SYNTHESIZERS

1 mHz to 20 MHz Function Generator with Arbitrary Waveforms

Model 3314A



- Lin/Log sweeps
- AM/FM/VCO
- Phase lock $\times N$ and $\div N$

- Gate and counted burst
- 1/2 cycle mode
- Arbitrary waveform generator



3314A Multi-Waveform Generator

The 3314A is a Function/Waveform Generator with the precision and versatility to produce numerous waveforms. Its feature set includes accurate sine, square, and triangle waves, with ramps and pulses available using variable symmetry. Additional features include counted bursts, gate, lin/log sweeps, AM, FM/VCO, DC offset, and phase lock. For increased versatility, the Arbitrary waveform mode allows a countless number of user defined waveforms. Since complete programmability is provided, all of these capabilities are available for ATE systems, as well as bench applications.

Precise Functions

The 3314A provides sine, square, and triangle waveforms from 0.001 Hz to 19.99 MHz with an amplitude range of 0.01 mV to 10 V_{p-p} into 50 Ohms, with optional 30 V_{p-p} into > 500 Ohms.

Continuous waveforms are provided with high accuracy and low distortion, with frequency accuracy on the upper ranges of 0.01% and sine distortion < -55 dBc to 50 kHz.

Pulses and ramps are provided to 2 MHz using the variable symmetry control over the full 5% to 95% symmetry range. This provides narrow pulses with 9 nsec rise/fall times for digital circuit testing, and positive or negative ramps for amplifier testing and process control.

Independent dc offset to ± 5 V (into 50 Ohms) can be added to any ac signal. A post-attenuator summing technique is used providing large ac signals with small offsets and vice versa.

Burst and Gate

The 3314A's N Cycle burst mode generates an integer number of complete cycles at each trigger. Bursts of 1 to 1999 cycles are possible for use in applications ranging from sonar testing to digital circuits. Variable symmetry and start/stop phase can be used to produce single ramps and haverswaves.

Like burst mode, gate mode can be triggered internally or externally. In gate, the 3314A output consists of complete cycles, pulses or Arb's which start when the trigger is true, and stop after the trigger goes false. In gate and burst modes, the full frequency range applies for sine, square, triangle, pulse, and ramp waveforms.

New 1/2 Cycle and "Integer" Phase Lock Modes

The new 1/2 Cycle burst mode allows simulation of specialized signals found in electronics. At each trigger, alternating 1/2 cycles of sines or triangles are produced. With the addition of variable start/stop phase and symmetry, pulses with variable rise/fall time and overshoot can be produced. Repetition rate, 1/2 cycle frequency, symmetry, and phase can be set independently to produce a variety of waveforms.

The Fin \times N Fin \div N modes provide powerful phase locking capability. With "integer" phase lock, fractions or multiples of the reference signal can be provided, and ± 200 deg of phase offset is available. Since the 3314A phase locks to the plus or minus edge of the trigger signal, it can lock to a variety of signals such as sines, squares, pulses, ramps, and others—with complete control of output function, symmetry, N, phase, amplitude and offset.

Modulation and Sweep

Complete AM, FM/VCO modulation give the 3314A versatile signal modifying capabilities. With 100 kHz bandwidths, AM and FM/VCO can be used separately or simultaneously to produce a multitude of waveforms.

Multi-frequency measurements can be made with the 3314A's sweep capabilities. Linear, logarithmic, and manual sweep make measurements of filters, amplifiers, and other networks convenient and accurate. X drive, marker, and trigger output signals are also provided.

Arbitrary Waveforms

For specialized low frequency applications, the 3314A's Arbitrary (ARB) waveform mode lets you create custom waveforms as a series of voltage ramps or vectors. Values are easy to enter from the front panel using the modify knob as a "pencil" and an oscilloscope as a "pad". For remote programming, use a desktop or mainframe computer to calculate the values, then program them using the HP-IB. Arb waveforms are automatically stored in non-volatile memory for quick recall.

Two Sources in One

A square wave trigger source is included for generation of complex waveforms with a single 3314A. The 0.5 mHz to 500 kHz internal trigger is useful in gated, burst, and phase locked waveforms. This signal is provided as an output for synchronizing the 3314A to other devices.

Source for your System

Because all front panel controls are programmable, the 3314A's precision and versatility can be utilized in automated test systems.

System efficiency can be improved with standard features such as Service Request (SRQ) interrupt capability and buffered transfer mode.

In production test environments, the 3314A's Query commands can be used when an operator and computer are sharing control of the instrumentation. Parameters can be read from the 3314A into the computer where its computational capabilities can be utilized.

FUNCTION GENERATORS & FREQUENCY SYNTHESIZERS

1 MHz to 20 MHz Function Generator with Arbitrary Waveforms

Model 3314A (cont.)

Arbs Made Easy

With complete control of each vector, the modify knob is used as a "pencil" to draw the waveform on an oscilloscope.

1. After ~20 unit vectors have been inserted, use modify to set the marker, VMKR, to #1. Then set the height of #1 to 400.

2. Press V LEN and use modify to set the length to 3.

3. Press V HGT twice, and set the height of #2 to -190.

4. Continue to use V HGT and V LEN to create the desired waveform, and INS (insert) or DEL (delete) vectors as needed. Amplitude and frequency can now be set without affecting the vector values. Waveform parameters are automatically stored in non-volatile memory while they are being created.

5. Later, if a slightly different waveform is needed, just use the marker to select an individual vector, and modify its height and length without affecting the height and length of other vectors!

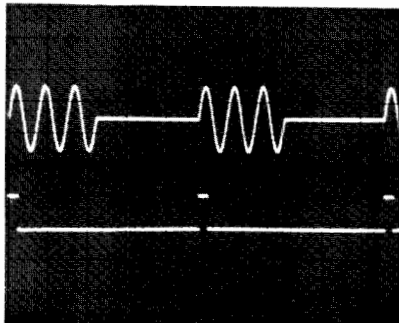
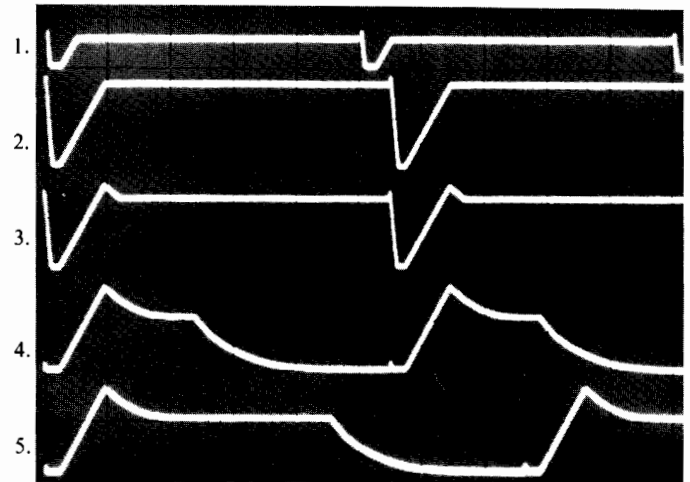

Counted burst with ext. trigger

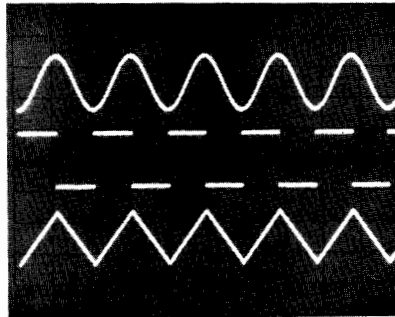

Sine, square, and triangle to 20 MHz

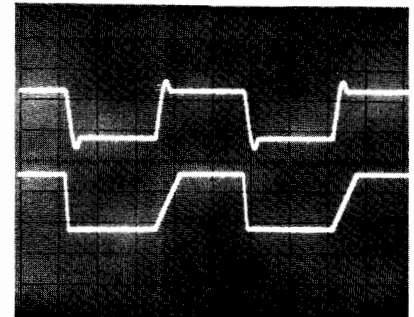

1/2 cycle mode simulating overshoot and variable rise/fall pulses

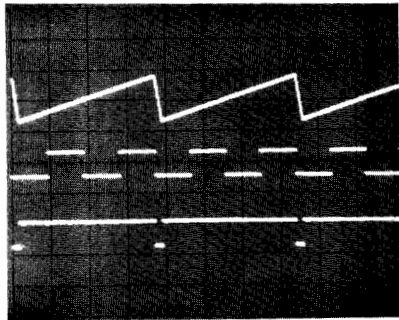

Ramp output phase locked to internal trigger. Shown with sync output.

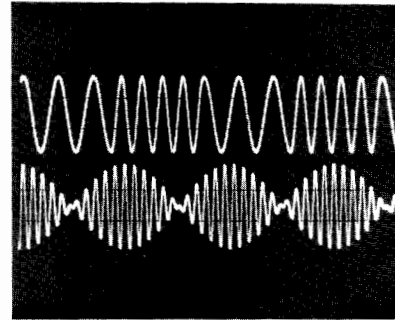

FM and AM (suppressed carrier)

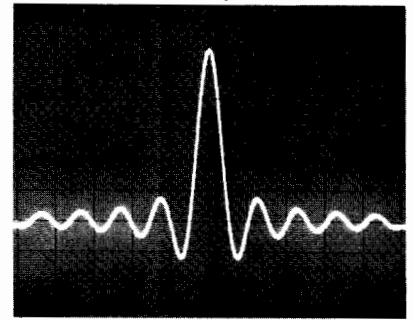

$\frac{\text{sine } x}{x}$ using ARB's

Specifications

Frequency

Frequency range: 0.001 Hz to 19.99 MHz-sine, square and triangle waveforms, 0.001 Hz through 2 MHz range when symmetry \neq 50%

Resolution: 3½ digits

Frequency Accuracy

HP-IB #	Range	Minimum Frequency		Maximum Frequency	Accuracy
		Range Hold	Autorange		
1	2 Hz	.001 Hz	.001 Hz	1.999 Hz	±(0.4% setting + 0.2% range)
2	20 Hz	0.01 Hz	1.50 Hz	19.99 Hz	
3	200 Hz	0.01 Hz	15.0 Hz	199.9 Hz	
4	2 kHz	0.01 kHz	150. Hz	1999. Hz	±(0.2% setting + 0.1% range)
5	20 kHz	0.01 kHz	1.50 kHz	19.99 kHz	
6	200 kHz	0.01 kHz	15.0 kHz	199.9 kHz	
Synthesized					
7	2 MHz	0.01 MHz	150. kHz	1999. kHz	±(0.01% setting +50 ppm/year)
8	20 MHz	0.01 MHz	1.50 MHz	19.99 MHz	

Accuracy applies in the Free Run mode, with VCO Off, and Symmetry = 50% (Fixed)

Amplitude

Amplitude range: 0.01 mVp-p to 10 Vp-p into 50 Ω

Resolution: 3½ digits

HP-IB #	Range	Minimum	Maximum	Step Attenuator
1	10 mV	0.01 mV	10.00 mV	60 dB
2	100 mV	10.0 mV	100.0 mV	40 dB
3	1 V	.100 V	1.000 V	20 dB
4	10 V	1.00 V	10.00 V	0 dB

Absolute Amplitude Accuracy

±(1% of display + 0.035 Vp-p), sine and square wave
±(1% of display + 0.06 Vp-p), triangle

Amplitudes: 1.00 Vp-p to 10.00 Vp-p (Range 4)

Frequency: 10 kHz, Autorange ON

Flatness-sine wave: relative to 10 kHz, 1.00 V to 10.0 V (Range 4)

20 Hz	50 kHz	1 MHz	19.99 MHz
.07 dB	.33 dB	1.5 dB	



Frequency Sweep

	Range (decades)	Start Freq	Stop Freq	Sweep Time
linear	0 to 2	$\geq .001$ Hz	≤ 19.99 MHz	7.2 ms to 1999 s/sweep
log	1 to 7 (integer only)	$\geq .2$ Hz	≤ 19.99 MHz	40 ms to 1999 s/decade

Manual Sweep

Modify knob tunes between start and stop frequencies. X drive follows sweep.

X Drive Start/Stop Voltage

-5 V to +5 V into 1 K Ω load

Z Axis Output

Blanking Pulse, $> +5$ V

Baseline, 0V ± 1 V

Marker Pulse, < -5 V into 1 K Ω load

Modulation Inputs

	Bandwidth	Sensitivity	Range	Z
AM	dc to 100 kHz	2 Vp-p for 100% -1 Vdc for suppressed carrier	$> 100\%$	10 k Ω
FM	100 Hz to 100 kHz	± 1 Vp for $\pm 1\%$ of range deviation	1%	10 k Ω
VCO	dc to 100 kHz	10%/Volt	+1 to -10V	10 k Ω

Waveform Characteristics

Sine Harmonic Distortion

Individual harmonics will be below these levels, relative to the fundamental. Offset = 0V. Function Invert = OFF. Range Hold = OFF.

20 Hz	50 kHz	1490 kHz	19.99 MHz
-55 dB*	-40 dB	-25 dB	

* add 4 dB for ambient temperature 0 to 5°C and 45 to 55°C, 20 Hz to 50 kHz

Square Wave Rise/Fall Time

< 9 ns, 10% to 90% at 10 Vp-p output

N Integer

N = 1 to 1999, Preset to 1

For Phase-lock Fin \div N, Fin \times N

or N CYCLE (counted burst)

Function Invert

Inverts ac portion of signal outputs

Sine, square, triangle, ramp, pulse, and ARBs

Does not affect Sync and Trigger outputs or dc offset setting

Phase

Phase Offset—Phase Lock Modes

Resolution: 0.1°

Range: $\pm 199.9^\circ$

Accuracy: $\pm 2^\circ$ (50 Hz to 15 kHz)

Phase Offset is Referenced to

signal output for Fin \div N

signal input for Fin \times N

Start/Stop Phase—Burst Modes

Resolution: 0.1°

Range: $\pm 90.0^\circ$ for frequencies to 19.99 MHz

Accuracy: $\pm 3^\circ$ (applies from .001 Hz to 1 kHz)

Trigger

Internal Trigger

Range: .002 ms (500 kHz) to 1999 s (.5 mHz) square wave.

Period Accuracy:

$\pm (0.01\% + 50 \text{ ppm/year})$ of displayed interval (excluding sweep intervals)

Trigger output: low $< .5$ V, high > 2.5 V Output Resistance 1 k Ω

External Trigger

For Gate, N Cycle, $\frac{1}{2}$ Cycle, Fin \times N, Fin \div N, and external sweep triggers

Frequency range: 50 Hz to 20 MHz

Trigger slope: selectable-positive or negative

Trigger level: Selectable to 0 V or +1 V

Trigger level hysteresis: ± 0.15 V

Input Resistance = 1 k Ω

Symmetry

Symmetry range: 5% to 95% of period

Frequency range: 2 Hz to 2 MHz ranges

Arbitrary Waveforms

Output consists of a series of voltage ramps called Vectors. Arbitrary Waveforms can be comprised of 2 to 150 Vectors. A maximum of 160 Vectors can be stored in six available storage registers with a minimum of 2 vectors per waveform (#1 and return-to-start vectors).

Waveform Parameters

Key	Range	Description
Δt	.2 ms to 19.99 ms	sets the time value for each unit of V LEN (length)
V HGT	0 to ± 1999	sets the relative height of an individual vector
V LEN	1 to 127	sets the length in time of an individual vector in integral multiples of Δt
V MKR	1 to 150	marker is used to select an individual vector
INS		insert is used to add a vector before the marker location
DEL		deletes the vector at marker location
FREQ	.002 Hz to 2.5 kHz	$\text{Freq} = \frac{1}{\Delta t(VLEN_1 + VLEN_2 + \dots VLEN_n)}$
AMPTD	.01 mV to 10 Vp-p	sets amplitude window for ARB waveform
OFFSET	0 to ± 5 Vdc	offsets the ARB waveform independent of AMPTD setting
PHASE	$+90^\circ$ to -90°	sets wave start/stop voltage within the window defined by AMPTD

Marker output: located on Z axis rear panel connector

Sync output: low during the return-to-start vector

Gate mode: allows external gating of ARB output-complete ARB waveforms only

Option 001

Simultaneous $\times 3$ output (into $> 500 \Omega$).

30 Vp-p max, DC to 1 MHz.

General

Specifications Apply When

Main signal output terminated into $50 \pm 0.1 \Omega$

Warm-up > 30 min

Within $\pm 5^\circ\text{C}$ and 24 hours of last internal calibration

Temperature: 0 to 55°C

Relative humidity: $< 95\%$ at 40°C

Altitude: $< 15,000$ ft

Storage temperature: -40 to $+75^\circ\text{C}$

Power

100/120/220/240 V $\pm 5\%$ -10% , 48 to 66 Hz

90 VA maximum

Weight: net, 7.3 kg (16 lb). Shipping, 10.5 kg (23 lb).

Dimensions: 132.6 mm (5.22 in) H \times 212.3 mm (8.36 in) W \times 419.0 mm (16.50 in) D

HP-IB

IEEE Standard 488-1978 abbreviated definition

SH1 AH1 T6 TE0 L3 LE0 SRI RL1 PPO DC1 DT1 C0 E2

Accessories Included

11048C 50 Ω feed-through termination

50 $\pm .1 \Omega$

Accessories

Transit case for one 3314A

HP P/N9211-2677

Ordering Information

3314A Function Generator

Option 001: simultaneous X3 output



FUNCTION GENERATORS & FREQUENCY SYNTHESIZERS

1 Hz–20 MHz Pulse/Function Generator

Model 8111A

- Sine, triangle, square, haverfunctions
- 20 MHz, 32 Vpp for all waveforms
- Variable duty cycle or pulse width
- Trigger, gate, VCO and optional burst
- Digital display for all parameters
- Error recognition

Picture shows 8111A with Option 001, Counted Burst.



The 8111A combines pulse generator and function generator capabilities in a single, compact unit. Triggered operation for all waveforms, and the ability to define rectangular waveforms in terms of pulse width or duty cycle, are examples of the 8111A's versatility.

Saves Space and Equipment

Small size and manifold capability make the 8111A an ideal source for service and bench. Digital display, error detector and good repeatability assure high operating confidence. This reduces the need for output monitoring and consequently saves equipment.

Flexible

Operating modes include VCO which permits frequency-shift keying and dc-to-frequency conversion as well as sweep and FM applications. Option 001's Burst mode simplifies tone burst generation and digital preconditioning by generating a precise number of waveform cycles. An "extra cycle" feature activated after a burst allows critical events to be examined.

Pulse mode's variable width down to 25 ns and clean 10 ns transitions provide useful digital test capability. High analog flexibility is assured because all waveforms can be generated in trigger, gate and burst modes. Adjustable duty cycle up to 999 kHz means that CRT sawtooth waveforms and rectangular signals for dc motor control can be simulated.

Specifications (50-ohm load resistance)

Waveforms

sine, triangle, ramp, square, pulse, haverfunctions.

Timing

Frequency

Range: 1.00 Hz to 20.0 MHz (3-digit resolution).

Accuracy (50% duty cycle): 5% ($\pm 10\%$ below 10 Hz).

Jitter: $< 0.1\% + 50$ ps.

Stability: $\pm 0.2\%$ (1 hour), $\pm 0.5\%$ (24 hours).

Duty Cycle (sine, triangle, square, haverfunctions):

	Calibrated	Variable (below 1 MHz)
Range:	50% nominal	10% to 90%.
Resolution:	2 digits	2 digits
Accuracy:	± 1 digit	± 6 digits (± 3 in range 20 to 80%).

Pulse Width

Range: 25.0 ns to 100 ms (3-digit resolution).

Accuracy: $\pm 5\% \pm 2$ ns.

Output Characteristics

(voltages double into high impedance)

Amplitude

Range: 1.60 mVpp to 16.00 Vpp (3½ digit resolution).

Accuracy: $\pm 5\%$ (at 1 kHz for sine and triangle).

Flatness (sine, triangle): $\pm 3\%$ (+10%, -15% above 1 MHz).

Offset

Range: 0.00 mV to ± 8.00 V (3-digit resolution).

Accuracy: $\pm 0.5\%$ setting $\pm 1\%$ ampl ± 20 mV

(ampl ≥ 160 mVpp),

$\pm 0.5\%$ setting $\pm 1\%$ ampl ± 1 mV

(ampl < 160 mVpp).

Distortion: THD (1 Hz–1 MHz) $< 3\%$ (-30 dB); harmonics (1 MHz–20 MHz) < -26 dB. Distortion may increase by 3 dB below 10°C and above 45°C .

Linearity (triangle): $< \pm 3\%$ ($< \pm 1\%$ below 1 MHz)

Pulse and Squarewave Performance

Transitions: < 10 ns.

Perturbations: $< \pm 5\%$ ($< \pm 10\%$ below 0.16 Vpp).

Output impedance: ± 50 ohm $\pm 5\%$.

Modes

normal, trigger*, gate*, VCO and (Option 001) burst*.

*Adjustable start-phase for haversine, havertriangle

VCO range: 2 decades, ext. signal 0.1 V to 10 V (dc to 1 kHz).

Burst length: 1 to 1999 periods for all waveforms.

General

Repeatability: factor 2.5 better than accuracy.

Environmental

Storage temperature: -40°C to $+75^\circ\text{C}$.

Operating temperature: 0°C to 55°C .

Humidity: 95% RH, 0°C to 40°C .

Power: 100/120/220/240 V rms; $+5\% - 10\%$; 48 to 440 Hz; 70 VA max.

Weight: net, 4.6 kg (10 lb). Shipping, 6.6 kg (15 lb).

Size: 89 H x 212.3 W x 345 mm D (3.5" x 8.36" x 13.6").

Ordering Information

8111A Pulse/Function Generator

Opt 001: Burst

Opt 910: Extra Operating and Service Manual

5061-2001: Bail Handle Kit

5061-0072 Rack Mount Kit (single 8111A)

5061-0074 Rack Mount Kit (two instruments)

5061-0094 Lock Link Kit (for use with 5061-0074)

FUNCTION GENERATORS & FREQUENCY SYNTHESIZERS

1 MHz–50 MHz Pulse/Function Generator

Model 8116A

331



- Sine, triangle, square, haversine functions and dc
- 1 MHz–50 MHz, 32 Vpp for all waveforms
- Variable (10 ns min) pulse width, 6 ns transitions
- Wide range of operating capability
- Self-prompting operating concept
- Error recognition and self test



Picture shows 8116A with Option 001, Burst and Logarithmic Sweep.

The fully programmable 8116A features pulse as well as function generator capabilities in one small unit. A broad 1 MHz–50 MHz band for all waveforms and a wide choice of operating and modulating modes assure high flexibility. These factors, plus good repeatability, make the 8116A a sound, long-term investment.

Unique Operating Concept Saves Engineering Time

HP's custom IC's have made it feasible to put the many 8116A capabilities into such a small volume. Handling is simplified by a unique, microprocessor-controlled, operating concept which ensures a clear overview of the compact front panel at all times. When the mode and waveform have been selected, illuminated labels show which parameters must be set. There's no clutter, no confusion.

Auto vernier. In normal mode, the 8116A's auto-vernier increments any desired parameter continuously until a stop signal is applied. This means that thresholds can be measured automatically, without a controller.

Level or amplitude programming. The 8116A's output can be programmed in terms of high and low levels or in terms of amplitude and offset. Consequently a direct, automatic, conversion is always feasible so that the 8116A can be programmed in the same terms as the device is specified.

Safe limit. Devices can be protected by the limit feature. This prevents the output from exceeding a given magnitude.

Rectangular Waveforms

For applications such as laser diodes or dc motors, square waves can be programmed for constant duty cycles from 10% to 90%. For digital test, or for simulating very low duty-cycle events, pulse width can be programmed down to 10 ns. Square wave and Pulse modes provide clean 6 ns edges that are ideal for many technologies. Pulse width modulation and pulse recovery capability are available in Pulse mode.

Sine and Triangle Functions

10% to 90% duty cycle, programmable in 1% steps, provides ramps and asymmetrical sine waves for testing VCO's, servos, amplifier linearity and industrial process control systems. Haversine functions,

available in External Trigger, Gate and Burst modes, extend the applications to areas such as telephone line and vibration testing.

Modulation

All waveforms can be amplitude or frequency modulated. VCO operation allows frequency variation over two decades with an external voltage; consequently transducer output can be conditioned for mag tape recording, or frequency-shift keying or linear sweep can be carried out.

Option 001

10 1/2-decade log sweep. Sweep mode covers the wide 1 MHz–50 MHz band in a single up sweep. Test setups require no more than an X-Y recorder or scope because all necessary control signals are available. The 8116A sweeps can be internally triggered, if desired.

Accurate, counted bursts. A preprogrammed number of cycles of any waveform can be generated in Burst mode. With sine, triangle and square functions, bursts can be triggered internally as well as externally.

Hold capability. For material stress testing, low frequency functions can be held at instantaneous levels. Hold is controlled by an external signal.

Low-Cost Automation for Bench and Systems

Powerful capability, small size and wide specified temperature range make the 8116A a good choice for automatic test systems. Also, the low cost means that it's now realistic to automate those routine bench jobs and leave more time for design. Comfortable software features such as easy syntax and flexible format contribute to rapid system design.

Operating Confidence

There's reliance in the 8116A's output because proper operation is always ensured by the instrument's error detector. This helps the user to recover from an incorrect front panel or programming operation by indicating the offending parameter. Also, the built-in test and diagnosis feature verifies correct function each time the instrument is switched on.

Specifications overleaf



FUNCTION GENERATORS & FREQUENCY SYNTHESIZERS

1 MHz–50 MHz Pulse/Function Generator

Model 8116A (cont.)

Specifications

Specifications apply with 50-ohm load and temperatures in the range 0°C to 55°C.

Functions

Sine, triangle, ramp, square, pulse, haversine, havertriangle, dc.

Timing

Frequency

Range: 1 mHz to 50 MHz (3-digit resolution).

Accuracy¹ (pulse mode, 50% d/c): $\pm 3\% \pm 0.3$ mHz below 100 kHz, $\pm 5\%$ above 100 kHz.

Jitter (pulse mode, 50% d/c): $< 0.1\% + 100$ ps.

Stability: $\pm 2\%$ (1 hour), $\pm 5\%$ (24 hours).

Duty cycle: (sine, triangle, square, haversine, havertriangle).

Range: 10% to 90% (20% to 80% above 1 MHz), 2-digit resolution.

Accuracy¹: ± 0.5 digits (± 3 digits above 1 MHz).

Pulse Width

Range: 10.0 ns to 999 ms (3-digit resolution).

Accuracy¹: $\pm 5\% \pm 2$ ns.

Jitter: $< 0.1\%$ ($0.2\% + 200$ ps for width ≤ 10 μ s).

Output Characteristics

(voltages double into high impedance).

Amplitude

Range: 10.0 mV_{pp} to 16.0 V_{pp} (3-digit resolution).

Accuracy¹: $\pm 5\%$ (at 1 kHz for sine and triangle).

Flatness (sine): $\pm 3\%$ ($\pm 5\%$ above 1 MHz, $+5$ – 15% above 10 MHz).

Flatness (triangle): $\pm 3\%$ ($\pm 5\%$ above 1 MHz, $+5$ – 25% above 10 MHz).

Offset and dc Mode

Range: 0.00 to ± 7.95 V (0 to ± 795 mV for amplitude < 100 mV_{pp}).

Resolution: 3 digits.

Accuracy¹: 0.5% of setting $\pm 1\%$ of ampl ± 40 mV ($+2$ mV if ampl < 100 mV_{pp}, ± 20 mV in dc mode).

Distortion (sine, normal mode, 50% duty cycle).

Total harmonic distortion (10 Hz–50 kHz): $< 1\%$ (-40 dB)*.

Harmonic related signals (50 kHz–1 MHz): < -34 dB,
(1 MHz–50 MHz): < -23 dB*.

* May increase by 3 dB below 10°C and above 45°C.

Non-linearity (triangle, ramp, 100 mHz–1 MHz): $< \pm 3\%$.

Pulse and Square Wave Characteristics

Transitions: < 6 ns.

Pulse perturbations: $< \pm 5\% \pm 2$ mV.

Output impedance: 50 ohm $\pm 5\%$.

Operating Modes

Normal, trigger*, gate*, external width.

Additional Modes in 8116A Option 001

Logarithmic Up Sweep (for all waveforms).

Range: Start and stop frequencies selectable up to full range (1 mHz–50 MHz).

Sweep time: selectable in 1-2-5 sequence from 10 ms to 500 seconds per decade.

Sweep repetition: continuous sweeps (internal sweep) or externally triggered.

Counted Burst* (for all waveforms).

Burst length: 1 to 1999 cycles.

Burst repetition: internally triggered at selectable intervals from 100 ns to 999 ms (except in Pulse mode), or externally triggered, up to 40 MHz.

* Selectable (-90°) start-phase for haversine, havertriangle.

Control Modes

Frequency modulation: $\pm 5\%$ max deviation.

Sensitivity: 1 V for 1% deviation.

Modulating frequency: dc to 20 kHz.

Amplitude Modulation

Sensitivity: ± 2.5 V for 100% mod. ($+2.5$ V to -7.5 V for DSBS).
Modulating frequency: dc to 1 MHz.

¹ Applies from 15°C to 35°C, %-error increases 0.05 per °C outside this range.

Pulse Width Modulation

Range: 10 ns to 1 s in 8 non-overlapping decade ranges.

Max. width ratio: 10:1.

Sensitivity: ± 9 V for 1:10 ratio.

Voltage-Controlled Oscillator

Range: 2 decades in range 1 MHz–50 MHz.

Sensitivity: 0.1 V to 10 V for 2 decades.

Modulating frequency: dc to 1 kHz.

Auxiliary Modes

Manual: simulates external input.

1 cycle (option 001): triggers single output cycle in Trigger, Gate and Ext Burst modes.

Auto vernier: continuous vernier which can be remotely or manually stopped.

Limit: programmable maximum output levels to protect DUT.

Complement: selectable normal/complement output.

Disable: relay disconnects output.

Auxiliary Inputs and Outputs

External Input

Threshold: ± 10 V adjustable.

Max input voltage: ± 20 V.

Sensitivity: 500 mV_{pp}.

Min pulse width: 10 ns.

Input impedance: 10 k Ω typ.

Trigger slope: positive, negative and off.

Control Input

Max input voltage: ± 20 V.

Input impedance: 10 k Ω typ.

Trigger Output

Output levels: 0/2.4 V typ.

Output impedance: 50 ohm typ.

X-Output (Option 001) for sweep X-Y recording (rear panel).

Output levels: 0 V (= start frequency) to 10 V max.

Slope: 1.5 V per sweep decade.

Marker Output (Option 001) for sweep (rear panel).

Output levels: TTL

Leading edge: positive at selected marker frequency.

Hold Input (Option 001), rear panel.

Input levels: TTL

Leading edge: positive transition causes 8116A output ($f < 10$ Hz) to hold at instantaneous level. Output droop 0.01% per second.

Max input voltage: ± 20 V

HP-IB Capability

All manual key operations are programmable. Talk mode provides learn, status byte and error report capabilities.

Memory

Battery-backup RAM retains current operating state.

General

Repeatability: factor 4 better than accuracy.

Environmental

Storage temperature: -40°C to $+70^\circ\text{C}$.

Operating temperature: 0°C to 55°C .

Humidity: 95% RH, 0°C to 40°C .

Power: 100/120/220/240 V rms; $+5\%$, -10% ; 48 to 440 Hz; 120 VA max.

Weight: net, 5.9 kg (13 lb). Shipping, 8.0 kg (18 lb).

Size: 89 H x 212.3 W x 422 mm D (3.5" x 8.36" x 16.6").

Ordering Information

8116A Programmable Pulse/Function Generator*

Opt 001: Burst and Logarithmic Sweep

Opt 910: Extra Operating & Service Manual

5061-2001: Bail Handle Kit

5061-0072: Rack Mount Kit (single 8116A)

5061-0074: Rack Mount Kit (two instruments)

5061-0094: Lock Link Kit (for use with 5061-0074)

* HP-IB cables not supplied, see page 37.

FUNCTION GENERATORS & FREQUENCY SYNTHESIZERS

50 MHz Programmable Signal Source

Model 8165A

333



- Pulse/function capability
- Sine, triangle, square to 50 MHz
- Pulses and ramps to 20 MHz
- Trigger, gate and counted burst
- Synthesizer stability, precision amplitude
- Storage of operating parameters

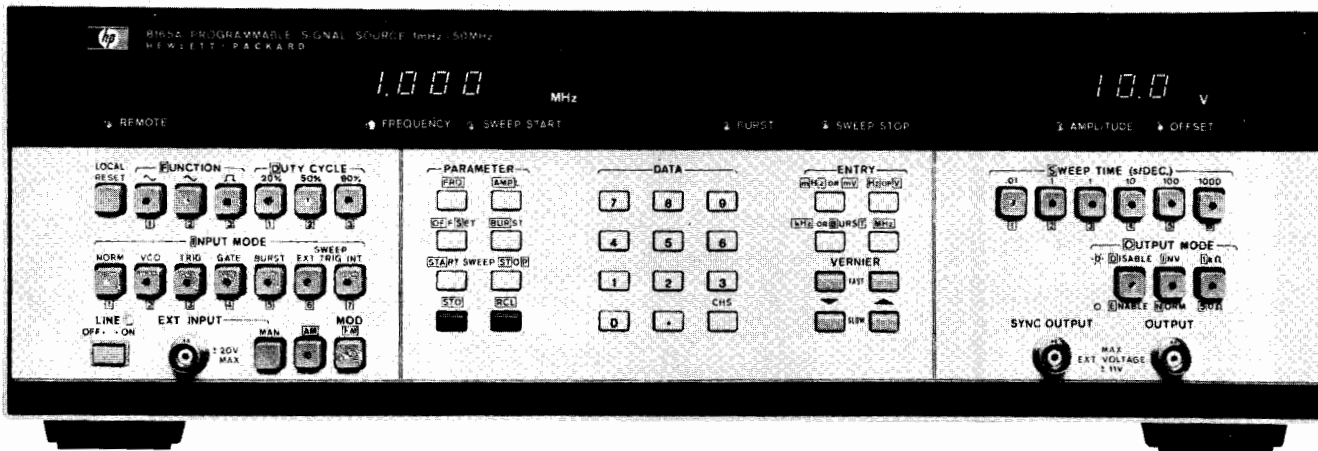

Picture shows 8165A with option 002, AM and Logarithmic Sweep.

Versatility and Simplicity for Systems and Bench

The 8165A Programmable Signal Source is a versatile function generator with good accuracy and many trigger features. Micro-processor control assures rapid, accurate setup whether programming locally or via HP-IB.

Operating Set Storage

Ten complete sets of operating information can be stored and recalled. In the event of power failure, battery back up retains all data plus the active settings.

Stability and Resolution

Very stable frequency is ensured with phase lock loop techniques and internal crystal reference. The four-digit frequency display means a 1 μ Hz resolution in the 1 to 9.999 MHz range.

Specifications

Waveforms and Frequency Range

Sine, square, triangle (50% duty cycle): 1.000 mHz to 50.00 MHz.

Pulse/ramp (20, 80% symmetry): 1.000 mHz to 19.99 MHz.

Haversine/havertriangle: please inquire for special option.

Output Characteristics

Range: amplitude and offset independently variable within ± 10 V window.

Source impedance: selectable 50 $\Omega \pm 1\%$ or 1 k $\Omega \pm 10\%$

Amplitude: 10.0 mVpp to 10.0 Vpp (50 Ω into 50 Ω)
2.00 Vpp to 20.0 Vpp (1 k Ω into 50 Ω)

Accuracy: (sine, square) $\pm 2\%$, $\pm 5\%$ above 5 MHz

Offset: 0 ± 10 mV to ± 5.00 V (50 Ω into 50 Ω)
0 ± 20 mV to ± 10.0 V (1 k Ω into 50 Ω)

Accuracy: $\pm 1\%$ programmed value $\pm 1\%$ signal Vpp ± 20 mV.

Sine Characteristics

Distortion: total harmonic distortion (THD) for fundamental up to 1 MHz: $\pm 1\%$.

Harmonic signals: (fundamental 1-10 MHz): ≤ -36 dB

Harmonic signals: (fundamental above 10 MHz): ≤ -30 dB.

Non-harmonic: ≤ -40 dB.

Square/Pulse Characteristics

Transition times: (10% to 90%): ≤ 5 ns (50 Ω into 50 Ω), ≤ 7 ns (1 k Ω into 50 Ω)

Preshoot/Overshoot/ringing: $\leq \pm 5\%$ (50 Ω into 50 Ω), $\pm 10\%$ (1 k Ω into 50 Ω).

Triangle/Ramp Characteristics

Linearity: (10% to 90%): $\leq \pm 1\%$ ($\leq \pm 5\%$ above 5 MHz).

Operating Modes

Norm (continuous phase locked), **VCO** (external sweep voltage),

Trig (ext or man. one-shot), **Gate**, **Burst** (1-9999 counted cycles),

Frequency Modulation

HP-IB: control and learn capability for all modes and parameters.

General

Memory: non volatile. 10 addressable locations plus one for active operating state. Each location can store a complete set of operating parameters and modes.

Power: 100/120/220/240 Vrms; $\pm 5\%$, -10% ; 48 to 66 Hz, 200 V A max.

Operating temperature: 0° to 50°C

Weight: net 12 kg (26.5 lbs). Shipping 16 kg (35.3 lbs).

Size: 133 H x 426 W x 422 mm D (5.2" x 16.8" x 16.6").

Ordering Information

8165A Programmable Signal Source*

Opt 002: AM and logarithmic sweep

Opt 003: Rear Panel Connectors

Opt 907: Front Handle Kit (Part No 5061-0089)

Opt 908: Rack Mounting Kit (Part No 5061-0077)

Opt 909: Opt 907, 908 combined (Part No 5061-0083)

Opt 910: additional Operating and Service Manual

*HP-IB cables not supplied, see page 37.

FUNCTION GENERATORS & FREQUENCY SYNTHESIZERS

1 μ Hz to 21 MHz Synthesizer/Function Generator

Model 3325A

- Synthesizer
- Function generator
- Sweeper
- Programmable

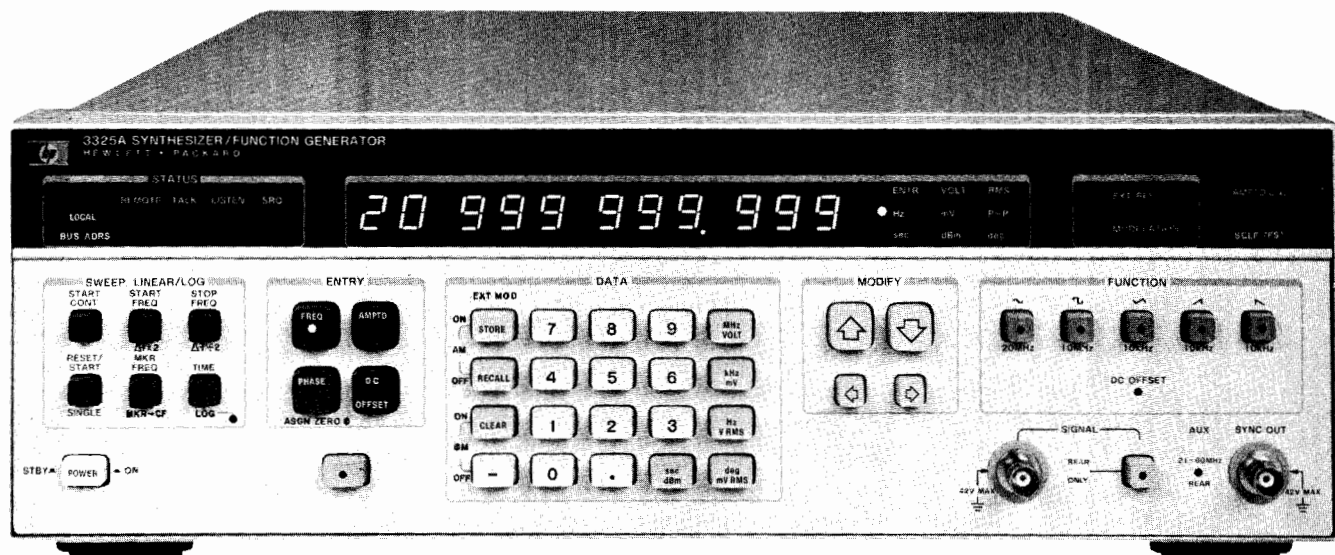

3325A



Description

The 3325A Synthesizer/Function Generator is an uncompromising, high performance synthesizer with 11 digit resolution, a function generator with precision waveforms, a wideband sweeper, and a fully programmable systems instrument.

Synthesizer

The 3325A is first with microhertz resolution below 100 kHz along with frequency coverage from .000001 Hz to 20.999 999 999 MHz. Signal purity, accuracy and stability are as good or better than earlier stand-alone HP synthesizers. Harmonics are 65 dB down below 50 kHz and you can externally modulate with AM and PM.

Function Generator

The 3325A is also a high performance function generator providing precision waveforms with synthesizer accuracy and resolution. Squarewaves to 10.999 999 999 MHz have 20 ns rise and fall times. Triangles and ramps with .05% linearity are available up to 10.999 999 999 kHz. All waveforms can be DC and phase offset.

A Wideband Sweeper

A major contribution is wideband phase continuous sweep, covering up to the full frequency range of each waveform. Sweep log or linear, single or continuous without the phase discontinuities usually associated with synthesizers. Phase lock loop testing is made easier.

Make convenient swept frequency network measurement on filters, amplifiers or any passive or active network. Use the TTL marker to check the frequency of points of interest on a swept frequency display desired. Use the convenient "zoom" functions $\Delta F \times 2$ and $\Delta F \div 2$ to quickly change the frequency span for the display desired.

Fully Programmable

All necessary functions are programmable on the HP-IB, including frequency, amplitude, all functions, phase and DC offset, modulation, all sweep parameters, amplitude cal and self-test, making the 3325A a very versatile and powerful addition to automatic test systems. The isolated interface combined with floating outputs and inputs and talk mode make the 3325A easy to use in Automatic Test Systems.

More Features

The phase of the output can be changed $\pm 719.9^\circ$ with $.1^\circ$ resolution. The phase is advanced (or retarded) with respect to the starting

phase. Two 3325A units can be phase locked together for dual phase output applications.

DC offset is capable of ± 4.5 VDC on the standard instrument. The high voltage option (Opt 002) allows AC voltages up to 40 Vpp and AC + DC up to ± 18 V Total (AC peak + DC).

Ten storage registers can be programmed with ten different combinations of function/parameter settings from the front panel, stored and then recalled.

The 3325A can display 11 digits of frequency and 4 digits of volts or millivolts from 1 mV to 10 volts peak to peak. Conversion to RMS or dBm is simple with the touch of a button.

New Technology

The 3325A provides unprecedented performance per dollar thanks to several major contributions from advances in HP technology. A single loop Fractional-N synthesis technique allows synthesizer accuracy with 11 digits of resolution, and as an added bonus... phase continuous frequency sweep. Fewer parts and integrated circuit technology make the difference. A unique method of triangle and ramp waveform generation provides excellent linearity. Add micro-processor control and Hewlett-Packard Interface Bus (HP-IB) operation and the result is more performance, flexibility and versatility on the bench, or in automatic test systems than previously available, and at a lower cost.

Specifications

Refer to the 3325A Data Sheet for complete specifications.

Waveforms

Sine, Square, Triangle, negative and positive Ramps

Frequency

Range

Sine: 1 μ Hz to 20.999 999 999 MHz

Square: 1 μ Hz to 10.999 999 999 MHz

Triangle/ramps: 1 μ Hz to 10.999 999 999 kHz

Resolution: 1 μ Hz, < 100 kHz

1 mHz \geq 100 kHz

Aging rate: $\pm 5 \times 10^{-6}$ /year, 20° to 30°C

Warm-up time: 20 minutes to within specified accuracy



Main Signal Output (all waveforms)

Impedance: 50 Ω

Connector: BNC; switchable to front or rear panel, nonswitchable with option 002, except by internal cable change.

Amplitude

Range: 1 mV to 10 V p-p in 8 amplitude ranges, 1-3-10 sequence (10 dB steps), into 50 Ω load.

Function	Sine		Square		Triangle/Ramps	
	min	max	min	max	min	max
Units Displayed						
peak-peak	1.000 mV	10.00 V	1.000 mV	10.00 V	1.000 mV	10.00 V
rms	0.354 mV	3.536 V	0.500 mV	5.000 V	0.289 mV	2.887 V
dBm (50 Ω)	-56.02	+23.98	-53.01	+26.99	-57.78	+22.22

Resolution: 0.03% of full range or 0.01 dB (4 digits).

Amplitude Accuracy (without dc offset, relative to programmed amplitude and accuracy)

Sinewave Amplitude Accuracy

1 MHz to 100 kHz: ± 0.1 dB, ≥ 3 Vpp; ± 2 dB, < 3 Vpp

100 kHz to 20 MHz: ± 0.4 dB, ≥ 3 Vpp; ± 0.6 dB, $.1$ to 3 Vpp

Squarewave Amplitude Accuracy

1 MHz to 100 kHz: 1%, ≥ 3 Vpp; 2.2%, < 3 Vpp

100 kHz to 10 MHz: 11.1%, ≥ 3 Vpp; 13.6%, < 3 Vpp

Triangle Amplitude Accuracy

1 MHz to 2 kHz: 1.5%, ≥ 3 Vpp; 2.7%, < 3 Vpp

2 kHz to 10 kHz: 5%, ≥ 3 Vpp; 6.2%, < 3 Vpp

Sinewave Spectral Purity

Phase noise: -60 dB for a 30 kHz band centered on a 20 MHz carrier (excluding ± 1 Hz about the carrier) with high-stability option 001 installed.

Spurious: all non-harmonically related output signals will be more than 70 dB below the carrier (60 dB with dc offset), or less than -90 dBm, whichever is greater.

Sinewave harmonic distortion: harmonically related signals will be less than the following levels (relative to the fundamental) at full output for each range:

Frequency Range	Harmonic Level
0.1 Hz to 50 kHz	-65 dB
50 kHz to 200 kHz	-60 dB
200 kHz to 2 MHz	-40 dB
2 MHz to 15 MHz	-30 dB
15 MHz to 20 MHz	-25 dB

Squarewave Characteristics

Rise/fall time: ≤ 20 ns, 10% to 90% at full output

Overshoot: $\leq 5\%$ of peak to peak amplitude, at full output

Settling time: < 1 μ s to settle to within .05% of final value.

Phase Offset

Range: $\pm 719.9^\circ$ with respect to arbitrary starting phase or assigned zero phase

Resolution: 0.1°

Accuracy: $\pm 0.2^\circ$

DC Offset

Range: dc only (no ac signal): 0 to ± 5.0 V/50 Ω .

dc + ac: Maximum dc offset ± 4.5 V on highest range, decreasing to ± 4.5 mV on lowest range.

Resolution: 4 digits

Sinewave Amplitude Modulation

Modulation depth at full output for each range: 0-100%

Modulation frequency range: dc to 400 kHz (0-21 MHz carrier frequency)

Sensitivity: ± 5 V peak for 100% modulation

Sinewave Phase Modulation

Range: $\pm 850^\circ$, ± 5 V input

Modulation frequency range: dc -5 kHz

Frequency Sweep

Sweep Time

Linear: 0.01 s to 99.99 s

Logarithmic: 2 s to 99.99 s single, 0.1 s to 99.99 s continuous

Maximum sweep width: full frequency range of the main signal output for the waveform in use, except minimum log start frequency is 1 Hz.

Phase continuity: sweep is phase continuous over the full frequency range of the main output.

Auxiliary Inputs and Outputs

Reference input: for phase-locking 3325A to an external frequency reference signal from 0 dBm to +20 dBm into 50 Ω . Reference signal must be a subharmonic of 10 MHz from 1 MHz to 10 MHz.

Auxiliary frequency output: 21 MHz to 60.999 999 999 MHz, under range coverage to 19.000 000 001 MHz, frequency selection from front panel. 0 dBm; output impedance: 50 Ω

Sync output: square wave with V (high) ≥ 1.2 V, V (low) ≤ 0.2 V into 50 Ω .

X-Axis drive: 0 to $> +10$ V dc linear ramp proportional to sweep frequency, linearity, 10-90%, $\pm .1\%$ of final value.

Sweep marker output: high to low TTL compatible voltage transition at selected marker frequency.

Z-Axis blank output: TTL compatible voltage levels capable of sinking 200 mA from a positive source.

1 MHz reference output: 0 dBm output for phase-locking additional instruments to the 3325A.

10 MHz oven output: 0 dBm internal high stability frequency reference output for phase-locking 3325A. (Opt. 001 only)

Option 001 High Stability Frequency Reference

Aging rate: $\pm 5 \times 10^{-8}$ /week (72-hr. warm up); $\pm 1 \times 10^{-7}$ /month (after 15 days continuous operation).

Ambient stability: $\pm 5 \times 10^{-8}$ (0° to $+55^\circ\text{C}$).

Warm-up time: reference will be within $\pm 1 \times 10^{-7}$ of final value 15 minutes after turn-on for an off time of less than 24 hours.

Option 002 High Voltage Output

Frequency range: 1 μ Hz to 1 MHz

Amplitude

Range: 4.00 mVpp to 40.00 Vpp (500 Ω , < 500 pf load).

Accuracy and Flatness at Full Output

Sine, square, and triangle waves: $\pm 2\%$ at 2 kHz

Ramps: $\pm 2\%$ at 500 Hz

Flatness: $\pm 10\%$ relative to programmed amplitude

Sinewave distortion: harmonically related signals will be the same as the standard instrument to 1 MHz

Maximum output current: 80 mA_{app}.

Output impedance: < 2 Ω at dc, < 10 Ω at 1 MHz

DC offset range: 4 times the specified range of the standard instrument.

General

Operating environment:

Temperature: 0°C to 55°C .

Relative humidity: 95%, 0°C to 40°C .

Altitude: $\leq 15,000$ ft.

Storage temperature: -40°C to $+75^\circ\text{C}$.

Storage altitude: $\leq 50,000$ ft.

Power: 100/120/220/240 V, +5%, -10%, 48 to 66 Hz; 90 VA, 120 VA with all options; 10 VA standby.

Weight: 9 kg (20 lbs.) net; 14.5 kg (32 lbs.) shipping.

Size: 132.6 H x 425.5 W x 497.8 mm D (5.25" x 16.75" x 19.63").

Accessories: 11356A Ground Isolator for breaking signal grounds between input/output connectors.

Ordering Information*

3325A Frequency Synthesizer

Opt. 001 High Stability Frequency Reference

Opt. 002 High Voltage Output

Opt 907 Front Handle Kit (stand alone orders P/N 5061-0089)

Opt 908 Rack Flange Kit (stand alone orders P/N 5061-0077)

Opt 909 Rack Flange and Handle Combination Kit (stand alone orders P/N 5061-0083)

11356A Ground Isolator

*HP-IB cable not supplied. See page 37.

FUNCTION GENERATORS & FREQUENCY SYNTHESIZERS

Synthesizer/Level Generator 200 Hz to 81 MHz
Model 3335A

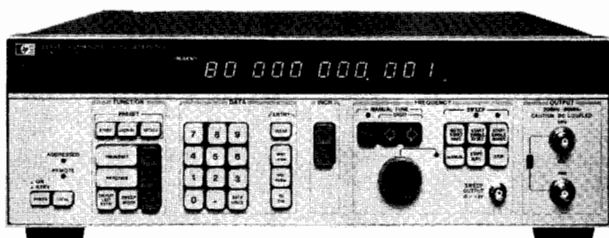

3335A



- 1 MHz resolution
- High spectral purity
- Precision amplitude control
- Program storage
- HP-IB

Description

Covering a frequency range of 200 Hz–81 MHz, the 3335A Synthesizer/Level Generator has performance characteristics that make it ideally suited for the telecommunications industry, as well as for traditional synthesizer applications, including testing of Frequency Division Multiplex (FDM) equipment and R & D and production testing of communications systems. It features precision level control, millihertz resolution, high spectral purity, internal frequency sweep, HP-IB programmability and numerous user conveniences.

Internal Storage

Up to 10 different front panel settings (frequency, level, θ incr, etc.) can be stored in internal memory registers for later recall. The DISPLAY key allows viewing of register contents without altering the synthesizer output.

Precision Amplitude

Increasing channel capacity of Frequency Division Multiplex (FDM) systems is continually placing more stringent requirements on the testing of transmission parameters. To meet these performance standards, the 3335A incorporates a state-of-the-art attenuator resulting in attenuator accuracies of up to $\pm .025$ dB over the 81 MHz frequency range.

Programmability

The 3335A is fully programmable via the Hewlett-Packard Interface Bus (HP-IB), HP's implementation of IEEE Standard 488–1975. Most Hewlett-Packard 9800 Series Programmable Calculators, as well as Models 21 MX and 2100 series minicomputers, are easily interfaced to the HP-IB.

Frequency Stability

The 3335A synthesizes its output frequency from an internal temperature-controlled crystal oscillator which provides $\pm 1 \times 10^{-8}$ /day frequency stability ($\pm 5 \times 10^{-10}$ is optional). The 3335A can also be phase-locked to any external frequency standards.

Automatic Frequency Sweep

The 3335A combines the precision frequency accuracy and stability of a synthesizer with the time-saving convenience of a digital sweeper.

SLMS - Tracking Generator

The 3335A operates as a tracking generator with the HP 3745A/B Selective Level Measuring Set (SLMS), or the 3586A/B/C Selective Level Meter for automatic or semi-automatic testing of FDM systems. For closed-loop tracking where the 3335A and 3745A/B are in the same location, the frequency of the generator is controlled by the microprocessor in the SLMS.

Options

Standard: equipped with switch-selectable 50 Ω and 75 Ω outputs (BNC connectors).

001: High-stability frequency reference

002/004: Equipped with 75 Ω unbalanced and 124 Ω and 135 Ω balanced connectors per table.

Option	Fits WECO Type	Spacing	Accepts WECO Type
75 Ω	002 004	477B 560A	N/A 358A 439A/440A
124 Ω	002 004	477B 560A	16 mm (.625") 12.7 mm (0.5") 372A 443A
135 Ω	002/004	223A	16 mm (.625") 241A

003: 75 Ω unbalanced BNC output and 150 Ω balanced output using a pair of BNC connectors at 20 mm (0.80 in.) spacings.

Abbreviated Specifications

(For complete specifications, refer to page 384 and the 3335A data sheet.)

Frequency Range

Standard: 200 Hz–81 MHz;

Opt. 002/004: 75 Ω , 200 Hz–81 MHz; 124 Ω , 10 kHz–10 MHz; 135/150 Ω , 10 kHz - 2 MHz.

Opt. 003: 75 Ω , 200 Hz–81 MHz; 150 Ω , 10 kHz - 2 MHz

Frequency resolution: .001 Hz.

Stability, long term: $\pm 1 \times 10^{-8}$ /day; $\pm 1 \times 10^{-7}$ /month.

Opt. 001 (high stability frequency reference)

Aging rate: $\pm 5 \times 10^{-10}$ /day; $\pm 2 \times 10^{-8}$ /month; $\pm 1 \times 10^{-7}$ /year

Warmup: Within 5×10^{-9} of final value 20 minutes after turn-on at 25°C.

Spectral Purity

Harmonic distortion: 200 Hz–10 MHz: < -45 dBc; 10 MHz–81 MHz: < -40 dBc

Phase noise (30 kHz band, excluding ± 1 Hz, centered on the carrier): 9.9 MHz: < -63 dBc; 20 MHz: < -70 dBc; 40 MHz: < -64 dBc; 81 MHz: < -58 dBc

Spurious: nonharmonically related signals: the greater of -75 dBc or -125 dBm (50/75 Ω), -97 dBm (124 Ω), -68 dBm (135/150 Ω)

Amplitude Range

Standard: +13.01 dBm to -86.98 dBm; 75 Ω : +11.25 dBm to -88.74 dBm.

Opt. 002/004: 75/124/135 Ω : +11.25 dBm to -88.74 dBm

Opt. 003: 75/150 Ω : +11.25 dBm to -88.74 dBm

Signal balance (124 Ω , 135 Ω , 150 Ω balanced outputs): > 60 dB at 100 kHz

Resolution: 0.01 dB

Absolute level accuracy (max. output at 100 kHz, 20°C to 30°C): 50/75 Ω ± 0.05 dB; 124/135/150 Ω : ± 0.1 dB

Flatness (relative to 100 kHz, full amplitude): 50/75 Ω : 1 kHz–25 MHz: ± 0.07 dB; 200 Hz - 81 MHz: ± 0.15 dB. 124 Ω : 10 kHz - 10 MHz: ± 0.15 dB, 10 kHz - 10 MHz ± 0.4 dB; 135/150 Ω : 10 kHz - 2 MHz: ± 0.18 dB

Attenuator Accuracy (relative to 100 kHz, full amplitude)

Impedance	Amplitude (dBm)	Frequency		
		200 Hz	25 MHz	80 MHz
50 Ω	+13.01 to -6.98	± 0.03 dB		
	-6.99 to -46.98	± 0.07 dB		
	-46.99 to -86.98	± 0.20 dB		
75 Ω	+11.25 to -8.74	± 0.04 dB	± 0.15 dB	
	-8.75 to -48.74	± 0.09 dB	± 0.25 dB	
	-48.75 to -88.74	± 0.20 dB	± 0.50 dB	

NOTE: For 124 Ω , 135 Ω , and 150 Ω , refer to data sheet.

Options

001: Hi-stability reference $\pm 5 \times 10^{-10}$ /day

002: Connector option (75/124/135 Ω)

003: Connector option (75/150 Ω)

004: Connector option (75 Ω , miniature WECO on 124/135 Ω)

3335A Synthesizer/Level Generator

FUNCTION GENERATORS & FREQUENCY SYNTHESIZERS

Synthesizer / Level Generator

Model 3336C

337

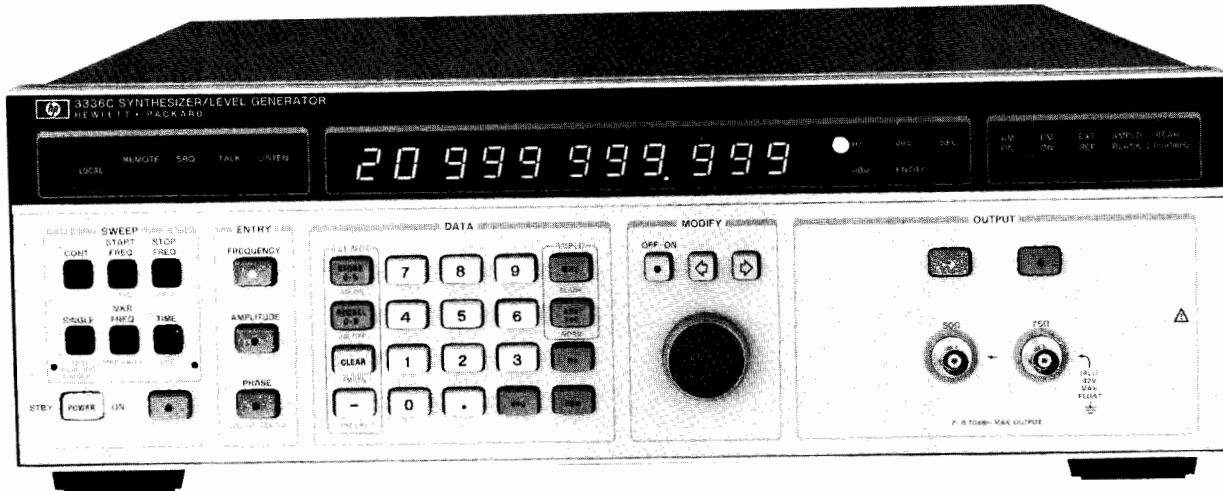

3336C



Description

Covering a frequency range of 10 Hz to 20.999 MHz, the 3336C is designed for traditional synthesizer applications as well as R&D and production testing of systems or components. It features precision level control, high spectral purity, optional frequency stability of $\pm 5 \times 10^{-8}$ /week, internal frequency sweep and numerous user conveniences. All models include HP-IB (IEEE Std. 488-1975) as a standard feature for use in automatic test systems.

Precision Frequency Measurements

Major advances in HP technology have provided a single loop, fractional-N synthesis technique which allows synthesizer accuracy with 11 digits of resolution, with completely phase continuous frequency sweep over any of the instrument's frequency ranges. Microhertz resolution below 100 kHz allows precise frequency measurements over a range of 10 Hz to 20.999 999 999 MHz. Harmonics are below -60 dBc over the range from 50 Hz to 1 MHz (-50 dBc to 20 MHz), with spurious signals below -70 dBc or -100 dBm in the standard instrument, -115 dBm with an option. Integrated Phase Noise is -64 dBc (30 KHz bw).

± 0.05 dB Amplitude Accuracy

New HP attenuator technology coupled with custom designs in leveling loops and thermal converters produce amplitude accuracies seen only in instruments at much greater cost. The fast leveling loop makes extremely flat sweeps possible at fast sweep speeds. External leveling is also available for those custom applications where a control loop is desired.

Other Features

Models 3336 A & B are also available for the telecommunications industry. See page 564. All three models (the 3336A, B & C) have 10 storage registers; amplitude blanking capability during frequency switching; linear or logarithmic phase continuous sweep capabilities; RPG (rotary pulse generator) to simplify modification of any digit in the display; phase offset capability; output connector and impedance flexibility; AM and PM modulation, and many other features. Refer to the data sheet for complete information.

Abbreviated Specifications

Frequency

Range: 10 Hz to 20.999 999 999 MHz

Resolution: 1 μ Hz for frequencies < 100 kHz, 1 mHz for frequencies \geq 100 kHz

Aging rate: $\pm 5 \times 10^{-8}$ /year (20° to 30°C)

Warm-up time: 30 minutes to within specified accuracy

Amplitude

Range: 50 Ω : -71.23 to +8.76 dBm; 75 Ω : -72.99 to 7.00 dBm

Absolute accuracy: $\pm .05$ dB, 20° to 30°C (for the top 9.99 dB of amplitude range at 10 kHz), $\pm .08$ dB, 0° to 55°C

Flatness: 50/75 Ω , $\pm .1$ dB ($\pm .07$ dB with option 005) referenced to 10 kHz.

Attenuator Accuracy: (instruments without option 005)

	10 Hz	1 MHz	10 MHz	20.9 MHz
10 to 19.99 dB	$\pm .1$ dB	$\pm .15$	$\pm .2$ dB	$\pm .2$ dB
20 to 39.99 dB	$\pm .15$ dB	$\pm .2$ dB	$\pm .25$ dB	$\pm .25$ dB
40 to 79.99 dB	$\pm .2$ dB	$\pm .25$ dB	$\pm .3$ dB	$\pm .3$ dB

Note: Amplitude Accuracy is the sum of the Absolute Accuracy and, as necessary, Flatness and Attenuator Accuracy.

Phase Offset

Range: $\pm 719.9^\circ$ with respect to arbitrary reference phase.

Amplitude Modulation

Modulation depth: 0 to 100%

Modulation frequency range: 50 Hz to 50 kHz

Envelope distortion: < -30 dB to 80% modulation (1 kHz modulating freq.)

Phase Modulation

Range: 0° to $\pm 850^\circ$

Linearity: $\pm 0.5\%$ from best fit straight line

Modulation frequency range: dc to 5 kHz

Input sensitivity: ± 5 V peak for 850° phase shift (170°/volt)

Frequency Sweep

Sweep time: Linear; 0.01 s to 99.99 s. Single Log; 2 s to 99.99 s. Continuous Log; 0.1 s to 99.99 s.

Maximum sweep width: specified frequency range of selected output

Minimum sweep width: Log; 1 decade. Linear; minimum BW (Hz) = .1 (Hz/s) x Sweep Time (s)

Phase continuity: phase is continuous over full frequency range.

Sweep flatness: fast leveling; $\pm .15$ dB, 10 kHz to 20 MHz, .03 s

Sweep time: normal leveling; $\pm .15$ dB, 50 Hz to 1 MHz, .5s sweep time.

General

Operating Environment

Temperature: 0° to 55°C

Relative humidity: $\leq 85\%$, 0° to 40°C

Altitude: $\leq 15,000$ ft, (4600 meters)

Storage temperatures: -50° to +65°C

Storage altitude: $\leq 50,000$ ft, (15,240 meters)

Power requirements: 100/120/220/240 V, +5%, -10%, 48 to 66 Hz, 60 VA, (100 VA with all options), 10 VA standby

Size: 132.6 mm H x 425.5 mm W x 497.8 mm D, (5.2" x 16.8" x 19.6")

Weight: net, 10 kg. (22 lbs.). Shipping, 15.5 kg. (34 lbs.)

Ordering Information

3336C Synthesizer/Level Generator (General Purpose)

Opt 004 High Stability Frequency Reference

Opt 005 High Accuracy Attenuator

Opt 907 Front Handle Kit

Opt 908 Rack Flange Kit

Opt 909 Rack Flange and Handle Kit

SIGNAL GENERATORS

Signal Generators to 40 GHz

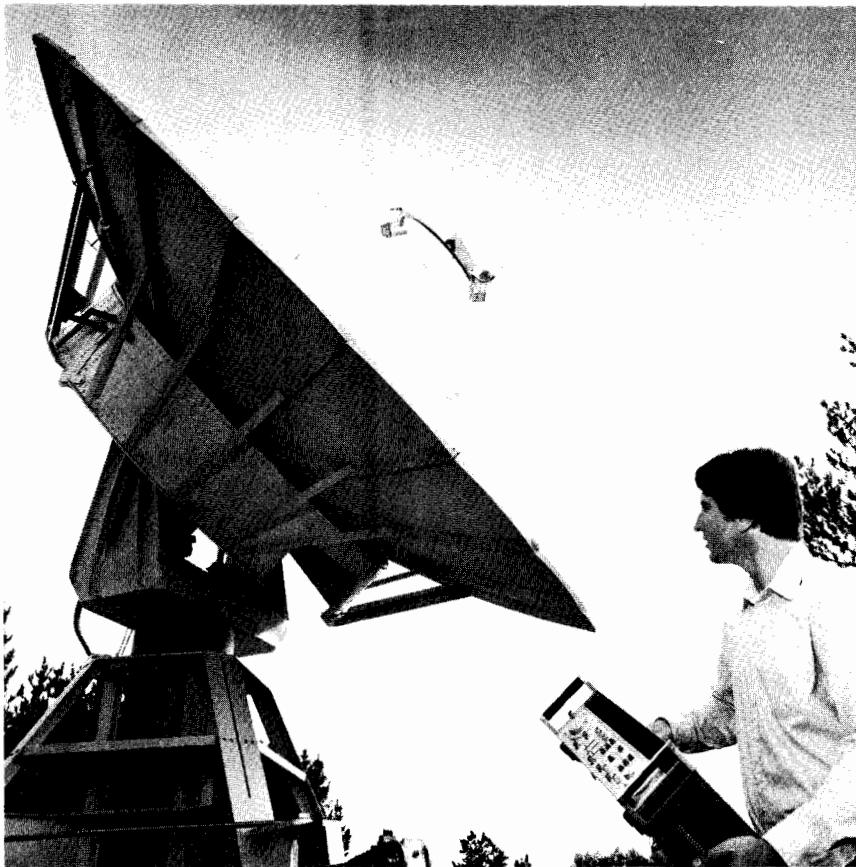

Hewlett-Packard offers a complete line of signal generators from 10 kHz to 40 GHz. This line includes synthesized and solid-state mechanically tuned generators as well as performance-proven vacuum tube signal generators. Each includes the following: 1) accurately calibrated variable frequency, 2) accurately calibrated variable output level, and 3) wide modulation capability.

HP signal generators provide the performance necessary for a wide variety of measurements, including receiver tests such as sensitivity and selectivity. Versatile modulation makes them ideal for signal simulation applications such as signal-to-noise ratio and antenna gain. They also provide power to drive mixers, bridges, and slotted lines.

Synthesized Signal Generators

Collectively covering a frequency range from 10 kHz to 26.5 GHz, these versatile programmable signal generators are used in a wide variety of automated systems and high performance applications.

10 kHz to 2560 MHz Low Noise Synthesized Signal Generators

The 8662A covers 10 kHz to 1280 MHz with calibrated output from +13 to -140 dBm. The 8663A shares the frequency synthesis circuitry of the 8662A, and covers 100 kHz to 2560 MHz with calibrated levels from +16 to -130 dBm. Both generators feature extremely low phase noise and spur-

ious while maintaining fast frequency switching. The low phase noise close to the carrier (-112 dBc/Hz at a 100 Hz offset) optimizes the 8662A and 8663A for critical low noise applications like local oscillator substitution and multiplication to microwave frequencies. In addition, the low noise at typical channel spacings (-132 dBc/Hz at 10 kHz offset) allows both in-channel and out-of-channel measurements to be made under programmable control. The 8662A has AM and FM. The 8663A offers AM, FM, Φ M, and pulse modulation and a 10 Hz to 99.9 kHz modulation oscillator. Both the 8662A and the 8663A feature precision digital sweep and full HP-IB programmability.

0.1 to 990 MHz Low Cost Synthesized Signal Generator

The 8656A, an economical programmable RF signal generator, provides synthesized signals from 0.1 to 990 MHz. The 8656A offers a wide range of standard features, including 100 and 250 Hz resolution, full keyboard control, reverse power protection to 50 W, and HP-IB programmability.

Featuring AM, FM and simultaneous modulation with external modulating signals or internal 400 Hz and 1 kHz tones, the 8656A is ideal for in-channel receiver testing. Receiver channels are easily selected with the frequency increment feature. Because HP-IB is standard, the 8656A is a cost-effective solution for in-channel measurements and an ideal general-purpose RF

source for other automatic system applications.

The 8656A also features excellent output level accuracy of ± 1.5 dB and precise output level resolution of 0.1 dB for increased measurement accuracy and settability. Testing of RFI-susceptible devices is made possible by the low RFI leakage of the 8656A.

10 kHz to 2600 MHz Synthesized Signal Generator

The HP 8660A/C is a particularly versatile synthesized signal generator family, offering two mainframes and a variety of RF and modulation plug-ins. The 8660A mainframe utilizes thumbwheel switches for frequency selection. The 8660C has a more versatile keyboard control featuring synthesized digital sweep and frequency-step capability. Both HP-IB and BCD programming interfaces are available.

Three plug-in RF sections provide separate frequency ranges: 10 kHz to 110 MHz, 1 MHz to 1300 MHz, and 1 MHz to 2600 MHz. Output levels are calibrated over >140 dB range. Five different modulation plug-ins provide versatile combinations of AM, FM, Φ M, and pulse modulation.

0.01 to 26.5 GHz Microwave Synthesized Signal Generators

The 8670 series of microwave synthesizers and the 8340A synthesized sweeper cover four frequency ranges for measurement flexibility and broadband frequency coverage. They also feature good spectral purity and stability, versatile modulation, and full HP-IB programmability for signal simulation applications.

The 8671A is a synthesizer only, covering 2 to 6.2 GHz with a minimum output of +8dBm and external FM capability. The 8672A is a 2 to 18 GHz AM/FM generator with calibrated output from +3 to -120 dBm (+8 dBm with Option 008). The 8672S provides all the capability of the 8672A, plus extended frequency coverage from 0.01 to 18 GHz and internal high-quality pulse modulation over the entire frequency range.

The 8673B spans 2 to 26.5 GHz, with +8 to -100 dBm output level. Internal pulse modulation as well as external metered AM and FM allow complex signal simulation. The 8673B, with proven performance and reliability, also features 1 to 4 kHz frequency resolution and stable digital sweep.

The 8673D has all the performance of the 8673B, with extended frequency coverage from 0.05 to 26.5 GHz, and harmonically related spurious outputs < -60 dBc from 2 to 26.5 GHz. Output power is $> +5$ dBm across the operating band. The 8673C offers all the above performance from 50 MHz to 18.6 GHz.

The 8340A covers 10 MHz to 26.5 GHz and offers the same excellent CW performance as the 8670 series. It is also a high-performance sweep oscillator, providing wide and narrow band continuous analog sweeps. Other features include 1 to 4 Hz frequency resolution, high-quality internal pulse and amplitude modulation, and calibrated output power from +12 to -110 dBm.



Solid-State, Mechanically Tuned Generators

Solid-state mechanically tuned generators combine fundamental oscillators with solid-state circuitry to yield excellent spectral purity for modern performance requirements.

2.3 to 12.5 GHz Solid-State Generators

The 8680 series solid-state signal generators are designed to meet the stringent requirements of modern microwave radar and communications testing. With the 8683 covering from 2.3 to 6.5 GHz, and 8684 spanning 5.4 to 12.5 GHz, these generators feature cavity-tuned oscillators to provide excellent frequency stability, spectral purity, and reliability.

Both the 8683 and the 8684 are available in the "A" version, optimized for communications testing, and the "B" version for radar applications. The B models feature +10 dBm standard output power, and an internal pulse modulator and pulse generator yielding > 80 dB on/off ratio, and rise/fall times < 10 ns.

The A models offer the same outstanding performance as the B models, but with only limited external pulse modulation. Both models have low distortion AM and FM, an internal variable sawtooth for FM swept measurements, and provide outstanding ± 2.5 dB level accuracy and 1% frequency accuracy.

0.5 to 1024 MHz, High Performance

The performance leaders of the RF mechanically tuned family are the 8640A and 8640B signal generators, covering 450 kHz to 550 MHz. Frequency coverage can be extended to 1024 MHz with an internal doubler (Option 002), and an optional built-in audio oscillator extends the CW range down to 20 Hz (Option 001). The 8640 provides wide output level range from +19 to -145 dBm. High performance AM and FM and low phase noise at typical receiver channel spacings makes the 8640 an ideal generator for a wide variety of receiver measurements.

The 8640B with built-in counter has the ability to count external signals at frequencies up to 550 MHz and to phase-lock the generator's RF output to the counter time base for frequency stability of better than 5×10^{-8} /hour. The 8640A utilizes a mechanical slide rule frequency dial.

For avionics navigation and communications applications, the 8640B Option 004 can be combined with suitable external modulation sources for testing ILS, VOR, and VHF communications receivers.

10 to 520 MHz, Compact, Field Portable, Economy

Compact, portable signal generators form another part of the solid-state, mechanically tuned family. The 8654A and 8654B cover from 10 to 520 MHz, providing output power from +10 to -130 dBm. Small size and light

weight make them well suited for field maintenance and operational readiness checks in addition to general purpose signal generator applications. The 8654B has fully calibrated and metered AM and FM, whereas the 8654A is an AM generator with uncalibrated FM capability.

Performance-Proven Vacuum Tube Signal Generators

The 8614A and 8616A are vacuum tube signal generators, covering 0.8 to 2.4 GHz and 1.8 to 4.5 GHz. They feature built-in PIN diode modulators, allowing internal or external output power leveling as well as high performance pulse and amplitude modulation.

HP 938A and 940A Frequency Doubler Sets provide low-cost 18 to 40 GHz signals by doubling the frequency of signal sources in the 9 to 20 GHz range.

Signal Generator Accessories

A variety of accessories enhance the operation of HP signal generators. These include frequency doublers, balanced mixers, and a series of PIN modulators. The 11720A pulse modulator provides high performance pulse modulation capability from 2 to 18 GHz. The 11710B Down Converter extends the frequency range of the 8640 and 8654 down to 10 kHz. The 11729B Carrier Noise Test Set can be used with a signal generator to provide a critical piece of a sensitive, automatable noise measurement system.

Signal Generator Summary

Frequency Range	Model	Characteristics	Page
10 to 520 MHz	8654A, 8654B Signal Generators	Calibrated and leveled output from +10 to -130 dBm. Amplitude and frequency modulation. Compact, portable (17.5 lb).	352
0.5 to 1024 MHz	8640A, 8640B, 8640B Opt. 004 Signal Generators	Calibrated and leveled output from +19 to -145 dBm. AM, FM, and ext. pulse modulation. 8640B has built-in counter and phase lock capability. Avionics option available (Opt. 004).	348
0.1 to 990 MHz	8656A Synthesized Signal Generator	± 1.5 dB absolute level accuracy from +13 dBm to -127 dBm in 0.1 dB steps. Calibrated AM and FM. Frequency resolution of 100 Hz or 250 Hz. Time base aging rate of ± 2 ppm/year.	340
0.01 to 1280 MHz	8662A Synthesized Signal Generator	Low noise. 0.1 Hz frequency resolution, 5×10^{-9} /day stability. Calibrated and leveled output from +13 to -140 dBm. Digital sweep. Completely HP-IB programmable. AM/FM modulation.	342
0.1 to 2560 MHz	8663A Synthesized Signal Generator	Low noise. 0.1 Hz frequency resolution, 5×10^{-10} /day stability. Calibrated and leveled output from +16 to -130 dBm. Digital sweep. Completely HP-IB programmable. AM, FM/ Φ M, pulse modulation.	344
0.01 to 110 MHz 1 to 1300 MHz 1 to 2600 MHz	8660A, 8660C Synthesized Signal Generators	1 Hz frequency resolution, 3×10^{-9} /day stability. Calibrated and leveled output from +13 to -146 dBm. HP-IB and BCD programmable. AM, FM, Φ M, pulse modulation. Plug-ins determine frequency range and modulation capability.	345
0.8 to 2.4 GHz 1.8 to 4.5 GHz	8614A, 8616A Signal Generators	Output +10 (8616; +3 dBm above 3 GHz) to -127 dBm into 50 ohms, leveled below 0 dBm. Internal square-wave; external pulse, AM and FM. Auxiliary RF output.	353
2.3 to 6.5 GHz 5.4 to 12.5 GHz	8683/84 A,B Signal Generators	High spectral purity, stability. ± 2.5 dB absolute level accuracy from +10 to -110 dBm (0 dBm, A models). AM, FM standard. High perf. internal pulse modulator and pulse generator with B models. Portable, rugged (19.1 kg).	354
2.3 to 13 GHz 5.4 to 18 GHz	8683/84 D Signal Generators	Same as B model except with wideband frequency coverage. DC coupled FM with ± 10 MHz deviations available. -3dBm standard output power in doubled frequency band. +10 dBm available with option 001.	354
2 to 6.2 GHz	8671A Synthesizer	1 kHz frequency resolution, 5×10^{-9} /day stability, +8 dBm minimum output. Completely HP-IB programmable. Ext. FM.	359
2 to 18 GHz	8672A Synthesized Signal Generator	1 to 3 frequency resolution, 5×10^{-9} /day stability. Calibrated and leveled output from +3 to -120 dBm. Completely HP-IB programmable. Metered external AM and FM.	356
0.01 to 18 GHz	8672S Synthesized Signal Generator	1 to 3 kHz frequency resolution, 5×10^{-9} /day stability. Internal pulse modulator. Calibrated and leveled output from +2 to -120 dBm. Metered external AM and FM. Completely HP-IB programmable.	359
0.05 to 18.6 GHz	8673C Synthesized Signal Generator	Harmonics and sub-harmonics < -60 dBc. 1 to 3 kHz resolution. +2 to -100 dBm output. Pulse, amplitude and frequency modulation. Digital sweep. Completely HP-IB programmable.	358
2 to 26.5 GHz	8673B Synthesized Signal Generator	1 to 4 kHz frequency resolution, 5×10^{-9} /day stability. +8 to -100 dBm output. Pulse, amplitude, and frequency modulation. Digital sweep. Completely HP-IB programmable.	356
0.05 to 26.5 GHz	8673D Synthesized Signal Generator	Harmonics and sub-harmonics < -60 dBc. 1 to 4 kHz resolution. +5 to -100 dBm output. Pulse, amplitude and frequency modulation. Digital sweep. Completely HP-IB programmable.	358
0.01 to 26.5 GHz	8340A Synthesized Sweeper	1 to 4 Hz frequency resolution, 1×10^{-9} /day stability. +12 to -110 dBm output. Pulse and amplitude modulation. Continuous analog sweep with spans from 100Hz to 26.49 GHz. Completely HP-IB programmable.	360
18 to 26.5 GHz 26.5 to 40 GHz	938A, 940A Frequency Doublers	Driven by 9 to 13.25 GHz, 13.25 to 20 GHz sources (HP 8690, 8672A, 8672S, 8673B, 8673D, 8340A, 8350A, and 8620 series). 100 dB precision attenuator.	362

SIGNAL GENERATORS

Synthesized Signal Generator

Model 8656A

- 100 kHz to 990 MHz
- ± 1.5 dB absolute output level accuracy
- 0.1 dB output level resolution
- Versatile modulation
- Increments and store/recall/sequence
- Fully HP-IB programmable

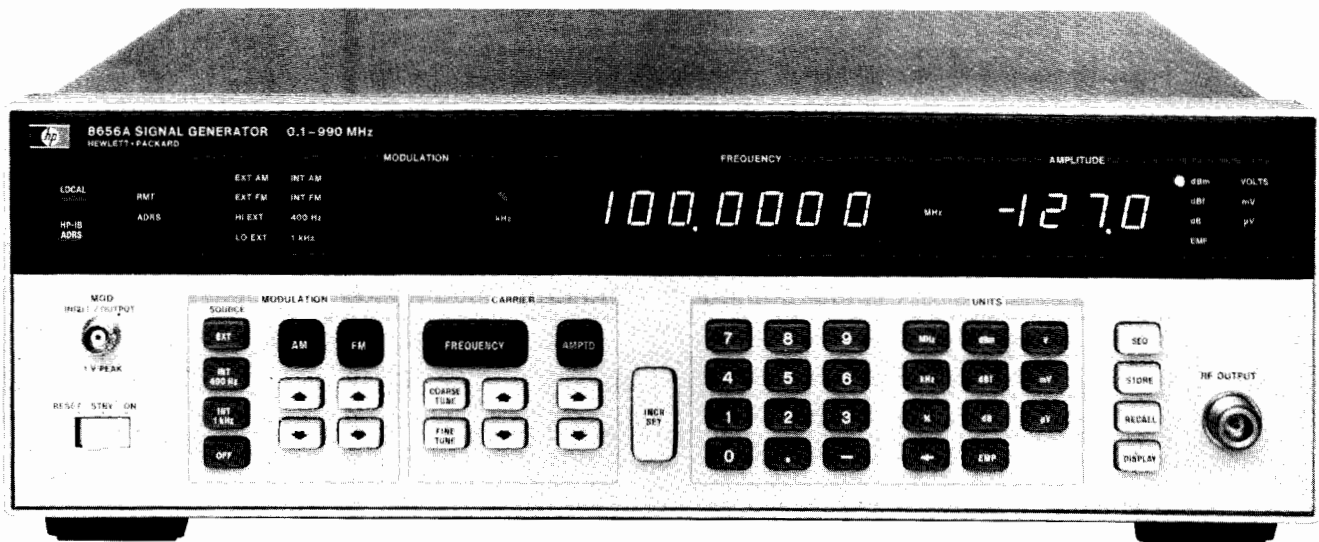

8656A



Description

The 8656A is a programmable synthesized signal generator that offers exceptional value through versatility, ease of operation, and a broad range of standard features.

Frequency

The 8656A provides frequency coverage from 0.1 to 990 MHz (with underrange to 10 kHz). This wide range covers the IF and LO frequencies as well as the RF frequencies of most receivers. It also allows testing in a variety of communication systems including the 800 MHz FM mobile band and some telemetry bands. Frequency resolution of 100 Hz or 250 Hz allows convenient setting of increments including 6.25 kHz channel spacings. Frequency accuracy and stability are determined by the reference used. The standard internal reference has an aging rate of 2 ppm/year. Improved stability and accuracy can be achieved by adding the optional 1×10^{-9} /day high stability time base (Option 001) or using an external reference of 1, 5, or 10 MHz.

Output

The 8656A features ± 1.5 dB absolute accuracy and 0.1 dB resolution for more accurate receiver sensitivity tests, circuit characterization, and R&D applications. The output levels are calibrated from +13 to -127 dBm and may be set and displayed in convenient units including dBm, volts, dB μ V, or EMF. Shielding keeps leakage at $< 1 \mu$ V for testing RFI susceptible devices, and standard resettable reverse power protection for up to 50 watts guards against accidental damage from transmitters.

Modulation

The 8656A has versatile modulation capabilities: internal 400 Hz and 1 kHz tones, simultaneous and mixed modulation modes (AM-AM, FM-FM, AM-FM) from internal and external sources, and the ability to accept low frequency digital unspread signals. For calibrated external modulation, a 1V peak signal is required. HI/LO annunciators on the 8656A indicate when the external signal is within 5% of the correct amplitude.

Ease of Operation

A microprocessor-based controller provides a broad range of operating features for simple but efficient control. Keyboard data entry uses a function/data/units format, and all function entries are made using a left-to-right keystroke sequence. All information entered is visible via LED displays and annunciators. Modulation, frequency, and level functions can be individually incremented by step sizes that are set by convenient keyboard entries. In addition, resolution control keys allow coarse and fine tuning of output frequency in decade steps.

Up to ten front-panel setups can be stored and recalled. A sequence function allows you to cycle through stored setups at the touch of a key or via remote control.

HP-IB Programmability

Full HP-IB programmability is standard in the 8656A. Each programming command has an easy-to-remember, two-character, alphanumeric HP-IB code, and all functions are quickly programmed using the same format as in the manual mode.



8656A Specifications

Frequency

Range: 100 kHz to 990 MHz (8 digit LED display).

Resolution: 100 and 250 Hz.

Accuracy and stability: same as internal time base.

Time Base Characteristics

Typical Characteristics	Standard Time Base	Option 001 Time Base
Aging Rate	±2 ppm/year	1 x 10 ⁻⁹ /day
Frequency	50 MHz	10 MHz
External Reference Input (rear panel)	Accepts any 10, 5 or 1 MHz (±0.002%) frequency standard at a level >0.15 Vrms into 50 ohms.	
Frequency Underrange	10 kHz with uncalibrated output	

Typical frequency switching speed (to be within 100 Hz of final frequency): <2 seconds.

Spectral Purity

Spurious Signals (≤ +7 dBm output levels)

Harmonics: <-25 dBc.

Non-harmonic spurious (greater than 5 kHz from carrier in CW mode): <-60 dBc.

Sub-harmonic spurious: none.

Residual FM

Post Detection Noise Bandwidth	Frequency Range (MHz)			
	0.1 to 123.5	123.5 to 247	247 to 494	494 to 990
0.3 to 3 kHz	<15 Hz rms	<3 Hz rms	<6 Hz rms	<15 Hz rms
0.05 to 15 kHz	<30 Hz rms	<8 Hz rms	<16 Hz rms	<30 Hz rms

Residual AM (0.05 to 15 kHz post detection noise bandwidth): <-70 dBc.

Typical SSB Phase Noise (CW only)

Offset from Carrier	0.1 to 123.5 MHz (dBc/Hz)	123.5 to 247 MHz (dBc/Hz)	247 to 494 MHz (dBc/Hz)	494 to 990 MHz (dBc/Hz)
20 kHz	<-115	<-127	<-121	<-115
500 kHz	<-125	<-135	<-131	<-125

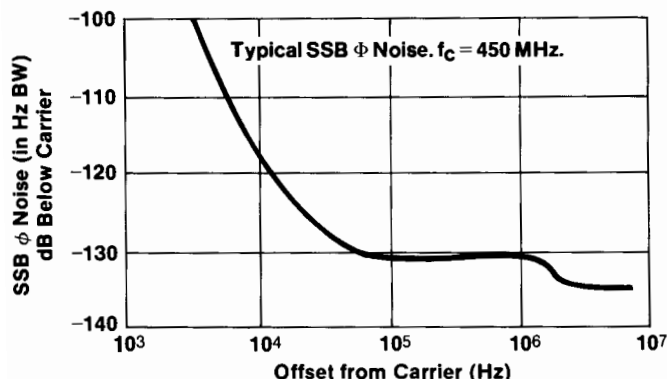

Output

Level range (into 50 ohms): +13 dBm to -127 dBm (3½ digit LED display; uncalibrated average to +17 dBm).

Resolution: 0.1 dB.

Absolute level accuracy: ±1.5 dB.

Level flatness (100 kHz to 990 MHz): ±1.0 dB at an output level setting of 0.0 dBm.

Reverse power protection: protects signal generator from application of up to 50 watts (typical) of RF power to 990 MHz into generator output; dc voltage cannot exceed 25 V.

Modulation

Amplitude Modulation (2 digit LED display)

AM depth¹: 0 to 99% to +7 dBm and 0 to 30% to +10 dBm.

Resolution: 1%.

AM rate: internal 400 Hz and 1 kHz, ±3%; external (1 dB bandwidth), 25 Hz to 25 kHz.

AM distortion (at internal rates): <1.5%, 0-30% AM; <3%, 31-70% AM; <5%, 71-90% AM.

Indicator accuracy (for depths <90% and internal rates)¹: (±4% of reading) ±2%.

Incidental phase modulation (at 30% AM depth and internal rates): <0.3 radian peak.

Frequency Modulation (2 digit LED display)

FM Peak Deviation

Center Frequency (f_c)	Maximum Peak Deviation (Δf_{pk}) [*]	
	Rates ≥ 60 Hz	Rates < 60 Hz
0.1-123.5 MHz	99 kHz	1600 x Rate
123.5-247 MHz	25 kHz	400 x Rate
247-494 MHz	50 kHz	800 x Rate
494-990 MHz	99 kHz	1600 x Rate

^{*}FM not specified for $f_c - \Delta f_{pk} < 100$ kHz.

Resolution: 100 Hz for deviations less than 10 kHz; 1 kHz for deviations greater than 10 kHz.

FM rate: internal 400 Hz and 1 kHz, ±3%; external (1 dB bandwidth, ac coupled), 25 Hz to 25 kHz.

FM distortion (for 100 Hz to 99 kHz peak deviations and internal rates): <0.5% THD.

Indicator accuracy¹: ±5% of reading at internal rates. (Add ±5% if 250 Hz frequency increments are used).

Incidental AM (for center frequency ≥500 kHz, peak deviation <20 kHz and internal rates): <0.1%.

Digital FM: will accept typical digital unquenching signals. Sag of resultant demodulated signal is typically less than 8% at 1 kHz deviation for a 10 Hz square-wave modulating signal.

Remote Programming

Interface: HP-IB (Hewlett-Packard's implementation of IEEE Standard 488).

Interface functions implemented: SH1, AH1, T0, L2, SRO, RL1, PP0, DC1, DT0, and C0.

General

Operating temperature range: 0 to +55°C.

Leakage: conducted and radiated interference is within the requirements of methods CE03 and RE02 of MIL STD 461A, VDE 0871, and CISPR Publication 11. Furthermore, RF leakage of less than 1.0 μ V is induced in a two-turn loop, 2.5 cm in diameter, held 2.5 cm away from the front surface.

Power requirements: 100, 120, 220, or 240 V, (+5, -10%); 48 to 66 Hz; 125 VA maximum.

Weight: net, 18.1 kg (40 lb). Shipping, 24.5 kg (54 lb).

Size: 133 H x 425 W x 520 D mm (5.25" x 16.75" x 20.5"). 5.25" x 1 MW x 17", system II module. For cabinet accessories, see pages 714-719.

Rack slides and transit case: HP part numbers are: slide kit, 1494-0018; tilt slide kit, 1494-0025; full module transit case, 9211-2661.

Ordering Information

8656A Signal Generator²

Option 001: High stability time base

Option 002: Rear panel input and output

Option 907: Front handle kit

Option 908: Rack flange kit

Option 909: Rack flange and front handle kit

Option 910: Extra operating & service manual

¹AM depth and FM deviation are further limited by Indicator Accuracy specifications.

²HP-IB cables not supplied, see page 37 for description and prices.



SIGNAL GENERATORS

Synthesized Signal Generators

Models 8662A, 8663A

- 10 kHz to 1280 MHz frequency range
- < -147 dBc/Hz SSB phase noise at 10 kHz offset
- 0.1 Hz frequency resolution

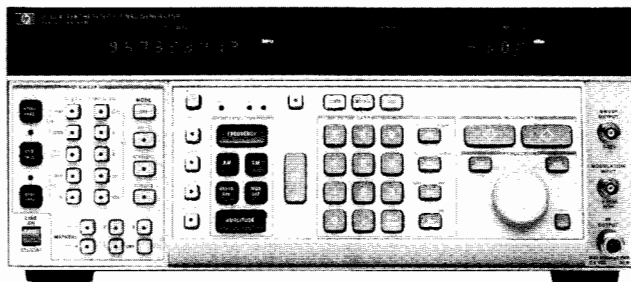

8662A



8662A Synthesized Signal Generator

The 8662A derives exceptional RF performance from an indirect frequency synthesis technique that results in frequency resolution of 0.1 Hz from 10 kHz to 640 MHz and .2 Hz from 640 MHz to 1280 MHz.

Output level accuracy is held to ± 1 dB using microprocessor correction. This makes the 8662A an ideal generator for performing precise receiver sensitivity tests either manually or in automated systems.

The 8662A offers versatile phase-locked AM/FM using either internal 400 Hz and 1 kHz rates or externally applied modulating signals, which can be either dc or ac coupled. Several different modes of simultaneous modulation (such as AM + FM or FM + FM) are possible.

Exceptional Spectral Purity

The key contribution of the 8662A is spectral purity. Fast-tuning, switched-inductance, voltage-controlled oscillators combined with a low noise reference multiplication chain result in very low SSB phase noise, especially at small offsets from the carrier. The phase noise at 20 kHz to 50 kHz offsets is comparable to that of the best cavity-tuned fundamental oscillators. Such excellent noise performance makes possible complete automation of receiver out-of-channel measurements.

With its excellent long and short-term frequency stability, high output power, fine frequency resolution, and broad frequency range the 8662A also meets the requirements of the most critical low noise local oscillator applications. In addition, its fast frequency switching and sweep capabilities also permit its use in many frequency agile and swept local oscillator applications.

An advanced microprocessor-based controller allows convenient keyboard control of all 8662A functions. For example, all functions can be incremented and decremented in any user-defined step size within the resolution of the synthesizer using the increment keys and the knob. Up to nine full front panel setups can be stored in the 8662A's memory and recalled for later use in any user-defined sequence at the touch of a pushbutton. This permits time-saving semi-automation of generator operation in production setups where the generator must perform many different tests.

Precision Digital Sweep

Fast frequency switching combined with microprocessor control gives the 8662A a powerful sweep capability. Automatic, single, and manual modes are available for both linear and logarithmic sweeps with user-selectable step size and number of steps. Five different sweep speeds can be chosen and up to five amplitude or Z-axis markers can be set. All sweep parameters can be controlled with full synthesizer resolution.

- 100 kHz to 2560 MHz frequency range
- AM/FM/PM/pulse in one generator
- Internal variable modulation oscillator

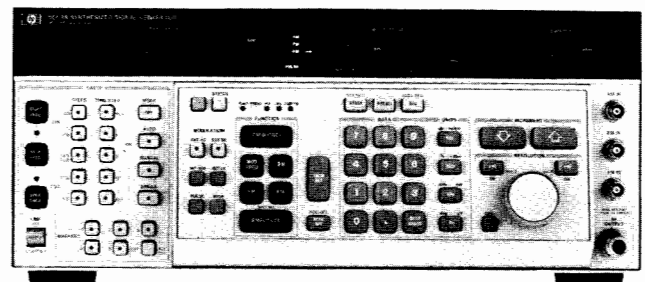

8663A



8663A Synthesized Signal Generator

The 8663A provides all the features and the exceptional spectral purity of the 8662A with increased frequency range and modulation capability.

Broad Frequency Range

The 8663A utilizes the complete frequency synthesis portion of the 8662A with the addition of an internal frequency doubler to achieve a broad frequency range of 100 kHz to 2560 MHz in a single instrument. In the 8663A, the exceptional spectral purity of the 8662A is maintained up to 1280 MHz. Above this, phase noise is typically increased 6 dB to a level of -124 dBc/Hz at 10 kHz offset from a 2.5 GHz carrier. High output power of +16 dBm (with overrange to 19.9 dBm) is available for efficiently driving frequency translators when low noise microwave signals are needed. Combined with a microwave synthesizer such as the HP 8673A, full frequency coverage from 100 kHz to 26 GHz is possible.

Flexible Modulation

Complete modulation capability across a wide carrier frequency range is the key contribution of the 8663A. AM and FM characteristics are similar to those offered in the 8662A. The 8663A adds high performance pulse and biphasic modulation with wide bandwidth linear phase modulation available with option 002. For complete flexibility, and 8663A option 002 has the capability to simultaneously provide AM+FM+pulse+phase modulation across its entire frequency range. AM, FM, and linear phase are either AC or DC coupled while biphasic and pulse are DC coupled. This modulation flexibility assures exact signal simulation when testing complex systems such as those involving pulsed doppler radar and electronic warfare. An internal 100 kHz sinusoidal modulation synthesizer phase locked to the 10 MHz time base is standard. Microprocessor flexibility allows the sweep functions to be applicable to the internal audio synthesizer as well as the RF synthesizer making applications involving swept modulation possible with a single instrument.

Similarity to the 8662A

Because the 8663A has been designed to be upward compatible with the 8662A, the two generators have identical control and performance characteristics for those functions that are common. Either generator can be combined with the HP 11729A Microwave Converter and the HP 3047A Spectrum Analyzer to perform microwave phase noise measurements simply and quickly.



8662A Specifications

Frequency

Range: 10 kHz to 1280 MHz (1279.9999998 MHz).

Resolution: 0.1 Hz (0.2 Hz above 640 MHz).

Accuracy and stability: same as reference oscillator.

Internal reference oscillator: 10 MHz quartz oscillator. Aging rate $< 5 \times 10^{-10}$ /day after 10 day warm-up (typically 24 hrs in normal operating environment).

Spectral Purity

Residual SSB Phase Noise in 1 Hz BW ($320 \leq f_c < 640$ MHz)

Offset from carrier				
10 Hz	100 Hz	1 kHz	10 kHz	100 kHz
-100 dBc	-112 dBc	-121 dBc	-131 dBc	-132 dBc

SSB broadband noise floor in 1 Hz BW at 3 MHz offset from carrier: < -146 dBc for f_c between 120 and 640 MHz at output levels above +10 dBm.

Spurious Signals

	Frequency range (MHz)				
	0.01 to 120	120 to 160	160 to 320	320 to 640	640 to 1280
Spurious non-harmonically related ^{1,2}	-90 dBc	-100 dBc	-96 dBc	-90 dBc	-84 dBc
Sub-harmonically related ($\frac{f}{2}$, $\frac{3f}{2}$, etc.)	none	none	none	none	-75 dBc
Power line (60Hz) related or microphonically generated (within 300 Hz) ³ .	-90 dBc	-85 dBc	-80 dBc	-75 dBc	-70 dBc
Harmonics	< -30 dBc				

Output

Level range: +13 to -139.9 dBm (1 V to $0.023 \mu\text{V}_{\text{rms}}$ into 50 Ω).

Resolution: 0.1 dB.

Absolute level accuracy (+15° to +45°C): ± 1 dB between +13 and -120 dBm, ± 3 dB between -120 and -130 dBm.

SWR: typically from 1.5 to 1.8 depending on output level and frequency.

Reverse power protection: typically up to 30W or ± 8 Vdc.

Amplitude Modulation

Depth: 0 to 95% at output levels of +8 dBm and below (+10 dBm in uncorrected mode). AM available above these output levels but not specified.

Resolution: 1%, 10 to 95% AM; 0.1%, 0 to 9.9% AM.

Incidental PM (at 30% AM): 0.15–640 MHz, < 0.12 radian peak; 640–1280 MHz, < 0.09 radian peak.

Incidental FM (at 30% AM): 0.15–640 MHz, $< 0.12 \times f_{\text{mod}}$; 640–1280 MHz, $< 0.09 \times f_{\text{mod}}$.

Indicated accuracy: $\pm 5\%$ of reading $\pm 1\%$ AM. Applies for rates given in table below, internal or external mode, for depths $\leq 90\%$.

Rates and Distortion with Internal or External Modulating Signal

Frequency range	AM Distortion			
	AM rate	0-30% AM	30-70% AM	70-90% AM
0.15-1 MHz	dc-1.5 kHz	2%	4%	5.75%
1-10 MHz	dc-5 kHz	2%	4%	5.75%
10-1280 MHz	dc-10 kHz	2%	4%	5.75%

Frequency Modulation

FM rates (1 dB bandwidth): external ac, 20 Hz to 100 kHz; external dc, dc to 100 kHz.

FM deviation: from 25 to 200 kHz depending on carrier frequency.
Indicated FM accuracy: $\pm 8\%$ of reading plus 10 Hz (50 Hz to 20 kHz).

FM resolution: 100 Hz for deviations < 10 kHz, 1 kHz for deviations ≥ 10 kHz.

Incidental AM (AM sidebands at 1 kHz rate and 20 kHz deviation): < -72 dBc, $f_c < 640$ MHz; < -65 dBc, $f_c \geq 640$ MHz.

FM distortion: $< 1.7\%$ for rates < 20 kHz, $< 1\%$ for rates < 1 kHz.

Center frequency accuracy and long term stability in AC mode: same as CW mode.

Supplemental Characteristics

Typical SSB Phase Noise

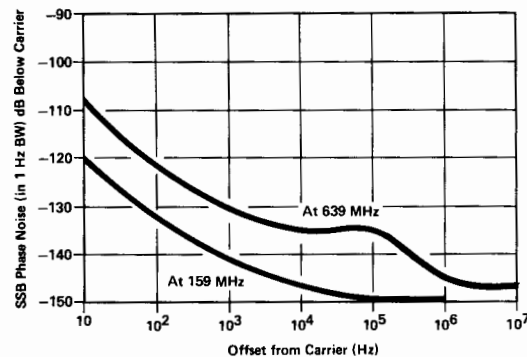

Frequency switching speed:⁴ From 420 μsec to 12.5 msec, depending on the programming mode.

8663A Specifications

The 8663A signal generator is related to the 8662A in both concept and structure. The 8662A concept of an extremely low phase noise signal source incorporating signal generator modulation capabilities and output characteristics is carried even further by the 8663A. While maintaining high spectral purity, the 8663A offers increased frequency range to 2560 MHz, increased output level to +16 dBm, and the addition of phase and pulse modulation. The result is a highly flexible and powerful signal generator that utilizes and extends the proven circuitry of the 8662A. Thus, the 8662A and 8663A share many of the same specifications as shown below:

Frequency

Range: 100 kHz to 2560 MHz (2559.9999996 MHz)

Resolution: .1 Hz ($f_c < 640$ MHz)

.2 Hz ($640 \text{ MHz} \leq f_c < 1280$ MHz)

.4 Hz ($f_c \geq 1280$ MHz)

Accuracy, stability, and internal reference oscillator: identical to 8662A.

Spectral Purity

Residual SSB phase noise in 1 Hz BW ($320 \leq f_c < 640$ MHz): identical to 8662A.

Typical SSB phase noise: identical to the 8662A for f_c between 100 kHz and 1280 MHz (see graph). For f_c between 1280 and 2560 MHz, the noise will be approximately 12 dB higher than the 639 MHz curve on the "typical SSB phase noise" graph.

Spurious signals: identical to 8662A except for f_c between 1280 and 2560 MHz the spurious non-harmonics are -78 dBc, the sub-harmonically related ($f/2$, $3f/2$, etc.) are -40 dBc, and the power line (60 Hz) or microphonically generated spurious are -65 dBc.

Harmonics: < -30 dBc, $f_c < 1280$ MHz; < -25 dBc, $f_c \geq 1280$ MHz

Output

Level range: +16 dBm to -129.9 dBm

Resolution: .1 dB

Absolute level accuracy (+15° to +45°C): ± 1 dB, +16 dBm to -119.9 dBm; ± 3 dB for -120 dBm and below.

SWR: < 1.5



SIGNAL GENERATORS

Synthesized Signal Generators

Models 8662A, 8663A (cont.)

Amplitude Modulation

Depth: 0 to 95% at levels of +10 dBm and below

Resolution: .1%

Incidental FM (at 30% AM): identical to 8662A except: $<.3 \times f_{\text{mod}}$ for $1280 \leq f_c < 2560$ MHz

Indicated accuracy: $\pm 6\%$ of reading $\pm 1\%$ AM (400 Hz and 1 kHz, depth 90%)

AM Bandwidth (1dB)

DC to >1.5 kHz, $0.15 \text{ MHz} \leq f_c < 1 \text{ MHz}$;

DC to >5 kHz, $1 \text{ MHz} \leq f_c \leq 10 \text{ MHz}$;

DC to >10 kHz, $f_c > 10 \text{ MHz}$;

External dc coupling.

External ac coupling or internal; low frequency coupling is 20 Hz.

Distortion (400 Hz and 1 kHz): $<2\%$ (0–30% AM)
 $<4\%$ (30–70% AM)
 $<6\%$ (70–90% AM)

Frequency Modulation

FM rates (1 dB bandwidth): external ac, 20 Hz to 100 kHz, external dc, dc to 100 kHz.

Maximum allowable peak deviation: identical to 8662A for f_c between 100 kHz and 1280 MHz. Up to 400 kHz for f_c between 1280 and 2560 MHz.

Indicated FM accuracy (50 Hz to 20 kHz): $\pm 9\%$ of setting +10 Hz.

FM resolution: 100 Hz to 1 kHz depending on f_c and deviation setting.

Incidental AM (AM sidebands at 1 kHz rate and 20 kHz deviation)

< -72 dBc ($10 \leq f_c < 640$ MHz)

< -65 dBc ($640 \leq f_c < 2560$ MHz)

FM distortion: $<1.25\%$ (400 Hz and 1 kHz rates)
 $<1.75\%$ (rates less than 20 kHz)

Phase Modulation (option 002)

Maximum peak phase deviation: from $\pm 25^\circ$ for f_c between 120 and 160 MHz up to $\pm 400^\circ$ for f_c between 1280 and 2560 MHz.

Maximum rate: from 10 kHz for f_c between .15 and 10 MHz up to 10 MHz for f_c between 250 and 2560 MHz.

Phase deviation resolution: 1° ($.1 \leq f_c < 640$ MHz)
 2° ($640 \leq f_c < 1280$ MHz)
 4° ($1280 \leq f_c < 2560$ MHz)

Phase modulation distortion: 10% at maximum rate

Biphase Modulation

Biphase modulation is available on the standard 8663A for f_c less than 640 MHz and available for all f_c with option 002.

Deviation: $\pm 90^\circ$

Carrier null when modulated with 1 MHz, 50% duty cycle square wave: > 25 dBc.

Modulation input required: TTL positive true. The internal modulation oscillator can be used for 50% duty cycle modulation. External input is on rear panel.

Pulse Modulation⁵

Pulse on/off ratio: >80 dB (50–2560 MHz)

Pulse rise/fall time: <250 ns (50–120 MHz); <780 ns (120–640 MHz); <100 ns ($f_c \geq 640$ MHz)

Pulse Repetition Frequency (50% duty cycle):

Internal: 10 Hz to 99.9 kHz

External: 10 Hz to 2 MHz, 50 MHz $< f_c < 640$ MHz
 10 Hz to 5 MHz, $f_c > 640$ MHz

Internal Modulation Oscillator

Rates: 10 Hz to 99.9 kHz

Frequency resolution: 3 digits

Frequency accuracy: same as reference oscillator.

Output level (available on rear panel): 1 volt peak into 600 Ω

Output impedance: 600 Ω

Flatness (referenced to 1 kHz): $< \pm 1\%$

Distortion: $<1\%$

Other 8662A and 8663A Information

Remote programming: the HP-IB interface is standard on the 8662A and 8663A signal generators. All functions controlled from the front panel with the exception of the line switch are programmable with the same accuracy and resolution as in manual mode.

Operating temperature range: 0° to $+55^\circ\text{C}$.

Leakage: meets radiated and conducted limits of MIL STD 461A methods RE02 and CE03 as well as VDE 0871.

Power requirements: 115 (90–126) V or 230 (198–252) V; 48 to 66 Hz; 450 VA max.

Weight: 8662A: net 30 kg (65.5 lb.). Shipping 36 kg (80 lb.).

8663A: net 33.8 (74 lb.). Shipping 40 kg (88 lb.).

Size: 8662A: 178 mm H x 425 mm W x 572 mm D (7" x 16.75" x 22.5")

8663A: 178 mm H x 425 mm W x 642 mm D (7" x 16.75" x 25.3")

Note: depth includes front panel depth of 45 mm (1.75").

Ordering Information

8662A 1280 MHz Signal Generator⁶

Option 001: Rear panel RF output and mod input

Option 907: Front Handle kit

Option 908: Rack flange kit

Option 909: Rack flange & front handle kit

Option 910: Extra operating & service manual

11721A External frequency doubler for operation to 2.56 GHz (8662A only)

8663A 2560 MHz Signal Generator⁶

Option 001: Rear panel RF output and mod inputs

Option 002: Wideband linear phase modulation

Option 907: Front handle kit

Option 908: Rack flange kit

Option 909: Rack flange & front handle kit

Option 910: Extra operating & service manual

11714A Service Support Kit (required for servicing 8662A/8663A)

¹In the remote mode it is possible to have microprocessor clock related spurious signals spaced 3 MHz apart at an absolute level of typically less than -145 dBm.

²Spurious signals can be up to 3 dB higher in the dc FM mode.

³At a 50 Hz line frequency, power line or microphonically related spurious signals may be up to 3 dB higher and appear at offsets as high as 1 kHz from the carrier.

⁴Due to automatic leveling loop bandwidth changes, brief (30 msec) level inaccuracies may occur when switching through 150 kHz and 1 MHz RF output frequencies.

⁵Pulse modulation is available for $f_c < 50$ MHz but is unspecified.

⁶HP-IB cables not supplied, see page 37 for description and prices.

SIGNAL GENERATORS

Synthesized Signal Generators

Models 8660A and 8660C

345



- 10 kHz to 2600 MHz
- Synthesizer stability and accuracy
- 1 Hz resolution (2 Hz above 1300 MHz)

- Ten digit display
- Calibrated output over > 140 dB range
- AM, FM, Φ M, or pulse modulation

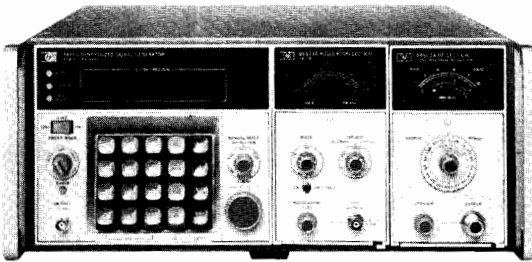

8660C

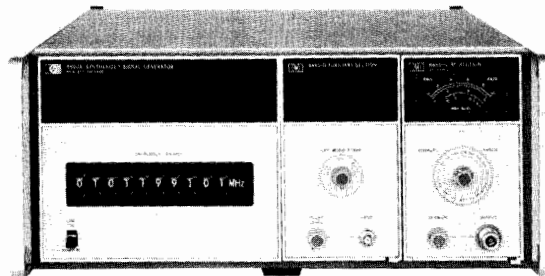

8660A

8660A, 8660C Synthesized Signal Generators

System Concept

The 8660 is a modular solid-state plug-in system. Each system includes: 1) a programmable synthesized signal generator mainframe. 2) an RF section plug-in, and 3) a modulation section. Synthesized accuracy and stability along with complete programmability make the 8660 ideal for most automated receiver and component testing situations.

Mainframes

There are two mainframes, the 8660A and 8660C which both offer a BCD or optional HP-IB interface and operation from an internal or external frequency reference. The 8660A mainframe uses thumb-wheel switches to select CW output frequencies. The 8660C mainframe provides direct keyboard entry of CW frequencies. Added capabilities of the 8660C include digital sweep, frequency stepping, control of frequency with a tuning knob, and a ten-digit numerical display.

Plug-In RF Sections

The 86601A (.01 - 110 MHz), 86602B (1 - 1300 MHz), and 86603A (1 - 2600 MHz) are the three RF section choices. The 11661B Frequency Extension Module (mainframe option 100) must be used with the 86602B and 86603A and is installed internal to an 8660 mainframe. When using the 8660A mainframe, the 86603A plug-in must be ordered with option 003.

Plug-In Modulation

There are five modulation sections to choose from. The 86631B Auxiliary Section provides external AM and pulse modulation. The 86632B offers AM and FM and utilizes a free-running VCO to provide high FM deviations and rates while the 86633B provides AM and phase locked FM. The 86634A offers high performance phase modulation with rates to 10 MHz while the 86635A provides both FM and phase modulation. (The 86634A and 86635A must be used with option 002 RF Section.)

8660A, 8660C Mainframe Specifications

Frequency accuracy and stability: CW frequency accuracy and long term stability are determined by internal reference oscillator (3×10^{-8} /day), or by external reference.

Reference Oscillator

Internal: 10 MHz quartz oscillator. Aging rate less than ± 3 parts in 10^8 per 24 hours after 72 hours warm-up (± 3 parts in 10^9 per 24 hours, Option 001).

External: rear panel switch allows operation from 5 MHz or 10 MHz frequency standard at a level between 0.5 and 2.5 Vrms into 170 ohms.

Reference output: rear panel BNC connector provides output of reference signal selected at level of at least 0.5 Vrms into 170 ohms.

Digital sweep (8660C): auto, single, or manual. Selectable speeds 0.1, 1, or 50 seconds.

Remote Programming

Functions

8660A: all front panel frequency and output level (and most modulation functions) are programmable.

8660C: CW frequency, frequency stepping (STEP \downarrow , STEP \uparrow), output level, and most modulation functions are programmable. Note: digital sweep is NOT programmable.

Programming Input

Connector type: 36-pin Cinch type 57 (mating connector supplied). 24-pin Cinch type 57 for optional HP-IB interface (mating connector NOT supplied).

Logic: TTL compatible (negative true).

Switching time: less than 5 ms to be within 100 Hz of any new frequency selected. (Less than 100 ms to be within 10 Hz.)

General

Operating temperature range: 0 to +55°C.

Power: 100, 120, 220, or 240 volts +5%, -10%, 48-66 Hz; approximately 350 watts.

Weight (mainframe only): net 23.2 kg (51 lb). Shipping, 28.6 kg (63 lb).

Supplemental Characteristics

Typical Single Sideband Phase Noise

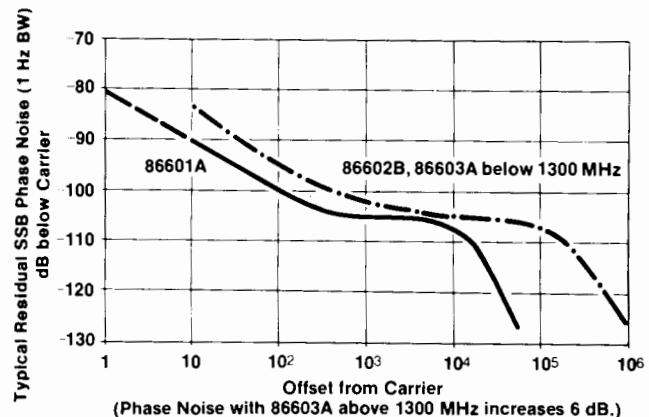

SIGNAL GENERATORS

Synthesized Signal Generators

Models 8660A & 8660C (cont.)

10 kHz to 110 MHz

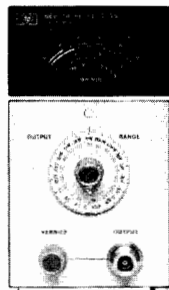

86601A

1 MHz to 1300 MHz

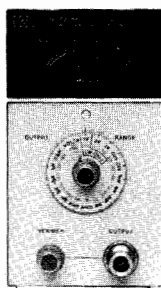

86602B (11661B required)

1 MHz to 2600 MHz

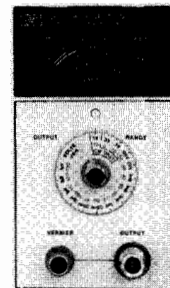

86603A (11661B required)

RF Section Specifications (installed in 8660A or 8660C mainframe)

		86601A	86602B (requires 11661B)	86603A (requires 11661B)		
FREQUENCY CHARACTERISTICS	Frequency Range	0.01–110 MHz (109.999999 MHz)	1–1300 MHz (1299.999999 MHz)	1–2600 MHz (2599.999998 MHz)		
	Frequency Resolution	1 Hz	1 Hz	CF < 1300 MHz	CF ≥ 1300 MHz	
	Harmonics	< -40 dBc	< -30 dBc (< -25 dBc above +3 dBm)		< -20 dBc ¹	
	Spurious Non Harmonically Related	-80 dBc	-80 dBc below 700 MHz -80 dBc above 700 MHz within 45 MHz of carrier -70 dBc above 700 MHz > 45 MHz from carrier -50 dBc on +10 dBm range		-74 dBc within 40 MHz of carrier ¹ -64 dBc > 45 MHz from carrier < -64 dBc	
	Power Line Related (CW, AM, φM only) ²	-70 dBc	< -70 dBc		< -64 dBc	
	Signal To Phase Noise Ratio (CW, AM, φM only) ²	> 50 dB	> 45 dB		> 39 dB	
OUTPUT CHARACTERISTICS	Output Level (into 50 Ω)	+13 dBm to -146 dBm	+10 to -146 dBm	+10 to -136 dBm	+7 to -136 dBm ³	
	Output Accuracy (local and remote)	± 1 dB, +13 to -66 dBm ± 2 dB, -66 to -146 dBm	± 1.5 to -76 dBm ± 2.0 to -146 dBm	± 2.5 dB to -76 dBm ³ ± 3.5 dB to -136 dBm		
	Flatness (output level variation with frequency)	< ± 0.75 dB	< ± 1.0 dB	< ± 2.0 dB (1–2600 MHz)		
	Impedance	50 Ω				
MODULATION CHARACTERISTICS	AM	AM Modulation Depth	0 to 95%	0 to 90% ⁴	0 to 50% ⁴	
		3 dB Bandwidth:	0–30%	200 Hz, CF < 0.4 MHz 10 kHz, 0.4 ≤ CF < 4 MHz 100 kHz, CF ≥ 4 MHz	10 kHz, CF < 10 MHz 100 kHz, CF ≥ 10 MHz	10 kHz
			0–70%	125 Hz, CF < 0.4 MHz 6 kHz, 0.4 ≤ CF < 4 MHz 60 kHz, CF ≥ 4 MHz	6 kHz, CF < 10 MHz 60 kHz, CF ≥ 10 MHz	N/A
			0–90%	100 Hz, CF < 0.4 MHz 5 kHz, 0.4 ≤ CF < 4 MHz 50 kHz, CF ≥ 4 MHz	5 kHz, CF < 10 MHz 50 kHz, CF ≥ 10 MHz	N/A
		Distortion, THD at 30% AM at 70% AM at 90% AM	< 1%, 0.4–110 MHz < 3%, 0.4–110 MHz < 5%, 0.4–110 MHz	< 1% < 3% < 5%	< 5% N/A N/A	
	FM	FM Rate	dc to 1 MHz with 86632B 20 Hz to 100 kHz with 86633B	dc to 200 kHz with 86632B and 86635A 20 Hz to 100 kHz with 86633B		
		Maximum Deviation (peak)	1 MHz with 86632B 100 kHz with 86633B	200 kHz with 86632B and 86635A 100 kHz with 86633B	400 kHz w/86632B, 86635A 200 kHz w/86633B	
		Distortion, THD (at rates up to 20 kHz)	< 1% up to 200 kHz dev. < 3% up to 1 MHz dev.	< 1% up to 200 kHz dev. < 1% up to 400 kHz dev.		
	PULSE	Pulse Rise/Fall Time	200 ns	50 ns		
		ON/OFF Ratio (with pulse level control at max.)	> 50 dB	> 40 dB		
φM ⁶	φM Rate	N/A	dc to 1 MHz with 86635A dc to 1 MHz for CF < 100 MHz dc to 10 MHz for CF ≥ 100 MHz with 86634A			
	Maximum Peak Deviation	N/A	0 to 100 degrees			
	Distortion, THD	N/A	< 5% up to 1 MHz rates < 7% up to 5 MHz rates < 15% up to 10 MHz rates			
GENERAL	Weight	Net 5 kg (11 lb) Shipping 6.8 kg (15 lb)	Net 4.1 kg (9 lb) Shipping 5.5 kg (12 lb)	Net 5 kg (11 lb) Shipping 6.4 kg (14 lb)		
		11661B: Net 2.3 kg (5 lb); shipping 2.7 kg (6 lb)				

¹For output levels +3 dBm and below; slightly higher +3 to +7 dBm.

²Measured in a 30 kHz band centered on the carrier excluding a 1 Hz band centered on the carrier.

³For +3 to +7 dBm output levels, output accuracy and flatness will be slightly degraded (above 1300 MHz only)

⁴For RF output level meter readings from +3 dB to -6 dB and only at +3 dBm and below.

⁵Applies only at 400 Hz and 1 kHz rates with output meter set between 0 and +3 dB. At -6 dB meter setting the distortion approximately doubles.

⁶Phase modulation is only possible with Option 002 RF Sections.

Pulse / AM

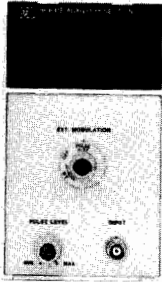

86631B

AM/High Deviation FM

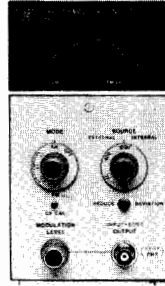

86632B

AM/φ Locked FM

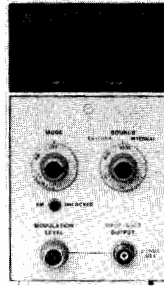

86633B

High rate φM

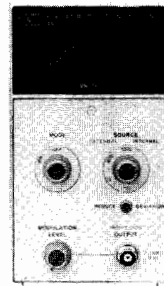

86634A

φM / FM

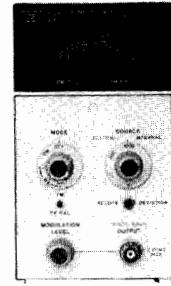

86635A

Modulation Section Specifications

		86631B	86632B	86633B	86634A	86635A
AM	Functions	Ext. Only	Int. and Ext.	Int. and Ext.	—	—
	Indicated Accuracy (at 400 and 1000 Hz rates)	—	±5% of full scale With 86601A RF Section: ±7%, center frequency ≥100 MHz. With 86603A RF Section: ±10%, center frequency ≥1300 MHz.		—	—
FM	Functions	—	Int. and Ext., FM CF CAL	Int. and Ext.	—	Int. and Ext., FM CF CAL
	Center Frequency Long Term Stability	—	Typically less than 200 Hz/h	Same as in CW Mode (3 x 10 ⁻⁸ /day)	—	Typically less than 200 Hz/h
	Indicated Accuracy (up to 20 kHz rates)	—	±5% of full scale		—	±5% of full scale
Pulse	Functions	Ext. Only	—	—	Int. and Ext.	Int. and Ext.
φM	Functions	—	—	—	Int. and Ext.	Int. and Ext.
	Indicated Accuracy (15°C to 35°C)	—	—	—	±5% of full scale up to 100 kHz rates ±8% of full scale up to 2 MHz rates ±15% of full scale up to 10 MHz rates	
Meter		—	0—100% AM 0—10, 100, 1000 kHz FM Pk. Dev. (0—20, 200, 2000 kHz FM for CF ≥1300 MHz)	0—100% AM 0—10, 100 kHz FM Pk. dev. (0—20, 200 kHz FM for CF ≥1300 MHz)	0—100° Peak φM (0—200° for CF ≥ 1300 MHz)	0—10, 100, 1000 kHz FM, 0—100° Pk φM (0—20, 200, 2000 kHz FM, 0—200° Pk. φM for CF ≥1300 MHz)
Internal Modulation Source Output		None —	400 Hz and 1 kHz ±5% 200 mV minimum into 10kΩ. Available at front panel BNC connector			
Input Impedance		50 Ω Pulse 600 Ω AM	600 Ω	600 Ω	50 Ω	600 Ω
Weight		Net, 1.4 kg (3 lb) Shipping, 2.3 kg (5 lb)	Net, 2.7 kg (6 lb) Shipping, 4.1 kg (9 lb)	Net, 2.7 kg (6 lb) Shipping, 4.1 kg (9 lb)	Net, 1.8 kg (4 lb) Shipping, 3.2 kg (7 lb)	Net, 2.7 kg (6 lb) Shipping, 4.1 kg (9 lb)

Ordering Information

8660A Synthesized Signal Generator Mainframe

8660C Synthesized Signal generator Mainframe

Options for 8660A, 8660C

Option 001: ±3 × 10⁻⁹/day internal reference oscillator

Option 002: no internal reference oscillator

Option 003: operation from 50 to 400 Hz line

Option 004: 100 Hz frequency resolution (200 Hz above 1300 MHz)

Option 005: HP-IB programming interface

Note: HP-IB cables not supplied, see page 37.

Option 009: (8660A only) LED display indicates selected frequency in 1-2-4-8 BCD code

Option 100: 11661B factory installed inside mainframe

Option 908: Rack Flange Kit

86601A 0.01–110MHz RF Section

86602B 1–1300 MHz RF Section

86603A 1–2600 MHz RF Section

Note: 86602B and 86603A RF sections require an 11661B for operation.

Option 001: no RF output attenuator (all RF Sections)

Option 002: adds phase modulation capability (86602B, 86603A only)

Option 003: allows operation of 86603A with 8660A mainframe

11661B Frequency Extension Module

86631B Auxiliary Section

86632B AM/FM Modulation Section

86633B AM/FM Modulation Section

86634A φM Modulation Section

86635A φM/FM Modulation Section

11672A Service Accessory Kit

11707A Test Plug-in



SIGNAL GENERATORS

Mechanically Tuned VHF Generator

Models 8640A, 8640B

- 0.5 to 512 MHz frequency range with optional coverage to 1024 MHz
- +19 to -145 dBm output power range
- Low SSB phase noise
- Calibrated, metered AM, FM, and pulse modulation
- 8640B also features: internal phase lock/synchronizer, digital frequency readout, external count capability to 550 MHz

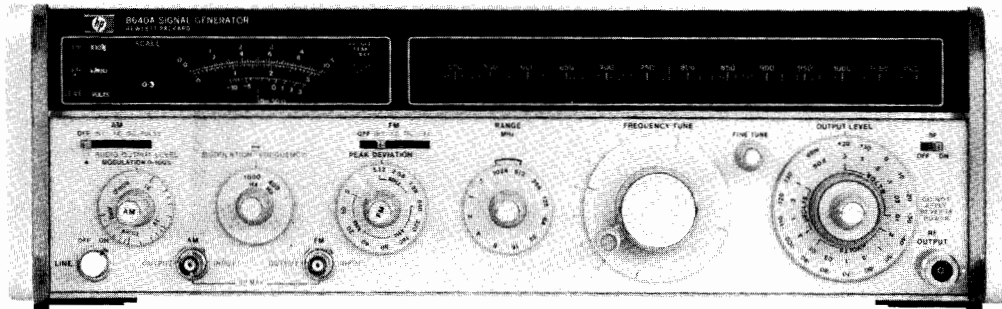

8640A (with Option 002)

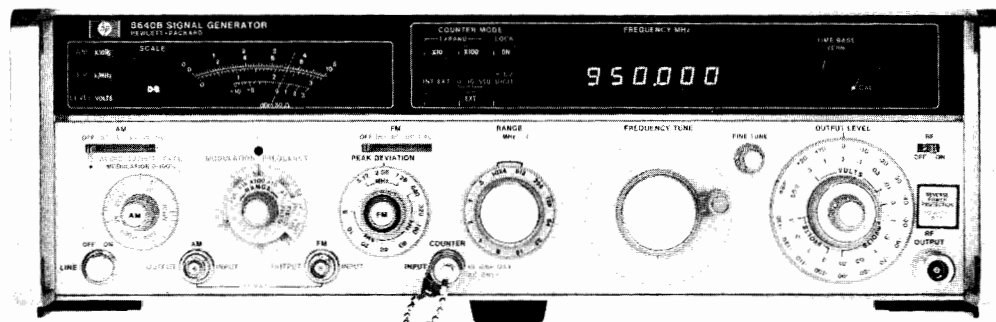

8640B (with Option 001, 002, 003)

8640A and 8640B Signal Generators

The 8640 Signal Generator covers the frequency range 500 kHz to 512 MHz (450 kHz to 550 MHz with band overrange) and can be extended to 1024 MHz with an internal doubler (Opt 002). Using the 11710B Down Converter, the 8640 frequency range can be extended down to 10 kHz. An optional audio oscillator (Opt 001) is also available with a frequency range of 20 Hz to 600 kHz. This broad coverage, together with calibrated output and modulation, provides for complete RF and IF performance tests on virtually any type of HF, VHF, or UHF receiver.

Both solid state generators, 8640A and B have an output level range of +19 to -145 dBm (2V to 0.013 μ V) which is calibrated, metered, and leveled to within ± 0.5 dB across the full frequency range of the instrument.

The 8640A and 8640B generators provide AM, FM, and pulse modulation for a wide range of receiver test applications. This modulation is calibrated and metered for direct readout under all operating conditions.

A reverse power protection option (Opt 003) is available to eliminate instrument damage due to accidental transmitter keying. This module protects against up to 50 watts of applied power and automatically resets upon removal of the reverse power.

Spectrally Pure Output Signals

Noise performance of the 8640 is state-of-the-art for a solid-state generator. The high-Q cavity oscillator has been optimized with use of a low-noise microwave transistor for spectrally pure output signals. At a 20 kHz offset from the carrier, SSB phase noise is < -130 dBc for carrier frequencies from 230 to 450 MHz, and rises to -122 dBc at 550 MHz. The SSB phase noise level decreases by approximately 6 dB for each division of the output frequency down to the broadband noise floor of better than 140 dB/Hz. This exceptional noise performance is also preserved during FM modulation and in the phase-locked mode of the 8640B.

Mechanical Dial or Built-in Counter

There are two versions of the 8640 Signal Generator. The 8640A has an easy-to-read slide rule dial with scales for each of the 10 output frequency ranges. There is an additional scale to provide direct readout of the output frequency even in the Option 002 INTERNAL DOUBLER band, 512-1024 MHz.

The 8640B combines the same performance features as the 8640A with a built-in 550 MHz frequency counter and phase lock synchronizer.

The internal 6 digit counter displays the output frequency and can also be used to count external input signals from 20 Hz to 550 MHz. This eliminates the need for a separate frequency counter in many measurement systems.

Internal Pushbutton Synchronizer

At the push of a button, the 8640B built-in phase lock synchronizer locks the RF output frequency to the crystal time base used in the counter. In this locked mode, the output stability is better than $5 \times 10^{-8}/h$ and the spectral purity and FM capability of the unlocked mode are preserved. For higher stability, it is possible to lock to an externally applied 5 MHz standard. Two 8640B's can also be locked together for various 2-tone measurements.

In the phase locked mode, increased resolution is available by using the $\frac{1}{2}$ digit increment button. For example, 500 Hz resolution is possible for frequencies between 100 and 1000 MHz.

FM While Phase Locked

In the phase locked mode, full FM capability is preserved down to modulation rates of 50 Hz. The narrow bandwidth of the phase lock loop (< 5 Hz) provides for FM modulation up to 250 kHz rates and assures no degradation in noise from the unlocked mode. This crystal stability, coupled with the precision modulation and low noise, makes the 8640B ideal for testing narrowband FM or crystal-controlled receivers.

8640A and 8640B Specifications

(See technical data sheet for complete specifications.) All specifications apply over the nominal frequency ranges and over the top 10 dB of the output level vernier range unless otherwise specified.

Frequency

Range: 500 kHz to 512 MHz in 10 octave ranges (to 1024 MHz with option 002 internal frequency doubler).

Ranges and range overlap: ranges extend approximately 10% below and 7% above the nominal frequency ranges shown below.

Frequency ranges (MHz)		
0.5-1	8-16	128-256
1-2	16-32	256-512
2-4	32-64	512-1024
4-8	64-128	(opt 002)

Fine Tuning

8640A and 8640B unlocked: > 1000 ppm total range.

8640B locked mode: > ± 20 ppm by varying internal time base vernier.

Internal Counter Resolution (8640B unlocked)

Frequency Ranges (MHz)	Normal Mode	Expand X10	Expand X100
0.5-1	10 Hz	1 Hz	0.1 Hz
1-16	100 Hz	10 Hz	1 Hz
16-128	1 kHz	100 Hz	10 Hz
128-1024	10 kHz	1 kHz	100 Hz

Optimum Counter Resolution When Phase-Locked (8640B)

Frequency Ranges (MHz)	With 6 Digits	+ 1/2 Digit
0.5-0.9999995	1 Hz	0.5 Hz
1.0-9.999995	10 Hz	5 Hz
10.0-99.99995	100 Hz	50 Hz
100.0-999.9995	1 kHz	500 Hz
1000-1024	10 kHz	5 kHz

Accuracy

8640A: mechanical dial; accuracy better than ± 1.0%, resetability better than 0.1%.

8640B: 6½ digit LED display with X10 and X100 expand; accuracy depends on internal or external reference used.

Stability (after 2 hour warmup)

Normal: < 10 ppm/10 min.

Locked: (8640B) < 0.05 ppm/h.

Restabilization Time After Frequency Change

Normal: < 15 min.

Locked (8640B): < 1 min. after relocking to be within 0.1 ppm of steady state frequency.

Output

Range: 10 dB steps and 18 dB vernier provide the following output power settings into 50Ω.

Frequency Range (MHz)	8640A/B	With Option(s)		
		002	003	002/003
0.5 to 512	+19 to -145 dBm	+18.5 to -145 dBm	+18.5 to -145 dBm	+18 to -145 dBm
512 to 1024 (Option 002)		+13 to -145 dBm		+12 to -145 dBm

Level Flatness (referred to output at 50 MHz and applies to 1 V range and for top 10 dB of vernier range)

Frequency Range (MHz)	8640A 8640B	With Option(s)		
		002	003	002/003
0.5 to 64	± 0.5 dB	± 0.75 dB	+0.75 dB -1.25 dB	+1.0 dB -2.0 dB
64 to 512		± 1.0 dB		
512 to 1024 (Option 002)		± 1.5 dB		± 2.0 dB

Level accuracy: (worst case as indicated on level meter) ± 1.5 dB to ± 4.5 dB depending on level, frequency, and options installed.

Spectral Purity

Harmonics (at 1 volt, +10 dBm output range and below)

> 30 dB below fundamental, 0.5 to 512 MHz.

> 12 dB below fundamental, 512 to 1024 MHz (option 002).

Spurious Output Signals (excluding frequencies within 15 kHz of the signal whose effects are specified in residual AM and FM)

Frequency Range (MHz)	Subharmonically Related		Non-harmonically Related	
	8640A	8640B	8640A	8640B
0.5 to 512	none detectable	< -100 dBc	none detectable	< -100 dBc
512 to 1024 (Option 002)	< -20 dBc			

¹dBc = dB below the carrier.

Residual AM (averaged rms): 0.3 to 3 kHz post-detection noise bandwidth > 85 dBc.

Residual FM (averaged rms): 0.3 to 3 kHz post-detection noise bandwidth. (CW and up to 1/4 maximum allowable peak deviation.)
0.5 to 512 MHz: < 5 Hz.
512 to 1024 MHz: < 10 Hz.

Measured SSB noise (typical): in graph below, triangular markers indicate specified limits.

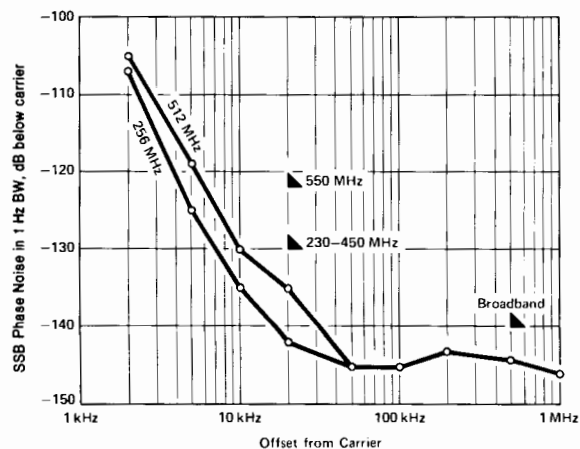



SIGNAL GENERATORS

Precision, High Stability, AM-FM VHF Signal Generator

Models 8640A, 8640B (cont.)

Modulation

General

Types: internal AM and FM; External AM, FM, and PULSE; simultaneous AM and FM or PULSE and FM.

Internal modulation sources (independently adjustable output level is available at front panel):

Standard: 8640A or 8640B.

Frequency: fixed 400 Hz and 1 kHz, $\pm 3\%$.

Output level: 10 mV to 1 V rms into 600 Ω .

Optional (internal variable audio oscillator Option 001, 8640A or 8640B):

Frequency: variable 20 Hz to 600 kHz, $\pm 15\%$ plus fixed 400 Hz and 1 kHz $\pm 3\%$.

Output level: 1 mV to 3 V rms into 600 Ω .

Amplitude Modulation

Depth

0.5 to 512 MHz: 0 to 100% for output levels from +13 dBm and below.

512 to 1024 MHz: 0 to 100% for output levels of +7 dBm and below, excluding the top 6 dB of output vernier range.

AM rates: INT and EXT ac, 20 Hz to AM 3 dB bandwidth; EXT dc, dc to AM 3 dB bandwidth.

AM 3 dB Bandwidth

Frequency Ranges	0 to 50% AM	50 to 90% AM
0.5 to 2 MHz	20 kHz	12.5 kHz
2 to 8 MHz	40 kHz	25 kHz
8 to 512 MHz	60 kHz	50 kHz
512 to 1024 MHz	60 kHz	50 kHz

AM Distortion (at 400 Hz and 1 kHz rates)

Frequency Ranges	0 to 30% AM	30 to 50% AM	50 to 90% AM
0.5 to 512 MHz	<1%		<3%
512 to 1024 MHz	<10%	<20%	

External AM Sensitivity (400 Hz and 1 kHz rates)

0.5 to 512 MHz: (0.1 \pm 0.005)% AM per mV peak into 600 Ω with AM vernier at full clockwise position.

512 to 1024 MHz: nominal 0.1% AM per mV peak into 600 Ω with AM vernier at full clockwise position.

Indicated AM Accuracy (400 Hz and 1 kHz rates using internal meter)

0.5 to 512 MHz: $\pm 5.5\%$ of reading $\pm 1.5\%$ of full scale from 0 to 50 $^{\circ}$ C.

512 to 1024 MHz: not specified; each generator can be individually calibrated using operating manual procedure.

Peak Incidental Phase Modulation (at 30% AM)

0.5 to 128 MHz: <0.15 radian.

128 to 512 MHz: <0.3 radian.

512 to 1024 MHz: <0.6 radian.

Peak incidental frequency deviation: equals peak incidental phase modulation x modulation rate.

Pulse Modulation¹

	Frequency Ranges (MHz)					
	0.5-1	1-2	2-8	8-32	32-512	512-1024
Rise and Fall Times	<9 μ s	<4 μ s	<2 μ s	<1 μ s		<1 μ s typical
Pulse Repetition Rate	50 Hz to 50 kHz		50 Hz to 100 kHz	50 Hz to 250 kHz	50 Hz to 500 kHz	
Pulse Width Minimum ²	10 μ s		5 μ s	2 μ s		
Pulse ON/OFF ratio at max. vernier	>40 dB					>60 dB
Peak Input Required	Nominally +0.5 V (5 V max). Sinewave or pulse return to zero into 50 Ω					

¹Pulse performance degrades below 500 Hz repetition rates.
²For level accuracy within 1 dB of CW ($>0.1\%$ duty cycle).

Frequency Modulation

Deviation: maximum allowable deviation equals 1% of lowest frequency in each nominal output frequency range.

Frequency Range (MHz)	Maximum Peak Deviation (kHz)
0.5-1	5
1-2	10
2-4	20
4-8	40
8-16	80
16-32	160
32-64	320
64-128	640
128-256	1280
256-512	2560
512-1024	5120

FM 3 dB bandwidth: internal and external ac, 20 Hz to 250 kHz; external dc, dc to 250 kHz. (8640B locked mode: FM above 50 Hz only.)

FM Distortion (at 400 Hz and 1 kHz rates)

<1% for deviations up to $\frac{1}{2}$ maximum allowable.

<3% up to maximum allowable deviation.

External FM sensitivity: 1 volt peak into 600 Ω yields maximum deviation indicated on PEAK DEVIATION switch with FM vernier at full clockwise position.

Indicated FM accuracy (400 Hz and 1 kHz rates from 15 $^{\circ}$ to 35 $^{\circ}$ C, using internal meter): $\pm 7\%$ of reading +1.5% of full scale.

Incidental AM (at 400 Hz and 1 kHz rates)

0.5 to 512 MHz: $<0.5\%$ AM for FM up to $\frac{1}{2}$ maximum allowable deviation; $<1\%$ AM for FM at maximum allowable deviation.

512 to 1024 MHz (Opt 002): $<1\%$ AM for FM up to $\frac{1}{2}$ maximum allowable deviation; $<7\%$ AM for FM deviations up to maximum allowable.

Counter (8640B)

External RF Input

Frequency range: 1 Hz to 550 MHz.

Sensitivity: ≥ 100 mV rms into 50 Ω , ac only.

Resolution: 6-digit LED display.

Mode	Normal	Expand X10	Expand X100
0-10 MHz	100 Hz	10 Hz	1 Hz
10-550 MHz	10 kHz	1 kHz	100 Hz

External reference input: 5 MHz, nominally >0.5 V p-p (5 V maximum) into 1 k Ω .

Internal Reference (after 2 h warm-up and calibration at 25 $^{\circ}$ C)

Aging rate: <0.05 ppm/h; <2 ppm/90 days.

Temperature Drift

$< \pm 2$ ppm from 15 $^{\circ}$ to 35 $^{\circ}$ C.

$< \pm 10$ ppm from 0 $^{\circ}$ to 50 $^{\circ}$ C.

Typical overall accuracy (within 3 months of calibration and from 15 $^{\circ}$ to 35 $^{\circ}$ C): ± 2 ppm.

General

Operating temperature range: 0 to 55 $^{\circ}$ C.

Power requirements: 100 or 120 volts (+5%, -10%) from 48 to 440 Hz; or 220 or 240 volts (+5%, -10%) from 48 to 66 Hz. 175 VA max (Option 002: 190 VA max).

Weight (8640A and 8640B): net, 20.8 kg (46 lb). Shipping, 24.1 kg (53 lb).

Size: 140 H x 425 W x 476 D (5.5" x 16.75" x 18.75").

Ordering Information

8640A Signal Generator

8640B Signal Generator

Option 001: internal variable audio oscillator, 20 Hz to 600 kHz (8640A/B)

Option 002: internal doubler 512-1024 MHz (8640A/B)

Option 003: reverse power protection (8640A/B)

Option 004: avionics option (8640B only)

Option 908: rack mount kit (8640A/B)

Option 910: extra operating and service manual (8640A/B)

SIGNAL GENERATORS

Avionics VHF Signal Generator

Model 8640B Option 004



• Demodulated output from RF detector, ac and dc

• Phase shift less than 0.01° at 30 Hz

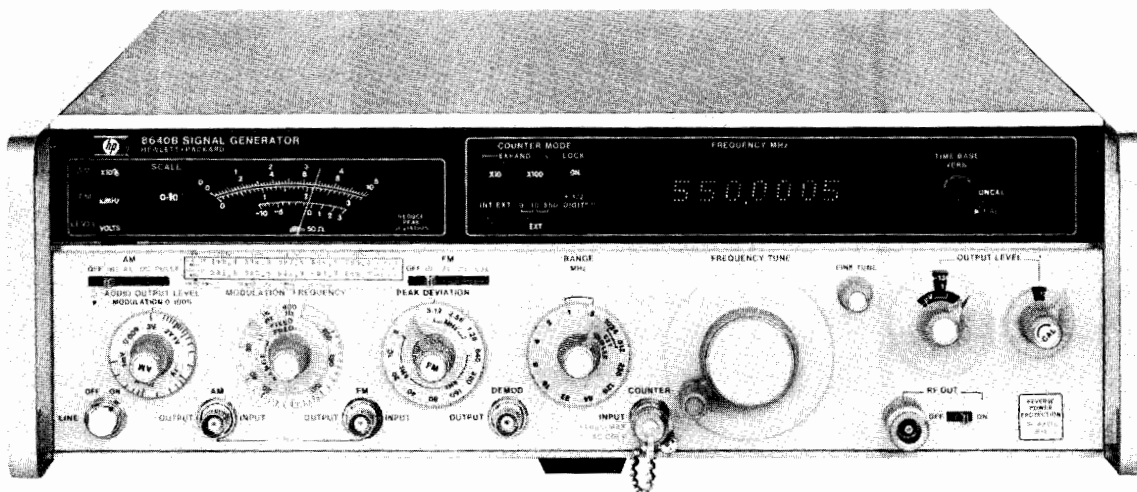

8640B Option 004 (with Options 001, 003)

8640B Avionics Option 004 Signal Generator

The Hewlett-Packard Model 8640B Option 004 NAV/COM Signal Generator is an 8640B AM/FM Signal Generator specially adapted for testing ILS (Marker Beacon, Localizer and Glide Slope), VOR and VHF communications receivers used throughout the aviation industry. VOR, LOCALIZER and VHF communications frequencies (108 to 136 MHz) are available on one frequency band for rapid channel selection. GLIDE SLOPE (329 to 335 MHz) and MARKER BEACON (75 MHz) frequencies are also easily set using the 6-digit LED display.

The 8640B Option 004 provides highly stable, spectrally pure RF signals for testing narrow-channel, crystal controlled receivers. For avionics testing, external audio generators are required to provide the composite modulation. Designed with versatile AM and FM modulation, Option 004 features low distortion modulation when used with suitable, external VOR/ILS Audio Generators.

Operation and specifications of the 8640B Option 004 are the same as the Standard 8640B AM/FM Signal Generator with the following additions:

Demodulated Output

One front panel BNC connector provides demodulated output from the RF peak detector for precise AM settings. A choice of combined ac/dc at 1 V rms or ac only at 5 V rms is provided.

Output Level Setting

To ensure the best possible demodulated output linearity, Option 004 combines a 10 dB step attenuator and a 1 dB step attenuator with a vernier. This provides output levels from +15 dBm to -142 dBm (1.3 V to 0.018 μ V). The output level can be read directly from the attenuator dial in dBm or from the front panel meter in dBm or volts.

External AM Input Impedance

External AM input impedance of 2 k Ω allows compatible operation with old and new generations of external audio generators.

Low Distortion Modulation

The 8640B Option 004 provides flat AM response and minimum phase shift at 30 Hz and 9960 Hz as well as constant group delay between 9 kHz and 11 kHz for accurate VOR and ILS testing.

8640B Option 004 Specifications

(These specifications apply to 8640B Option 004 in addition to standard 8640B specifications. See 8640B AM/FM Signal Generator technical data for complete specifications.)

Spectral Purity

Noise: SSB broadband noise floor greater than 1 MHz offset from carrier: > 130 dB down.

Output Characteristics

Range: +15 dBm to -142 dBm (1.3 V to 0.018 μ V).

Attenuators: a 10 dB step attenuator plus a 1 dB step attenuator with vernier allow selection of any output level over the full output level range.

Vernier: 2 dB continuously variable from a CAL detent position.

Level flatness (referred to 190 MHz and for +10 to -10 dBm): < ± 0.75 dB from 0.5 to 512 MHz; < ± 0.5 dB from 108 to 336 MHz.

Level Accuracy

Output Level (dBm)	+15 to -10	-10 to -50	-50 to -142	With Option 003
Total Accuracy as Indicated on Level Meter	± 1.5 dB	± 2.0 dB	± 2.5 dB	Add ± 0.5 dB except from 108 to 336 MHz

Modulation Characteristics

Demodulated output (output vernier in CAL position, 108 to 118 and 329 to 336 MHz): an internal selector switch allows selection of ac only or ac and dc at the demodulated output.

AC only output: directly proportional to AM depth (90 to 150 Hz modulation frequency).

%AM equals: (20 \pm 0.6)% per V rms, 0 to 55°C; (20 \pm 0.4)% per V rms, 20 to 30°C; (20 \pm 0.2)% per V rms (using calibration sheet provided).

AC and dc output: ac output voltage is directly proportional to AM depth (90 to 150 Hz modulation frequency). dc output equals (1.414 \pm 0.010) V dc with vernier in CAL position.

%AM equals: (100 \pm 3)% per V rms, 0 to 55°C; (100 \pm 2)% per V rms, 20 to 30°C; (100 \pm 1)% per V rms (using calibration sheet provided).

AM Characteristics (+10 dBm output and below)

External input impedance: nominally 2 k Ω .

Frequency response: < 0.04 dB from 90 Hz through 150 Hz (108 to 118 and 329 to 335 MHz.); < 0.1 dB, 9 kHz through 11 kHz (108 to 118 MHz); ± 3 dB (0 to 50% AM), dc through 50 kHz (8 to 512 MHz); ± 3 dB (0 to 70% AM), dc through 35 kHz (8 to 512 MHz).

Phase Shift From Audio Input to Demodulated Output (108 to 118 MHz, AM EXT DC mode, meter function on VOLTS)

30 Hz < $\pm 0.01^\circ$; 30 Hz to 10 kHz < $\pm 3^\circ$; 9 kHz to 11 kHz < $\pm 2^\circ$.

Ordering Information

8640B Signal Generator with Avionics Option 004

Option 001: Internal variable audio oscillator, 20 Hz to 600 kHz

Option 002: not available with Option 004

Option 003: Reverse power protection

Option 908: Rack mount kit

Option 910: Extra Operating and Service Manual



SIGNAL GENERATORS

AM-FM Solid-State Generator 10 to 520 MHz

Models 8654A, 8654B

- Calibrated output power
- Calibrated AM, FM; internal, external

- 25 Watt reverse power protection (optional)

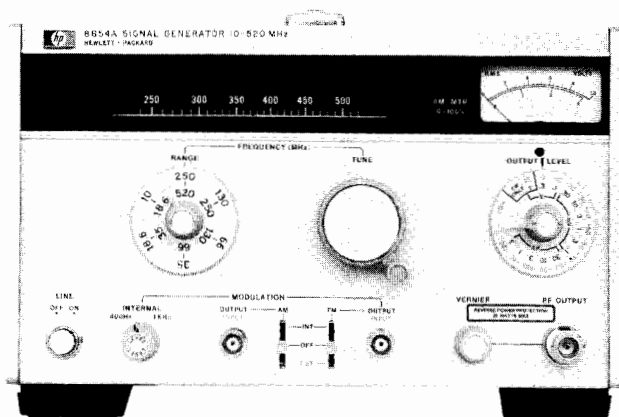

8654A

8654A/B Signal Generators

The HP 8654A/B Signal Generators are portable, low-cost solid-state generators providing calibrated output and versatile modulation capabilities over the 10 to 520 MHz frequency range. The 8654 provides clean RF signals for testing receivers, amplifiers, antennas, and filter networks.

Its compactness allows the 8654 to fit easily into production, mobile, airborne, and shipboard test locations. Its rugged, lightweight construction is also suitable for field maintenance and service applications.

Effective RF shielding and output range permit receiver sensitivity measurements to be made down to power levels of 0.1 μ V.

8654A/B Specifications

Frequency Characteristics

Range: 10 to 520 MHz in 6 ranges.

8654A ranges (MHz): 10 to 18.6, 18.6 to 35, 35 to 66, 66 to 130, 130 to 250, 250 to 520.

8654B ranges (MHz): 10 to 19, 19 to 35, 35 to 66, 66 to 130, 130 to 270, 270 to 520.

Accuracy: $\pm 3\%$ after 2-hour warm-up.

Settability: settleable to within 5 ppm of the desired frequency with an external indicator after 1-hour warm-up.

Stability (after 2-hour warm-up and 15 min. after frequency change): $< (1 \text{ kHz plus } 20 \text{ ppm})/5 \text{ min.}$

Spectral Purity

Harmonic distortion (output power $\leq +3 \text{ dBm}$): $< -20 \text{ dBc}$; $< -15 \text{ dBc}$ with Option 003.

Subharmonics and non-harmonic spurious (excluding line related): $< -100 \text{ dBc}$.

Residual AM (average rms): -55 dBc in a 50 Hz to 15 kHz post-detection noise bandwidth.

Residual FM on CW (averaged rms deviation): $< 0.3 \text{ ppm}$ in a 0.3 to 3 kHz post-detection noise bandwidth; $< 0.5 \text{ ppm}$ in a 50 Hz to 15 kHz post-detection noise bandwidth.

Output Characteristics

Range: 10 dB steps and a 13 dB vernier provide power settings from +10 dBm to -130 dBm (0.7 V to 0.07 μ V) into 50 Ω . With Option 003, maximum output power is +8 dBm (0.56 V).

Impedance: 50 Ω ac coupled, SWR < 1.3 on 0.1 V range or lower. With Option 003, SWR < 1.5 on 0.1 V range or lower.

Level accuracy (total as indicated on level meter): +10 to -7 dBm , $\pm 1.5 \text{ dB}$; -7 to -57 dBm , $\pm 2.0 \text{ dB}$; -57 to -97 dBm , $\pm 2.5 \text{ dB}$; -97 to -127 dBm , $\pm 3 \text{ dB}$.

Level flatness: $\pm 1 \text{ dB}$ referenced to the output at 250 MHz for output levels $> -7 \text{ dBm}$.

Auxiliary RF output: $> -7 \text{ dBm}$ (100 mV) into 50 Ω .

Reverse power protection (option 003): protects signal generator from accidental applications of up to 25 W (+44 dBm) of RF power (between 10 and 520 MHz) into generator output.

Modulation Characteristics

Amplitude modulation: specifications apply for output power $< +3 \text{ dBm}$. AM is possible above +3 dBm as long as the combination of the AM depth plus carrier output level does not exceed +9 dBm.

Depth: 0 to 90%

Modulation rate: internal, 400 and 1000 Hz $\pm 10\%$, external 3 dB bandwidth, dc to $> 20 \text{ kHz}$.

External AM sensitivity:² $(0.1 \pm 0.01)\%$ AM/mV pk into 600 Ω .

Indicated AM accuracy:² $\pm (5\% \text{ of reading} + 5\% \text{ of full scale})$.

Peak incidental frequency deviation (30% AM):² $< 200 \text{ Hz}$.

Envelope distortion:² $< 3\%$, 0 to 70% modulation; $< 5\%$, 70 to 90% modulation.

Frequency Modulation

8654A: uncalibrated.

8654B: fully calibrated.

Peak deviation: 0 to 30 kHz from 10 to 520 MHz.

0 to 100 kHz from 80 to 520 MHz.

Deviation ranges: 0 to 3 kHz, 0 to 10 kHz, 0 to 30 kHz, 0 to 100 kHz.

Modulation rate: internal, 400 and 1000 Hz $\pm 10\%$; external 3 dB bandwidth, dc to $> 25 \text{ kHz}$.

FM distortion:² $< 2\%$ for deviations up to 30 kHz, $< 3\%$ for deviations up to 100 kHz.

External FM sensitivity (with FM vernier fully clockwise):² 1 volt peak yields maximum deviation indicated on peak deviation meter.

Sensitivity accuracy (15° to 35°C):² $\pm 12\%$. For 100 kHz deviation above 130 MHz, add 3%.

Indicated FM accuracy (15° to 35°C):² $\pm (12\% \text{ of reading} + 3\% \text{ of full scale})$. For 100 kHz deviation above 130 MHz, add 3% of reading.

Incidental AM:² $< 1\%$ AM at 30 kHz deviation.

Frequency modulation, 8654A: uncalibrated.

Deviation: $> 0.1\%$ of carrier frequency, maximum.

Modulation rate: internal, 400 & 1000 Hz $\pm 10\%$. External 3 dB bandwidth, dc coupled to $> 25 \text{ kHz}$ driven from 600 Ω or less.

External FM sensitivity: 10 V_{pk} into 600 Ω yields $> 0.1\%$ deviation ($\pm 15 \text{ volts max}$).

General Characteristics

Power: 100 or 120 volts (+5%, -10%) from 48 to 440 Hz; or 220 to 240 volts (+5%, -10%) from 48 to 66 Hz. Power consumption is 25 VA max. 2.3 m (7.5 ft.) power cable furnished with mains plug to match destination requirements.

Weight: net, 8.0 kg (17.5 lb). Shipping, 9.5 kg (21 lb).

Size: 178 H x 267 W x 306 mm D (7" x 10.5" x 12").

Ordering Information

8654A AM/FM Signal Generator

8654B AM/FM Signal Generator

Option 003: Reverse power protection (for 8654A/B)

Option 910: Extra operating and service manual

¹Specifications apply from 10 to 520 MHz for output power—+10 dBm and over the top 10 dB of output level vernier range unless otherwise specified.

²400 and 1000 Hz modulation rates.



- Stable, easy to use, 800-2400MHz, 1800-4500MHz

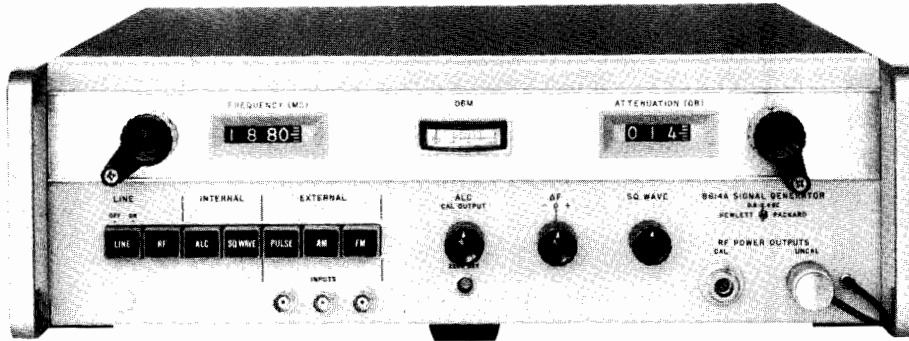

8614A

8614A, 8616A Signal Generators

The HP 8614A and 8616A Signal Generators provide stable, accurate signals from 800 to 2400 MHz (8614A) and from 1800 to 4500 MHz (8616A). Both frequency and attenuation are set on direct-reading digital dials. Selectable functions include CW, leveled output, square-wave modulation, and external AM, FM and pulse modulation. Modulation can be accomplished simultaneously with or without leveling.

Two RF power outputs are simultaneously available from separate front-panel connectors. One provides at least 10 mW (2 mW above 3000 MHz) or a leveled output from 0 to -127 dBm. The other is at least 0.5 mW across the band. This signal can be used for phase-locking the signal generators for extreme stability, or it can be monitored with a frequency counter for extreme frequency resolution without adversely affecting the primary output.

A unique PIN diode modulator permits amplitude modulation from dc to 1 MHz or RF pulses with a 2 μ s rise time. This broad modulation bandwidth permits remote control of output level or precise leveling using external equipment. The internal leveling is also obtained by using a PIN modulator.

The 8614A and 8616A can also be used with companion modulators, HP 8403A modulators and HP 8730-series PIN modulators to provide 80 dB pulse on/off ratio (see page 363). In addition, TWT amplifiers can be used with these generators to provide high power levels.

Specifications

8614A

Frequency range: direct reading within 2 MHz, 800 to 2400 MHz.
Vernier: Δ F control has a minimum range of 1.0 MHz for fine tuning.

Frequency calibration accuracy (0 dBm & below): ± 5 MHz.

Frequency stability: approximately 50 ppm/ $^{\circ}$ C change in ambient temperature, less than 2500 Hz peak residual FM; 30 ppm change for line voltage variation of $\pm 10\%$.

RF output power: +10 dBm (0.707 V) into 50 Ω load. Output attenuation dial directly calibrated in dBm from 0 to -127 dBm. A second uncalibrated output (approximately -3 dBm) is provided on front panel.

RF output power accuracy (with respect to attenuation dial): ± 0.75 dB + attenuator accuracy (0 to -127 dBm) including leveled output variations.

Attenuator accuracy: +0, -3 dB from 0 to -15 dBm; ± 0.2 dB ± 0.06 dB/10 dB from -15 to -127 dBm; direct reading dial, 0.2 dB increments.

Output impedance: 50 Ω ; SWR < 2.0.

Modulation: on-off ratio at least 20 dB for square wave, pulse.

Internal square wave: 950 to 1050 Hz. Square wave can be synchronized with a +1 to +10 V signal at PULSE input.

External pulse: 50 Hz to 50 kHz; 2 μ s rise time, +20 to +100 V peak input.

External AM: dc to 1 MHz.

External FM: front-panel connector capacity-coupled to repeller of klystron; four-terminal rear-panel connector (Cinch-Jones type S304AB) is dc-coupled to repeller of klystron.

Power source: 115 or 230 V $\pm 10\%$, 50 to 60 Hz, approximately 130 W.

Size: cabinet, 141 H x 425 W x 467 mm D (5.5" x 16.75" x 18.4"); rack mount, 133 H x 416 W x 483 mm D (5.2" x 16.4" x 19").

Weight: net, 19.5 kg (43 lb). Shipping, 22.7 kg (50 lb).

Accessory furnished: 11500A Cable Assembly.

8616A

Frequency range: direct reading within 2 MHz, 1800 to 4500 MHz.
Vernier: Δ F control has a minimum range of 1.0 MHz for fine tuning.

Frequency calibration accuracy (0 dBm & below): ± 10 MHz.

Frequency stability: approximately 50 ppm/ $^{\circ}$ C change in ambient temperature, less than 2500 Hz peak residual FM; 30 ppm change for line voltage variation of $\pm 10\%$.

RF output power: +10 dBm (0.707 V) to -127 dBm into 50 Ω load, 1800 to 3000 MHz; +3 dBm to -127 dBm from 3000 to 4500 MHz into a 50 Ω load. Output attenuation dial directly calibrated in dBm from 0 to -127 dBm. A second uncalibrated output (approximately -3 dBm) is provided on the front panel.

RF output power accuracy (with respect to attenuation dial): ± 1.0 dB + attenuator accuracy (0 to -127 dBm).

Attenuator accuracy: +1, -2 dB from 0 to -10 dBm; ± 0.2 dB ± 0.06 dB/10 dB from -10 to -127 dBm.

Output impedance: 50 Ω ; SWR < 2.0.

Modulation: on-off ratio at least 20 dB for square wave, pulse.

Internal square wave: 950 to 1050 Hz. Other frequencies available on special order.

External pulse: 50 Hz to 50 kHz; 2 μ s rise time, +20 to +100 V peak input.

External AM: dc to 1 MHz.

External FM: front panel connector capacity-coupled to repeller of klystron; four-terminal rear panel connector (Cinch-Jones type S304AB) is dc-coupled to repeller of klystron.

Power source: 115 or 230 V $\pm 10\%$, 50 to 60 Hz, approximately 130 W.

Size: cabinet, 141 H x 425 W x 467 mm D (5.5" x 16.75" x 18.4"); rack mount, 133 H x 416 W x 483 mm D (5.2" x 16.4" x 19").

Weight: net, 19.5 kg (43 lb). Shipping, 22.7 kg (50 lb).

Accessory furnished: 11500A Cable Assembly

Ordering Information

8614A Signal Generator (800-2400 MHz)

8616A Signal Generator (1800-4500 MHz)

8614A and 8616A Options

Option 001: External modulation input connectors on rear panel in parallel with front-panel connectors; RF connectors on rear panel only.

Option 908: Rack mounting flange kit

Option 910: Extra operating and service manual



SIGNAL GENERATORS

Solid-State Microwave Signal Generators

Models 8683/8684A,B,D

- New models with broader capability
- Wider frequency coverage;
2.3–13 GHz and 5.4–18 GHz



- Wideband FM for Satellite Video
± 10 MHz peak deviation
dc–10 MHz rates



8683D/8684D Microwave Signal Generators

The new 8683D and 8684D additions to the 8683/84 Signal Generator family offer broader frequency coverage with wide deviation FM modulation. Using built-in frequency doublers, the "D" models double the frequency range available in the radar/communication "B" models.

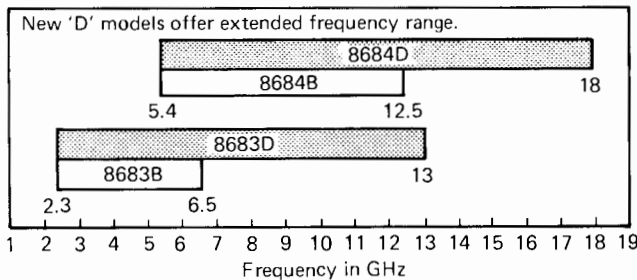

In doubler mode (selected with the simple push of a button), the signal generator's microprocessor correctly displays doubled output frequency and FM deviation, and compensates for internal component frequency variation and selected cable offset.

8683D/8684D Specifications

In the fundamental frequency band (8683D, 2.3–6.5 GHz; 8684D, 5.4–12.5 GHz) all specifications are identical to 8683B and 8684B specifications. In the doubled frequency band (8683D, 6.5–13 GHz; 8684D, 12.5–18 GHz) the following specifications apply:

	8683D		8684D	
	Fundamental	Doubled	Fundamental	Doubled
Frequency Range	2.3–6.5 GHz	6.5–13 GHz	5.4–12.5 GHz	12.5–18 GHz ¹
Output Range	+10 to -130 dBm	-3 to -130 dBm ²	+10 to -130 dBm	-3 to -130 dBm ²

¹ 8684D operates to 25 GHz but is specified only to 18 GHz

² +10 dBm maximum output power available with Opt 001

Fundamental feedthrough: < -30 dBc

Amplitude modulation: unchanged in doubled band

Frequency Modulation

Peak deviation: ± 10 MHz.

Rates: dc to 10 MHz.

Pulse modulation: unchanged in doubled band

Ordering Information

8683D Microwave Signal Generator

8684D Microwave Signal Generator

Option 001: +10 dBm output power
in doubled band.

Option 003: 400 Hz line frequency

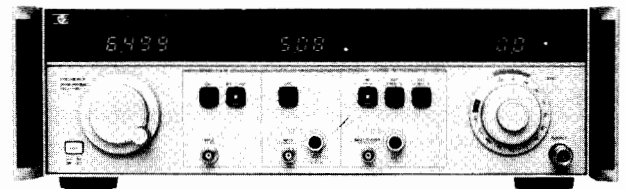

8683/8684 Microwave Signal Generators

The 8683 and 8684 are rugged, portable signal generators which provide similar capabilities in two overlapping frequency ranges. Each is available as a communications version (8683/84A) or a more versatile radar/communications version (8683/84B).

Freq. Band	Communication Appl.	Radar/Commun. Appl.
2.3–6.5 GHz	8683A	8683B
5.4–12.5 GHz	8684A	8684B

The "B" versions differ from the "A" versions by offering higher maximum leveled output power and high performance pulse modulation with an internal pulse generator.

Clean, Stable Cavity-Tuned Oscillator

At the heart of the signal generators is their mechanically-tuned cavity oscillators. The oscillators are the result of coupling state-of-the-art electronics with sophisticated mechanical design and precision manufacturing techniques. Mechanical cavity-tuning is chosen for its excellent frequency stability and spectral purity. The oscillators' active elements (bipolar transistors in the 8683 and GaAs FET's in the 8684) help attain the very low residual FM and spurious response specifications of the generators.

Microprocessor Enhances Measurement Accuracy

A microprocessor has been incorporated into the design of these manually-tuned generators. Characteristics of microwave components such as oscillators, amplifiers, and attenuators vary considerably with frequency and power level. The microprocessor provides an effective and economical means for this compensation.

The microprocessor also makes possible convenience features such as displaying output level in absolute dBm, dB relative to a user-selected power level, or with a specified Cable Offset. When Cable Offset is selected, the output level display indicates the power level at the end of a user-selected length of RG-214/U cable rather than the level at the generator's output connector.



Capabilities for Specific Microwave Measurements

The 8683 and 8684 were designed to meet the requirements of major microwave systems applications. In making out-of-channel communications receiver measurements, wide frequency range, low spurious, and a low noise floor are imperative. Receiver sensitivity measurements require excellent signal generator performance at low signal levels. These performance features are built into the 8683 and 8684. In addition, convenience features such as Cable Offset can significantly enhance overall measurement accuracy.

The features included in the "B" models provide the capability to handle advanced radar applications. With the addition of the high performance pulse modulator and internal pulse generator, simulation of a wide variety of radar transmissions is possible. Simultaneous FM and pulse allow chirping, while simultaneous AM and pulse allow simulation of antenna scan patterns. Of course, basic receiver sensitivity and AGC measurements can easily be made.

Reliability and Serviceability

The 8683 and 8684 were designed with reliability and serviceability as major considerations. The instruments were type tested to rigorous military specifications (MIL-T-28800 Class IV) for operating and non-operating temperature, humidity, condensation, shock and vibration, and EMI. The instruments' success in these tests is an indication of their ruggedness. Confidence that a desired output signal has been accurately generated is derived, in part, from a diagnostic test which is automatically executed on turn-on. These tests monitor most critical circuit nodes within the generator locating possible problem areas prior to the generator entering its operating mode. Reliability is further enhanced with optional reverse power protection.

Excellent serviceability results from the combination of accessibility to components, completeness of service manuals, and internal diagnostic capability. In the diagnostic mode, failures can be isolated to at least circuit function level with the aid of the front panel display or a computer terminal.

8683A/B, 8684A/B Specifications

Frequency Characteristics

Range: 8683, 2.3–6.5 GHz; 8684, 5.4–12.5 GHz.

Resolution: 8683, 5 MHz using a 4 digit LED display; 8684, 10 MHz using a 3½ digit LED display.

Calibration accuracy: 8683, $\pm 1.25\%$ ≤ 4 GHz, $\pm 0.75\%$ > 4 GHz;

8684, $\pm 1.25\%$ < 9 GHz, $\pm 0.75\%$ > 9 GHz.

Stability (typical)

vs. time (20 min. after turn-on): < 30 kHz/min.

vs. time (60 min. after turn-on): < 100 kHz/hr.

vs. temperature (0 to 55°C): 8683, < 15 MHz; 8684, < 30 MHz.

vs. line voltage (transients of $\pm 5\%$ – 10%): < 20 ppm.

Spectral Purity

Harmonics (< 18 GHz, at specified max output): < -25 dBc.

Spurious (non-harmonically related): < -80 dBc; typ, < -90 dBc.

Residual FM (50 Hz to 15 kHz post detection BW): < 5 kHz peak.

Single-sideband phase noise (avg. rms, 1 Hz BW, 10 kHz offset from carrier, typical): 8683, < -72 dBc; 8684, < -65 dBc.

Residual AM (avg. rms, 300 Hz to 15 kHz post det. BW): $< 0.1\%$.

Output Characteristics

Range (leveled into 50 Ω): 8683/84A, 0 to -130 dBm; 8683/84A opt. 001 and 8683/84B, $+10$ to -130 dBm.

Resolution: 0.1 dB using a 3½ digit LED display.

Accuracy: ± 2.5 dB from maximum specified output to -110 dBm; ± 3.5 dB from -110 to -120 dBm. Typ. $< \pm 0.9$ dB at -110 dBm option 002 affects level accuracy $< \pm 0.5$ dB.

Flatness (power level > -10 dBm): ± 1.0 dB.

Reverse power protection: the generators typically accept 1 watt avg. or 100 watts peak power with no damage resulting. Option 002 increases this protection to 10 watts avg. or 2 kW peak.

Auxiliary output: rear panel, typically > -15 dBm into 50 Ω , prior to AM or pulse modulation; source impedance approx. 50 Ω .

Modulation Characteristics

Types: internal and external AM, FM, and Pulse (8683/84B only) Simultaneous AM, FM, Pulse.

Metering: 3-digit LED, selectable for % AM or FM deviation.

Amplitude Modulation

Depth (1 kHz rate): 0–70%.

Rates (3 dB BW at 40% depth): dc to 10 kHz (dc coupled); 50 Hz to 10 kHz (ac coupled).

Distortion (THD): $< 5\%$ at 40% depth and 1 kHz rate.

Indicated AM accuracy (depth $\leq 50\%$, 15 kHz rate): $\pm 5\%$ of f.s.

Incidental FM (30% AM depth): < 15 kHz peak to peak.

Internal AM: fixed 1 kHz nom. square wave with $50 \pm 5\%$ duty cycle.

Frequency Modulation

Peak deviation: ± 5 MHz.

Rates (3 dB BW): dc to 10 MHz, 100 Hz to 10 MHz (ac coupled).

Distortion: $< 5\%$ at 100 kHz rate and < 1 MHz peak deviation.

Indicated accuracy (typ., 10 MHz/V range): $\pm 10\%$ of full scale, deviations < 5 MHz, 100 kHz rate.

Incidental AM (rate < 100 kHz, peak deviation < 1 MHz): $< 6\%$.

Internal FM: FM sawtooth with a fixed sweep rate of 1 kHz nom. and variable deviation up to ± 5 MHz.

Phase lock input: typical sensitivity of -5 MHz/V.

Pulse Modulation

8683/84B Internal Pulse Generator

Rate: 10 Hz to 1 MHz continuously adjustable in 5 ranges.

Width: 50 ns to 100 ms continuously adjustable in 7 ranges.

Delay (time between sync out and video out): < 50 ns to 100 ms in 7 ranges with continuous adjustment within ranges.

Accuracy: calibration accuracy is 20% of full scale.

8683/84B External Pulse Input Requirements

Rate: 0 to 1 MHz.

Width: > 100 ns.

Level: on $> +1.0$ V peak; off $< +0.4$ V peak.

8683/84B RF Pulse Characteristics

Rise/fall time: < 10 ns.

On/off ratio: > 80 dB.

Minimum pulse width: < 100 ns.

Maximum pulse repetition frequency: > 1 MHz.

Peak pulse power: ± 0.5 dB of level set in CW mode.

General

Operating temperature range: 0° to 55°C.

EMI: MIL-STD-461, VDE0871, CISPR Pub. 11.

Environmental (operating and non-operating temperature, humidity, shock and vibration): type tested to MIL-T-28800B Class IV requirements.

Safety: meets the requirements of IEC 348.

Power: 100, 120, 220, or 240, $\pm 5\%$, -10% ; 48 to 66 Hz; (Opt. 003 adds 400 Hz operation at 100 or 120 V); < 200 VA max.

Dimensions: 145 H x 457 W x 472 mm D (5.7" x 18" x 18.6").

Weight: 8683, 17.3 kg (38 lbs.) net, 22.8 kg (50 lbs.) shipping; 8684, 15.9 kg (35 lbs.) net, 21.4 kg (47 lbs.) shipping.

Ordering Information

8683A Microwave Signal Generator

8684A Microwave Signal Generator

8683B Microwave Signal Generator

8684B Microwave Signal Generator

Option 001: $+10$ dBm output power, 8683A, 8684A

Option 002: Reverse power protection

Option 003: 400 Hz line frequency operation

Option 910: Extra operating and service manual

Option 913: Rack mounting flange kit

SIGNAL GENERATORS

Synthesized Signal Generators

Models 8673B, 8672A

- 2 to 26.5 GHz frequency range
- 1 to 4 kHz frequency resolution
- Low spurious and phase noise

- +8 to -100 dBm calibrated output
- Internally leveled pulse modulation
- Metered AM/FM

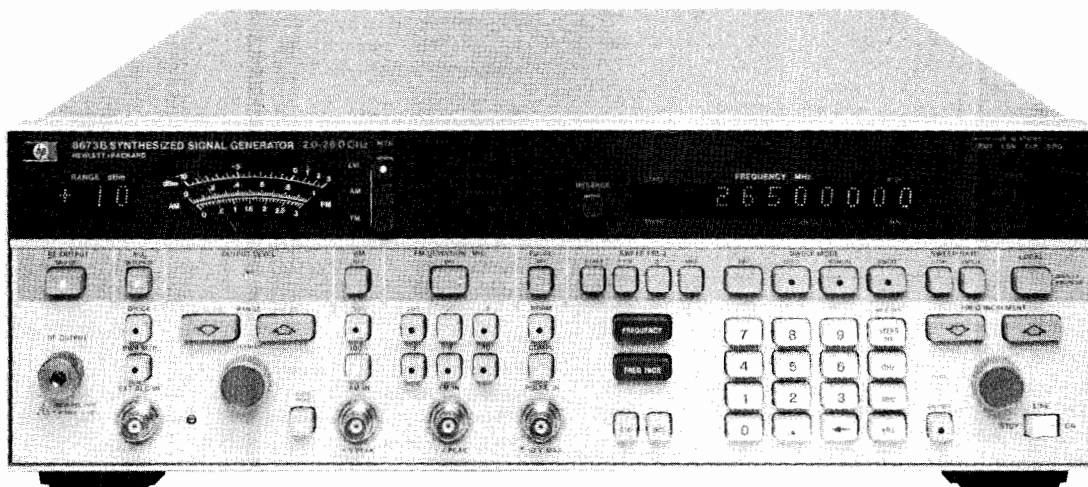

8673B



8673B, 8672A Synthesized Signal Generators

The 8673B and established 8672A Synthesized Signal Generators deliver precise microwave signals over the 2.0 to 26.0 GHz and 2.0 to 18.0 GHz frequency ranges respectively. The generators feature a compact solid-state package (133mm, 5.25 in. high), calibrated and leveled output power, AM/FM modulation capability, and full programmability. The 8673B further features internally leveled pulse modulation and microprocessor-enhanced control facilitating digital sweep.

Excellent Spectral Purity

For LO applications and many tests on radar and microwave communication systems, the 8672A and 8673B provide extremely stable frequencies. Output signals are derived by multiplying a fundamental 2.0 to 6.6 GHz - 1 kHz resolution YIG-tuned oscillator $\times 1$, $\times 2$, $\times 3$, or $\times 4$ to yield resolutions of 1 to 4 kHz depending upon band of operation. Indirect synthesis phase-locks the YIG-tuned oscillator to a 10 MHz quartz crystal reference providing excellent long and short term stability (frequency drift $< 5 \times 10^{-10}$ per day). Phase-locked loop responses are optimized to allow the 8672A/73B generators to exhibit the lowest possible single-sideband phase noise.

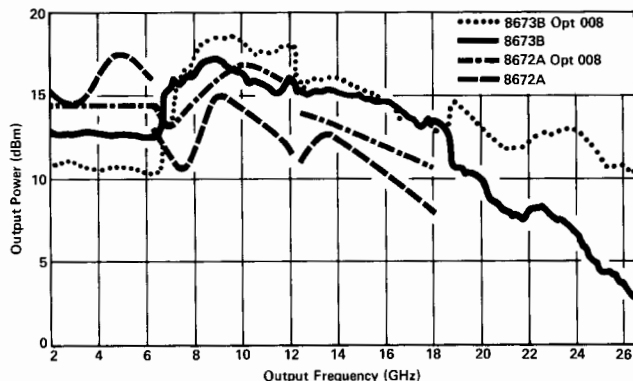

Figure 1. Maximum power typically available from 8673B, 8673B Option 008, 8672A, and 8672A Option 008 instruments at 25°C.

Wide Dynamic Output Range

For broadband component and receiver testing applications, the 8673B and 8672A deliver exceptionally flat power outputs across their full frequency ranges. For receiver sensitivity measurements, power is internally (or externally) leveled and calibrated to -120 dBm on the 8672A and to -100 dBm on the 8673B. Maximum available power varies with frequency as shown in Figure 1. The 8672A Option 008 raises the guaranteed 8672A maximum output to +8 dBm from a standard +3 dBm. 8673B output power is guaranteed to be at least +8 dBm up to 18 GHz and 0 dBm up to 26 GHz (+7 dBm with option 008).

Internally Leveled Pulse Modulation

The 8673B features an internal pulse modulator that provides high-quality pulse modulation over the entire 2.0 to 26.0 GHz range. The modulation is done before the frequency multiplication allowing the peak pulsed power to be leveled and calibrated to within ± 1 dB of the set level referenced to CW. ON/OFF ratios > 80 dB and rise/fall times < 35 ns make the 8673B ideal for use in pulsed radar test systems. Externally supplied TTL level drive signals determine pulse rates up to 1 MHz and leveled pulse widths as narrow as 100 ns.

Calibrated AM/FM Modulation

To expand the versatility of the 8672A and 8673B in receiver testing applications, AM/FM capability is included. AM depth at rates up to 100 kHz can be accurately set using the front panel meter. Six ranges of metered FM are available at rates and peak deviations up to 10 MHz. Both AM depth and FM deviation are linearly controlled by varying the externally supplied modulating input voltage up to 1 V peak.

Full Programmability and Digital Sweep

The 8673B and 8672A both provide full programmability of all front-panel functions for automatic test system applications. Over HP-IB, output level can be controlled in steps as fine as 1 dB (8672A) and 0.1 dB (8673B). In addition, the 8673B uses an internal microprocessor that facilitates convenient keyboard control, easy HP-IB program code generation following front-panel keystroke sequences, and digital sweep. Sweep spans can be set over the entire frequency range with variable rates, step sizes, and selectable markers available. Sweep outputs needed for compatibility with scalar and network analyzers are provided on the 8673B rear panel.

- 2 to 18 GHz frequency range
- Low spurious and phase noise
- Metered AM/FM

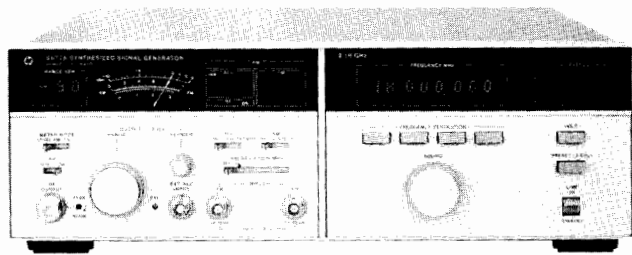

8672A

8672A, 8673B Specifications

(8672A and 8673B specifications are identical except for additional 8673B specifications *in italic type*.)

Frequency Characteristics

- Frequency range:** 2.0–18.0 GHz (18.599997 GHz overrange).
2.0–26.0 GHz (26.5 GHz overrange).
- Frequency bands:** band 1, 2.0–6.2 GHz; *2.0–6.6 GHz*
band 2, 6.2–12.4 GHz; *6.6–12.3 GHz*
band 3, 12.4–18.0 GHz; *12.3–18.6 GHz*
band 4, *18.6–26.0 GHz*.

Frequency resolution: 1 kHz in Band 1, 2 kHz in Band 2, 3 kHz in Band 3, *4 kHz in Band 4.*

Time base: internal 10 MHz ($<5 \times 10^{-10}$ /day aging rate) or external 5 or 10 MHz.

Frequency switching time: <15 ms (<20 ms) to be within specified resolution, all bands.

Spectral Purity

Single-Sideband Phase Noise (1 Hz BW, CW mode)

F _c	Offset from F _c				
	10 Hz	100 Hz	1 kHz	10 kHz	100 kHz
Band 1	-58 dBc	-70 dBc	-78 dBc	-86 dBc	-110 dBc
Band 2	-52 dBc	-64 dBc	-72 dBc	-80 dBc	-104 dBc
Band 3	-48 dBc	-60 dBc	-68 dBc	-76 dBc	-100 dBc
Band 4	-46 dBc	-58 dBc	-66 dBc	-74 dBc	-98 dBc

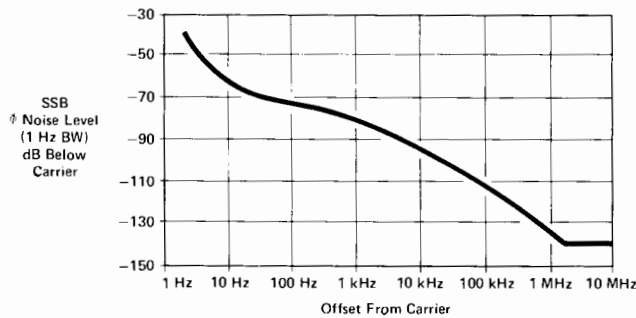

Figure 2. Typical 8672A & 8673B single-sideband phase noise performance using the internal standard, Band 1.

Harmonics (up to maximum frequency, output level meter readings <0 dB on 0 dBm range and below): <-25 dBc, <-40 dBc.

Sub-harmonics and multiples thereof: <-25 dBc, Bands 1–3;
 <-20 dBc, Band 4.

Spurious (CW and AM modes)

Non-harmonically related: <-70 dBc, Band 1; <-64 dBc, Band 2; <-60 dBc, Band 3; <-58 dBc, Band 4.

Power Line Related and Fan Rotation Related Within 5 Hz Below Line Frequency and Multiples Thereof

F _c	Offset from F _c		
	<300 Hz	300 Hz to 1 kHz	>1 kHz
Band 1	-50 dBc	-60 dBc	-65 dBc
Band 2	-44 dBc	-54 dBc	-59 dBc
Band 3	-40 dBc	-50 dBc	-55 dBc
Band 4	-38 dBc	-48 dBc	-53 dBc

Output Characteristics

Output level (+15°C to +35°C): +3 to -120 dBm; +8 to -100 dBm up to 18 GHz, +4 to -100 dBm up to 22 GHz, 0 to -100 dBm up to 26 GHz.

Flatness (0 dBm range, +15°C to +35°C): ± 0.75 dB through Band 1, ± 1.0 dB through Band 2, ± 1.25 dB through Band 3, ± 1.75 dB through Band 4.

Remote programming output level resolution: 1.0 dB; 0.1 dB.

Source impedance: 50 ohms nominal.

Pulse Modulation

ON/OFF ratio: >80 dB.

Rise/fall times: <35 ns.

Minimum leveled pulse width: <100 ns.

Pulse repetition frequency: dc–1 MHz.

Maximum peak power: same as in CW mode.

Peak level accuracy (relative to CW, +15°C to +35°C): ± 1 dB.

Pulse modulation input requirements: normal mode, positive-true TTL levels; complement mode, negative-true TTL levels.

Video feedthrough: typically <-50 dBc.

Amplitude Modulation

Rates (3 dB BW, 30% depth): 10 Hz–100 kHz; 10 Hz–50 kHz (Option 008); 20 Hz–100 kHz.

Sensitivity: 30%/V, 100%/V ranges. Max. input 1 V peak into 600 Ω .

Frequency Modulation

Peak deviation (max.): the smaller of 10 MHz or $f_{mod} \times 5$, Band 1; 10 MHz or $f_{mod} \times 10$, Band 2; 10 MHz or $f_{mod} \times 15$, Band 3; 10 MHz or $f_{mod} \times 20$, Band 4.

Sensitivity: 30, 100, 300 kHz/V and 1, 3, 10 MHz/V ranges.

Max. input 1 V peak into 50 Ω .

Rates (3 dB BW typical): 30, 100 kHz/V ranges: 50 Hz to 10 MHz; 300 kHz/V and 1, 3, 10 MHz/V ranges: 1 kHz to 10 MHz.

Digital Sweep Characteristics.

Sweep function: start/stop or ΔF (span) sweep.

Sweep modes: manual, auto, or single sweep.

Step size: maximum of 9999 frequency points per sweep; minimum step size equals frequency resolution.

Dwell time: set from 1 to 255 ms per frequency.

Markers: 5 independent, settable frequency markers.

Sweep outputs: 0 to +10 V ramp start to stop; 1 V/GHz ramp (18 V maximum); Z-axis blanking/markers; tone marker; penlift.

Remote Programming

All functions HP-IB programmable with the exception of line switch. The 8673B can output over the interface frequency and output level settings, error/malfunction codes, and operational status codes.

General

Operating temperature range: 0°C to +55°C.

Power: 100, 120, 220, 240 V, +5%, -10%, 48–66 Hz; 400 VA max.

Weight: net, 27 kg (60 lb), 29 kg (64 lb). Shipping, 32.5 kg (72 lb), 34.3 kg (76 lb).

Size: 133 mm H x 425 mm W x 603 mm D (5.25" x 16.75" x 23.75").

Ordering Information

8673B Synthesized Signal Generator

8672A Synthesized Signal Generator

Option 001: Delete RF output attenuator

Option 002: Delete reference oscillator

Option 003: Operation at 400 Hz line

Option 004: Rear panel RF output

Option 005: Rear panel RF output without RF attenuator

Option 006: Chassis slide kit

Option 008: +8 dBm (+7 dBm) output level

Option 907: Front panel handle kit

Option 908: Rack mounting flange kit

Option 909: Front panel handle kit plus rack mounting flange kit

Option 910: Extra operating and service manual

11712A Support Kit (for 8672A)

11726A Support Kit (for 8673B)

SIGNAL GENERATORS

Synthesized Signal Generators

Models 8673C and 8673D

- 10 MHz to 26.5 GHz frequency range
- < -60 dBc harmonics/subharmonics
- Low SSB phase noise and spurious outputs
- $+5$ to -100 dBm calibrated output
- 1 to 4 kHz frequency resolution
- Leveled pulse modulation/AM/FM



8673D

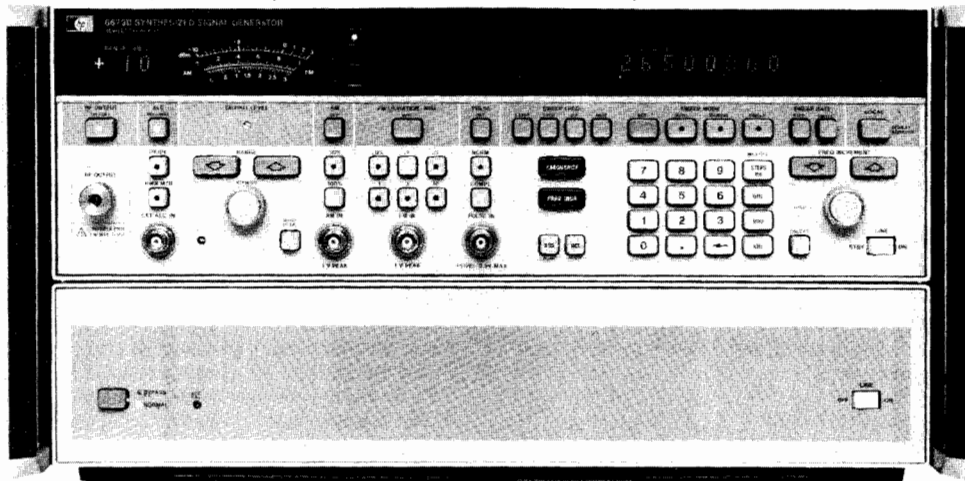

8673C and 8673D Synthesized Signal Generators

Designed as versatile microwave test sources for broadband receiving systems, the 8673C and 8673D Synthesized Signal Generators offer precise signal simulation capability in the 50 MHz to 26.5 GHz frequency range. The generators deliver spectrally pure frequencies, with harmonically related spurious outputs < -60 dBc above 1.2 GHz. Internal solid state amplifiers guarantee that adequate levels will be delivered to the system under test, even after the signal has passed through a number of automatic test system switching paths. Output is leveled and calibrated to a low level of -100 dBm, and maximum leveled output is specified to be at least $+5$ dBm across the 8673D operating band. High performance pulse modulation (> 80 dB ON/OFF ratios, < 40 ns rise/fall times) is delivered via external video modulating signals, as are amplitude and frequency modulation. Simultaneous modulation is possible to simulate complex environments. All operating parameters are HP-IB programmable.

For source applications limited to Ku band and below, the 8673C offers 50 MHz to 18.6 GHz frequency coverage, with $+5$ dBm levels to 16 GHz, and $+2$ dBm to 18.6 GHz.

The 8673C and 8673D are built around the highly reliable 8673A and 8673B Synthesized Signal Generators. Field 8673A and 8673B units can be retrofitted into the 8673D configuration.

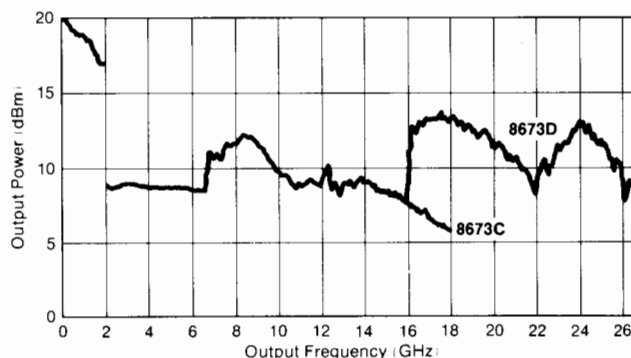

Figure 1. Maximum power typically available from the 8673C and 8673D at 25°C

8673C and 8673D Specifications

(8673C and D specifications are identical to 8673B specifications with the following exceptions and/or additions.)

Frequency Characteristics

Frequency range

8673D: 50 MHz–26.0 GHz (10 MHz–26.5 GHz overrange);

8673C: 50 MHz–18.6 GHz (10 MHz–18.6 GHz overrange).

Frequency bands: band 0, 50 MHz–2.0 GHz

Frequency resolution: 1 kHz in Band 0

Frequency switching time: < 50 ms to be within specified resolution, all bands.

Spectral Purity

Single-Sideband Phase Noise (1 Hz BW, CW mode)

F _C	Offset from F _C				
	30 Hz	100 Hz	1 kHz	10 kHz	100 kHz
Band 0	-64 dBc	-70 dBc	-78 dBc	-86 dBc	-110 dBc

Harmonics (up to maximum frequency, output level meter readings < 0 dB on 0 dBm range and below): < -40 dBc, 50 MHz–1.2 GHz; < -60 dBc, 1.2–26.0 GHz

Subharmonics and multiples thereof: < -60 dBc

Spurious (CW and AM modes)

Non-harmonically related: < -60 dBc, Band 0

Power line related and fan rotation related within 5 Hz below line frequency and multiples thereof:

F _C	Offset from F _C		
	< 300 Hz	300 Hz to 1 kHz	> 1 kHz
Band 0	-50 dBc	-60 dBc	-65 dBc

Output Characteristics

Output level ($+15^\circ\text{C}$ to $+35^\circ\text{C}$): $+11$ to -100 dBm, 50 MHz to 2 GHz; $+5$ to -100 dBm, 2 to 16 GHz; $+6$ to -100 dBm, 16–26 GHz ($+2$ to -100 dBm, 8673C 16–18.6 GHz).

Flatness (0 dBm range, $+15^\circ\text{C}$ to $+35^\circ\text{C}$): ± 0.5 dB through Band 0.

Pulse Modulation

Rise/fall times: < 15 ns, Band 0.

Frequency Modulation

Peak deviation (max.): the smaller of 10 MHz or $f_{\text{mod}} \times 5$, Band 0.

General

Power: 100, 120, 220, 240V, $+5\%$, -10% , 48–66 Hz; 500 VA max.

Weight: net, 42.3 kg. (94 lbs). Shipping, 46.3 kg. (103 lbs.)

Size: 613 mm D x 425 mm W x 234 mm H (24.1" x 16.8" x 9.2")

Ordering Information

8673C Synthesized Signal Generator

8673D Synthesized Signal Generator

Option 001: Delete RF output attenuator

Option 002: Delete reference oscillator

Option 003: Operation at 400 Hz line

Option 004: Rear panel RF output

Option 005: Rear panel RF output without RF attenuator

Option 006: Chassis slide kit

Option 908: Rack mounting flange kit

Option 913: Rack flanges for standard front panel handles

Option 910: Extra operating and service manual



- 10 MHz–18 GHz frequency range
- Internal pulse modulator
- HP-IB programmability

- 2–6.2 GHz frequency range
- Low spurious and phase noise
- +8 dBm minimum output power

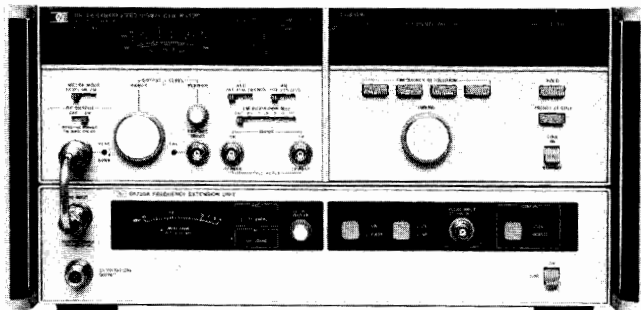

8672S

8672S Synthesized Signal Generator

The 8672S Synthesized Signal Generator consists of an 8672A Synthesized Signal Generator and an 86720A Frequency Extension Unit. The 86720A uses a heterodyne technique to extend the frequency coverage of a standard 8672A to a lower limit of 10 MHz. As a single 9-inch high package, the 8672S features 10 MHz to 18 GHz single-knob continuous frequency tuning, calibrated CW output power, and an internal pulse modulator allowing high-quality pulse modulation over the entire 10 MHz to 18 GHz frequency range. All front-panel functions, with the exception of the line switches, are HP-IB programmable.

Specifications for the 8672S are identical to those of a stand-alone 8672A for the 2 to 18 GHz frequency range with the exception of a 1 dB decrease in maximum output power and no AM modulation available below 2 GHz.

Existing 8672A signal generators can be retrofitted to the 8672S configuration by ordering the 86720A Frequency Extension Unit and an 11731A or 11732A Frequency Extension Retrofit Kit.

8672S Specifications

(Specifications for the 8672S are identical to those of the standard 8672A with the following exceptions.)

Frequency Characteristics

Frequency range: 10 MHz–18.0 GHz (18.599997 GHz overrange).
Frequency range: 1 kHz to 6.2 GHz, 2 kHz to 12.4 GHz, 3 kHz to 18.0 GHz.

Non-harmonic spurious: < -60 dBc, 10 MHz–1.999999 GHz.

Power line and fan rotation related spurious: 10 MHz–6.2 GHz, same as 8672A 2.0–6.2 GHz.

Single-sideband phase noise (1 Hz BW, CW mode): 10 MHz–6.2 GHz, same as 8672A 2.0–6.2 GHz.

Output Characteristics

Output level: +13 dBm to -120 dBm, 0.01–2.0 GHz; +2 dBm (+7 dBm, Opt. 008) to -120 dBm, 2.0–18.0 GHz.

Total indicated meter accuracy: 0.01–2.0 GHz, same as 8672A 2–6.2 GHz degraded by 0.5 dB; 2.0–18.0 GHz, 8672A degrades by 0.25 dB.

Level flatness: same as 8672A degraded by ± 0.25 dB

Modulation Characteristics

Frequency modulation: 0.01–2.0 GHz, same as 8672A 2–6.2 GHz.

Pulse modulation: > 80 dB ON/OFF ratio; < 15 ns rise/fall times; peak pulsed power within 1.0 dB of level selected in CW mode for 0.01–2 GHz, uncalibrated for 2.0–18.0 GHz.

General

Programming: all functions HP-IB programmable except line switches and meter mode.

Operating temperature range: 0 to +55°C (+15 to +35°C for specified performance).

Size: 222 H x 425 W x 620 mm D (8.8" x 16.8" x 24.4").

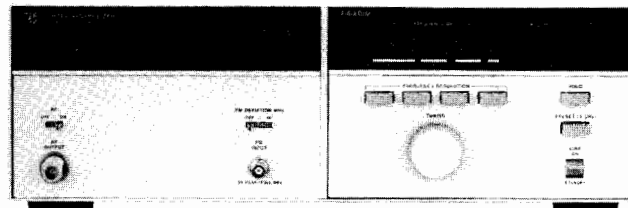

8671A

8671A Synthesizer

The 8671A microwave frequency synthesizer covers the frequency range of 2.0 to 6.2 GHz in 1 kHz steps with excellent stability and spectral purity. It is well suited for most LO applications that require state-of-the-art performance as well as broadband capability.

8671A Specifications

(Specifications for the 8671A are identical to those of the standard 8672A 2.0–6.2 GHz with the following exceptions.)

Frequency Characteristics

Harmonics: < -15 dBc.

Output Characteristics

Power (unleveled): +8 dBm (min.), +15 to +35°C.

Flatness: < 6 dB total variation across full frequency band.

Amplitude Modulation

Not available.

Frequency Modulation

Sensitivity: 50 kHz/V and 5 MHz/V ranges; max input 2 V peak.

General

Weight: net, 24 kg (53 lb). Shipping, 29.5 kg (65 lb).

Ordering Information

8672S Synthesized Signal Generator

Option 001: Delete RF output attenuator

Option 002: Delete reference oscillator

Option 003: Operation at 400 Hz line

Option 004: Rear panel RF output

Option 005: Rear panel RF output without RF attenuator.

Option 006: Chassis slide kit

Option 008: +7 dBm output level

Option 009: Delete internal pulse modulator

Option 010: Delete pulse modulator and step attenuator

Option 908: Rack flange kit

Option 913: Rack flanges for standard front panel handles.

Option 910: Extra operating and service manuals

86720A Frequency Extension Unit

11731A Frequency Extension Retrofit Kit

11732A Frequency Extension Retrofit Kit

8671A Microwave Frequency Synthesizer

Option 002: No internal reference

Option 003: Operation at 400 Hz line

Option 005: Rear panel RF output

Option 006: Chassis slide kit

Option 907: Front panel handle kit

Option 908: Rack mounting flange kit

Option 909: Front panel handle plus rack mounting flange kit

Option 910: Extra operating and service manual

11712A Support Kit

SIGNAL GENERATORS

Synthesized Sweeper

Model 8340A

- Synthesized frequencies from 10 MHz to 26.5 GHz
- 1 to 4 Hz frequency resolution
- Low spurious and phase noise
- +10 dBm to -110 dBm calibrated output
- 100 ns pulse width capability
- DC to 100 kHz amplitude modulation

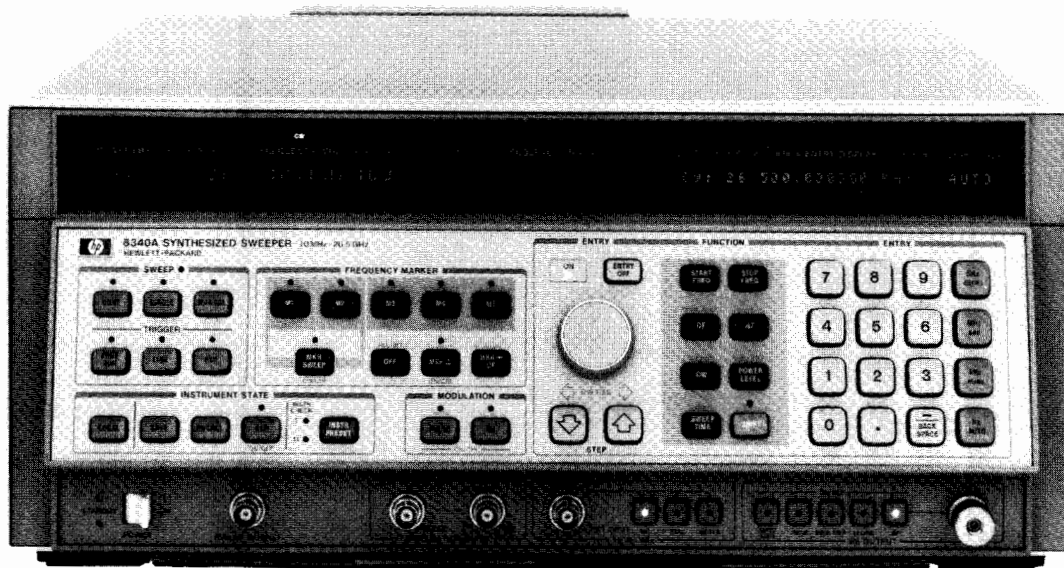

8340A



8340A Synthesized Sweeper

The 8340A Synthesized Sweeper delivers the combined high-performance of a synthesizer and a broadband sweep oscillator in one efficient instrument that is completely controllable via the Hewlett-Packard Interface Bus (HP-IB). This efficient combination of performance and versatility is ideal for manual or automatic test systems and enables the 8340A to replace a sweep oscillator, a frequency counter, an RF synthesizer, and a microwave synthesizer.

Frequency Precision and Spectral Purity

The synthesized 10 MHz to 26.5 GHz frequency coverage and the precise 1 to 4 Hz frequency resolution (depending on the frequency band) of the 8340A are generated by indirect synthesis techniques. These techniques enable the 8340A to achieve the same low single-sideband phase noise performance as the 8672A and 8673A Synthesized Signal Generators.

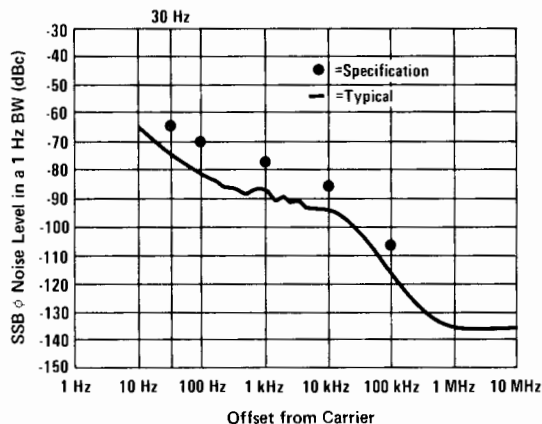

Typical 8340A Phase Noise performance from 2.3 to 7.0 GHz.

Stepped CW Switching Times

The 8340A features CW switching times of better than 50 ns (typically <35 ns). Additionally, a Fast Phase-lock programming com-

mand can be used to reduce typical CW switching times to between 11 and 22 ms (depending on frequency step size and absolute frequency value).

Output Power

The 8340A provides high output power which can be varied all the way down to the minimum level (-110 dBm) with 0.05 dB resolution. The 8340A also features power sweep capability with >20 dB dynamic range for complete characterization of level-sensitive devices.

Pulse and AM Modulation

The 8340A has a high-performance pulse modulator with an ON/OFF ratio >80 dB and rise and fall times <25 ns. Pulse amplitude is leveled and can be as narrow as 100 ns. The 8340A also features DC-coupled AM modulation with a 3 dB bandwidth of 100 kHz and a minimum depth of 90%. Pulse and amplitude modulation can be used simultaneously.

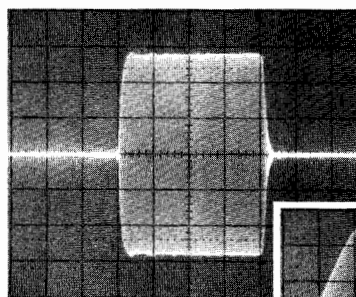

8340A Pulse Performance at 3 GHz. Pulse width=200 ns.

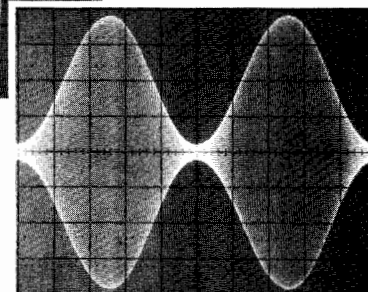

8340A AM Performance at 22 GHz. AM rate is 50 kHz and depth is 90%

For additional ordering and performance information about the 8340A, refer to page 368.

- 5 MHz to 18 GHz
- Phase noise and AM noise
- Low system noise floor

- HP-IB programmable
- Phase detector method
- Frequency discriminator method

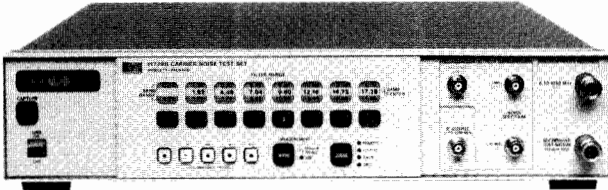

11729B

11729B Carrier Noise Test Set

Versatile Noise Measurements

Configured with an HP 8662A Synthesized Signal Generator and a spectrum analyzer, the 11729B allows versatile phase noise and AM noise characterization of microwave oscillators, 5 MHz to 18 GHz. With one convenient package, direct AM noise measurements and two methods of phase noise measurements can be made, at offsets of 1 Hz to 10 MHz from the carrier. These three methods allow a wide variety of sources, from low noise stabilized sources to free-running sources with high drift, to be measured. The 11729B may be ordered with either full frequency coverage, or in a number of dual band configurations to better match a given application.

Low Noise Performance

The 11729B offers a low system noise floor, allowing measurement of most state-of-the-art microwave oscillators. Typical system noise for a source at 10 GHz is less than -123 dBc/Hz at a 10 kHz offset. This low noise performance is achieved with the 8662A providing the necessary driving signals.

Two Phase Noise Measurement Methods

A choice of two phase noise measurement methods optimizes the measurement to the type of oscillator being measured. The phase detector method is ideal for stabilized sources or close to the carrier analysis. The 11729B/8662A simplifies the phase detector method by providing all the necessary circuitry, including a low noise microwave reference source, variable bandwidth phase lock loop, and low noise amplifier.

The frequency discriminator method is best suited for sources with high level, low rate phase noise such as free-running sources. The 11729B/8662A removes many of the traditional complications of frequency discriminators by allowing the discriminator to operate at a frequency less than 1.3 GHz. The 11729B contains all necessary hardware except a user-supplied external discriminator, which can be delay line, bridge or cavity type.

Full Programmability for System Integration

The fully HP-IB programmable 11729B is easily configured into manual or automatic carrier noise measurement systems with available lab spectrum analyzers (such as the HP 8566A, 8568A, 3585A, or 3582A). The 11729B is also compatible with the HP 3047A Spectrum Analyzer System for a complete software/hardware noise measurement solution. (For more system information, refer to the 11729B Product Notes.)

Abbreviated 11729B Specifications

Overall Performance

Frequency range: 5 MHz to 18 GHz
(typical overrange to 18.56 GHz)

Residual noise: (10 GHz input signal)

offset from carrier (Hz)	typical residual noise
10 Hz	-106 dBc/Hz
100 Hz	-117 dBc/Hz
1 kHz	-126 dBc/Hz
10 kHz	-132 dBc/Hz
100 kHz	-141 dBc/Hz
1 MHz	-143 dBc/Hz

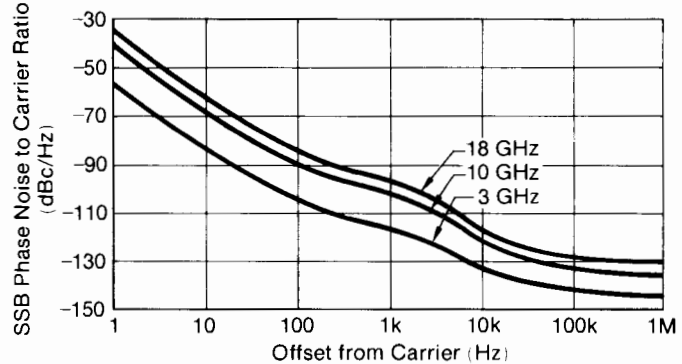

Typical System Sensitivity (when used with the 8662A)

Test Signal Requirements

Amplitude: +7 dBm minimum to +18 dBm maximum (typically useable to -15 dBm with noise floor degradation).

RF Source Requirements

8662A or 8663A Option HO3 and Option H12.

11729B Outputs

IF Output

Bandwidth: 5 to 1280 MHz

Level: +6 dBm minimum

Noise Spectrum Outputs

- 1) Auxiliary Noise Spectrum Output: dc coupled, 600 Ω nominal.
- 2) Noise Spectrum Output <1 MHz: dc coupled, 600 Ω nominal.
- 3) Noise Spectrum Output <10 MHz: 10 Hz to 10 MHz, 50 Ω nominal, nominal 40 dB of gain over <1 MHz output.

Phase Lock Loop Function

Frequency Control Outputs

To crystal oscillator: ± 10 V.

To dc FM: ± 1 V.

Lock bandwidth factor: nominal 1, 10, 100, 1k, 10k selectable.

Loop characteristics: dependent on method of phase lock chosen; typical loop bandwidths can range from 0.5 Hz to 50 kHz.

Remote Programming

All front panel functions are HP-IB programmable. In addition, the 11729B can output current settings and out-of-lock indication.

General

Operating temperature range: 0° to +55°C.

Power: 100, 120, 220, 240 V, +5%, -10%; 48 to 66 Hz; <75 VA max.

Weight: net 10.4 kg (23 lb). Shipping 13.2 kg (29 lb).

Size: 425 W x 99 H x 551 mm D (21.7 x 16.8 x 3.9 in.). 1 MW x 3 1/2 H x 20 D System II module.

Ordering Information

11729B Carrier Noise Test Set (5 MHz to 18 GHz)

Note: Each of options 003 to 027 (only one may be ordered) also includes 0.005 to 1.28 GHz coverage

Option 003 (1.28 to 3.2 GHz)

Option 007 (3.2 to 5.76 GHz)

Option 011 (5.76 to 8.32 GHz)

Option 015 (8.32 to 10.88 GHz)

Option 019 (10.88 to 13.44 GHz)

Option 023 (13.44 to 16.0 GHz)

Option 027 (16.0 to 18.0 GHz)

Option 130: AM noise detection

Option 140: Rear panel connectors

Option 907: Front panel handle kit

Option 908: Rack mounting flange kit

Option 909: Front panel handle plus rack mounting flange kit

Option 910: Extra operating and service manual

SIGNAL GENERATORS

Doublers, Pulse Modulator

Models 938A, 940A, 11720A

- Doubler sets for signal output 18-26.5 GHz, 26.5-40 GHz

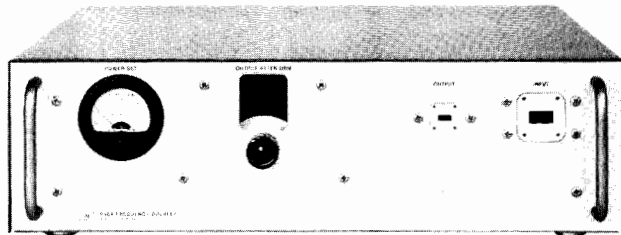

938A

938A, 940A Frequency Doubler Sets

Model 938A supplies power from 18 to 26.5 GHz and Model 940A from 26.5 to 40 GHz when driven by 9 to 13.25 GHz and 13.25 to 20 GHz sources respectively. For manually tuned frequencies, models 626A and 628A Signal Generators are ideal driving sources because of their excellent high power outputs and stable signal performance. For synthesized signal performance, the 8673B signal generator provides input signals up to 20 GHz, under programmed control. For a swept output, use a swept-frequency source such as the Model 8350B with appropriate RF units.

These frequency doubler sets consist of broadband harmonic generators suitably mounted in a waveguide section, a power monitor, a broad stopband low-pass filter, and a precision attenuator. The input signal may be CW, pulsed, or swept. Thus, the frequency doubler sets retain all the modulation versatility of the driving source.

The calibrated power monitor and precision, calibrated output attenuators allow the power output of the doubler to be calibrated even though the output of the driving source is not, and the attenuator allows output power to be accurately controlled over a range from 0 to 100 dB.

938A, 940A Specifications

Frequency range: 938A, 18 to 26.5 GHz; 940A, 26.5 to 40 GHz.

Conversion loss: less than 18 dB at 10 mW input.

Output power: approximately 0.5-1 mW when used with typical 626A, 628A signal generators; input power 100 mW maximum.

Output monitor accuracy: ± 2 dB

Output attenuator accuracy: $\pm 2\%$ of reading of ± 0.2 dB whichever is greater.

Attenuator range: 100 dB.

Output reflection coefficient: approx. 0.33 at full output; less than 0.2 with attenuator set to 10 dB or greater.

Output flange: 938A, K-band flat cover flange for WR-42 waveguide; 940A, R-band flat cover flange for WR-28 waveguide.

Input flange: 938A, M-Band flat cover flange for WR-75 waveguide; 940A, N-Band flat cover flange for WR-51 waveguide.

Accessories available: 938A, waveguide adapters MP292B, MX292B, X-band flexible waveguide 11504A, P-band flexible waveguide 11503A; 940A, waveguide adapters NP292A, MP292B, P-band flexible waveguide 11503A.

Size: 137 H x 489 W x 457 mm D (5.4" x 19.25" x 18").

Weight: net, 9 kg (20 lb). Shipping, 11.8 kg (26 lb).

- 2 to 18 GHz
- < 10 ns rise and fall times
- > 80 dB ON/OFF ratio

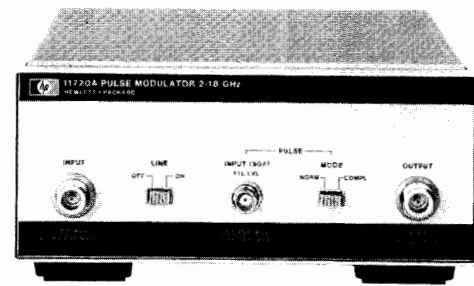

11720A

11720A Pulse Modulator

The 11720A Pulse Modulator is a high performance microwave pulse modulator covering the range of 2 to 18 GHz. Because of this wide frequency coverage, it can be used to increase the modulation capabilities of many microwave sources (sweepers or signal generators) and eliminate the need for several individual modulators in broadband applications.

The 11720A features extremely short rise and fall times (< 10 ns) and a high on/off ratio (> 80 dB), making it suitable for almost any pulsed RF application.

The 11720A contains all the necessary modulator drive circuitry to achieve specified performance so that a standard pulse generator, or any other source that can deliver > 3 V peak into 50 ohms, can supply the input. In addition, a normal/complement function is provided to adapt the 11720A to positive-true or negative-true logic inputs.

11720A Specifications

Frequency range: 2 to 18 GHz.

ON/OFF ratio: > 80 dB.

Rise and fall times: < 10 ns.

Insertion loss: < 6 dB, 2 to 12.4 GHz; < 10 dB, 2 to 18 GHz.

Maximum RF input power: +20 dBm.

Maximum repetition rate: > 5 MHz.

Minimum RF pulse width: < 50 ns.

Video feedthrough: < 60 mV peak-to-peak.

Pulse Input

Normal mode: > 3 V (on), < 0.5 V (off).

Complement mode: < 0.5 V (on), > 3 V (off).

Impedance: 50 Ω nominal.

Operating temperature: 0°C to +55°C.

Power: 100, 120, 220, 240 V +5, -10%; 48-400 Hz; 25 VA max.

Weight: net, 2.6 kg (5 lb 12 oz). Shipping, 3.6 kg (8 lb).

Size: 101 mm H x 212 mm W x 290 mm D (4.0" x 8.4" x 11.4").
1/2 MW x 3/2 H x 11 D System II Module.

Ordering Information

938A or 940A Frequency Doubler

Option 910: Extra operating & service manual

11503A Flexible Waveguide P-Band

11504A Flexible Waveguide X-Band

11720A Pulse Modulator

Option 910: Extra manual

SIGNAL GENERATORS

PIN Modulators, Pulse Driver

8730 Series, 8403A

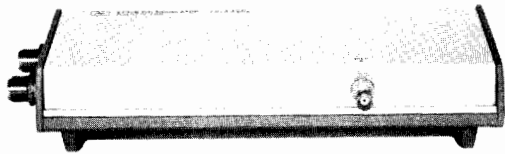

8730B Series

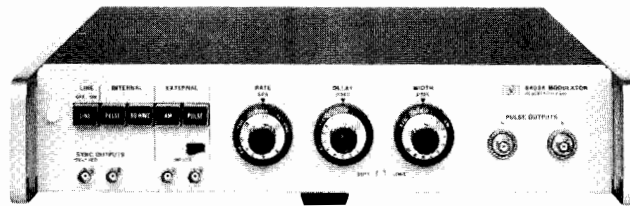

8403A

8730 Series PIN Modulators

With HP 8730 series PIN Modulators, signal sources, including klystrons, can be pulse-modulated, leveled or amplitude-modulated with sinusoidal and complex waveforms. Fast-rise times, low incidental FM and a nearly constant impedance match to source and load are typical of these absorption-type modulators.

8403A Modulator

The Model 8403A provides complete control of the PIN modulators, supplying the appropriate modulation wave shapes and bias levels for fast rise times, rated on/off ratios and amplitude modulation. An internal square-wave and pulse modulator with PRF of 50 Hz to 50 kHz and adjustable pulse width and delay also provide square wave and pulses for general pulse applications. For applications requiring an absorption-type modulator plus controls in a single unit, a PIN modulator can be installed in the Model 8403A.

8403A Specifications

Output Characteristics (available separately at front panel).

For driving 8730 PIN modulators: AM and pulse output, pulse output specially shaped for optimum RF rise and decay times.

For general pulse applications: positive dc-coupled pulse 25 to 30 volts in amplitude, approximately symmetrical about 0 volt; no AM signal.

Modulation

Internal Square Wave

Frequency: variable from 50 Hz to 50 kHz.

Symmetry: better than 45/55%.

Internal Pulse

Repetition rate: variable from 50 Hz to 50 kHz.

Delay: variable from 0.1 μ s to 100 μ s, between sync out pulse and RF output pulse.

Width: variable from 0.1 μ s to 100 μ s.

External Sync

Signal: 5 to 20 volts peak, + or -, pulse or sine wave.

Input impedance: approximately 2000 ohms, dc-coupled.

Trigger Out

Sync out: simultaneous with or 0.1 to 100 μ s in advance of RF pulse, as set by delay control.

Delayed sync out: simultaneous with output pulse.

Amplitude: approximately -2 volts.

Source impedance: approximately 330 ohms.

External Pulse

Amplitude and polarity: 5 volts to 20 volts peak, + or -.

Repetition rate: maximum average PRF, 500 kHz/s.

Input impedance: approximately 2000 ohms, dc-coupled.

Width: minimum 0.1 μ s; maximum 1/PRF - 0.4 μ s.

Amplitude Modulation (with 8730 series)

Frequency response: dc to approximately 10 MHz (3 dB).

Sensitivity: approximately 10 dB/volt with HP 8730A series; approximately 20 dB/volt with HP 8730B series.

Input impedance: approximately 1000 ohms.

General

Power: 115 or 230 volts \pm 10%, 50 to 400 Hz, approximately 10 watts.

Size: 96 H x 425 W x 467 mm D (3.75" x 16.73" x 18.4").

Weight: net, 7.4 kg (16.5 lb). Shipping, 9 kg (20 lb).

Ordering Information

8403A Modulator

Option

002: 8731B PIN Modulator installed in 8403A

004: 8732B PIN Modulator installed in 8403A

006: 8733B PIN Modulator installed in 8403A

008: 8734B PIN Modulator installed in 8403A

009: Input and Output Connectors on rear panel

908: Rack flange kit

910: Extra Manual

8730 Series Specifications

HP Model	8731B	8732B	8733B	8734B	8735B	8731B-H10 ⁶
Frequency range (GHz)	0.8-2.4	1.8-4.5	3.7-8.3	7.0-12.4	8.2-12.4	0.4-1.2
Dynamic range (dB)	80	80	80	80	80	35
Max. residual atten. (dB) ¹	<2.0	<3.5 ²	<3.0	<5.0	<5.0	<2.0
Typical rise time (ns) ³	30	30	30	30	30	40
Typical decay time (ns) ³	20	20	20	20	20	30
SWR, min. attenuation	1.6	1.6 ⁴	2.0	2.0	2.0	1.5 ⁷
SWR, max. attenuation	2.0	2.0	2.2	2.2	2.2	2.0 ⁷
Forward bias input resistance (ohms)	100	100	100	100	100	300
RF connector type	N(f)	N(f)	N(f)	N(f)	W/G ⁵	N(f)
Weight, net kg (lb)	2.5 (5.5)	2.7 (6.0)	1.4 (3.0)	1.4 (3.0)	1.4 (3.0)	2.5 (5.5)
shipping kg (lb)	3.3 (7.3)	3.5 (7.8)	1.9 (4.2)	1.9 (4.2)	1.9 (4.2)	3.3 (7.3)
Dimensions						
Height, mm (in)	57 (2.25)	57 (2.25)	57 (2.25)	57 (2.25)	57 (2.25)	57 (2.25)
Width, mm (in)	124 (4.9)	124 (4.9)	83 (3.25)	83 (3.25)	83 (3.25)	124 (4.9)
Depth, mm (in)	289 (11.4)	289 (11.4)	311 (12.3)	311 (12.3)	267 (10.5)	289 (11.4)

Maximum ratings: maximum input power, peak or CW: 1 W; bias limits: +20 V, -10 V.
Bias polarity: negative voltage increases attenuation.
RFI: radiated leakage limits are below those specified in MIL-I-6181D at input levels <1 mW; at all input levels radiated interference is sufficiently low to obtain rated attenuation.

1. With +5 V bias.
2. 4 dB, 4 to 4.5 GHz.
3. Driven by HP 8403A Modulator.
4. 2.0 SWR, 4 to 4.5 GHz.

5. Fits 1 x 1/2 in. (WR 90) waveguide.
6. External high-pass filters required.
7. Excluding high-pass filters.

SIGNAL GENERATORS

Accessories, Frequency Doublers

Models 10514A, 10534A, 11509A, 11687A, 11690A, 11697A,B,C, 11710B, 11721A

- Additional capabilities for signal generators

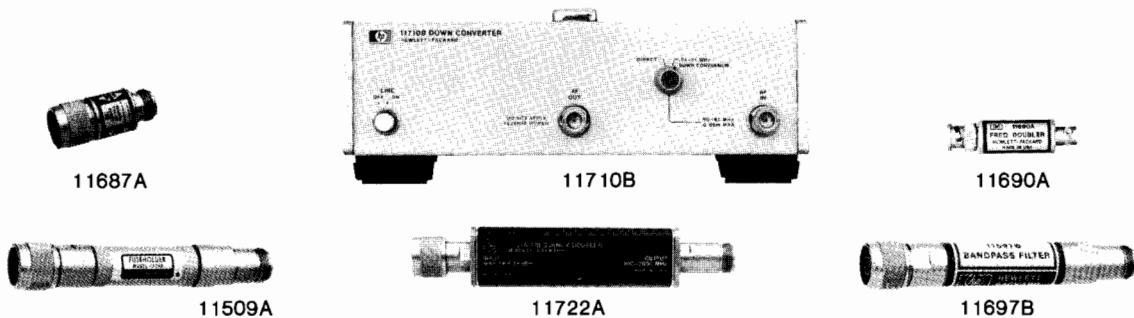

11509A Fuseholder

Accidental burnout of attenuators in HP 8640 and 8654 Signal Generators can be prevented by using this fuse element between the signal generator and a transceiver. The fuseholder has a frequency range of dc to 480 MHz, insertion loss of ≤ 1 dB, SWR of ≤ 1.35 (50 Ω load), and Type N connectors. Ten extra fuses are furnished.

11687A 50-75 Ω Adapter

This 50-75 Ω Adapter with Type N connectors is recommended for use with HP 8640, 8654, 8660, 8656, and 8662 Signal Generators for measurements in 75 Ω systems. The voltage calibration on the output level meter is unaffected by use of the adapter, but 1.76 dB must be subtracted from the dB scale on the meter to determine the output in dBm into 75 Ω . Frequency range is dc to 1300 MHz.

11697A,B,C Bandpass Filters

These filters reduce any harmonic and subharmonic-related spurious signals present in the output of doubled signal sources (such as the HP 8640 Signal Generator with Option 002 Internal Doubler or 11690A external Frequency Doubler). The 11697A and 11697B cover the USA UHF television band and the 11697C covers the range used for navigation aids and mobile radio. Midband attenuation is ≤ 0.6 dB, pass band attenuation is ≤ 1.1 dB, and pass band SWR is ≤ 1.4 . Connectors are Type N.

Rejection Band Attenuation

Model	Below Passband		Above Passband	
	Frequency (MHz)	Attenuation	Frequency (MHz)	Attenuation
11697A	≤ 337	≥ 20 dB	768-3000	≥ 20 dB
11697B	≤ 445	≥ 20 dB	1011-3000	≥ 20 dB
11697C	≤ 550	≥ 20 dB	1333-3000	≥ 20 dB

11690A Frequency Doubler

The 11690A extends the frequency range of all HP 8640 series Signal Generators by doubling the 256-512 MHz frequency band up to 1024 MHz (to 110 MHz with band overrange). All 8640's indicate the correct doubled output frequency on a dial or counter when the 512-1024 MHz range is selected. The 11690A will also perform well with any source meeting the input requirements of 200-550 MHz at +10 to +19 dBm. Conversion loss is < 13 dB, output flatness has < 4 dB total variation, and the 1st and 3rd input harmonics are suppressed > 20 dB. Connectors are BNC.

11710B Down Converter

The 11710B Down Converter is an accessory for the 8640 and 8654 series signal generators. Frequency inputs from 50.01 to 61 MHz are down converted to the 10 kHz to 11 MHz range respectively. The output level and modulation functions of the 8640 and 8654 remain calibrated. A straight-through selection switch allows the input to pass through unchanged, and thus minimizes the necessity to move cables when testing. Option 001 provides rails and semi-rigid coax for combining the 11710B with an 8654A,B Signal Generator.

11710B Specifications

Input

Down-conversion mode: 50.01 to 61.00 MHz at ≤ 0 dBm.

Straight-through mode: 0.01 to 1100 MHz (dc coupled).

Down-Converted Output

Frequency range: 10 kHz to 11 MHz.

Level range: 0 to -107 dBm

Level flatness: RF source flatness ± 0.5 dB (referred to 4.0 MHz).

Total level accuracy: ± 1 dB plus input level accuracy.

Harmonics: > 35 dB below the carrier (dBc).

Intermixing spurious: > 60 dBc.

Local oscillator feed-through (50 MHz): < -100 dBm.

Internal Reference Characteristics

Time base output: 1 MHz or 5 MHz selectable, nominally > 0.5 V p-p into 500 Ω . This will drive an 8640B external time base input.

Typical overall accuracy: (within 3 months of calibration and from 15°C to 35°C): ± 2 ppm.

General

Operating temperature range: 0 to 55°C.

Power requirements: 100, 120, 220, 240V (+5%, -10%), 48 to 440 Hz; 25 VA maximum.

Weight: net, 3.2 kg (7 lb) shipping, 4.5 kg (9 lb).

Size: 102 H \times 266 W \times 295 mm D (4" \times 10.5" \times 11.6"). $\frac{1}{2}$ MW \times 4 H \times 11 D System I Module.

11721A Frequency Doubler

The 11721A Doubler is an ideal accessory for extending the useable frequency range of signal generators, frequency synthesizers, or other signal sources. Operating on input frequencies of 50 MHz to 1300 MHz, it provides a doubled output in the range of 100 MHz to 2600 MHz. The 11721A will work well with any RF source with an output in the range 50 to 1300 MHz.

The 50 Ω passive circuit of the 11721A offers low conversion loss, low spurious, and excellent flatness over its entire frequency range when operated above +10 dBm.

11721A Specifications

Input frequency range: 50 to 1300 MHz.

Output frequency range: 100 to 2600 MHz.

Conversion loss (+13 dBm input, 50 to 1280 MHz): < 15 dB.

Spurious referenced to desired output frequency f (+13 dBm input with harmonics < -50 dBc, 50 to 1280 MHz): $f/2$, -15 dB; $3f/2$, -15 dB.

Input SWR: 1.5 typical.

Input/output impedance: 50 Ω nominal.

Operating temperature range: 0 to +50°C.

Connectors: input, type N male; output, type N female.

Size: 161 L \times 30 W \times 20.5 m H (6 $\frac{3}{8}$ " \times 1 $\frac{1}{16}$ " \times 1 $\frac{1}{16}$ ").

Weight: net, 181 g (6.4 oz). Shipping, 335 g (11.8 oz).

Ordering Information

11509A Fuseholder

11687A 50 Ω -75 Ω Adapter

11690A Frequency Doubler

11697A Bandpass Filter (512-674 MHz)

11697B Bandpass Filter (674-890 MHz)

11697C Bandpass Filter (800-1100 MHz)

11710B Down Converter

Option 001: Combining Kit

Option 910: Extra operating & service manual

11721A Frequency Doubler

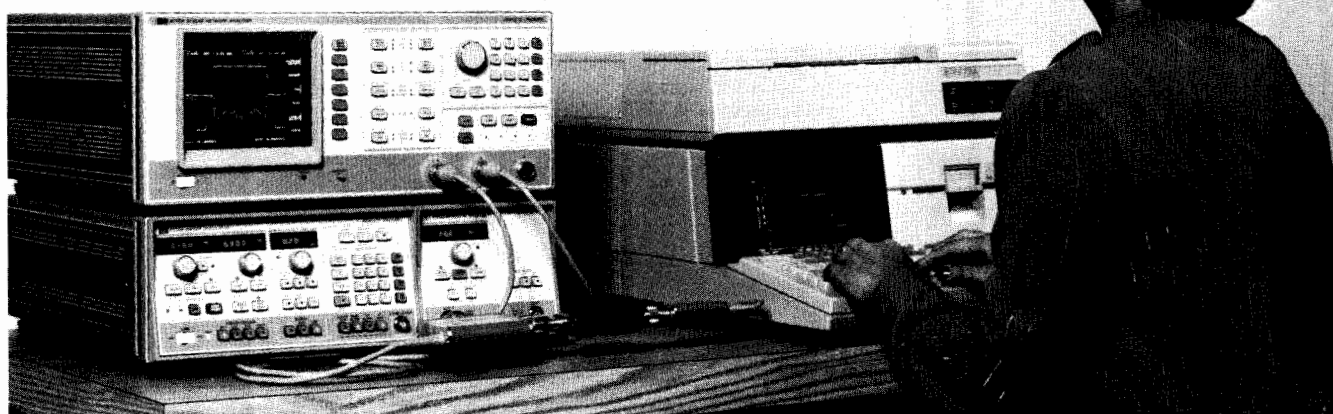

Sweep Oscillators

Swept frequency oscillators are used in applications where the characteristics of a device must be determined over a wide, continuous range of frequencies. Combined with a broadband detector and display test set, sweep oscillators provide many benefits compared to CW frequency sources. A swept measurement provides a dynamic display of the data. The results of any adjustments to the unknown test device are seen immediately (real time) on the display. By replacing laborious point-by-point techniques swept measurements increase the speed and convenience of broadband testing. The continuous frequency characterization of the unknown device also eliminates the chance of missing important information between frequency points. Swept techniques are applicable in all phases of design, manufacture and maintenance.

Hewlett-Packard Sweep Oscillators

Hewlett-Packard sweepers cover the entire frequency spectrum from dc to 40 GHz. Self-contained, multi-octave sweepers cover the frequency range to 110 MHz. The 8620 family of solid state oscillators provide a versatile choice of configurations—single band, straddle band, or very wide band plug-ins from 10 MHz to 22 GHz. 10 MHz to 40 GHz coverage is available in the 8350 family of plug-in sweep oscillators. The 8340A provides broadband synthesized frequency coverage (10 MHz to 26.5 GHz) with excellent stability (5×10^{-10} /day) and phase noise. A chart of the individual frequency bands available appears on page 367.

Sweep Oscillator Features

Sweep Flexibility

Every HP sweeper has several different sweep modes available for setting the fre-

quency limits of the instrument. A full band or independently adjustable start/stop frequency sweep can be selected. Alternatively, a marker sweep or a symmetrical ΔF sweep about the desired center frequency can be chosen. Switching from one sweep mode to another is a simple pushbutton operation. In the auto mode the sweep retriggers automatically. Sweep times from 0.01 to more than 100 seconds can be selected. A manual sweep is also available as a front panel control, a real convenience for calibrating displays such as X-Y recorders. An external trigger is provided as well for applications where the sweeper must be synchronized to other instrumentation or remotely controlled.

On all sweeps a linear voltage proportional to frequency is available on an external connector which is useful for driving the horizontal of a display. Blanking and pen lift signals are also provided at rear output connectors during retrace time when the RF is off.

Marker capability, both Z-axis intensity dots and RF pips, are available on HP sweepers to note your important measurement frequencies. Two or more independent markers are offered on all sweepers with up to five markers on the new 8340A and 8350 mainframe. Crystal markers are offered on the 86222B and 83522A 10 MHz to 2.4 GHz RF plug-ins, and the 83525A/B 10MHz to 8.4 GHz plug-in.

Another powerful feature available on the new 8340A and 8350 sweeper mainframe is Save/Recall Mode. With Save/Recall Mode up to nine complete front panel states can be stored in memory and later recalled when the measurement is repeated. This saves considerable time when repetitive tests are required.

Power Output and Leveling

Power output is continuously adjustable at the front panel over approximately a 10 dB range of all plug-ins. Built-in attenuators are also available on most plug-ins for greater power control. Internal or external leveling is employed to obtain (1) a constant power output and (2) a good source match (low VSWR). This ensures high accuracy when making swept measurements.

The new 8340A and 83500 series of plug-ins offer calibrated output power and internal leveling as standard features. Power is calibrated over a 15 dB range (30dB for the 8340A) with 0.1 dB resolution (programmable to 0.02 dB); with an internal step attenuator, the calibrated range is extended to 85 dB (130 dB on the 8340A).

Power as well as frequency can be swept with the 8340A or the 8350 and 83500 series plug-ins. This means that both the frequency response and power response of level sensitive devices like transistors and amplifiers can be measured using the same test set-up. Using the Power Sweep function 1 dB gain compression can easily be measured at a CW frequency (Figure 1). Also, the ability to alternate between two discreet power levels on successive sweeps (8340A or 8350 and 83500

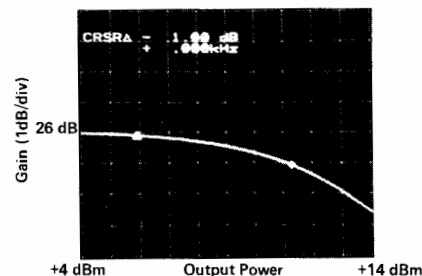

Figure 1.

SWEEP OSCILLATORS

General Information (cont.)

series plug-ins) allows a swept measurement of 1 dB compression point. Output power characteristics can be optimized simultaneously (Figure 2).

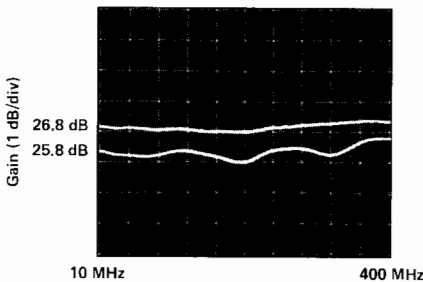

Figure 2.

Modulation

Modulation capabilities further extend the sweeper's usefulness both as a sweeper and a signal generator for signal simulations. Wide AM and FM bandwidths are useful for a variety of tests on communication receivers. The flexible FM capability allows remote analog frequency programming which is important for many applications.

External pulse modulation is also available on many plug-ins. Most plug-ins also accept the 27.8 kHz square wave modulation required by the HP 8756A Scalar Network Analyzer directly, eliminating the need for an external modulator. The 8350 mainframe will supply the 27.8 kHz square wave modulation directly to the plug-in.

The 8340A Synthesized Sweeper has extensive modulation capability, providing both internal pulse and AM modulation. The pulse modulation capability works for pulse widths as narrow as 100 nsec, having rise and fall times less than 25 nsec and ON/OFF ratio greater than 80 dB. The AM is DC coupled and has a 3 dB bandwidth of 100 kHz. The maximum modulation depth varies with available output power but it is never less than 90%. In addition, the 8340A may simultaneously pulse and amplitude modulate the RF to simulate the effect of antenna scan on a pulse modulated signal.

MLA Compatibility

In communications applications where up-converter simulation is required in conjunction with the HP Microwave Link Analyzer, the 86200 series of plug-ins provides this capability as an option in frequency ranges from 500 MHz to 18 GHz. Group delay of less than 1 nanosecond and linearity of better than 0.5% across 30 MHz across most of the frequency range permit very accurate RF to RF, RF to IF and RF to BB distortion measurements. See page XXX for more information.

Programming

The 8340A, 8350 mainframe and 83500 series plug-ins offer total HP-IB control of all front panel functions. Not only CW frequencies, but sweeps, markers, power levels, etc., can be remotely programmed via the HP-IB. This means there are no limitations to designing customized automatic systems for either component or system testing.

The 8620C solid state sweeper mainframe provides optional BCD or HP-IB program-

ming capability. More than ten thousand frequency points per band permit very fine frequency control. In addition, band selection, sweep mode, RF attenuator, and remote-local can be controlled remotely. This allows the sweeper to be used in a wide variety of automatic systems and sophisticated signal simulation applications.

Another way to improve the accuracy and stability of the 8350 or 8620C Sweep Oscillator is to phase-lock the output with the HP 5344S Source Synchronizer. With the 5344S the frequency may be set to a 1 Hz resolution and the long term stability becomes 5×10^{-10} /day. In addition to phase-locking a CW frequency the 5344S when used with a sweeper is also capable of phase continuous locked sweeps up to 40 MHz wide and broadband sweeps with a phase-locked start frequency.

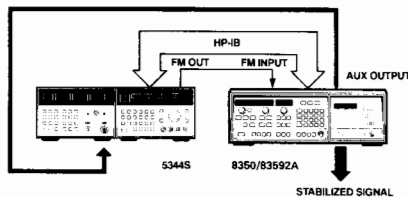

Figure 3.

In many applications, a computer can be used to assimilate data from a network analyzer (HP 8756A or HP 8410C). With automatic systems the computer can completely set up the measurement, sweep width, markers, power level, etc., and then document the measurement results in a printed or plotted format. For operations requiring a minimum of user interactions specification comparisons can be made for automatic "go no-go" testing. Using the programmable power capability of the 83500 series plug-ins, automatic power as well as frequency response testing is possible.

Digital Sweeping Synthesizers

The 3325A, 3330B, 3335A, 8660C, 8662A, and 8673A/S combine the precision frequency accuracy and stability of a synthesizer with the time saving convenience of a sweeper. Parameters such as start/stop/center frequencies, sweep width, frequency step and sweep time are entered and executed through a convenient keyboard or remote programming. Some additional features are phase continuous linear/log sweep in the 3325A and amplitude sweeping in steps as small as 0.01 dB in the 3330B. This in conjunction with frequency sweeping can provide a comprehensive family of curves.

Sweeper Applications

Sweepers are used extensively with swept frequency test sets to characterize the amplitude response of broadband devices or with network analyzers when the phase characteristics of the device (or S-parameters) are also needed. Two measurements—transmission and reflection—are basic to both types of analyzer. Hewlett-Packard offers a complete line of directional couplers, power splitters, and other transducers which together with the analyzers and sweep oscillators provide a total swept measurement solution.

The HP 8756A Scalar Network Analyzer operates over the 10 MHz to 26.5 GHz frequency range (operation at higher frequencies can be achieved using the HP 11664C Detector Adapters). It is a two channel diode detection receiver system with -50 dBm sensitivity and ratio capability. Combined with the 8350 and broadband plug-ins like the 83592 (.01 – 20 GHz) it is ideal for simultaneous magnitude-only transmission and reflection measurements. Convenience is enhanced since the 8350 provides the required 27.8 kHz modulation directly. With the 8756A alternate sweep testing is possible, since Channel 1 is only permitted to respond to the 8350's current state while Channel 2 responds to the alternate state. This allows "simultaneous" measurements of both filter skirt and passband responses (see Figure 4).

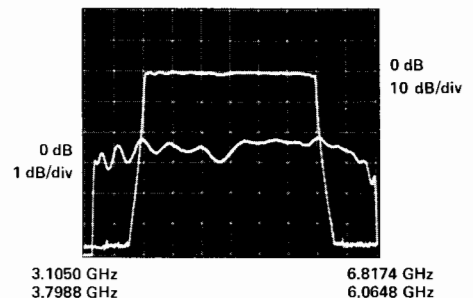

Figure 4.

For measurements requiring low harmonics, the new 83592C RF Plug-in for the 8350 Sweep Oscillator mainframe offers -55 dBc harmonic suppression from 2 to 20 GHz. For measurements that require lower harmonics, more sensitivity and/or phase information, sweepers may be used with network analyzers. For example, with the 83522A or 86222A/B RF Plug-ins and the 8410C Network Analyzer, phase-magnitude transmission or reflection coefficients can be measured across the full, 0.11-2.4 GHz range in one continuous sweep. Since the 8410C is a tuned receiver there is a spurious-free sensitivity of -78 dBm.

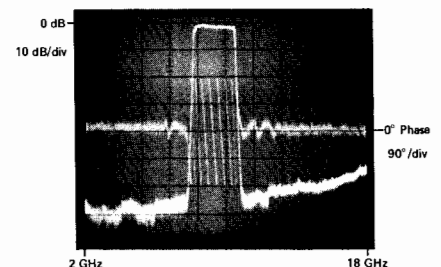

Figure 5.

Figure 5 is a CRT photo of simultaneous phase and magnitude transmission characteristics of an 8 to 10 GHz bandpass filter using the 86290B Sweep Oscillator Plug-in.

For high power applications such as RF-susceptibility tests and high attenuation measurements, Hewlett-Packard offers TWT amplifiers which provide better than 1 watt from 1 to 18 GHz.

Synthesizer accuracy and stability can be obtained by phase-locking the Hewlett-Packard sweep oscillators to a harmonic of a very stable source or to the 5344S Source Synchronizer. This high stability is important in many applications including microwave spectroscopy and high-Q swept frequency measurements.

Noise figure measurements above 1500 MHz can be made using the 8970A Noise Figure Meter with either the 8340A or the 8350 serving as the local oscillator. To perform these measurements the 8970A Noise Figure Meter sends frequency commands over the interface bus (HP-IB) to tune the sweep oscillator to the frequency of interest. With this equipment noise figure and gain measurements can be made on microwave components such as amplifiers, transistors or mixers.

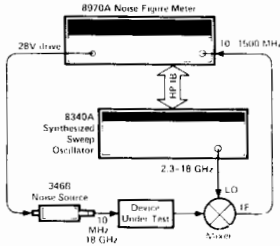

Two-tone sweep testing of devices such as mixers and receiver front ends requires two signals offset from each other by the IF. This is accomplished by phase-locking the difference frequency of two sweep oscillators to a

very stable source. The sweepers may then be swept across the band of interest.

The modulation and built-in attenuator features of Hewlett-Packard sweep oscillators make them useful in many traditional CW signal generator applications. The excellent stability, phase noise, frequency range and modulation capability of the new 8340A make it well suited for most of these applications. In addition, accuracy, linearity, and flatness of the broadband plug-ins like the 83590A, 83594A, 83595A, 83592A/B/C, 86290A/B/C, 83525A/B, 86222A/B, and 83522A make them more than adequate in many applications requiring a general purpose CW generator.

For wideband applications these RF plug-ins feature performance that rivals octave band oscillators in the areas of frequency purity and accuracy, harmonics, flatness, and power.

For a complete discussion of swept frequency measurements the following application notes and others are available from your local Hewlett-Packard sales office.

- AN 155-2 "100 dB Dynamic Range Measurements Using the 8755 Frequency Response Test Set"
- AN 183 "High Frequency Swept Measurements"
- AN 187-6 "Frequency Performance of the 8620C Sweep Oscillator Under Remote Programming"
- AN 312-1 "Configuration of a Two-tone Sweeping Generator"
- PN 8340A-1 "Increasing Frequency

Switching Speed on the HP 8340A Synthesized Sweeper"

- PN 8340A-5 "60 GHz Frequency Coverage Using the HP 8340A Synthesized Sweeper and the WJ 1204-4X Frequency Extender"
- PN 8340A-6 "Reduced Harmonic Distortion Using the Integra TMF-1800H Tracking Filter with the HP 8340A Synthesized Sweeper"
- PN 8340A-7 "Microwave Noise Figure Measurements Using the 8340A Synthesized Sweeper with the 8970A Noise Figure Meter"
- PN 8350A-1 "Using the HP 8350A Sweep Oscillator with the Wiltron 560 Scalar Network Analyzer"
- PN 8350A-2 "Improved Frequency Accuracy by Calibrating HP 83590 Series RF Plug-ins to HP 8350A Sweep Oscillator Mainframe"
- PN 8350-3 "A Penlift Dwell Circuit for the HP 8350 Sweep Oscillator"
- PN 8350A-5 "60 GHz Frequency Coverage Using the HP 8350A Sweep Oscillator and WJ 1204-4X Frequency Extender"
- PN 8350-6 "Reduced Harmonic Distortion Using the Integra TMF-1800H Tracking Filter with the HP 8350 Sweep Oscillator"
- PN 8350A-7 "Microwave Noise Figure Measurements Using the 8350A Sweep Oscillator with the 8970A Noise Figure Meter"
- PN 8620C-1 "Using the HP 8620C Sweep Oscillator with the Wiltron 560 Scalar Network Analyzer"
- PN 8756A-1 "Automating the 8756A Scalar Network Analyzer"

Sweep Oscillator—Summary Chart

Frequency Range*	Model Number			100 kHz	1 MHz	10 MHz	100 MHz	1 GHz	2 GHz	4 GHz	8 GHz	12 GHz	18 GHz	26 GHz	40 GHz
	8350 Series	8620 Series**	Other Sweepers												
0.1 Hz-13 MHz 10 Hz-21 MHz 1 μHz-21 MHz 1 mHz-50 MHz 200 Hz-80 MHz 10 kHz-1280 MHz 10 kHz-2600 MHz			3312A 3336A/B/C 3325A 8165A 3335A 8662A 8660C												
100 kHz-110 MHz 10 MHz-1.3 GHz 10 MHz-2.4 GHz 10 MHz-8.4 GHz 10 MHz-20 GHz 10 MHz-26.5 GHz 10 MHz-26.5 GHz	83522A 83525A/B 83592A/B 83595A	86220A 86222A/B	8601A 8340A 8673S												
1.7-4.3 GHz 1.8-4.2 GHz 2-8.4 GHz 3.6-8.6 GHz 2-18.6 GHz 2-20 GHz 2-22 GHz 2-26.5 GHz	83540A/B 83590A 83594A	86235A 86230B 86240A/B 86240C 86290A/B/C 86290A/B Opt H08	8673A												
3.2-6.5 GHz		86241A													
5.9-9.0 GHz 5.9-12.4 GHz 7-11 GHz 7.5-18.6 GHz 8-12.4 GHz	83545A	86242D 86245A 86250D Opt H08 86251A 86250D													
10-15.5 GHz 12.4-18 GHz 17-22 GHz 18-26.5 GHz 26.5-40 GHz	83570A 83572A/B	86260B 86260A 86260C													

*Other Special Frequency Ranges Can Be Provided Upon Request.

**86200 Series RF Plug-ins are usable with the 8350A Mainframe via the 11869A Adapter. 83500 Series Plug-ins are not usable in the 8620C Mainframe.

SWEEP OSCILLATORS

Synthesized Sweeper

Model 8340A

- 10 MHz to 26.5 GHz synthesized frequency coverage
- 1 to 4 Hz frequency resolution
- Low spurious and phase noise
- 100 Hz to 26.49 GHz ΔF sweep capability
- 100 ns pulse width performance
- DC to 100 kHz amplitude modulation

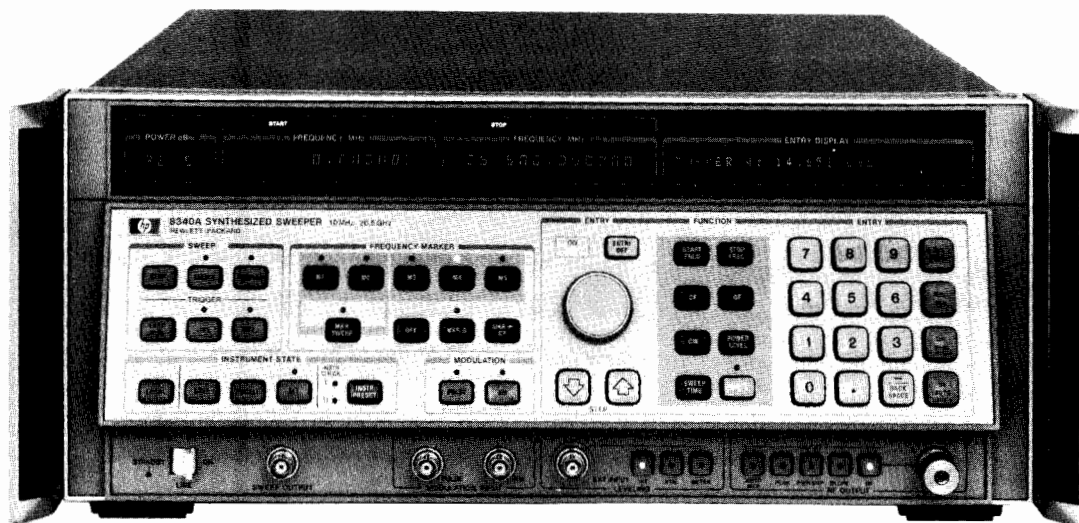

8340A



8340A Synthesized Sweeper

The 8340A Synthesized Sweeper delivers the combined high-performance of a synthesizer and a broadband sweep oscillator in one efficient instrument that is completely controllable via the Hewlett-Packard Interface Bus (HP-IB). This efficient combination of performance and versatility is ideal for manual or automatic test systems and in many cases enables the 8340A to replace a sweep oscillator, a frequency counter, an RF synthesizer, and a microwave synthesizer.

Synthesizer Precision and Spectral Purity

The synthesized 10 MHz to 26.5 GHz frequency coverage and the precise 1 to 4 Hz frequency resolution (depending on the frequency band) of the 8340A are generated by indirect synthesis techniques. These techniques enable the 8340A to achieve the same low single-sideband phase-noise performance as the HP 8672A and HP 8673A Synthesized Signal Generators. The 8340A long-term stability is also outstanding at 1×10^{-7} /day (see specification on following page for more information).

The 8340A also features CW switching times of better than 50 ms (typically <35 ms). Additionally, a "Fast Phase-lock" programming command can be used to reduce typical CW switching times to between 11 and 22 ms (depending on frequency step size and absolute frequency value).

Swept Capability

Analog sweep widths as narrow as 100 Hz or as broad as 26.49 GHz permit the 8340A to rapidly and thoroughly test any device within its broad frequency range. To simplify swept measurements, five frequency markers are provided along with useful marker functions such as Marker Sweep, Marker to Center Frequency (MKR-CF), and Marker Difference. Direct compatibility with the HP 8410, 8755, and 8756 Network Analyzers also enhances the 8340A's swept capability.

Pulse and AM Modulation

The high performance pulse modulator of the 8340A offers >80 dB ON/OFF ratio and <25 ns rise and fall times. Pulse amplitudes are leveled for pulse widths as narrow as 100 ns. The 8340A also features DC-coupled AM modulation with a 3 dB bandwidth of 100 kHz and a minimum depth of 90%. Pulse and amplitude modulation can be used simultaneously to simulate antenna scan patterns.

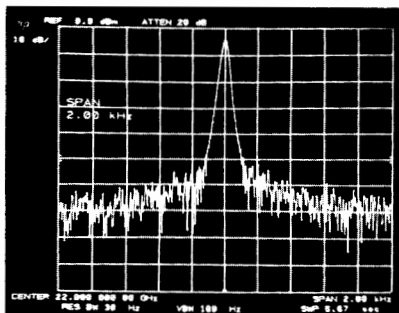

Spectrum Analyzer photo of 8340A signal at 22 GHz.

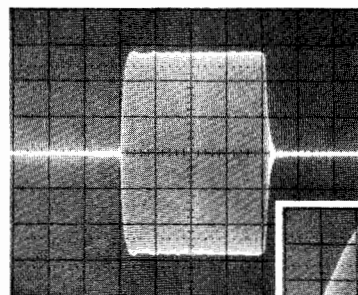

8340A Pulse performance at 3 GHz. Pulse width = 200 ns.

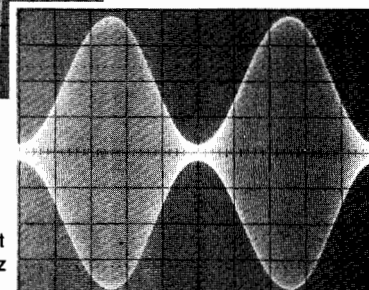

8340A AM performance at 22 GHz. AM rate is 50 kHz and depth is 90%.

Output Power

The 8340A provides high output power which can be controlled down to -110 dBm with 0.05 dB resolution. High power resolution is complemented by outstanding accuracy and flatness, as shown on the following page of specifications. The 8340A also features power sweep capability with >20 dB dynamic range for complete characterization of level-sensitive devices.

Usability and Programmability

The ENTRY DISPLAY of the 8340A always shows the active function and its current value, which can be easily changed via the data entry keyboard, the step keys on the knob. This friendly and responsive interaction with the user makes the 8340A a very easy instrument to operate. Complete HP-IB programmability also enables the 8340A to effectively interact with a computer via simple-to-use programming codes (for example, a CW frequency of 5 GHz can be programmed by: CW 5 GZ). Other HP-IB enhanced features, like the "Fast Phase-lock" command, let the user easily and fully exploit the powerful capabilities of the 8340A.

8340A Specifications

(See technical data sheet for complete specifications)

Frequency

Range: 10 MHz to 26.5 GHz.

CW Mode (and manual sweep)

Frequency Resolution (per frequency band 0-4)

1 Hz, 0.01 to <2.3 GHz (Band 0).

1 Hz, 2.3 to <7.0 GHz (Band 1).

2 Hz, 7.0 to <13.5 GHz (Band 2).

3 Hz, 13.5 to <20.0 GHz (Band 3).

4 Hz, 20.0 to <26.5 GHz (Band 4).

Accuracy: same as the timebase.

Time base: internal 10 MHz time base.

Aging rate: less than 1×10^{-9} /day and 2.5×10^{-7} /year after 7 day warm-up.

Switching time: <50 ms to be within specified frequency band resolution (PEAK function off). Fast Phase-lock mode (via HP-IB) can reduce switching times to <20 ms.

Swept Mode

Center Frequency/Sweep Width (ΔF)

Swept capability: analog sweep, ΔF from 100 Hz to 26.49 GHz; forward sweep times from 10 ms to 200 s.

Resolution: approximately 0.1% of sweep width (ΔF).

Readout accuracy (sweep time >100 ms)

$\Delta F \leq n \times 5$ MHz: $\pm 1\%$ of indicated sweep width (ΔF) \pm time base accuracy.

$\Delta F > n \times 5$ MHz to $< n \times 100$ MHz: $\pm 2\%$ of indicated sweep width (ΔF).

$\Delta F \geq n \times 100$ MHz: $\pm 1\%$ of indicated sweep width (ΔF), or ± 50 MHz, whichever is less.

(where n=frequency band number as shown in CW MODE Frequency Resolution above).

Start/Stop Frequency

Range: 10 MHz to 26.499999 GHz (Start). 10.0001 MHz to 26.5 GHz (Stop).

Resolution: same as Center Frequency/Sweep Width.

Readout accuracy: same as Center Frequency/Sweep Width.

Frequency Markers

All 5 markers are independently variable and have the same specifications.

Range: 10 MHz to 26.5 GHz.

Resolution: same as Center Frequency/Sweep Width.

Readout accuracy: same as Center Frequency/Sweep Width.

Readout accuracy in MKR Δ mode: same as Center Frequency/Sweep Width.

Spectral Purity

Specifications below apply to CW mode and all swept modes unless otherwise stated.

Spurious Signals (expressed in dB relative to the carrier level (dBc) at ALC level of 0 dBm)

Harmonics (up to 26.5 GHz) of output frequency: <-35 dBc.

Subharmonics and Multiples Thereof (up to 26.5 GHz) of output frequency

<-25 dBc, 7.0 to <20.0 GHz

<-20 dBc, 20.0 to 26.5 GHz

Non-Harmonically Related Spurious (CW and Manual sweep mode only)

<-55 dBc, .01 to < 2.3 GHz

<-70 dBc, 2.3 to < 7.0 GHz

<-64 dBc, 7.0 to <13.5 GHz

<-60 dBc, 13.5 to <20.0 GHz

<-58 dBc, 20.0 to 26.5 GHz

Single-Sideband Phase Noise (dBc/1 Hz Noise BW, CW Mode, all power levels)

Frequency Range (GHz)	Offset from Carrier				
	30 Hz	100 Hz	1 kHz	10 kHz	100 kHz
0.01 to < 2.3	-64	-70	-78	-86	-107
2.3 to < 7.0	-64	-70	-78	-86	-107
7.0 to <13.5	-58	-64	-72	-80	-101
13.5 to <20.0	-54	-60	-68	-76	-97
20.0 to 26.5	-52	-58	-66	-74	-95

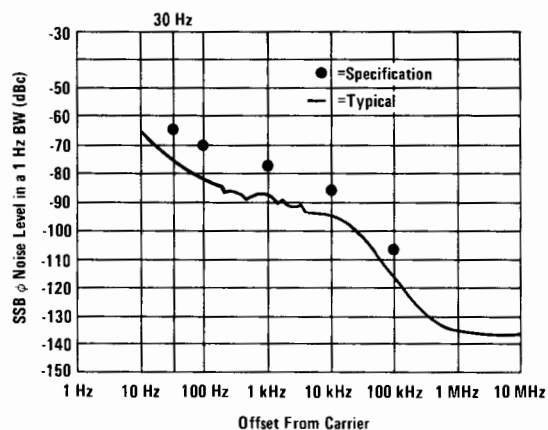

Typical 8340A Phase Noise performance from 2.3 to 7.0 GHz.

RF Output

Range: -110 dBm to +20 dBm.

Resolution: 0.05 dB in ENTRY DISPLAY.

Maximum Leveled Power (0°C to +35°C)

Frequency Range	Specified	Typical
0.01 to < 2.3 GHz	+10.0 dBm	+12 dBm
2.3 to < 7.0 GHz	+12.0 dBm	+16 dBm
7.0 to <13.5 GHz	+10.0 dBm	+12 dBm
13.5 to <20.0 GHz	+ 9.0 dBm	+11 dBm
20.0 to <23.0 GHz	+ 3.0 dBm	+ 5 dBm
23.0 to <26.5 GHz	+ 1.0 dBm	+ 3 dBm

Output Power Accuracy (0°C to +55°C)

Output Level Range	Frequency Range (GHz)		
	0.01 to <2.3	2.3 to <20	20 to 26.5
+20 to +10 dBm	—	± 1.8 dB	± 2.3 dB
+10 to -9.95 dBm	± 0.9 dB	± 1.5 dB	± 2.0 dB
-10 to -19.95 dBm	± 1.2 dB	± 2.0 dB	± 2.5 dB
-20 to -49.95 dBm	± 1.5 dB	± 2.3 dB	± 2.8 dB
-50 to -79.95 dBm	± 1.8 dB	± 2.6 dB	± 3.1 dB
-80 to -100 dBm	± 2.1 dB	± 2.9 dB	± 3.4 dB
-100 to -110 dBm (typically)	± 2.9 dB	± 3.7 dB	± 4.2 dB

Accuracy specifications include power level variations with frequency and temperature (i.e. flatness, which is given on following page).

SWEEP OSCILLATORS

Synthesized Sweeper (cont.)

Model 8340A

Flatness (internally leveled, 0°C to +55°C)

Output Level Range	Frequency Range (GHz)		
	0.01 to <2.3	2.3 to <20	20 to 26.5
+20 to +10 dBm	—	±1.2 dB	±1.7 dB
+10 to -9.95 dBm	±0.5 dB	±1.1 dB	±1.6 dB
-10 to -19.95 dBm	±0.8 dB	±1.6 dB	±2.1 dB
-20 to -49.95 dBm	±1.1 dB	±1.9 dB	±2.4 dB
-50 to -79.95 dBm	±1.4 dB	±2.2 dB	±2.7 dB
-80 to -100 dBm	±1.7 dB	±2.5 dB	±3.0 dB
-100 to -110 dBm (typically)	±1.9 dB	±3.1 dB	±3.6 dB

Output level switching time: typically <10 ms to be within ±0.1 dB of final value with no attenuator change (internal leveling only).

Stability with temperature: typically ±0.01 dB/°C.

Output impedance: 50 Ω nominal.

Source SWR (internally leveled only)

Typically <1.3:1, 0.01 to <2.3 GHz.

Typically <1.6:1, 2.3 to <18.0 GHz.

Typically <2.0:1, 18.0 to 26.5 GHz.

Power Sweep

Calibrated range: 20 dB minimum when ALC and step attenuator are operated independently. Actual available range determined by difference of maximum leveled power available at frequency of interest and -20 dBm.

Resolution: 0.05 dB/sweep.

Slope Compensation

Calibrated Range: 0 to 1.5 dB/GHz.

Resolution: 0.001 dB/GHz.

External Leveling

XTAL: allows the 8340A to be externally leveled by crystal detectors of positive or negative polarity.

METER: allows power meter leveling with any HP power meter.

Range: 500 μV (-66 dBV) to 2V (+6 dBV) for XTAL or METER modes.

Accuracy: leveled voltage is shown in ENTRY DISPLAY in dBV. Accuracy of actual voltage at EXT INPUT relative to the displayed value is: ±0.5 dB ±0.2 mV.

Loop bandwidth: nominally 30 kHz in XTAL mode, 0.7 Hz in METER mode.

Input impedance: nominally 1 MΩ.

Pulse Modulation

ON/OFF ratio: >80 dB.

Rise (T_R) and fall (T_F) times: <25 ns.

Minimum internally leveled RF pulse width (T_{RF}): <100 ns.

Minimum unleveled RF pulse width: typically <25 ns.

Pulse Repetition Frequency

100 Hz to 5 MHz (when internally leveled).

Typically dc to 20 MHz in unleveled operation.

Maximum peak power: same as CW and swept modes. See RF OUTPUT specifications.

Accuracy of Internally Leveled RF Pulse (V_p) (relative to CW level)

Pulse Width	Frequency (GHz)		
	0.01 to <0.4 (typ)	0.4 to <2.3	2.3 to 26.5
100 to <200 ns	—	+3/-0.3 dB	±1.5/-0.3 dB
200 to <500 ns	—	+1.5/-0.3 dB	±0.3 dB
≥500 ns	—	±0.3 dB	±0.3 dB
1 to <2 us	+3/-0.3 dB	±0.3 dB	±0.3 dB
2 to <5 us	+1.5/-0.3 dB	±0.3 dB	±0.3 dB
≥5 us	±0.3 dB	±0.3 dB	±0.3 dB

Overshoot, ringing (V_{OR}/V_p): <15% typical.

Pulse width compression (T_V-T_{RF}): ±5 ns typical.

Delay time (T_D): 50 ns typical.

Video Feedthrough (V_F/V_p)

0.01 to <0.4 GHz: <100% (typical)

0.4 to <2.3 GHz: <5% (for output power levels ≤+8 dBm)

2.3 to 26.5 GHz: ≤0.2%

Sidebands (caused by a pulse input when PULSE is OFF): typically -50 dBc with a 30 kHz squarewave input from .01 to 7.0 GHz.

Pulse input: TTL compatible. (Open circuit is TTL high level and keeps RF on). Damage level +12 Vdc, -20 Vdc.

Pulse Definitions

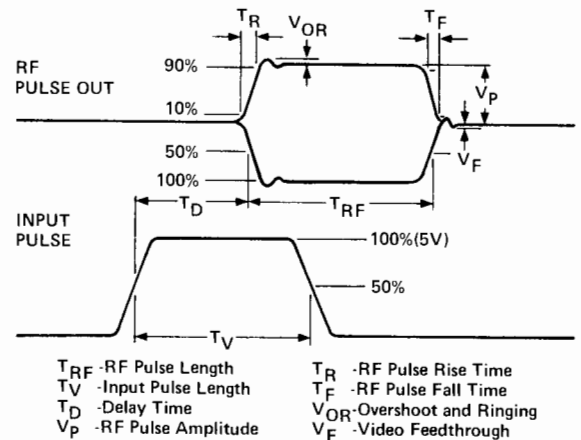

Amplitude Modulation

Rates (3 dB BW): DC to 100 kHz.

Depth: 0 to 90%.

Sensitivity: 100%/V.

Distortion: typical values are given in figure below.

Incidental θ M in peak radians (Rates ≤10 kHz, 30% Depth): <0.4 typical.

Incidental FM: incidental θ M × Modulation Frequency.

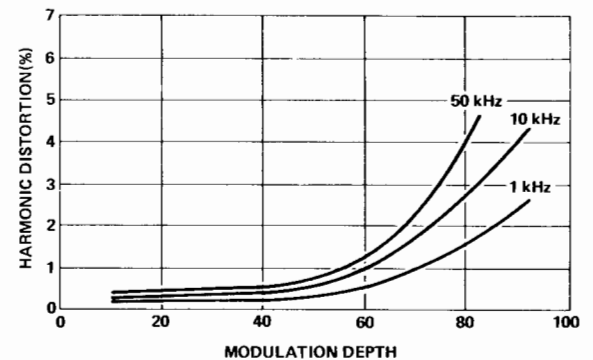

Typical 8340A AM distortion for various modulation rates and depths.

Remote Operation

All front panel functions (except line power) may be programmed via the Hewlett-Packard Interface Bus (HP-IB).

General

Temperature: operation 0°C to 55°C except as noted in electrical specifications.

Power requirements: 47.5 to 66 Hz; 100, 120, 220, or 240 volts (±10%); 500 VA maximum (40 VA in STANDBY).

Weight: 34 kg (75 lbs).

Dimensions: 188 H x 425.5 W x 609.6 mm D (7.4" x 16.75" x 24.0").

Ordering Information

8340A Synthesized Sweeper

Opt 001: Front Panel RF Output Without Attenuator

Opt 003: Operation at 400 Hz Line only

Opt 004: Rear Panel RF Output With Attenuator

Opt 005: Rear Panel RF Output Without Attenuator

Opt 806: Rack Mount Slide Kit

Opt 850: 8410B/C Interface Cable

Opt 908: Rack Flange Kit

Opt 910: Extra Operating and Service Manual

Opt 913: Rack Flange Kit for Instruments With Front Handles

08340-60134 Support Kit

SWEEP OSCILLATORS

Digital Marker, Generator/Sweeper and Power Meter Leveling Amplifier

Models 8600A, 8601A and 8404A

371

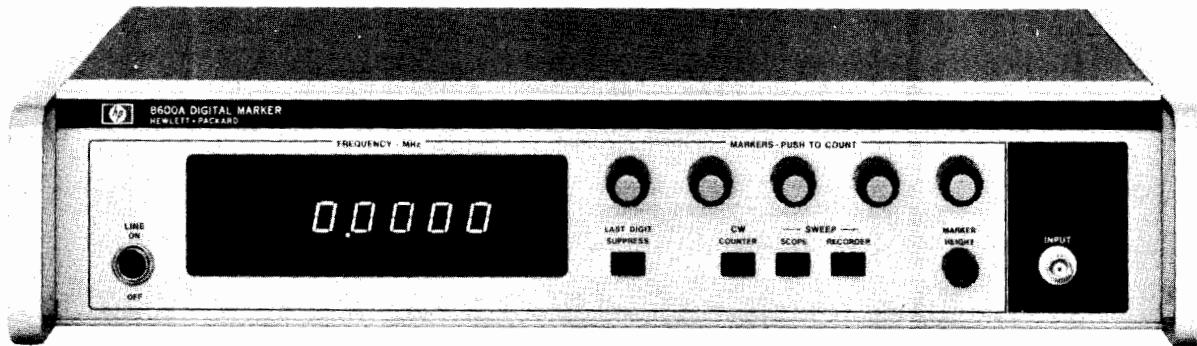

8600A

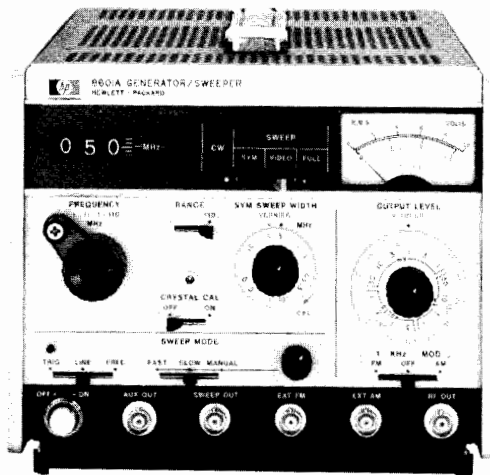

8601A

Harmonics and spurious signals: (CW above 250 kHz, output levels below +10 dBm) harmonics at least 35 dB below carrier. Spurious at least 40 dB below carrier.

Residual FM: noise in a 10 kHz bandwidth including line related components (dominant component of residual FM is noise).

CW: <50 Hz rms, low range; <500 Hz rms high range.

SYM 0, sweep: <100 Hz rms, low range; <1 kHz rms, high range.

Residual AM: AM noise modulation index (rms, 10 kHz bandwidth) is <-50 dB; (typically -60 dB at 25°C).

Crystal calibrator: internal 5 MHz crystal allows frequency calibration to $\pm 0.01\%$ at any multiple of 5 MHz.

Sweep modes: full, video, and symmetrical.

Internal AM: fixed 30% $\pm 5\%$ at 1 kHz; <3% distortion.

External AM: 0 to 50%, dc to 400 Hz; 0 to 30%, up to 1 kHz.

Internal FM: 1 kHz rate, fixed 75 kHz $\pm 5\%$, deviation, high range; 7.5 kHz $\pm 5\%$, deviation, low range; <3% distortion.

External FM: sensitivity, 5 MHz per volt $\pm 5\%$, high range, 0.5 MHz per volt $\pm 5\%$, low range; negative polarity; FM rates to 10 kHz.

Weight: net, 9.5 kg (21 lb). Shipping, 12.3 kg (27 lb).

Size: 155 mm H x 190 mm W x 416 mm D ($6\frac{3}{32}$ " x $7\frac{25}{32}$ " x $16\frac{3}{8}$ ").

The Model 8600A Digital Marker provides five independent, continuously variable frequency markers over the range 0.1-110 MHz when used with the HP 8601A Generator Sweeper.

The high resolution controls and 6-digit readout permit 0.05% frequency settability. The frequency of any marker may be read while sweeping, simply by pushing a button within the marker control. The marker selected is brighter than the others and points in the opposite direction, ensuring positive marker identification.

8600A Digital Marker Specifications

Marker accuracy: any marker may be placed at a desired frequency $\pm (0.05\%$ of sweep width + sweeper stability).

Weight: net, 5.8 kg (13 lb). Shipping 8.2 kg (18 lb).

Size: 99 mm H x 413 mm W x 337 mm L ($3\frac{9}{16}$ " x $16\frac{1}{4}$ " x $13\frac{1}{4}$ ").

8404A Power Meter Leveling Amplifier

The 8404A Leveling Amplifier permits the HP 431B/C or HP 432A/B/C Power Meter to level the HP 8620 sweeper plug-ins. RF output is leveled to ± 0.5 dB or less when connected to the AM input of the sweeper.

Ordering Information

8600A Digital Marker

Opt 001: Modification kit for 8690B/8698B

8601A Generator/Sweeper

Opt 008: 75 Ω BNC output

8404A Power Meter Leveling Amplifier

Opt 001: 4 line BCD level control

Covering 100 kHz to 110 MHz, the Model 8601A Generator/Sweeper combines the high linearity and flatness of a precision sweeper with a signal generator's frequency accuracy and wide range of calibrated power levels. Though it's small and lightweight, it does the work of two instruments easily and conveniently.

8601A Generator/Sweeper Specifications

Frequency range: low range, 0.1-11 MHz; high range, 1-110 MHz.

Frequency accuracy: approximately $\pm 1\%$ of frequency.

Power output: +20 to -110 dBm; 10-dB steps and 13-dB vernier provide continuous settings over entire range. Meter monitors output in dBm and rms volts into 50 Ω .

Power accuracy: ± 1 dB accuracy for any output level from +13 dBm to -110 dBm.

Flatness: ± 0.25 dB over full range, ± 0.1 dB over any 10 MHz portion (+10 dBm step or below).

Impedance: 50 Ω , SWR <1.2 on 0 dBm step and below.

SWEEP OSCILLATORS

8350 Series: 10 MHz to 40 GHz

Model 8350 Series

- Versatile microprocessor-controlled mainframe
- Single-band, straddle-band and broad band plug-ins
- 10 MHz to 40 GHz in two plug-ins
- 10 mW output power to 26.5 GHz
- Total HP-IB programmability

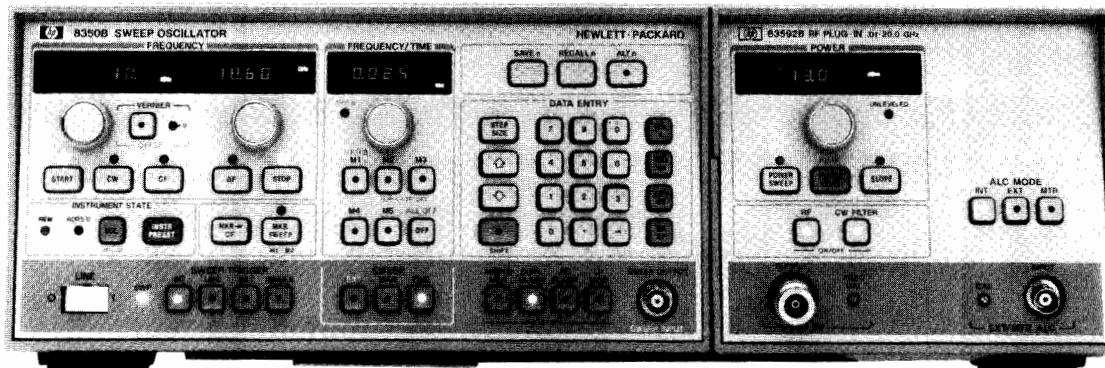

8350B



8350 System

The HP 8350 is a powerful RF and microwave source for swept measurements, wideband CW signal generation and automatic testing. It incorporates the efficiency of microprocessor control with state-of-the-art YIG-tuned oscillators and GaAs FET amplifiers to produce a high performance sweep oscillator system ideally suited for either manual or automatic measurements.

You can easily configure a source to meet your application's frequency coverage and power requirements. Just combine the versatile 8350 mainframe with any of the 34 standard RF plug-ins (see table at right) and you are ready to make measurements. Both the advanced 83500 series plug-ins and the existing 86200 series plug-ins (via the 11869A adapter) are accepted by the 8350 mainframe.

8350 Mainframe

The 8350 has been designed to include many features that not only speed and simplify measurements but also improve accuracy. In addition, it is the first sweep oscillator to provide total computer control of all front panel function settings.

All function values (sweep limit frequencies, marker frequencies, etc.) are indicated on high resolution digital displays, thus eliminating the time consuming task of reading and interpolating between dial scale graduations. Function values are easily modified using the appropriate knob, step keys, or data entry keyboard. The knob provides a "continuous" analog feel while the step keys allow values to be increased or decreased by specific amounts. Fast entry of precise values is made from the data entry keyboard.

Five independent, continuously variable markers are available to note your measurement frequencies. The active marker frequency or the difference frequency between any two markers is read easily from high resolution digital display. You can also use marker sweep to zoom in on a particular frequency span while retaining your original sweep limits.

Another particularly useful feature in making repetitive measurements is the 8350's Save/Recall Mode. Once the sweeper has been set for a particular measurement, all front panel settings (8350 and 83500 series plug-in) can be *Saved* and later *Recalled* to repeat the measurement by accessing one of nine internal storage registers.

In the past, HP-IB programming of sweepers was limited to a series of CW frequencies. With the 8350 all front panel functions, e.g. sweeps, markers, sweep time, even output power (83500 series plug-ins) can be programmed. This means there are no limitations in designing your own customized test systems. Utilizing the Learn Mode function, the 8350 becomes a "talker" as well as "listener" on the bus, transferring all manually entered front panel controls to the computer.

Full compatibility with both the HP 8410C Network Analyzer and the HP 8756A Scalar Network Analyzer are provided for convenient vector and scalar measurement with the 8350B. The HP 5343A Counter can be combined with the 8350 to measure Start, Stop, or marker frequencies with up to 100 kHz accuracy while sweeping. Improved frequency accuracy and stability may be achieved by using the HP 5344S Source Synchronizer with the 8350 to phase-lock the RF output. Microwave noise figure measurements may be made using the 8350 with the HP 8970A Noise Figure Meter.

83500 Series Plug-Ins

Broadband frequency coverage from 10 MHz to 40 GHz with high output power is provided in the 83500 series RF plug-ins. One plug-in, the 83595A, operates over the entire 10 MHz to 26.5 GHz range without sacrificing frequency accuracy (15 MHz at 26.5 GHz). The new 83592C, 10 MHz to 20 GHz RF plug-in has -55 dBc harmonics and subharmonics from 2 to 20 GHz. The 18 GHz to 26.5 GHz band is filled by the 83570A RF plug-ins and boasts a 10 mW power level (comparable to most BWO's). The 26.5 to 40 GHz band is covered by the new 83572A and 83572B RF plug-ins that have minimum unleveled power output of 2 mW and 5 mW respectively.

The 83500 series plug-ins offer output power level control previously unavailable on a swept source. First, power level control is calibrated with 0.1 dB resolution and up to 80 dB range (with Opt 002 attenuator). Second, calibrated power sweeps are available for characterizing device performance as a function of power. And third, slope and internal leveling controls are standard on all units.

All 83500 series front panel functions and HP-IB programmable including power level. This means your automatic test systems can now characterize a device both as a function of frequency and input power level.

86200 Series Plug-Ins

Simply combining the 86200 series plug-in (including the one you may already own) with an 11869A Adapter makes all the convenient digital controls, markers, and HP-IB capability of the 8350 immediately available to you. The 86200 series are a particularly attractive plug-in choice when economical single-band operation is desired with the 8350 mainframe. For measurements with HP Microwave Link Analyzer, specially characterized 86200 series plug-ins can be used with the 8350 to create an upconverter for communications distortion measurements.

The 86290A/B/C plug-ins cover the 2-18 GHz frequency range with 5 mW, 10 mW, and 20 mW of output power respectively. Frequency accuracy at 18 GHz is 20 MHz exceeding that available on most single-band plug-ins. Both 83500 series and 86200 series plug-ins compatible with the 8350 Mainframe are summarized in the table below. Note that the 11869A Adapter is required with all 86200 series plug-ins. See specifications on page 384.



11869A

86290B

83540A



	Model number	Frequency range (GHz)	Leveled power output	Frequency accuracy (MHz)	Complete specifications on page
Broad-band Plug-ins	83595A	0.01-26.5	2.5 mW	±12	376, 377
	83594A	2-26.5	2.5 mW	±12	376, 377
	83592A/B	0.01-20	10 mW/20 mW*	±10	376, 377
	83592C	0.01-20	4 mW	±10	376, 377
	83590A	2-20	6.3 mW	±10	376, 377
	83525A/B	0.01-8.4	20 mW/10 mW	±7	378, 379
	83522A	0.01-2.4	20 mW	±5	378, 379
	86222A/B	0.01-2.4	20 mW	±10	388
	86290A	2-18	5 mW	±20	387
	86290B	2-18.6	10 mW	±20	387
86290C	2-18.6	20 mW	±20	387	
Straddle-band Plug-ins	83540A/B	2-8.4	40 mW/20 mW	±7	380, 381
	86240A	2-8.4	40 mW	±20	389
	86240B	2-8.4	20 mW	±20	389
	86240C	3.6-8.6	40 mW	±20	389
	86251A	7.5-18.6	10 mW	±20	389
Single-band Plug-ins	86220A	0.01-1.3	10 mW	±10	390, 391
	86230B	1.8-4.2	10 mW	±15	390, 391
	86235A	1.7-4.3	40 mW	±20	390, 391
	86241A	3.2-6.5	3.2 mW	±30	390, 391
	86242D	5.9-9	10 mW	±35	390, 391
	83545A	5.9-12.4	50 mW	±40	380, 381
	86245A	5.9-12.4	50 mW	±40	390, 391
	86250D	8.0-12.4	10 mW	±40	390, 391
	86260B	10-15.5	10 mW	±50	390, 391
	86260A	12.4-18	10 mW	±50	390, 391
	86260C	17-22	10 mW	±50	390, 391
	83570A	18-26.5	10 mW	±30	382, 383
	83572A	26.5-40	1.6 mW (Opt 001)	±100	382, 383
	83572B	26.5-40	4 mW (Opt 001)	±100	382, 383

NOTE: The 11869A Adapter is required to interface 86200 series plug-ins with the 8350A mainframe.
*83592B: 20 mW to 18.6 GHz.

374



SWEEP OSCILLATORS

8350 Series: Mainframe

Model 8350B

- Accurate, high resolution, digital displays
- Five markers with marker Δ and marker sweep
- Save/Recall 9 complete front panel states
- Accepts all 83500 series plug-ins
- Total HP-IB programmability

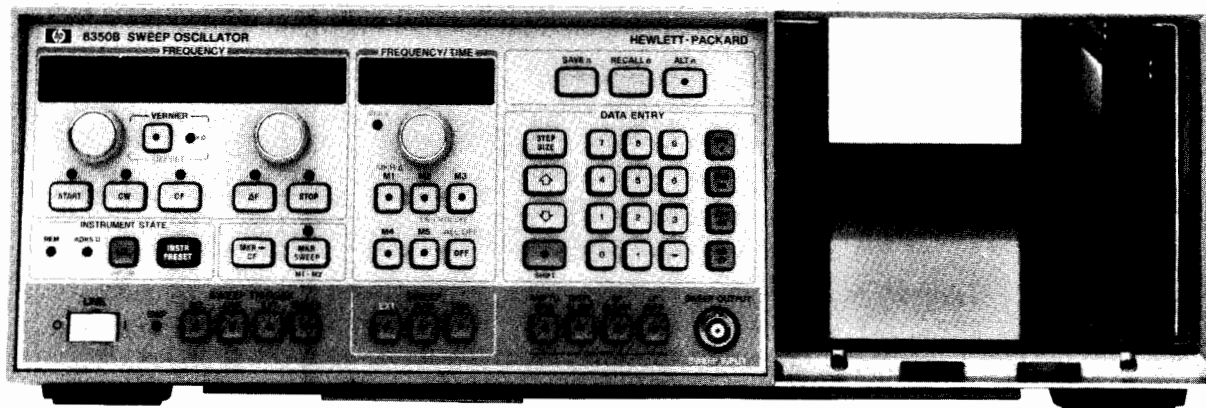

8350B



8350B Mainframe

Sweep Oscillator applications are greatly expanded by the new features of the HP 8350B. Along with the traditional swept and CW frequency functions the 8350B adds five markers with extensive capabilities, versatile data entry and complete HP-IB programmability. The 8350B mainframe accepts the 86200 series plug-ins via the 11869A Adapter as well as the new wideband 83500 series plug-ins. In order to aid system set ups, the 8350B is directly compatible with the HP 8410C and HP 8756A network analyzers. The frequency accuracy is easily enhanced when the HP 5343A Counter is used to count the START, STOP, or ACTIVE MARKER frequency. For even more frequency accuracy and stability the HP 5344S Source Synchronizer may be used to phase-lock the RF output.

The 8350B has three methods of changing function values; control knobs, keyboard entry, or step key entry. The traditional control knob provides an analog "feel" of control which is useful for continuous parameter adjustment. Numerical keyboard entry allows for fast, accurate input. Finally, quantized inputs are possible with step keys.

Five markers are available with the 8350B. These markers combined with the high resolution digital readout make the accurate location of important frequency responses easy. A key marker feature, marker Δ , computes the difference between any two markers. While the markers are in this mode the trace is intensified between the two markers, thereby aiding the user's visual comprehension. This feature is particularly useful for measurements such as the determination of the bandwidth between 3 dB points. With the extensive marker capabilities key frequency ranges may be marked and swept. The markers can modify the center frequency (marker \rightarrow CF) or the START/STOP frequency (Marker Sweep). These expanded marker capabilities simplify sophisticated measurements.

A necessity in making repetitive measurements or automatic tests is the Save/Recall Feature. Once the 8350B controls have been set for a

particular measurement, all of the front panel controls can be "Saved" in a memory location and later "Recalled" when the measurement is repeated. This feature supplies nine memory locations, each storing a complete front panel set up. Memory storage or access may be done randomly or sequentially. Non-volatile memory is included so that all memories are retained even when line power is removed.

The HP 8350B makes "simultaneous" comparison of two separate frequency ranges or power levels easy via the alternate sweep mode. When the alternate sweep mode is activated the 8350B alternates between the current front panel setting and any stored memory setting on successive sweeps. The output from this function may be processed through a network analyzer such as the HP 8756A and viewed on a two channel display.

All front panel controls (except the ac line power switch) may be programmed or controlled via the HP-IB. The 8350B may interact as a listener or as a talker on the HP-IB. As a talker the 8350B is capable of outputting the manually entered front panel information to a controller. The HP-IB capabilities of the 8350B are far more extensive than in other sweepers hence increasing its range of applications.

As a result of the 8350's internal microprocessor design, a self test is performed at turn on or whenever the instrument pre-set function is activated. This function verifies that the 8350B is functioning properly. If there is a problem, error codes are displayed on the front panel to help locate the problem quickly to the board and component level.

In the 8350B the frequency resolution is determined by the digital to analog converters that are used to produce the tuning voltage and marker pulses. The center frequency resolution is 0.00038% of the full band (262,144 points across the band). The ΔF resolution is variable, such that higher resolution is provided for narrow sweep widths. The ΔF resolution is 0.1% of the full band range for full bands sweeps and improves to 0.0015% of the full band range for very narrow band sweeps.



8350B Specifications

Instrument Control

Control knobs, step keys and data entry keyboard: all instrument parameters whether time, frequency or power may be set three ways: control knobs, keyboard entry, or step keys. The step size either can be entered by the user or the pre-programmed default values may be used. The SHIFT key is used to effect the functions written in blue.

Frequency Control Functions

Range: determined by RF plug-in unit used

Linearity: refer to RF unit specifications

START/STOP sweep: sweeps up from the START frequency to the STOP frequency.

CF/ΔF Sweep: sweeps symmetrically upward, centered on CF

ΔF: frequency Width of sweep. Continuously adjustable from zero to 100% of frequency range.

ΔF Accuracy: refer to RF unit specifications.

CF Accuracy: refer to RF unit specifications.

CF Resolution: 0.00038% (262,144 points across band)

ΔF Resolution: 0.1% of full band (1024 points across band)

0.012% of band for 1/4 of band or less

0.0015% of band for 1/16 of band or less

Display resolution: 5 digits

CW operation: single frequency RF output.

CW accuracy: refer to RF unit specifications.

CW resolution: same as CF.

Vernier: adjusts CW frequency or swept center frequency up to 0.05% of RF plug-in band being swept.

Vernier resolution: 4 ppm (64 points between each CW point; 262,144 points across band)

Offset: allows the CW frequency or center frequency to be offset by any amount up to the full range of the plug-in.

Resolution: same as CF

Accuracy: refer to RF unit specifications

Frequency markers: five frequency markers are independently adjustable and fully calibrated over the entire sweep range. Amplitude or intensity markers available.

Resolution: 0.4% of selected sweep width (256 points/sweep)

Accuracy: refer to frequency accuracy.

Marker output: rectangular pulse, typically -5 volts peak available from the POS Z BLANK connector on rear panel.

Marker sweep: RF output is swept between Marker 1 and Marker 2.

Marker—CF: causes the CW or the swept center frequency to equal the frequency of the active marker.

Sweep and Trigger Modes

Internal: sweep recurs automatically

Line: sweep triggered by ac power line frequency.

External trigger: sweep is actuated by external trigger signal.

Single: selects mode and triggers a single sweep.

Sweep time: continuously adjustable from 10 msec to 100 seconds.

Manual sweep: front panel controls provide continuous manual adjustment of frequency between end frequencies.

External sweep: sweep is controlled by external signal applied to front or rear panel SWP OUTPUT/SWP INPUT connector.

Sweep output: direct-coupled sawtooth, zero to approximately ± 10 volts, at front or rear panel concurrent with swept RF output.

Instrument State Storage

Save n/recall n: up to 9 different front panel settings can be stored in the 8350B via the Save n (n = 1 through 9) function. Settings can be recalled randomly or in sequence.

Alt n: causes the RF output to alternate on successive sweeps between the current front panel setting and a setting stored in memory.

Instrument State

Instrument preset: sets the front panel of the 8350B into a pre-determined state. It also causes an internal analog and digital self-test to occur. If internal errors or failures are detected they are indicated via error codes.

Local operation: this key is used to return the 8350B to local control from the remotely controlled state. The REM lamp indicates remote control. The ADRS'D lamp indicates transmitted or received data over the HP-IB.

Modulation

External AM: refer to RF unit specifications.

Internal AM: square wave modulation available at all sweep speeds. Factory preset to 27.8 kHz although selectable to 1000 Hz or 27.8 kHz. On/off ratio, refer to RF unit specifications.

External FM: refer to RF unit specifications.

Phase-lock: refer to RF unit specifications.

Remote Programming (HP-IB)

The 8350B has both input and output capability. The HP-IB address can be displayed on the front panel and is selectable (any number from 0 to 31).

Input mode functions: all front panel controls except the ac line power switch are programmable. Numerical values typically have greater entry resolution than is displayed.

Frequency resolution: same as CF/ΔF plus vernier.

Power resolution: see 83500 Series Plug-ins.

Output mode functions: the 8350B can output to a controller an instrument state message that describes the present instrument status.

General Specifications

Non volatile memory: continuous memory that retains the contents of all instrument state storage registers, the HP-IB address, and current instrument state when ac line power is off.

Blanking

RF: when enabled, RF turns off during retrace and remains off until next sweep.

Display: POS Z BLANK; direct-coupled rectangular pulse approximately +5.0 volts during retrace and bandswitch points of sweep. NEG Z BLANK; direct-coupled rectangular pulse approximately -5.0 volts coincident in time with RF blanking.

Pen Lift: output to control the pen lift function of XY recorder at end point of sweep.

Counter trigger (CNTR TRIG): output for controlling the external trigger input of the HP 5343A Frequency Counter.

Stop sweep: input for stopping the progress of a forward sweep, used with HP 5343A Frequency Counter.

Program connector: additional control of and information on the 8350B instrument state is provided via a 25 pin rear panel connector.

8410B/C interface cable: permits multi-octave operation of HP 8410B/C Network Analyzer with 8350B.

Operating temperature range: 0°C to +55°C

Power: 100, 120, 220 or 240 volts ± 10%, 50 to 60 Hz (Option 400, 60 to 400 Hz). Approximately 270 volt-amps including RF unit.

Weight (not including RF unit): Net 16.5 kg (36.4 lb). Shipping 22.7 kg (50 lb)

Dimensions: 425 mm wide, 133.3 mm high, 422 mm deep (16.75" x 5.25" x 16.6")

Ordering Information

8350B Sweep Oscillator Mainframe

Options

400: 400 Hz Power Line Frequency Operation

803: HP 5343A Interface Cables

850: HP 8410B/C Source Control Cable

907: Front Handles Kit

908: Rack Mounting Kit

909: Rack Mounting/Front Handles Kit

910: Extra Manual

SWEEP OSCILLATORS

8350 Series: Broadband RF Plug-Ins

Models 83595A, 83592A/B/C, 83594A, 83590A

- Calibrated output power with 0.1 dB resolution
- +13 dBm from 0.01 to 18.6 GHz
- 12 MHz frequency accuracy at 26.5 GHz

- -55 dBc harmonics and subharmonics from 2 to 20 GHz
- Internal leveling and slope standard
- HP-IB

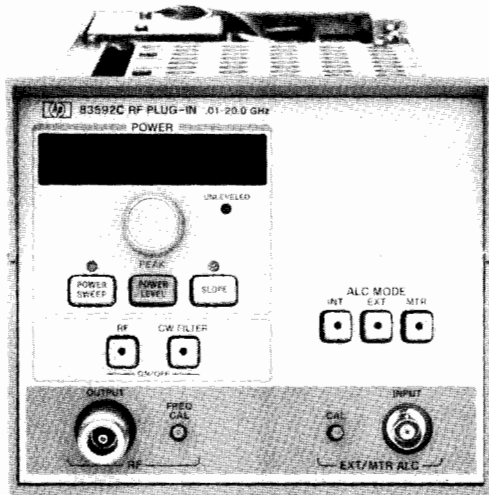

83592C



The six 83590 series plug-ins feature ultra-wideband frequency coverage as exemplified by the 83595A which covers 0.01–26.5 GHz in a single sweep. While the 83590 series features broadband sweeps, they still maintain narrowband precision. The frequency output exhibits excellent stability and accuracy. At 26.5 GHz the 83595A maintains an accuracy of ± 12 MHz. The 83592B does not sacrifice power for broadband high frequency coverage, the output power is internally leveled for a minimum +13 dBm (to 18.6 GHz) output with ± 0.9 dB flatness. The 83592C provides a clean test signal with -55 dBc harmonic and subharmonic levels to maximize the dynamic range. Power output capabilities have been expanded to provide power sweep and slope control. In addition the 83590 series plug-ins are completely HP-IB programmable.

The most outstanding feature of the 83590 series plug-ins is their broad frequency range. Innovative technology is used to create this precision frequency range. The principle behind this technology is the Switched YIG Tuned Multiplier circuit (SYTM). The YTM circuit uses the output of a fundamental oscillator to drive a high-efficiency multiplier that has been integrated together with a tracking YIG filter in order to create and select high order harmonics to be used as output frequencies.

A figure of merit for the 83590 series are their flat output power over the entire frequency range. The output power is internally leveled within 0.9 dB for a minimum output power of 10 dBm, with a displayed resolution of 0.1 dB. The power level may be controlled to a minimum settable power level of -5 dBm. This level may be extended to -75 dBm on the 83592A/B and 83590A with Option 002 (70 dB Step Attenuator) or to -60 dBm on the 83592C, the 83595A and 83594A with Option 002 (55 dB Step Attenuator).

Since power parameters are critical to high frequency measurements the 83590 Series (along with all 83500 series plug-ins) offer many modes of power output. In addition to a single power output, the 83590 Series offers a Power Sweep function. The Power Sweep function sweeps a power range for characterizing level sensitive devices like amplifiers and transistors. The Slope mode is also supplied to provide compensation for cable or test set losses. In all these modes the power output is internally monitored and leveled. If preferred, the power may be externally leveled.

HP-IB programmability is an essential feature when one of the 83590 series is used in automatic test systems. For example, the automated tests of amplifiers for gain compression are possible. These plug-ins are completely programmable which means the power mode may be selected, and the power level may be set with .02 dB resolution.

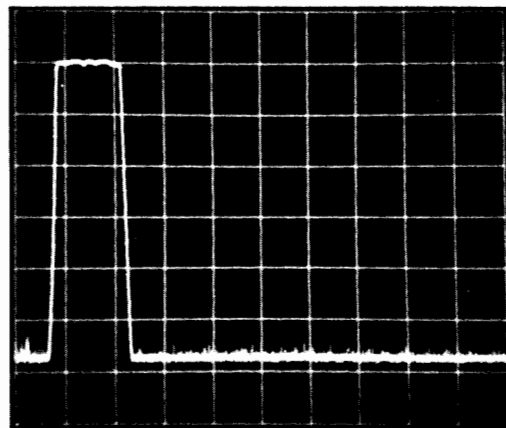

2.0 GHz

1.8 GHz/DIV

20.0 GHz

General Specifications

Sweep time (minimum): 10 msec for a single band (Bands 0, 1, 2, 3, 4). 25 msec for full band (83590A, 83592A/B).

Switch points: 83595A, 83592A/B: Internal bands are 0.01–2.4 GHz, 2.3–7.0 GHz, 6.9–13.5 GHz, 13.4–20.0 GHz and 19.9–26.5 GHz (83595A only). Broadband switch points are at approximately 2.4 GHz, 7.0 GHz, 13.5 GHz and 20.0 GHz (83595A only). 83594A, 83590A: Internal bands are 2.0–7.0 GHz, 6.9–13.5 GHz, 13.4–20.0 GHz and 19.9–26.5 GHz (83594A only). Broadband switch points are at approximately 7.0 GHz, 13.5 GHz and 20.0 GHz (83594A only).

Auxiliary output: 83595A, 83592A/B: Rear Panel 2.3–7.0 GHz fundamental oscillator output, nominally 0 dBm. 83592C, 83594A, 83590A: Rear Panel 2.0–7.0 GHz fundamental oscillator output, nominally 0 dBm.

Frequency reference output: 83595A, 83592A/B/C: nominal 1V/GHz (0.01–19 GHz) ± 20 mV rear panel BNC output. 83594A, 83590A: nominal 1V/GHz (2–19 GHz) ± 20 mV rear panel BNC output.

RF output connector: 83595A, 83594A: Type APC 3.5 male. 83592A/B/C, 83590A: Type N female.

Weight: Net 6.0 kg (13.2 lb.) Shipping 9.2 kg (20 lb.)

Improved Network Measurement Capabilities

These plug-ins are compatible with the:

- 8410 Network Analyzer
- 8756A Scalar Network Analyzer
- 8970A Noise Figure Meter
- 8709A Phase-Lock Synchronizer
- 5344S Source Synchronizer

Output Characteristics

Impedance: 50 Ω nominal

VSWR: <1.9:1

Power Sweep (with option 002 Power Sweep cannot cross an attenuator step)

Calibrated range: 83590A, 83592A/B/C: >10 dB (15 dB typical); 83594A, 83595A: 9 dB

Accuracy (including linearity): < ± 1.5 dB typical

Resolution: 0.1 dB

Slope Compensation (with option 002 Slope cannot cross an attenuator step)

Calibrated range: up to .5 dB/GHz (10 dB over full range)

Linearity: <.3 dB typical

Resolution: 0.1 dB/GHz

Attenuator Accuracy (\pm dB referenced from the 0 dB setting, 83590A, 83592A/B only)

Frequency Range (GHz)	Attenuator Setting (dB)						
	10	20	30	40	50	60	70
0.01-12.4	0.6	0.7	0.9	1.8	2.0	2.2	2.3
12.4-18.0	0.7	0.9	1.2	2.0	2.3	2.5	2.8
18.0-20.0	0.9	1.5	2.5	3.0	3.2	3.3	3.5

Modulation Characteristics

External AM

Frequency response: typically 100 kHz

Input impedance: approximately 10 k Ω

Range of amplitude control: typically 15 dB

Sensitivity: 1 dB/V typical

Maximum input: 15 V

Pulse In (83595A and 83592A/B/C only)

TTL Compatible: Logic high = RF on, Logic low = RF off.

0.01 to 20.0 GHz: Squarewave modulation up to 30 kHz.

0.01 to 2.5 GHz

Rise/Fall Time: typically 50 ns.

Minimum Pulse Width

Leveled: 5 μ sec.

Unleveled: Typically 200 ns.

2.5 to 20 GHz

Rise/Fall Time: Typically 10 ns.

Minimum Pulse Width

Leveled: Typically 5 μ sec.

Unleveled: Typically 100 ns.

External FM

Maximum Deviations for Modulation Frequencies

DC to 100 Hz: \pm 75 MHz

100 Hz to 1 MHz: \pm 7 MHz

1 MHz to 2 MHz: \pm 5 MHz

2 MHz to 10 MHz: \pm 1 MHz

Sensitivity

FM Mode: -20 MHz/V typical

Phase-lock mode: -6 MHz/V typical

Input impedance: 2 k Ω nominal

Frequency response: (DC to 2 MHz): \pm 3 dB

Ordering Information

83590A 2.0 to 20 GHz RF Plug-in

Option 002: 70 dB Step Attenuator

Option 004: Rear Panel RF Output

83592A 0.01 to 20 GHz RF Plug-in

Option 002: 70 dB Step Attenuator

Option 004: Rear Panel RF Output

83592B 0.01 to 20 GHz (13 dBm) RF Plug-in

Option 002: 70 dB Step Attenuator

Option 004: Rear Panel RF Output

83592C 0.01 to 20 GHz (-55 dBc harmonics) RF

Plug-in

Option 002: 55 dB Step Attenuator

Option 004: Rear Panel RF Output

83594A 2.0 to 26.5 GHz RF Plug-in

Option 002: 55 dB Step Attenuator

Option 004: Rear Panel RF Output

83595A 0.01 to 26.5 GHz RF Plug-in

Option 002: 55 dB Step Attenuator

Option 004: Rear Panel RF Output

	83592A/B/C 83590A (excluding Band 0)					83595A 83594A (excluding Band 0)					
	Band ^A 0	Band ^A 1	Band 2	Band 3	Full ^A Band	Band 0	Band ^A 1	Band 2	Band 3	Band 4	Full ^A Band
Frequency Characteristics Accuracy: (25°C \pm 5°C)	.01-2.4	2.4-7.0	7.0-13.5	13.5-20	.01-20	.01-2.4	2.4-7.0	7.0-13.5	13.5-20	20-26.5	.01-26.5
CW Mode: (MHz)	\pm 5	\pm 5	\pm 10	\pm 10		\pm 5	\pm 5	\pm 10	\pm 10	\pm 12	
Typically: (MHz)	\pm 2	\pm 2	\pm 3	\pm 4		\pm 2	\pm 2	\pm 3	\pm 4	\pm 5	
All Sweep Modes (100msec Sweep Time): (MHz)	\pm 15	\pm 20	\pm 25	\pm 30	\pm 50	\pm 15	\pm 20	\pm 25	\pm 30	\pm 35	\pm 50
Linearity: Typ. (MHz)	\pm 2	\pm 2	\pm 4	\pm 6	\pm 10	\pm 2	\pm 2	\pm 4	\pm 6	\pm 10	\pm 15
Stability											
With Temperature: Typically (MHz/ $^{\circ}$ C)	\pm 2	\pm 2	\pm 4	\pm 6	\pm 6	\pm 2	\pm 2	\pm 4	\pm 6	\pm 8	\pm 8
With 10% Line Voltage Change: (kHz)	\pm 50	\pm 50	\pm 100	\pm 150	\pm 150	\pm 50	\pm 50	\pm 100	\pm 150	\pm 200	\pm 200
With 10 Power Level Change: (kHz)	\pm 200	\pm 200	\pm 400	\pm 600	\pm 600	\pm 200	\pm 200	\pm 400	\pm 600	\pm 800	\pm 800
With 3:1 Load VSWR: (kHz)	\pm 100	\pm 100	\pm 200	\pm 300	\pm 300	\pm 100	\pm 100	\pm 200	\pm 300	\pm 400	\pm 400
With Time (after 1 hour warmup at the same frequency)											
Typically (kHz)	<200	<200	<400	<600	<600	<100	<100	<200	<300	<400	<400
Residual FM (10 Hz-10kHz bandwidth, peak): (kHz)	<8	<5	<7	<9		<5	<5	<7	<9	<12	
Output Characteristics											
Maximum Leveled Power ^D : (mW) (25°C)	10,(20) ^B	10,(20), ^B (4) ^C	10,(20), ^B (4) ^C	10,(2.5) ^C	10,(2.5) ^C	10	10	10	10	2.5	2.5
Opt 002	10,(16) ^B	7,(14), ^B (2.8) ^C	6.3,(14) ^B , ^B (2.5) ^C	5,(1.25) ^C	3.2,(1.25) ^C	10	7	6.3	5	1.25	1.25
Power Level Accuracy											
(Internally Leveled): (dB)	< \pm 1.5	< \pm 1.3	< \pm 1.3	< \pm 1.4	< \pm 1.5	< \pm 1.5	< \pm 1.3	< \pm 1.3	< \pm 1.4	< \pm 1.7	< \pm 1.8
Minimum Settable Power: (dBm)	-5	-5	-5	-5	-5	-5	-5	-5	-5	-5	-5
With Opt 002	-75,(-60) ^C	-75,(-60) ^C	-75,(-60) ^C	-75,(-60) ^C	-75,(-60) ^C	-60	-60	-60	-60	-60	-60
Remote Programming Resolution Displayed: (dB)	.1	.1	.1	.1	.1	.1	.1	.1	.1	.1	.1
Settable (dB)	.02	.02	.02	.02	.02	.02	.02	.02	.02	.02	.02
Power Variation (Max. Rated Pwr)											
Internally Leveled: (dB)	< \pm 9	< \pm 7	< \pm 7	< \pm 8	< \pm 9	\pm 9	\pm 7	\pm 7	\pm 8	\pm 9	\pm 10
Externally Leveled (Excludes Coupler/Detector Variation)											
(For Negative Crystal Detector and HP 432A/B/C Power Meter): (dB)	< \pm 2	< \pm 2	< \pm 2	< \pm 2	< \pm 2	< \pm 2	< \pm 2	< \pm 2	< \pm 2	< \pm 2	< \pm 2
With Temperature: (dB/ $^{\circ}$ C)	.1	.1	.1	.1	.1	.1	.1	.1	.1	.1	.1
Residual AM in 100 kHz Bandwidth: (dBc)	>50	>50	>50	>50	>50	>50	>50	>50	>50	>50	>50
Spurious Signals											
Harmonically Related: (dBc)	>25,(20) ^B	>25,(>55) ^C	>25,(>55) ^C	>25,(>55) ^C	>25	>25	>25	>25	>25	>20	>20
Typically: (dBc)	>35	>40,(>60) ^C	>35,(>60) ^C	>35,(>60) ^C	>35	>35	>40	>35	>35	>35	>35
Non-Harmonics: (dBc)	>25	>50,(>55) ^C	>50,(>55) ^C	>50,(>55) ^C	>25	>25	>50	>50	>50	>50	>50

^A Band 0 on the 83592C covers 0.01-2.1 GHz; Band 1 on the 83590A, the 83592C, and the 83594A covers 2.0-7.0 GHz, and Full Band on the 83590A and 83594A covers 2-20 GHz and 2-26.5 GHz.

^B 83592B only.

^C 83592C only.

^D 0.5 dB lower with Opt 004.



SWEEP OSCILLATORS

8350 Series: Broadband RF Plug-Ins (cont.)

Models 83522A, 83525A and 83525B

- 10 MHz–2.4 GHz and 10 MHz–8.4 GHz in one continuous sweep
- Calibrated output power
- Power sweep

- 1, 10, and 50 MHz crystal markers
- >45 dBc harmonics 83525B from 2–8.4 GHz output
- Complete HP-IB programmability

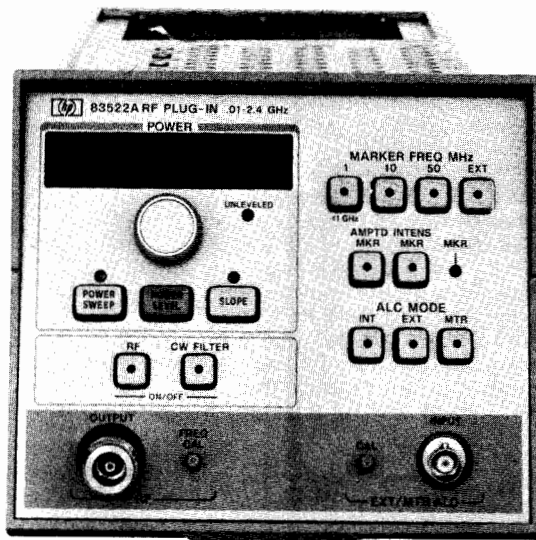

83522A

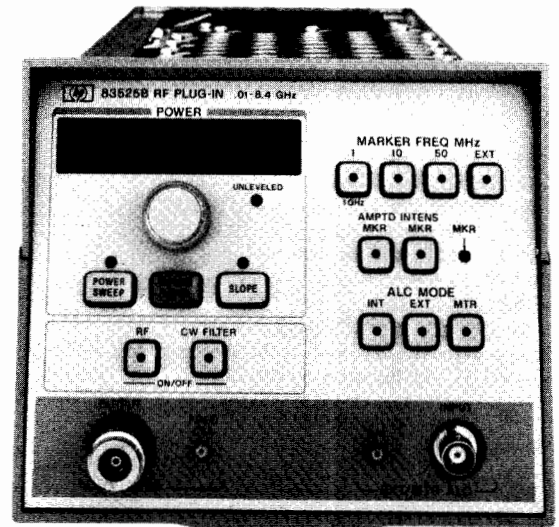

83525B



Broadband frequency measurements may be made with the HP83522A (10 MHz to 2.4 GHz) plug-in and the HP 83525A/B (10 MHz to 8.4 GHz) plug-in. These plug-ins have similar functions as well as individual merits which are all described in the following article.

83522A

The 83522A uses a heterodyne circuit to provide high performance 10 MHz to 2.4 GHz frequency coverage. This frequency range is covered in one continuous sweep having excellent frequency characteristics. Frequency accuracy is maintained within 5 MHz and the linearity is within 2 MHz over the full band. The power output is internally leveled to ± 0.25 dB flatness over the entire 10 MHz to 2.4 GHz range while maintaining a power level ≥ 13 dBm.

83525A/B

The 83525A/B cover the unmatched frequency range of 10 MHz to 8.4 GHz with excellent frequency stability, accuracy, and output power. This wide frequency range is created by automatically switching two bands together with a PIN diode switch. The lower frequency band covers 0.01–2.1 GHz which results from a heterodyne circuit. The upper frequency band is produced by a 2–8.4 GHz YIG oscillator. This 0.1 GHz frequency overlap is provided to enable smooth, narrowband sweeps around the switch point. On a full band sweep (10 MHz to 8.4 GHz) the band discontinuity at the switchpoint will be typically < 8 MHz. The 83525A/B maintain excellent frequency parameters with a lower band accuracy within ± 5 MHz and an upper band accuracy within 8 MHz. Full band frequency linearity is ± 3 MHz while the lower band maintains a linearity of ± 2 MHz.

The 83525A plug-in, with its extremely broad frequency range, does not sacrifice power. This plug-in provides at least +13 dBm of output power while being internally leveled to a flatness of ± 1 dBm.

The 83525B plug-in provides the same outstanding specifications as the 83525A plus 45 dBc harmonics for maximum dynamic range in RF component and system measurements.

83522/83525 Common Features

Crystal Marker Capability

A powerful feature offered by the 83522A and the 83525A/B is Crystal Marker capability. This capability provides harmonic markers at 10 or 50 MHz intervals over the full range of the 83522A and below 2 GHz with the 83525A/B. In addition, 1 MHz harmonic markers are available below 1 GHz with all three plug-ins. These

markers may either be seen as intensity spots or amplitude dips. The x-axis intensity markers are compatible with the HP8755 Swept Frequency Response Test Set. These crystal markers simplify and speed up precision frequency measurements.

Power Output

The 83522A and the 83525A/B plug-ins have a calibrated output power range of typically 15 dB that may be extended to > 80 dB with Option 002 (70 dB attenuator). The output power level accuracy is within 1 dB on the 83522A and within 1.5 dB on the 83525A/B. The front panel digital resolution enables the power to be manually set to a 0.1 dB resolution. The power may be remotely HP-IB programmed to 0.02 dB resolution.

These plug-ins also offer a variety of power functions. An innovative feature offered on these plug-ins is Power Sweep, which sweeps the output power from one level to another. With this function, power response measurements may be made in a single test. Slope compensation is provided for situations that involve lossy cables or test set ups. This function slopes the power to compensate for high frequency losses via a "Slope" control.

Programmability

The 83522A and the 83525A/B are completely programmable plug-ins. This infers that the power level, power mode (Power Sweep, Slope, etc.), crystal markers and other plug-in functions may be externally controlled via the HP-IB. Programmability is a key feature for automatic test systems or production environments requiring multiple, repetitive tests.

Network Measurements

Increased dynamic range scalar measurements can be made using either the HP83522A or the 83525A with the HP 8756A Scalar Network Analyzer. The dynamic range is increased by internally modulating the RF output with the required 27.8 KHz square wave (produced by the 8350). This causes the output to be modulated before it is passed through the output amplifier, thereby avoiding modulation of the amplifier noise. The advantage of increased dynamic range is complemented by the simple interface between the sweep oscillator and the HP 8756A. In addition these plug-ins are directly compatible with the HP 8410 Network Analyzer for vector measurements, the HP 8970A Noise Figure Meter for noise level analysis and the HP 5344S Source Synchronizer for phase-lock applications.

Frequency Characteristics

Range	83522A	83525A/B	
	0.01-2.4 GHz	0.01-2 GHz	2-8.4 GHz
Accuracy* (25°C ± 5°C)			
CW Mode:	± 5 MHz	± 5 MHz	± 8 MHz
Typically:	± 1.5 MHz	± 1.5 MHz	± 3.5 MHz
All Sweep Modes	± 15 MHz	± 15 MHz	± 20 MHz
Linearity Typically:	± 2 MHz	± 2 MHz	± 3 MHz
Stability			
With Temperature: Typically	± 200 kHz/°C	± 200 kHz/°C	± 200 kHz/°C
With 10% Line Voltage Change:	± 20 kHz	± 20 kHz	± 20 kHz
With 10 dB Power Level Change:	± 100 kHz	± 100 kHz	± 1 MHz
With 3:1 Load SWR:	± 10 kHz	± 10 kHz	± 250 kHz
With Time (in 10 minute period after one hour warmup at the same frequency setting):	< ± 100 kHz	< ± 100 kHz	< ± 200 kHz
Residual FM (10 Hz-10 KHz Bandwidth), peak	< 5 kHz	< 5 kHz	< 9 kHz

Output Characteristics

	83522A	83525A/B	
	0.01-2.4 GHz	0.01-2 GHz	2-8.4 GHz
Maximum Leveled Output Power (25°C ± 5°C) With Option 002	+20 mW +20 mW	+20 mW +20 mW	+20 mW/10 mW +16 mW/10 mW
Power Level Accuracy (Internally Leveled):	± 1 dB	± 1.5 dB	± 1.5 dB
Calibrated Range:	15 dB	15 dB	15 dB
With Option 002:	85 dB	85 dB	85 dB
Attenuator Accuracy (per 10 dB step, typical):	± 0.5 dB	± 0.5 dB	± 0.5 dB
Resolution (displayed):	0.1 dB	0.1 dB	0.1 dB
Remote Programming (Settable):	± 0.01 dB	± 0.01 dB	± 0.01 dB
Power Variation (Max. Rated Pwr)			
Internally Leveled:	± 0.25 dB	± 1 dB	± 1 dB
Externally Leveled (Excludes Coupler/Detector Variation)			
For Negative Crystal Detector and HP 432A/B/C Power Meter:	< ± 0.1 dB	< ± 0.1 dB	< ± 0.1 dB
With Temperature:	± 0.02 dB/°C	± 0.02 dB/°C	± 0.02 dB/°C
Residual AM in 100 kHz Bandwidth:	> 50 dBc	> 50 dBc	> 50 dBc
Spurious Signals			
Harmonics (for 10 mW output pwr):	> 25 dBc	> 25 dBc**	> 25 dBc/ 45 dBc
Typical:	> 30 dBc	> 30 dBc	> 30 dBc/50 dBc
Non-Harmonics:	> 25 dBc	> 30 dBc	> 60 dBc
Typical:	> 30 dBc	> 35 dBc	> 60 dBc
Output VSWR (internally leveled)	< 1.5	< 2.0	< 1.6

Unleveled indicator: lights when RF power level is set too high to permit leveling over sweep range selected.

Impedance: 50 Ω nominal

Power Sweep

Calibrated range: 15 dB

Accuracy (including linearity): < ± 1.5 dB typical

Resolution: 0.1 dB

Slope Compensation

Calibrated range: up to 5 dB/GHz (10 dB over full range, typically 15 dB)

Linearity: < 0.2 dB typical

Resolution: 0.01 dB/GHz

Modulation Characteristics

External AM

Frequency response: 100 kHz typically

Input impedance: Approximately 10 kΩ

Range of amplitude control: 15 dB typically

Sensitivity: 1 dB/V typically

Maximum input: 15 V

Pulse modulation: (83525A/B, 2-8.4 GHz)

Rise/fall time: 20 nsec typically

Minimum pulse width: Leveled: 1 μsec Typically

Unleveled: 100 nsec Typically

*When calibrated using internal crystal markers and FREQ CAL adjustment.

**83525A harmonics > 20 dBc for 20 mW output power.

Internal AM

Selectable (by Internal Jumper in 8350A) to 1 kHz or 27.8 kHz square wave modulation. 27.8 kHz Modulation guarantees operation with HP 8755 Frequency Response Test Set.

On/Off Ratio: ≥ 30 dB (> 40 dB above 2 GHz)

External FM

Maximum Deviations for Modulation Frequencies

DC to 100 Hz: ± 75 MHz

100 Hz to 1 MHz: ± 7 MHz

1 MHz to 2 MHz: ± 5 MHz

2 MHz to 10 MHz: ± 1 MHz

Sensitivity

FM Mode: -20 MHz/V typical

Phase-lock mode: -6 MHz/V Typical

Input impedance: 2 kΩ nominal

Frequency response (dc to 2 MHz): ± 3 dB

Crystal Marker Capability

Internal crystal markers: Harmonic markers of 10 and 50 MHz are available over the full range of the 83522A and below 2 GHz with 83525A/B. 1 MHz harmonic markers are available below 1 GHz with the 83522A and 83525A/B. Markers are output as intensity spots through the POS Z BLANK connector on the 8350 or as amplitude dips on the RF output.

Accuracy of center frequencies (25°C): ± 5 x 10⁻⁶

Typical Marker Width Around Center Frequency

1 MHz Markers: ± 100 kHz

10 MHz Markers: ± 200 kHz

50 MHz Markers: ± 300 kHz

Temperature stability: ± 2 x 10⁻⁶/°C Typical

External marker input: generates amplitude or Z-axis marker when sweep frequency equals external input frequency.

Frequency range: .01 to 2.4 GHz (2.0 GHz for 83525A/B)

Marker width: ± 300 kHz

Marker indicator light: LED lights when coincident with crystal or external marker for accurate CW calibration.

General Specifications

Sweep Time (minimum over full band)

83522A (.01-2.4 GHz): 10 ms

83525A/B (.01-8.4 GHz): 17 ms

Switch points (83525A/B only): low Band .01-2.1 GHz, High Band 2.0-8.4 GHz. Internal band switch point at 2.0-2.1 GHz

Frequency reference output: nominal 1 V/GHz (over full sweep range) ± 10 mV rear panel BNC output.

RF Output connector: type N female

Weight: net 4.5 kg. (10 lb.). Shipping 7.7 kg. (17 lb.)

Improved Network Measurement Capabilities

The 83522A and 83525A/B are compatible with the:

8410 Network Analyzer

8755 Scalar Network Analyzer

8970A Noise Figure Meter (Frequencies > 2 GHz)

8709A Phase-lock Synchronizer

5344S Source Synchronizer

Ordering Information

83522A +13 dBm .01-2.4 GHz RF Plug-in

Options:

002: Programmable 70 dB Step Attenuator (10 dB steps)

004: Rear Panel RF Output

83525A +13 dBm .01-8.4 GHz RF Plug-in

83525B +10 dBm .01-8.4 GHz RF Plug-in

Options:

002: Programmable 70 dB Step Attenuator (10 dB steps)

004: Rear Panel RF Output

SWEEP OSCILLATORS

8350 Series: RF Plug-Ins

Models 83540A, 83540B and 83545A

- 83540A offers 40 mW internally leveled 2-8.4 GHz output
- 83545A offers 50 mW internally leveled 5.9-12.4 GHz output
- 83540B offers >45 dBc harmonics 2-8.4 GHz output
- Calibrated output power with 0.1 dB resolution
- Power sweep
- Complete HP-IB programmability

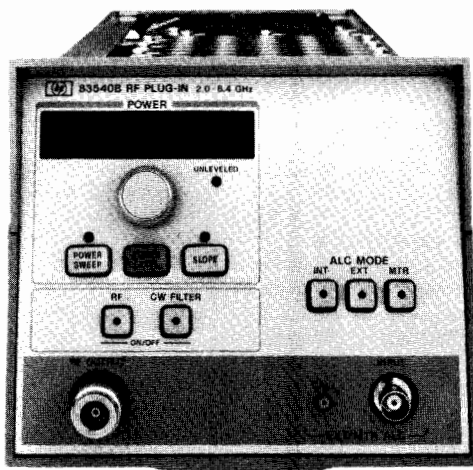

83540B

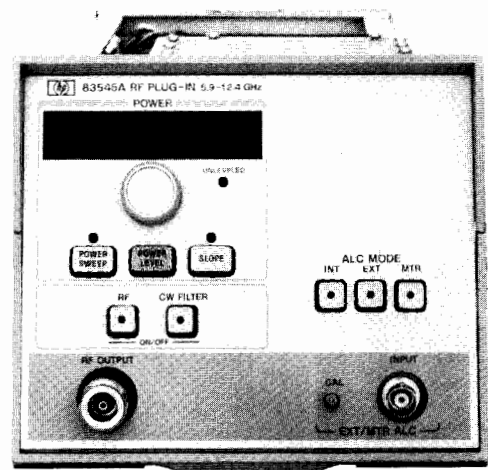

83545A



83540A/B

High power, high performance, straddle band frequency coverage from 2-8.4 GHz is provided by the 83540 plug-ins. The output power is leveled at a minimum of 16 dBm from the 83540A and 13 dBm from the 83540B with variations less than 1 dB. The calibrated power output range is 15 dB which may be extended to >80 dB with Option 002 (70 dB Step Attenuator). These plug-ins also feature Power Sweep which allows realtime power response measurements to be made in a single test. Another power function is slope compensation which adjusts for high frequency cable or test set losses. All plug-in features are completely HP-IB programmable. The frequency outputs are accurate within 8 MHz while maintaining a full band linearity typically within 0.1%. In addition to its sweeper functions, the 83540 is also directly compatible with the HP 8755 Swept Frequency Response Test Set and the HP 8410B/C Network Analyzer.

The 83540B gives emphasis to signal purity with 45 dBc harmonics for extended dynamic range in precision RF scalar measurement systems.

The clear, high power test signal of the 83540B is produced by employing a YIG-filtered oscillator (YFO). The YFO consists of a broadband, YIG tuned 2-8.4 GHz oscillator driving a 100 mW power amplifier followed by another YIG element to filter the signal. By incorporating both YIG elements within the same magnetic housing and controlling them simultaneously, a very accurate, pure and powerful RF test signal is achieved.

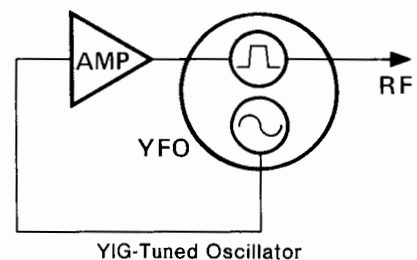



83545A

The 83545 plug-in features high performance 5.9-12.4 GHz frequency coverage with exceptionally high output power. The output power is internally leveled to at least 17 dB, with power variations less than 0.6 dB! The calibrated output power has a range of 15 dB which is expandable to >80 dB with Option 002 (70 dB Step Attenuator). A power sweep function is available for power response measurements. In addition, the 83545 provides slope compensation and complete HP-IB programmability. The frequency output is accurate to 20 MHz with excellent stability and linearity (typically 0.1%). Network analysis is simplified since the 83545 provides 27.8 kHz internal modulation for direct compatibility with the HP 8756A Scalar Network Analyzer and it is also directly compatible with the HP 8410B/C Network Analyzer.

Frequency Characteristics

Linearity: (83540A/B, 83545A) $\pm 0.1\%$ typical

Reference output: (83540A, 83545A) dc-coupled voltage proportional to RF frequency. Typically 1V/GHz with accuracy of ± 25 mV.

Output Characteristics

Power level accuracy: ± 1 dB typical

Option 002 (70 dB step attenuator): (83540A, 83545A) ± 0.2 dB/10 dB step typical

RF Power Leveling

Internal: Selected by front panel switch; Refer to chart for figures. Standard for 83540 and 83545.

External

Crystal input: approximately -20 to -250 mW for specified leveling at rated output; For use with negative polarity detectors such as 780 Series Directional Detectors, 423A/B and 424 Series Crystal detectors.

Power meter input: switch selects proper compensation for HP 432A/B/C Power Meters.

Indicator: front panel indicator lights when RF power becomes unlevelled. Residual AM in 100 kHz Bandwidth: >50 dBc

Impedance: 50 Ω nominal

Power Sweep

Calibrated range: ≥ 15 dB

With option 002: ≥ 14 dB

Accuracy: ± 1.5 dB typical

Resolution: 0.1 dB

Slope compensation: compensates for high frequency power losses in external test sets by attenuation power at lower frequencies:

Calibrated range: up to 5 dB/GHz (10 dB max., typically 15 dB)

Linearity: <0.2 dB typical

Resolution: 0.01 dB/GHz

General Specifications

RF output connector: type N female

Sweep Time (minimum over full band)

83540A/B (2.0-8.4 GHz): 10 ms

83545A (5.9-12.4 GHz): 10 ms

Weight: 83540A, 83545A: Net 4.5 kg (10 lbs). Shipping 7.7 kg (17 lbs).

Improved Network Measurement Capabilities

The 83540A/B and 83545A are compatible with the:

8410 Network Analyzer

8755 Frequency Response Test Set

8756A Scalar Network Analyzer

8970A Noise Figure Meter

8709A Phase-lock Synchronizer

5344S Source Synchronizer

Frequency Characteristics

	83540A	83540B	83545A
Range:	2-8.4 GHz	2-8.4 GHz	5.9-12.4 GHz
Accuracy (25°C \pm 5°C)			
CW Mode:	± 15 MHz	± 12 MHz	± 20 MHz
Typical:	± 3.5 MHz	± 3.5 MHz	± 10 MHz
All Sweep Modes: (for sweep time >100 msec)	± 20 MHz	± 20 MHz	± 35 MHz
Stability			
With Temperature:	± 200 kHz/°C	± 200 kHz/°C	± 1.2 MHz/°C
With 10% Line Voltage Change:	± 20 kHz	± 20 kHz	± 40 kHz
With 10 dB Power Level Change:	± 1 MHz	± 1 MHz	± 1.5 MHz
With 3:1 Load SWR Change:	± 250 kHz	± 250 kHz	± 250 kHz
With Time: (in 10 minute time period after one hour warmup at the same frequency setting) Typ./10 min.	± 200 kHz	± 200 kHz	± 200 kHz
Residual FM: (in 10 Hz-10 kHz bandwidth, CW mode):	<9 kHz peak	<7 kHz	<15 kHz peak

Output Characteristics

	83540A	83540B	83545A
Maximum Levelled Power (25°C \pm 5°C Opt 002 (70 dB step atten.))	>40 mW >32 mW	>20 mW >16 mW	>50 mW >40 mW
Power Variation (At max. rated power)			
Internally Levelled:	< ± 1 dB	< ± 1 dB	< ± 0.6 dB
Unlevelled: Typically	< ± 2 dB	< ± 2 dB	< ± 3 dB
Externally Levelled (Excluding coupler and detector variation):			
Crystal Detector or Power Meter	< ± 0.1 dB	< ± 0.1 dB	< ± 0.1 dB
Spurious Signals: (Below fundamental at specified maximum power)			
Harmonically Related:	>20 dB (@ 20 mW) >16 dB (@ 40 mW)	>45 dB >50 dB	>17 dB 5.9-7 GHz >30 dB 7-12.4 GHz
Non-Harmonics:	>60 dB	>60 dB	>60 dB
Source VSWR: 50 nominal impedance			
Internally levelled:	<1.6	<1.6	<1.6
Unlevelled: Typically			<2.5
Modulation Characteristics			
External FM			
Maximum Deviations for Modulation Frequencies			
DC to 100 Hz:	± 75 MHz	± 75 MHz	± 75 MHz
100 Hz to 1 MHz:	± 7 MHz	± 7 MHz	± 7 MHz
1 MHz to 2 MHz:	± 5 MHz	± 5 MHz	± 5 MHz
2 MHz to 10 MHz:	± 1 MHz	± 1 MHz	± 1.5 MHz
Sensitivity: Nominal			
FM Mode:	-20 MHz/V	-20 MHz/V	-20 MHz/V
Phase-lock Mode:	-6 MHz/V	-6 MHz/V	-6 MHz/V
External AM			
Input Impedance: nominal	10 k Ω	10 k Ω	10 k Ω
Frequency Response: Typical	100 kHz	100 kHz	100 kHz
Range: Typical	15 dB	15 dB	15 dB
Pulse Modulation			
Rise/Fall Time: Typical	20 nsec	20 nsec	15 nsec
Minimum Pulse Width			
Levelled: Typical	1 μ sec	1 μ sec	1 μ sec
Unlevelled: Typical	100 nsec	100 nsec	100 nsec
Square Wave Response			
ON/Off Ratio: Typical	>30 dB	>30 dB	>40 dB
Symmetry: Typical	40/60	40/60	40/60
Internal AM:			
Selectable to 1 kHz or 27.8 kHz square wave (Guarantees HP 8755 Frequency Response Test Set compatibility)			
On/Off Ratio:	>30 dB	>30 dB	>40 dB

Ordering Information

83540A 2-8.4 GHz Plug-in (Internal leveling standard)

83540B 2-8.4 GHz Plug-in (Internal leveling standard)

83545A 5.9-12.4 GHz Plug-in (Internal leveling standard)

Options

002: 70 dB Step Attenuator

004: Rear Panel RF Output Connector

SWEEP OSCILLATORS

8350 Series: RF Plug-Ins (cont.)

Models 83570A, 83572A and 83572B

- 83572B offers 5 mW minimum unlevelled 26.5-40 GHz output
- 83570A offers 10 mW internally leveled 18-26.5 GHz output
- 83570A offers low frequency auxiliary output for easy counting and phase-locking

- Calibrated output power with 0.1 dB resolution
- Power sweep
- Complete HP-IB programmability

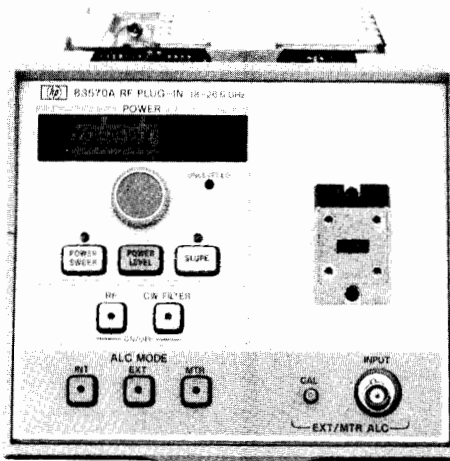

83570A

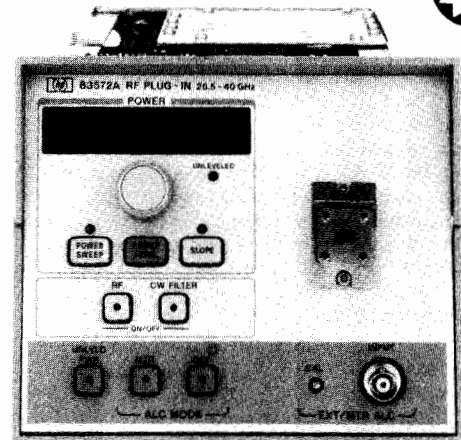

83572A



83570A

Now precision measurements to 26.5 GHz are possible with the solid state 83570 plug-in. The 83570 plug-in maintains a minimum leveled output power of 10 dBm which is comparable to the output power of Backward Wave Oscillators. Power is internally leveled to a flatness $< \pm 1.4$ dB. At the output, power losses are minimized with a waveguide output connector (a coaxial output connector may be made using the HP K281C adapter). Full range coverage of the 83570 extends from 18 GHz to 26.5 GHz. This frequency range maintains a 30 MHz frequency accuracy and 0.1% linearity. With high frequency coverage, complete HP-IB programmability and outstanding leveled output power, the 83570 plug-in, combined with the many features of the 8350 mainframe adds a new dimension to microwave measurements above 18 GHz.

The output power has a calibrated range of 11 dB which can be extended with external attenuators such as the HP 8495K. The power level may be manually set to a 0.1 dB resolution, or the power level may be remotely HP-IB programmed to a 0.02 dB resolution. In addition to a single output power, the 83570 also has a power sweep function. This function sweeps the power from one level to another. Another important feature that the 83570 offers is slope compensation. This compensates for high frequency power losses in external tests by attenuating the power at lower frequencies.

Scalar measurements at high frequencies may be easily made since the 83570 provides internal 27.8 KHz modulation required to interface with the HP 8756A Scalar Network Analyzer. In addition to simplifying the interface circuitry, internal modulation reduces connection losses which are critical at high frequencies.

The high output power and HP-IB programmability also make the 83570A ideal for use with the 8410 Network Analyzer and K8747A Test Set when making vector network measurements from 18 to 26.5 GHz. The +10 dBm output power (unavailable on other solid state sources) is required for proper operation of K8747A mixers.

The 18-26.5 GHz signal is generated by doubling the output of a 9-13.25 GHz YIG oscillator. This half frequency is coupled off to an output which may be used for phase locking or counting. Key to the high power of the HP 83570 is a single doubler package. This package contains the frequency doubler, amplifier, modulator and the leveling coupler with detector. This single package configuration significantly reduces power losses. (See 83570A Block Diagram.)

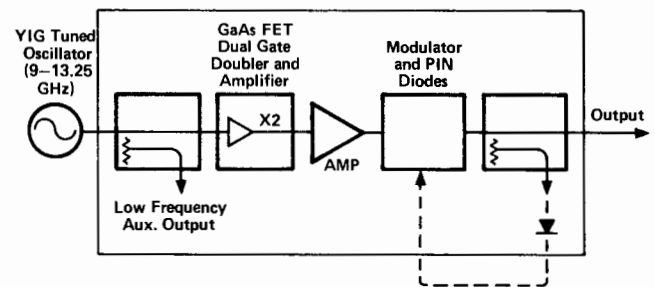

83570A Block Diagram

83572A/B

The HP 83572A/B RF Plug-in extends the frequency coverage to 40.0 GHz. The plug-ins offer minimum unlevelled output power of 7 dBm (83572B), and 3 dBm (83572A) for maximizing the dynamic range of passive device measurements. Option 001 provides 6 dBm (83572B), and 2 dBm (83572A) minimum calibrated externally leveled output power for regulated power control during swept and CW operations. At the output, power losses are minimized with a waveguide output connector. Full range coverage of the 83572 extends from 26.5 GHz to 40.0 GHz. This frequency range maintains a 100 MHz frequency accuracy and 0.2% linearity. With high frequency coverage, complete HP-IB programmability and outstanding leveled output power, the 83572 plug-ins extend the 8350 mainframe capabilities above 26.5 GHz.

The output power has calibrated range of 7 dB. The power level may be manually set to a 0.1 dB resolution, or the power level may be remotely HP-IB programmed to a 0.01 dB resolution. The 83572 also features Power Sweep which allows real time power response measurements of active devices. Another important feature is slope compensation which compensates for system/cable losses at high frequencies.

Scalar measurements at high frequencies may be easily made since the 83572 provides internal 27.8 kHz modulation (Option 006) required to interface with the HP 8756A Scalar Network Analyzer. In addition to amplifying the interface circuitry, internal modulation reduces connection losses which are critical at high frequencies.

The high output power and HP-IB programmability also make the 83572 ideal for use with the 8410 Network Analyzer and R8747B Test Unit when making vector network measurements from 26.5 to 40.0 GHz.



Output Characteristics

RF Power Leveling

Unleveled: selected by front panel switch; refer to chart for figures. Standard for 83572A/B.

Internal: selected by front panel switch; refer to chart for figures. Standard for 83570A.

External

Crystal detector: approximately -20 to -250 mW for specified leveling at rated output; for use with negative polarity detectors such as 422 Series Crystal detectors.

Calibrated crystal detector (option 001): approximately -20 to -250 mW for specified leveling at rated output; for use with negative polarity detectors such as 422 Series Crystal detectors. SHIFT DET switch selects internal calibration for an external coupler, a crystal detector, and a BNC cable, all included in Option 001 of 83572.

Power meter input: switch selects proper compensation for HP 432A/B/C Power Meters.

Indicator: front panel indicator lights when RF power becomes unleveled. Residual AM in 100 kHz Bandwidth: > 50 dBc.

Impedance: 50 Ω nominal

Power Sweep

Calibrated range

83570A: ≥ 11 dB.

83572A/B (option 001 only): ≥ 7 dB, typical.

Accuracy: ± 1.5 dB typical.

Resolution: 0.1 dB

Slope compensation

Calibrated range

83570A: up to 5 dB/GHz (10 dB max, typically 11 dB).

83572A/B (option 001 only): Up to 5 dB/GHz (7 dB max).

Linearity: < 0.2 dB.

Resolution: 0.1 dB/GHz

General Specifications

Sweep Time (minimum over full band)

83570A (18–26.5 GHz): 10 ms

83572A/B (26.5–40.0 GHz): 10 ms.

RF Output Connector

83570A type WR42 waveguide.

83572A/B type WR28 waveguide.

Auxiliary output: (83570A) real panel 9–13.25 GHz fundamental oscillator output, nominally 0 dBm.

Weight: net 5.4 kg (12 lbs). Shipping 8.7 kg (19 lbs).

Improved Network Measurement Capabilities

The 83570A is Compatible with the

8756A Scalar Network Analyzer

5344S Source Synchronizer

8410 Network Analyzer using the K8747A Test Set

The 83572A/B are Compatible with the

8756A Scalar Network Analyzer

8410 Network Analyzer using the R8747B Test Set

Ordering Information

83570A 18–26.5 GHz RF Plug-in (Internal leveling standard)

83572A 26.5–40.0 GHz RF Plug-in

Opt 001: Calibrated External Leveling

Opt 006: Internal Pulse and Square Wave Modulation capability

83572B 26.5–40.0 GHz RF Plug-in

Opt 001: Calibrated External Leveling

Opt 006: Internal Pulse and Square Wave Modulation capability

Frequency Characteristics

	83570A	83572A/B
Range	18–26.5 GHz	
Accuracy (25°C \pm 5°C)		
CW Mode:	± 30 MHz	± 100 MHz
Typical:	± 20 MHz	± 20 MHz
All Sweep Modes:	± 55 MHz	± 150 MHz
Linearity typically:	± 15 MHz	± 50 MHz
Stability		
With Temperature:	800 kHz/°C	± 8 MHz/°C
With 10% Line Voltage Change:	± 80 kHz	± 1 MHz
With 10 dB Power Level Change:	+1 MHz	± 200 kHz
With 3:1 Load SWR:	± 500 kHz	± 100 kHz
With Time: (in 10 minute time period after one hour warmup at the same frequency setting, typical)	± 400 kHz	± 4 MHz
Residual FM: (in 10 Hz–10 kHz bandwidth, CW mode):	<30 kHz	<60 kHz

Output Characteristics

Maximum Leveled Power (25°C \pm 5°C):		>10 mW
Minimum Unleveled Power (25°C \pm 5°C):		>2 mW (5 mW)*
Opt. 001 (at output of external leveling coupler):		1.0 dB less
Opt. 006 (at waveguide output of plug-in):		1.5 dB less
Power Level Accuracy: Typical		
Internally leveled:	± 1.8 dB	
Externally Leveled (Opt. 001):		± 1.5 dB
Resolution (displayed):	0.1 dB	0.1 dB
Remote Programming (settable)	± 0.01 dB	± 0.01 dB
Power Variation (At max. rated power)		
Internally Leveled:	< ± 1.4 dB	
Unleveled: Typically	< ± 2 dB	< ± 3 dB
Externally Leveled (Excluding coupler and detector variation):		
Crystal Detector or Power Meter	< ± 0.1 dB	< ± 0.2 dB
Spurious Signals: (Below fundamental at specified maximum power)		
Harmonically Related:	>25 dB	>50 dB
Non-Harmonics:	>50 dB	>50 dB
Source VSWR: 50 nominal impedance		
Internally leveled:	<2.5	
Externally leveled (Opt. 001)		<1.5
Modulation Characteristics		
External FM		
Maximum Deviations for Modulation Frequencies		
DC to 100 Hz:	± 75 MHz	± 150 MHz
100 Hz to 200 kHz:		± 3.5 MHz
100 Hz to 1 MHz:	± 7 MHz	
1 MHz to 2 MHz:	± 5 MHz	
2 MHz to 10 MHz:	± 1.5 MHz	
Sensitivity: Nominal		
FM Mode:	-20 MHz/V	-20 MHz/V
Phase-lock Mode:	-6 MHz/V	-6 MHz/V
External AM		
Input Impedance: nominal	10 k Ω	30 k Ω
Frequency Response: Typical	100 kHz	10 kHz
Range: Typical		
Internally leveled:	11 dB	
Externally leveled (Opt. 001):		7 dB
Unleveled		30 dB
Square Wave Response		
ON/OFF Ratio: Typical	>30 dB	>20 dB
Symmetry: Typical	40/60	45/55
Internal AM		
Selectable to 1 kHz or 27.8 kHz square wave (Guarantees HP 8756A Scalar Network Analyzer compatibility)		
On/OFF Ratio:	>25 dB	
On/OFF Ratio (Opt. 006):		>20 dB

*83572B only

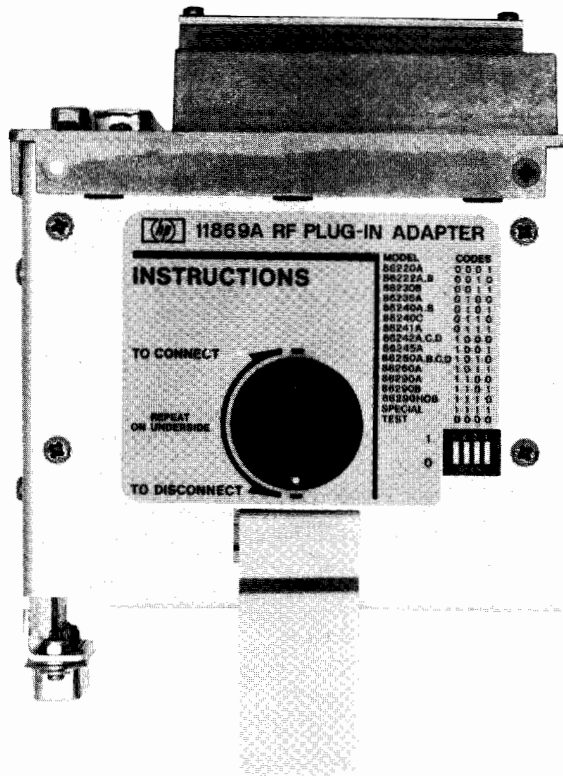

11869A Adapter

The 11869A Adapter provides the electrical and mechanical interface between the 8350 and 86200 series plug-ins. All of the 8350's standard operating features, including HP-IB remote programming, are available. However, specific plug-in functions (output power level, RF on/off, etc.) cannot be controlled or remotely programmed by the 8350 mainframe.

Plug-Ins with Rear Panel RF Output

Option 004 allows the adapter to be used with 86200 plug-ins that are equipped with rear panel RF output. Supplied with Option 004 are two pre-shaped, semi-rigid coax cables with the appropriate mating connectors so that the RF output can be extended to the rear panel of the adapter.

Rear Panel Description

On the rear panel of the 11869A are five hole plugs that can be removed to allow connections to be made to the rear panel. Four of the holes are for low frequency (small diameter) cables while one is for a high frequency (large diameter) RF cable. For user convenience the holes are labeled — AUX OUT, EXT ALC IN, PULSE IN, FREQ REF, and RF OUT.

Three BNC cables are supplied to extend the plug-in rear panel inputs/outputs to the rear panel of the adapter. A separate cable (BNC/SMD) is installed for connection of the plug-in FM input to the adapter/mainframe.

Plug-Ins Compatible with the 11869A Adapter

The 11869A Adapter attaches to the back of the 86200 series plug-in and is equipped with a switch for setting the specific interface code for the plug-in being used.

The following plug-ins will operate in the 8350 by using the 11869A Adapter.

86220A (0.01–1.3 GHz)	86245A (5.9–12.4 GHz)
86222A/B (0.01–2.4 GHz)	86250A/B/C/D (8.0–12.4 GHz)
86230B (1.8–4.2 GHz)	86251A (7.5–18.6 GHz)
86235A (1.7–4.3 GHz)	86260A (12.4–18.0 GHz)
86240A/B (2.0–8.4 GHz)	86260B (10.0–15.5 GHz)
86240C (3.6–8.6 GHz)	86260C (17.0–22.0 GHz)
86241A (3.2–6.5 GHz)	86290A (2.0–18.0 GHz)
86242A/C/D (5.9–9.0 GHz)	86290B/C (2.0–18.6 GHz)
	86290B H08 (2.0–22 GHz)

Special Plug-Ins

For factory modified 86200 series plug-ins with non-standard frequency coverage a special PROM must be inserted in the 11869A Adapter. Consult your local HP Sales and Service Office for further information.

Plug-Ins Not Compatible with the 11869A Adapter

The 8621B RF Drawer and 86300 series RF modules are not compatible with the 11869A and will not operate in the 8350.

Furnished: three BNC cables for extending plug-in rear panel inputs/outputs to adapter rear panel; BNC/SMD (factory installed) for connecting plug-in FM input to adapter/mainframe; plug-in handle assembly for simplified installation in the 8350 mainframe.

Weight: Net, 0.9 kg (2 lb). Shipping, 2.7 kg (6 lb).

Ordering Information

11869A Adapter

Option 004: Extension Cables for Plug-ins with Rear Panel RF Output (Opt. 004)

Special PROM module: For plug-ins with non-standard frequency coverage. (Consult Sales and Service Office)

Option 006: Type N Aux Out Interface Connector for 86251A and 86290A/B/C

SWEEP OSCILLATORS

Solid State Sweeper Series: 10 MHz to 22 GHz

Model 8620 Series



- Single-band, straddle-band and broadband plug-ins
- External phase-lock capability
- > 10 mW to 22 GHz



8620 System

The Hewlett-Packard 8620 solid state sweeper system offers the flexibility of the 8620C mainframe in addition to a choice of single-band, multiband, straddle-band, and broadband plug-ins. The 8620 system also offers high output with solid state reliability—greater than 10 mW leveled to 22 GHz.

The fundamental oscillators used in the plug-ins and modules are YIG tuned transistor or bulk effect circuits. YIG tuning results in exceptional tuning linearity, low noise, and low spurious content; it also allows frequency modulation at high rates and wide deviations with low distortion.

8620C Sweeper Mainframe

The 8620C has many features which are highly useful in stringent applications. With convenient functionally grouped controls and lighted pushbutton indicators the mainframe offers extreme ease of operation and flexibility. In addition, it can be a completely programmable source, either HP-IB or BCD, an indispensable feature for automatic systems and signal simulation applications.

86222A/B and 86290A/B/C Broadband Plug-Ins

Now the 10 MHz to 18.6 GHz frequency range can be covered with just two plug-ins—the 86222A/B and 86290A/B/C. Besides their broad frequency range these plug-ins offer many special features including unique crystal markers in the 86222B and better than ± 30 MHz frequency accuracy in a 86290A/B/C even at 18 GHz.

86240A/B/C and 86251A Straddle-Band Plug-Ins

Covering more than an octave of frequencies the 86240A and B span 2 to 8.4 GHz and the 86251A spans from 7.5 to 18.6 GHz with major advances in power output and signal purity. The 86240A offers more than 40 mW while the 86251A provides over 10 mW of leveled output across the full band. All three plug-ins deliver a high quality test signal of low harmonic content with the 86240B providing harmonics of > 45 dBc. This can be very important when making measurements across more than one octave.

86200 Series Single-Band Plug-Ins

The 86200 series of plug-ins covers both ends of the frequency spectrum from 10 MHz to 22 GHz with a choice of more than eleven plug-ins.

Plug-In Compatibility with 8350

The entire line of 86200 series plug-ins can be used in the 8350 Sweep Oscillator mainframe with no degradation in performance by using the 11869A Adapter.

TYPICAL UNLEVELED POWER OUTPUT

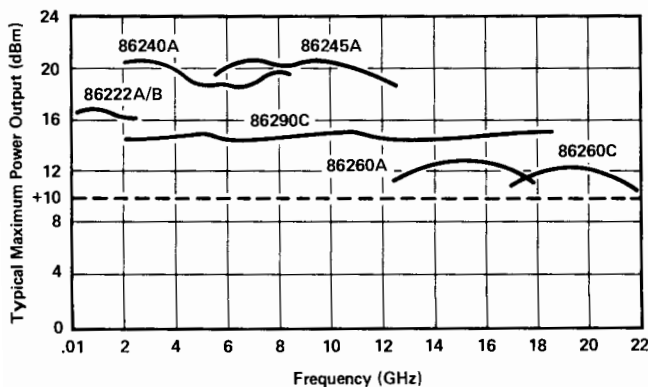



SWEEP OSCILLATORS

8620 Series: Mainframe

Model 8620C

- Optional BCD or HP-IB programming
- 3 markers
- 100% ΔF capability, fully calibrated

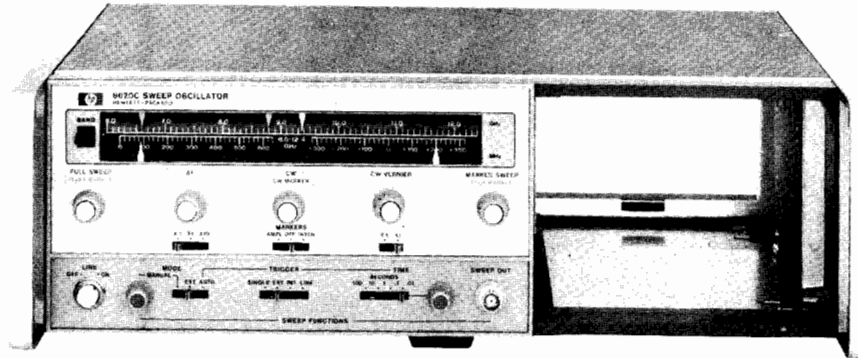

The 8620C offers many features as standard equipment. For example, up to four separate bands and their respective frequency scales can be selected with a band select lever to the left of the dial scale. Pushbuttons, concentrically located in the frequency control knobs, light when actuated to indicate the sweep function in use. The sweep functions available are: FULL SWEEP, MARKER SWEEP, CW/ ΔF and CW. Three markers are available, controlled by the START MARKER, STOP MARKER, and CW MARKER knobs.

The 8620C is fully and continuously calibrated for any ΔF sweep width. The sweep is symmetrical about the CW MARKER setting and three continuously variable ΔF ranges are available by using the range switch below the ΔF knob. This allows calibrated sweep widths of up to 1%, 10% or 100% of full band.

When in CW/ ΔF or CW modes, the CW VERNIER knob allows for excellent frequency resolution. In terms of improved frequency resolution the vernier increases the effective length of the dial scale to 7.5 meters (300 inches).

Another feature is the capability to fully program the sweeper. The standard 8620C includes inputs for band selection, sweep function selection, and analog frequency control. In addition to this, more flexible digital frequency programming options are available to control the 8620C via the HP-IB (Option 011) or by BCD programming (Option 001).

8620C Specifications

Frequency

Frequency range accuracy and linearity: determined by band select lever and RF plug-in installed.

Sweep Functions

FULL SWEEP: sweeps the full band as determined by the plug-in and the band select lever.

MARKER SWEEP: sweeps from START MARKER to STOP MARKER frequency settings; up to the full range of the plug-in can be set to sweep either up or down in frequency.

ΔF Sweep: sweeps symmetrically upward in frequency, centered on CW setting, CW vernier can be activated for fine control of center frequency.

Width: continuously adjustable and calibrated from zero to 1%, zero to 10%, or zero to 100% of frequency band.

CW operations: single-frequency RF output controlled by CW MARKER knob selected by depressing pushbutton in CW MARKER control.

CW vernier: calibrated directly in MHz about CW setting. CW vernier activated by pushbutton in CW vernier control. Zero to $\pm 0.5\%$ or zero to $\pm 5\%$ of full bandwidth, selectable with front panel switch.

Frequency markers: three constant width frequency markers are fully calibrated and independently adjustable over the entire range in FULL SWEEP function, controlled by START MARKER, STOP MARKER, and CW MARKER controls. In ΔF sweep START and STOP MARKERS are available, and in MARKER SWEEP the CW MARKER is available. Front panel switch provides for the selection of either amplitude or intensity markers (amplitude modulating the RF output or Z-axis modulating the CRT display).

Marker output: rectangular pulse, typically -5 volts peak available from Z-axis BNC connector on rear panel. Source impedance, approximately 1000 ohms.

Sweep Modes (auto, manual or externally triggered)

Sweep time: continuously adjustable from 0.01 to 100 seconds. Single sweep, internal sweep, line sweep and external sweep control also available.

Sweep output: direct-coupled sawtooth, zero to approximately $+10$ volts, at front panel BNC connector, concurrent with swept RF output.

Modulation

External AM, FM and phase-lock capability; internal 1000 Hz square wave AM modulation available.

Remote Control

Remote band select: frequency range can be controlled remotely by three binary contact closure lines available at rear panel connector.

Remote Frequency Programming, Opt 001 (BCD) and Opt 011 (HP-IB)

Functions

Band: manual enable or remote control of up to four bands.

Mode: seven modes are selectable, including digital control in three modes with a resolution of 10,000 points.

General

Blanking

RF: with blanking switch enabled, RF automatically turns off during retrace, and remains off until start of next sweep.

Display (Z-AXIS/MKR/PEN LIFT output): direct-coupled rectangular pulse approximately $+5.0$ volts coincident in time with RF blanking is on rear panel.

Negative (negative blanking output): direct-coupled rectangular pulse approximately -5.0 volts coincident in time with RF blanking.

Pen lift: for use with X-Y recorders having positive power supplies. Transistor-switch signal is available on Z-AXIS/MKR/PEN LIFT connector. This signal is also available on the programming connector.

Furnished: 2.29 m (7½-foot) power cable with NEMA plug and calibration scale. With Option 011, an HP-IB connector/adaptor are included.

Power: 100, 120, 220, or 240 volts $+5 - 10\%$, 50 to 400 Hz. Approximately 140 watts.

Weight: (not including RF unit): Net, 11.1 kg (24 lb). Shipping 13.4 kg (30 lb).

Size: 132.6 mm H x 425 mm W x 337 mm D (5.29" x 16.75" x 13.25").

Ordering Information

8620C Sweep Oscillator Mainframe

Opt 001: BCD Frequency Programming

Opt 820: 8410C Interface Cable

Opt 011: HP-IB Frequency Programming

Opt 007: Rear Sweep Out

Opt 908: Rack Flange Kit

SWEEP OSCILLATORS

8620 Series: Broadband RF Plug-Ins

Models 86290A, 86290B and 86290C

387



- +13 dBm 2 to 18.6 GHz with 86290C
- ± 30 MHz frequency accuracy at 18.6 GHz

- Compatible with 8350 mainframe via 11869A adapter

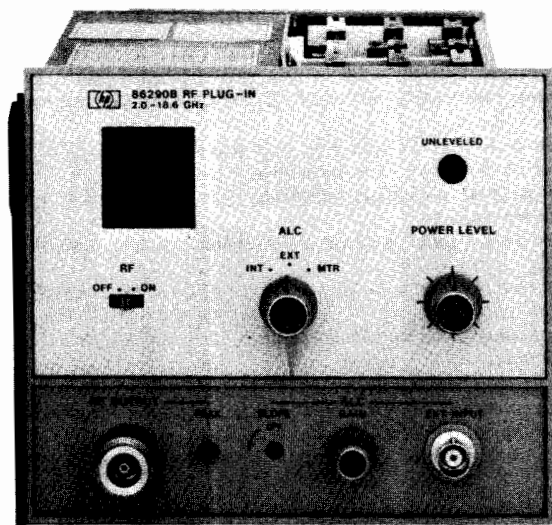

86290B

The 86290A/B/C broadband plug-ins set new standards in sweeper performance and versatility. For broadband testing, a continuous sweep from 2 to 18.6 GHz (18 GHz with the 86290A) is provided. In addition, higher frequency resolution is achieved by covering the 2 to 18.6 GHz range in three individual bands of 2 to 6.2, 6 to 12.4, 12 to 18.6 (or 18 GHz). The 86290C offers outstanding electrical performance producing >20 mW swept output over the 2 to 18.6 GHz range along with excellent linearity and low spurious and harmonic content. For scalar measurements the 27.8 kHz square wave modulation from the HP 8756 Scalar Network Analyzer is accepted directly through the EXTERNAL AM input. When performing phase/amplitude network analysis the interfacing between the sweeper and the HP 8410B/C Network Analyzer permits the 8410B/C to automatically phase lock over multi-octave sweeps for continuous swept 2 to 18.6 GHz phase and amplitude measurements.

Specifications

with Plug-In Installed in an 8620C Mainframe

Frequency Characteristics

	Band 1	Band 2	Band 3	Band 4
Range: (GHz) 86290A	2-6.2	6-12.4	12-18	2-18
86290B/C	2-6.2	6-12.4	12-18.6	2-18.6
Accuracy (25°C)				
CW mode (or >100 ms sweep time): (MHz)	± 20	± 30	± 30	± 100
Remote programming: (typ.)	± 2.5	± 2.5	± 3.5	—
All sweep modes: (MHz)	± 30	± 40	± 40	± 80
Marker: (MHz)	± 30	± 30	± 30	± 80
Linearity (MHz) typ.:	± 8	± 8	± 8	± 30
Frequency Stability				
With temperature: (MHz/°C)	± 0.5	± 1.0	± 1.5	± 2.0
With 10% line voltage change: (kHz)	± 100	± 100	± 100	± 100
With 10 dB power level change: (MHz)	± 0.6	± 1.2	± 1.8	± 1.8
With 3:1 load VSWR, all phases: (kHz)	± 100	± 200	± 300	± 300
With time (in 10 minute period after 30 minute warmup): typically (kHz)	± 300	± 600	± 900	± 900
Residual FM (10 kHz bandwidth CW mode): (kHz peak)	<10	<20	<30	<30

Output Characteristics

Maximum Levelled Power (25°C)

86290A: +7 dBm, 2 to 18 GHz. (Opt. 004: +6.5 dBm)

86290B: +10 dBm, 2 to 18.6 GHz. (Opt. 004: +9.5 dBm)

86290C: +13 dBm, 2 to 18.6 GHz. (Opt. 004: +12.5 dBm)

Power level control range: >10 dBm

	Band 1	Band 2	Band 3	Band 4
Power Variation (Max Rated Pwr)				
Internally levelled: (dB)	± 0.7	± 0.7	± 0.8	± 0.9
Externally levelled (excluding coupler and detector variation)				
Crystal detector: -20 to -250 mV for specified leveling at rated output: (dB)	± 0.15	± 0.15	± 0.15	± 0.15
Power meter: internal leveling amplifier with compensation for HP models 432A/B/C provided: (dB)	± 0.15	± 0.15	± 0.15	± 0.15
With temperature, typically (dB/°C)	± 0.1	± 0.1	± 0.1	± 0.1

Residual AM in 100 kHz BW: >55 dBc.

Spurious Signals

Harmonically related signals: >25 dBc.

Non-harmonics: >50 dBc.

Impedance: 50Ω nominal.

SWR: <1.9 internally levelled.

RF output connector: type N female (standard) and APC-7 (Option 005).

Modulation Characteristics

External AM

Input impedance: approximately 1000Ω .

Frequency response: typically 300 kHz levelled.

Square Wave Response

On/Off ratio: >30 dB.

Symmetry: 40/60.

Attenuation for +5V input: >30 dB.

Internal AM (1000 Hz)

Square-wave On/Off ratio: >25 dB.

RF blanking On/Off ratio: >30 dB.

External FM

Maximum Deviations for Modulation Frequencies

DC to 100 Hz: ± 75 MHz.

100 Hz to 2 MHz: ± 5 MHz.

Sensitivity (typically)

FM mode: -20 MHz/V.

Phase-lock mode: -6 MHz/V.

General

Sweep time (min): 10 ms single bands. 60 ms on 2 to 18.6 GHz band.

Auxiliary output: rear panel 2 to 6.2 GHz fundamental oscillator output, nominally -10 dBm.

Slope control: front panel control allowing compensation for frequency dependent test setup losses.

Peak control: front panel control for peaking power over desired frequency range.

Frequency reference output: nom. 1 V/GHz (2–18.6 volts) ± 35 mV rear panel BNC output.

Weight: net, 4.4 kg (9.6 lb). Shipping, 5.9 kg (13 lb).

Ordering Information

86290A 2 to 18 GHz +7 dBm (5mW) plug-in (internal leveling standard)

86290B 2 to 18.6 GHz +10 dBm (10 mW) plug-in (internal leveling standard)

86290C 2 to 18.6 GHz +13 dBm (20 mW) plug-in (internal leveling standard)

Opt 004: rear panel RF output:

Opt 005: APC-7 RF output connector:



SWEEP OSCILLATORS

8620 Series: Broadband RF Plug-Ins (cont.)

Models 86222A and 86222B

- 10 MHz to 2.4 GHz in one, continuous sweep
- Internally leveled flatness ± 0.25 dB over full range

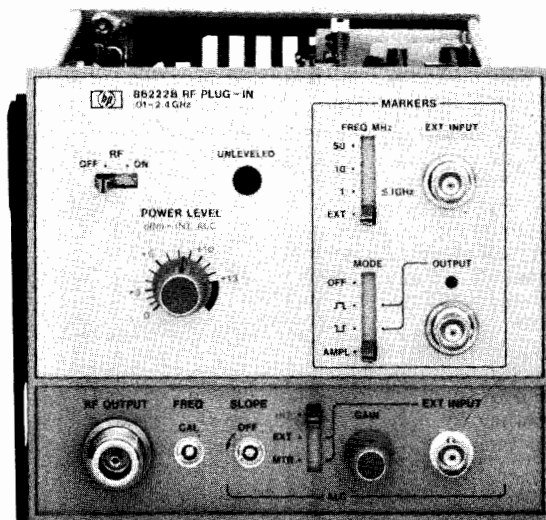

86222B

The 86222A and 86222B RF plug-ins can provide CW or continuous swept 10 MHz to 2.4 GHz frequency coverage. Power output is calibrated from 0 to +13 dBm in 1 dB increments with ± 0.25 dB flatness and excellent linearity (2 MHz) over the entire 0.01 to 2.4 GHz range. For applications demanding precise frequency identification, the 86222B offers a crystal marker system which provides a comb of markers at 1, 10 or 50 MHz. Markers may be displayed as intensified spots on a CRT or as amplitude dips on the RF output (often useful for XY recordings). In addition, when the output frequency is coincident with a 50, 10 or 1 MHz comb of the internal crystal oscillator, a front panel LED lights for independent CW frequency calibration (75 kHz accuracy at 1 GHz). For scalar measurements, the 27.8 kHz square wave modulation from the HP 8756A Scalar Network Analyzer is accepted directly through the external AM input. For phase/magnitude network analysis the interfacing between the sweeper and the 8410B Network Analyzer permits the 8410B to automatically phase-lock over multi-octave sweeps.

Specifications

with Plug-in Installed in an 8620C Mainframe

Frequency Characteristics

Range: 10 MHz to 2.4 GHz.

Accuracy (25°C)

CW mode: ± 10 MHz.

Remote programming: typically ± 1.5 MHz.

All sweep modes: ± 15 MHz (>100 msec sweep time). Accuracy of 86222B may be enhanced to better than ± 200 kHz through use of crystal markers.

Linearity: typically ± 2 MHz.

Stability

With temperature: ± 500 kHz/°C.

With 10% line voltage change: ± 20 kHz.

With 10 dB power level change: ± 100 kHz.

With 3:1 load SWR, all phases: ± 10 kHz.

With time (after 1-hour warm-up): typically ± 100 kHz/10 min.

Residual FM: (10 kHz bandwidth; FM switch in NORM; CW Mode): <5 kHz peak.

Output Characteristics

Maximum leveled power (25°C): >20 mW (+13 dBm); typically >+15 dBm.

Power level accuracy (internal leveling only): ± 1 dB.

Attenuator Opt 002: add ± 0.2 dB/10 dB step.

Power Variation (at max. rated power)

Internally Leveled

0.01 to 2.4 GHz: ± 0.25 dB.

Stability with temperature: typically ± 0.02 dB/°C.

- 1, 10, and 50 MHz crystal marker combs with 86222B
- Compatible with 8350 mainframe via 11869A adapter

Externally Leveled (excluding coupler and detector variation)

Crystal detector: (-10 to -100 mV at rated output): ± 0.1 dB.

Power meter (with HP 432A/B/C Series power meters): ± 0.1 dB.

Residual AM in 100 kHz BW: >50 dBc.

Spurious Signals (below fundamental)

Harmonics: >25 dB at +13 dBm; typically >30 dB at +10 dBm.

Non-Harmonics

0.01 to 2.3 GHz: >30 dB at +13 dBm; typically >40 dB at +10 dBm.

2.3 to 2.4 GHz: >25 dB at +13 dBm; typically >35 dB at +10 dBm.

Broadband noise in 100 kHz bandwidth: typically <-70 dBm.

Impedance: 50 Ω nominal.

SWR: <1.5 internally leveled.

Slope control: allows variable compensation for frequency dependent losses in test set-up.

RF output connector: type N female.

Modulation Characteristics

External AM

Input impedance: approximately 10 k Ω .

Frequency response: typically 150 kHz.

Square Wave Response

On/Off ratio: >30 dB.

Symmetry: 40/60, for > 10 dBm output power.

Attenuation for +6 V input: >30 dB.

Internal AM

1 kHz square-wave On/Off ratio: >30 dB.

RF blanking On/Off ratio: >30 dB.

External FM

Maximum Deviations for Modulation Frequencies

DC to 100 Hz: ± 75 MHz.

100 Hz to 1 MHz: ± 5 MHz.

1 MHz to 2 MHz: ± 2 MHz.

Sensitivity (typically)

FM mode: -20 MHz/V.

Phase-lock mode: -6 MHz/V.

Crystal Marker Capabilities (86222B only)

Internal crystal markers: harmonic markers of 10 and 50 MHz usable over full 0.01 to 2.4 GHz range and 1 MHz markers usable 0.01 to 1 GHz. Positive (+) or negative (-) voltage output pulses can be selected to Z-axis intensify a scope trace; or RF amplitude pips can be selected (at maximum sweep speed pulse width optimized for approximately 10 markers/sweep).

Accuracy of center frequencies (25°C): $\pm 5 \times 10^{-6}$.

Typical Marker Width Around Center Frequency

1 MHz markers: ± 75 kHz.

10 MHz markers: ± 200 kHz.

50 MHz markers: ± 300 kHz.

Temperature stability: typically $\pm 2 \times 10^{-6}$ /°C.

Marker output mode: nominally >3 V.

mode: nominally -3 to -8 V, internally adjustable.

Amplitude mode: typically 0.5 dB, internally adjustable.

General

Weight: net, 2.5 kg (5.5 lb). Shipping 4 kg (9 lb).

Ordering Information

86222A 0.01-2.4 GHz RF Plug-In (internal leveling standard)

86222B 0.01-2.4 GHz RF Plug-In with Crystal and External Markers (internal leveling standard)

Opt 002: 70 dB Step Attenuator (10 dB steps)

Opt 004: Rear Panel RF Output

SWEEP OSCILLATORS

8620 Series: Straddle Band RF Plug-Ins

Models 86240A, 86240B, 86240C and 86251A



- 7.5–18.6 continuous sweep with 86251A
- 45 dBc harmonics with 86240B
- Up to 40 mW output power with 86240A

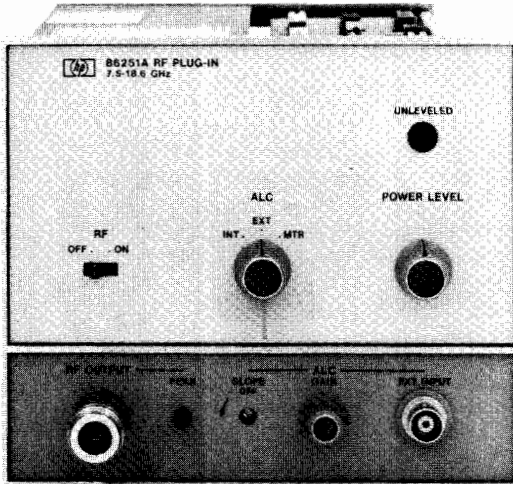

86251A

86251A: 7.5–18.6 GHz

The 86251A excels in meeting the most stringent of swept or CW source requirements for precise Radar and ECM component measurements. Covering the essential frequency bands with one continuous sweep, the 86251A is ideal for testing active devices like multioctave TWT's or RF memories as well as passive devices like filters or isolators.

86240A/B: 2–8.4 GHz

The 86240A/B are designed for high power and superior performance with the 86240A delivering 40 mW of RF output power and the 86240B offering 45 dBc harmonics (typically > 50 dBc). For precise RF power level control, internal leveling (Option 001) and slope control are also available.

86240C RF Distortion Analysis of mW Links: 3.6–8.6 GHz

The 86240C can be used for MLA Upconverter Simulation as well as a general purpose sweeper. It is optimized for group delay of less

- MLA compatibility with 86240C
- Usable in 8350 mainframe with 11869A plug-in adapter

than 1 ns peak-to-peak over 30 MHz, linearity better than 0.5% and power output up to 40 mW. It has 10 MHz FM bandwidth, flat to ± 1.5 dB for noise loading applications, power control and optional leveling. For further information on MLA Upconverter Simulation refer to the Telecommunications Test Equipment section on page 565.

Specifications

with Plug-In Installed in an 8620C Mainframe (or 8350 mainframe using the 11869A plug-in adapter)

Frequency Characteristics

Linearity: typically $\pm 0.1\%$.

Residual FM (in 10 kHz bandwidth, FM switch in NORM, CW Mode): <9 kHz peak. <30 kHz peak for 86251A.

Reference output: dc-coupled voltage proportional to RF frequency, voltage approximately 1 V/GHz.

Output Characteristics

RF Power Leveling

Internal, Option 001: selected by front panel switch; refer to RF plug-in specifications. (Standard on 86240B and 86251A)

Source SWR: 50 Ω nominal impedance

Internally leveled: <1.6 SWR for 86240. <1.9 SWR for 86251A.

Unleveled: typically 3 SWR.

RF output connector: type N female.

86240C Modulation Characteristics

External FM (maximum deviation for modulation frequencies)

DC to 100 Hz: ± 100 MHz

90 kHz to 10 MHz: ± 1.5 MHz

Frequencies response, dc to 10 MHz: ± 1.5 dB

Nominal Sensitivity

FM mode: +20 MHz/volt

Upconverter mode: +20 MHz/volt

General

Weight: Net, 2.3 kg (5 lb). Shipping, 3.2 kg (7 lb) for 86240A/B/C. Net, 4.4 kg (9.6 lb). Shipping, 5.9 kg (13 lb) for 86251A.

Options

002: 70 dB Step Attenuator (86240A/B/C only)

004: Rear Panel RF Output

005: APC-7 RF Output Connector (86251A only)

	86240A	86240B	86240C	86251A
FREQUENCY				
Frequency Range (GHz):	2.0–8.4	2.0–8.4	3.6–8.6	7.5–18.6
Frequency Accuracy: (25°C)				
CW Mode (MHz)	± 25	± 25	± 25	± 30
CW Remote Programming typically (MHz):	± 3.5	± 3.5	± 3.5	± 3.5
All Sweep Modes (for sweep time > 100 ms) (MHz):	± 40	± 50	± 35	± 40
POWER OUTPUT				
Maximum Leveled Power (25°C) (mW):	>40	>20	>40	>10
With Option 002 (mW):	>32	>16	>32	
Power Variation: (At Max Rated Power)				
Unleveled (Typically) (dB):	< ± 6	< ± 6	< ± 6	< ± 5
Internally Leveled (Opt 001):	< ± 1	< ± 0.5	< ± 0.8	± 0.8
Externally Leveled (Excluding Coupler and Detector Variation) Crystal Detector and Power Meter (dB):	< ± 0.1	< ± 0.1	< ± 0.1	± 0.15
Spurious Signals: (dB below fundamental at specified maximum power)				
Harmonics:	>20 (@20 mW) >16 (@40 mW)	>45	>20 (@20 mW) >16 (@40 mW)	>40
Nonharmonics:	>60	>60	>60	>30
Plug-in:				
Opt 001 (Internal Leveling):				

SWEEP OSCILLATORS

8620 Series: Single Band RF Plug-Ins

Model 86200 Series and 11869A Adapter

- 10 MHz to 22 GHz coverage
- >50 mW from 5.9 to 12.4 GHz
- Compatible with 8350 mainframe via 11869A adapter

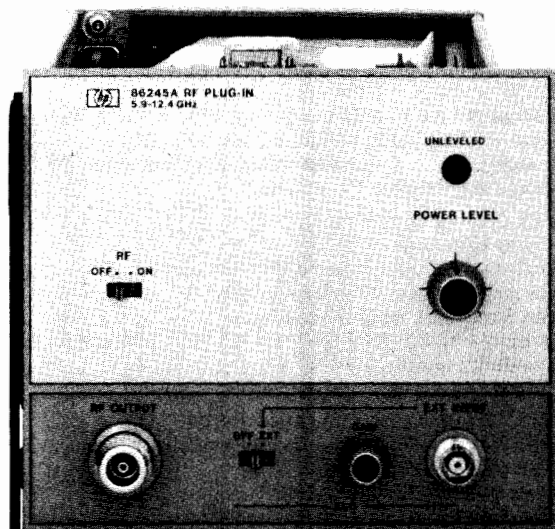

86245A

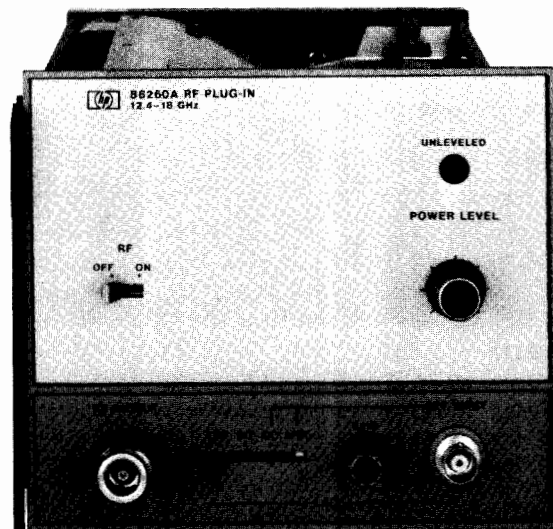

86260A

86200 Series

The 86200 series plug-ins feature a wide choice of bandwidths and power specifications for covering the 10 MHz to 22 GHz frequency range. The 86222A/B 10 MHz to 2.4 GHz plug-ins, the 86240A/B/C 2 GHz to 8.6 GHz plug-ins, and the 86290A/B/C 2 GHz to 18.6 GHz plug-ins cover multi-octave frequency ranges with exceptional frequency precision and RF output characteristics. See preceding pages for specifications on these plug-ins. For octave band applications, smaller range plug-ins covering, for instance, 5.9 GHz to 12.4 GHz are available with optional capability to operate as up-converters for MLA measurements.

11869A Adapter

The 86200 series can be used in the 8350 Sweep Oscillator mainframe with the addition of the 11869A Adapter. The 11869A provides the electrical and mechanical interface between the 86200 plug-in and the 8350 so that digital control of the plug-in is possible. All of the performance and features of the 8350 Sweep Oscillator Mainframe are available when using the 86200 plug-ins and 11869A Adapter. For more information on the 11869A see page 384.

Specifications

With Plug-In Installed In an 8620C Mainframe

Frequency linearity: typically $\pm 1\%$.

Frequency reference output: typically 1 V/GHz dc-coupled voltage is available for referencing or phase-locking external equipment to the plug-in or for multi-octave operation with an 8410B/C.

RF power leveling: internal dc-coupled leveling amplifier and PIN modulator provided.

Internal, Opt 001: selected by front panel switch; refer to RF plug-in specifications (standard on 86220A).

External

Crystal input: approximately -20 to 250 mV for specified leveling at rated output; for use with negative polarity detectors such as 780

Series Directional Detectors, 423A/B and 8470 Series Crystal Detectors.

Power meter input: leveling amplifier with compensation for HP 432A power meter included internally in all plug-ins except the 86230B and 86241A which require the use of an 8404A Leveling Amplifier and the EXT AM input on the 8620 Mainframe.

Indicator: front panel indicator lights when RF power level is set too high to permit leveling over entire selected sweep range or when operating in unlevelled mode.

Residual AM in 100 kHz bandwidth: >50 dB below fundamental at specified maximum power.

External AM

Frequency response: typically dc to 100 kHz unlevelled, dc to 50 kHz levelled (at maximum levelled power).

Input impedance: approximately 5000 ohms.

RF output connector: type N Female.

8350 Compatibility: the 11869A Adapter provides the electrical and mechanical interface so that the 86200 series plug-ins can be used in the 8350 Sweep Oscillator mainframe. For more information see the section on 11869A Adapter page 384.

Weight: net, 2.3 kg (5 lb). Shipping, 3.2 kg (7 lb).

Options

001: Internal leveling. Refer to RF plug-in specifications.

002: 70 dB attenuator in 10 dB steps

004: rear panel RF output

005: APC-7 RF output connector available on 86260A

Upconverter simulation options: options are available which guarantee compatibility with the HP Microwave Link Analyzer. For further information on these plug-ins refer to the Telecommunications Test Equipment Section beginning on page 565.

Single Band Plug-Ins

Refer also to Broadband Models 86222A/B (0.01-2.4 GHz), 86240A/B/C (2-8.6 GHz), 86251A (7.5-18.6 GHz), and 86290A/B/C (2-18.6 GHz)

Specifications with plug-in installed in 8620C	86220A	86230B	86235A	86241A	86242D	86245A	86250D	86260B	86260A	86260C
Frequency range¹ (GHz):	0.01-1.3	1.8-4.2	1.7-4.3	3.2-6.5	5.9-9.0	5.9-12.4	8.0-12.4	10.0-15.5	12.4-18.0	17.0-22.0
Frequency accuracy CW mode (MHz):	±10	±15	±20	±30	±35	±40	±40	±50	±50	±50
Remote programming typically (MHz):	±6.0	±2.5	±2.5	±10.5	±5.0	±20	±20	±5.5	±5.5	±6.8
All sweep modes (sweep time >100 ms) (MHz):	±15	±20	±30	±33	±40	±50	±50	±70	±70	±70
Stability: With Temperature:	±600 kHz/°C	±500 kHz/°C	±500 kHz/°C	±650 kHz/°C	±750 kHz/°C	±1.2 MHz/°C	1.2 MHz/°C	±5.4 MHz/°C	±5.4 MHz/°C	±5.4 MHz/°C
With 10% Line Voltage Change:	±20 kHz	±20 kHz	±40 kHz	±30 kHz	±40 kHz	±40 kHz	±40 kHz	±180 kHz	±180 kHz	±180 kHz
With 10 dB Power Level Change:	±20 kHz	±1 MHz	±1 MHz	±1 MHz	±1.5 MHz	±1.5 MHz	±1.5 MHz	±6 MHz	±6 MHz	±6 MHz
With 3:1 Load SWR Change, all Phases:			±250 kHz		±250 kHz	±250 kHz	±250 kHz			
With Time (after warm-up): Typ/10 min.	±200 kHz	±200 kHz	±200 kHz	±200 kHz	±600 kHz	±600 kHz	±600 kHz		±450 kHz	
Residual FM (10 kHz BW, FM switch in NORM) CW mode (kHz peak):	<5	<7	<7	<7	<15	<15	<15	<25	<25	<25
Maximum leveled power¹ (mW):	10	>10	>40	>7	>10	>50	>10	>10	>10	>10
Power variation Internally leveled (dB):	<±0.5	<±1.2	<±0.8	<±0.8	<±0.5	<±0.6	<±0.5	<±0.7	<±0.7	<±0.7
Externally leveled (dB) (excluding coupler & detector variation):	N/A	<±0.1	<±0.1	<±0.1	<±0.1	<±0.1	<±0.1	<±0.1	<±0.1	<±0.1
Spurious signals: (dB below fundamental, at specified max power) Harmonics:	>25	>20	>20	>16(3.2-3.8 GHz) >20(3.8-6.5 GHz)	>30	>17(5.9-7 GHz) >30(7-12.4 GHz)	>30	>25	>25	>25
Nonharmonics:	>50	>60	>60	>60	>60	>60	>60	>60	>50	>50
Source SWR: (50 Ω nom, Internally leveled)	<1.3	<1.6	<1.6	<1.6	<1.6	<1.6	<1.6	<1.6	<1.6	
External FM: Max deviations (MHz) for modulation frequencies: DC-100 Hz:	±15	±25	±75	±25	±100	±100	±100	±75 (DC-200 kHz)	±75 (DC-200 kHz)	±75 (DC-200 kHz)
DC-1 MHz:	±0.5	±2	±5	±2	±7	±7	±7	±5(200 Hz-200 kHz)	±5(200 Hz-200 kHz)	±5(200 Hz-200 kHz)
Sensitivity (nom, MHz/V):	+3.5	-4	-20/-6	-6	-20/-6	-20/-6	-20/-6	-20/-6	-20/-6	-20/-6
AM: Internal 1 kHz Square wave On/Off ratio & EXT AM sensitivity To -10 V (dB):	>35	>25	>30	>25	>40	>40	>40	>25	>25	>25
EXT AM Response compatible with 8755 Mod drive signal:	No	No	Yes	No	Yes	Yes	Yes	No	No	No

¹ Special frequency band and high power outputs available on request.



Microwave measuring techniques

Hewlett-Packard offers a complete line of microwave coaxial and waveguide measuring equipment. Measuring systems can be assembled from this equipment to make accurate reflection and transmission measurements on other components such as filters, mixers, cables, etc. Signal characteristics such as frequency, power, or spectral content may be measured using other associated equipment.

HP equipment capability ranges from inexpensive systems for point-by-point, narrow-band work to powerful analyzers which furnish dynamic displays of error-corrected network scattering parameters across wide frequency bands. Equipment selection and measuring techniques depend primarily on the accuracy, speed, and cost requirements of the application.

Some applications require complete phase and amplitude characterization of microwave components. These vector measurements are usually made in design labs to aid in component design or in evaluating performance to phase specifications. Such phase measurements require relatively sophisticated equipment and techniques.

But the majority of microwave measurements made in production, test, maintenance, and calibration require only amplitude (scalar) characteristics. Scalar test procedures are popular because they are straightforward, easy-to-use, and low cost, yet yield an excellent measure of the quality of the test part.

This technical section is a summary of the most popular day-to-day microwave scalar tests. Comparison tables give approximate dynamic ranges and accuracies for the various techniques.

More detailed information is available in the following publications:

AN 64-2 Extended Applications of Automatic Power Meters
AN 183 High Frequency Swept Measurements
Coaxial & Waveguide Measurement Accessories Catalog &
Microwave Measurement Handbook.



Table 1. HP Impedance/SWR Measuring Techniques and Capabilities

Measurements Technique	Coaxial Freq. Range	Waveguide Freq. Range	Typical Range	Remarks/Cost/Accuracy/Speed
Manual Slotted Line	1-18 GHz	8.2-18 GHz (2 Bands)	30-35 dB	Lowest cost, high accuracy, slow, point-by-point
Reflectometer Square-Law	100-4000 MHz 2-18 GHz	8.2-40 GHz (4 Bands)	35-40 dB	Moderate cost, moderate accuracy, fast, comprehensive
Reflectometer RF-Substitution	100-4000 MHz 2-18 GHz	8.2-40 GHz (4 Bands)	50 dB	Moderate cost, high accuracy, fast, requires display storage
Bridge	1-110 MHz 40 MHz-26 GHz	—	40 dB	Multi-octave, good for coax, best for low SWR, 9 dB insertion loss

Table 2. HP Insertion Loss Measuring Techniques and Capabilities

Measurement Technique	Coaxial Freq. Range	Waveguide Freq. Range	Typical Range	Remarks/Cost/Accuracy/Speed
Square-Law	10 MHz-26 GHz	8.2-40 GHz (4 Bands)	50 dB	Low cost, moderate accuracy, simple, fast
RF Substitution	10 MHz-26 GHz	8.2-18 GHz 18-40 GHz	50-100 dB 50-80 dB	Moderate cost, high accuracy fast, requires display storage
IF Substitution	10 MHz-26 GHz	2.6-18 GHz (5 Bands)	30-120 dB	High cost, very high accuracy, best range, moderate speed
Desktop computer mini-system	100 kHz-4 GHz 10 MHz-26 GHz	—	40-70 dB	Moderate cost, very high accuracy, automated

Table 3. Coaxial Reflectometer and Bridge Test—Square-Law and RF-Substitution Methods

	Frequency Range	L.P. Filter	Dual-Directional Coupler (Bridge)	Detectors		Standard RF Substitution Attenuator	Calibrating Loads	Calibrating Shorts	RF Plug-ins for HP 8620C and 8350A Sweepers
				[2 Required]	OR [2 Required]				
COAXIAL	215-450 MHz	—	774D	423B	11664A	8495A	908A		86220A/83522A
	450-940 MHz	360B	775D	423B	11664A	8495A	908A	N (m)	86220A/83522A
	940-1900 MHz	360C	776D	423B	11664A	8495A	908A	11512A	86222A/B/83522A
	1900-4000 MHz	360D	777D	423B	11664A	8495A	908A	N (f)	86235A/83525A/B
	100-2000 MHz	360C	778D	423B	11664A	8495A	908A	11511A	86222A/B/83522A
	2-18 GHz	—	11692D	8470B	11664A	8495B	907A	APC-7	86290B/C/83590A
	18-26.5 GHz	K362A	K752C(2)/K281C	K422A	11664B	K382A	911C	APC-3.5	N/A / 83570A
0.1-110 MHz	—	(8721A)	8471A	—	8495A	908A	11565A	8601A/86220A/B	
0.5-1300 MHz	—	8502A	—	—	—	908A		86220A/83522A	
40 MHz-18 GHz	—	(11666A)	—	Inside 11666A	—	909 Opt. 012		83592A	
		See 11678A L.P. Filters		Using 415E/7015A X-Y Recorder.	Using 8756A Test System.	Delete if using Square-law. Add 8494B for 1-dB steps.	Used to calibrate actual system directivity.		Some sweepers require 11665B modulator when using 8756A

Table 4. Waveguide Reflectometer Tests—Square-Law and RF Substitution Methods

	Frequency Range	L.P. Filter	Coax Adapter ¹	Isolator	Forward Coupler	Reverse Coupler	Detectors [2 Required]	Detectors [2 Required]	Standard RF Substitution Attenuator	Calibrating Loads/Shorts	RF Plug-ins for HP 8620C and 8350A Sweepers
WAVEGUIDE	8.2-12.4 GHz	11686A (Coax) X362A (W/G)	X281A	0960-0068	X752D	X752C	X424A	X281A/11664A	X382A	X914B/X932A	86250D/83545A
	12.4-18.0 GHz	P362A	P281B-Option 13	0960-0080	P752D	P752C	P424A	P281B-Opt. 013/ 11664A	P382A	P914A/P920B	86260A/83590A
	18.0-26.5 GHz	K362A	08696-90104	0960-0081	K752D	K752C	K422A	11664B	K382A	K914B/K920B	83570A
	26.4-40 GHz	R362A	08697-90104	0960-0082	R752D	R752C	R422A	11664C/R422A	R382A	R914B/R920B	83572A
			K & R-Band are H-Plane Bends	Optional Contact HP	Use C-Model (10 dB) if source is <10 mW		Using 415E SWR Meter Plus X-Y Recorder	Using 8756A Display	Delete if using Square-law method		8350A/83595A covers 10 MHz—26.5 GHz in one source.



MICROWAVE TEST EQUIPMENT

Microwave Measurements and Products

Equipment Selection Tables (cont.)

Table 5. Slotted Line Tests

	Frequency Range	L.P. Filters/ Coaxial Adapters	Slotted Line	Detector	Display	Source
COAXIAL	Manual Slotted Line 1.8-18 GHz	(11678A Kit 5 Filters)	816A/809C	447B	415E	Signal Generators/Sweepers
WAVEGUIDE	Manual Slotted Line 8.2-12.4 GHz 12.4-18 GHz	X362A/X281A P362A/P281B-Option 13	X810B/809C P810B/809C	447B 447B	415E 415E	Signal Generators/Sweepers

Table 6. Comparison of Equivalent Output and Input SWR for Various Coaxial Components

Frequency Range	Source Isolation Alternates								Detector Alternates								
	Coaxial Pads				Coaxial Couplers				Power Splitter 11667A Type N	Crystal LBSD 8470B 8473C ¹		HCD with 8755 11664A 11664B ²		Thermocouple Sensor 8481A 8485A ³			
	8491B Type N		8492A/APC-7 8493C/APC-3.5 ⁴		786D (787C)	788C (789C)	779D	11691D		Spec.	Typ.	Spec.	Typ.	Spec.	Typ.	Spec.	Typ.
	Spec.	Typ.	Spec.	Typ.	—	—	—	—	Spec.	Typ.	Spec.	Typ.	Spec.	Typ.	Spec.	Typ.	
COAXIAL	DC (50 MHz) - 1 GHz	1.2	1.1	1.15	1.08	—	—	—	—	1.1	1.05	1.15	1.08	1.25	1.16	1.1	1.02
	1 - 2 GHz	1.2	1.1	1.15	1.08	1.13	—	—	—	1.1	1.05	1.15	1.08	1.25	1.16	1.1	1.02
	2 - 4 GHz	1.2	1.1	1.15	1.08	(1.16)	—	1.2	1.2	1.1	1.05	1.15	1.08	1.25	1.16	1.18	1.05
	4 - 6 GHz	1.2	1.1	1.15	1.08	—	1.25	1.2	1.2	1.1	1.1	1.3	1.15	1.38	1.20	1.18	1.1
	6 - 8 GHz	1.2	1.1	1.15	1.08	—	1.25	1.2	1.2	1.2	1.1	1.3	1.15	1.38	1.25	1.18	1.1
	8-10 GHz	1.3	1.15	1.25	1.1	—	(1.25)	1.2	1.2	1.33	1.2	1.3	1.15	1.92	1.30	1.18	1.1
	10 - 12 GHz	1.3	1.2	1.25	1.15	—	(1.25)	1.2	1.2	1.33	1.2	1.3	1.2	1.92	1.43	1.18	1.1
	12 - 14 GHz	1.5	1.2	1.35	1.15	—	—	—	1.2	1.33	1.2	1.3	1.2	1.92	1.50	1.28	1.15
	14 - 16 GHz	1.5	1.25	1.35	1.2	—	—	—	1.2	1.33	1.2	1.4	1.2	1.92	1.60	1.28	1.15
	16 - 18 GHz	1.5	1.3	1.35	1.2	—	—	—	1.2	1.33	1.2	1.4	1.25	1.92	1.60	1.28	1.2
	18 - 26.5 GHz	—	—	1.25 ⁵	1.2 ⁶	—	—	—	—	—	—	2.2 ¹	1.5 ¹	2.2 ²	2.0 ²	1.25 ³	1.18 ³

Table 7. Coaxial Insertion Loss Tests—Square-Law and RF-Substitution Methods

Frequency Range	Source Isolation Alternates			Detector Alternates			RF-Substitution Attenuator	RF Plug-Ins for HP 8620C and 8350A Sweepers	
	Coaxial Pad	Coaxial Couplers	Power Splitter	LBSD Detectors	Schottky Detectors	Thermocouple Sensor			
COAXIAL	DC [50 MHz] - 1 GHz	8491A	—	11667A	423B	11664A	8482A	8495A	86220A/83522A
	100-2000 MHz	8491A	778D	11667A	423B	11664A	8482A	8495A	86222A/B/83522A
	1-2 GHz	8491A	786D	11667A	423B	11664A	8482A	9495A	86222A/B/83522A
	2-4 GHz	8491A	787D	11667A	423B	11664A	8481A	9495A	86235A/83540A/B
	4-8 GHz	8491A	788C	11667A	423B	11664A	8481A	8495B	86240A/B/83540A/B
	8-12.4 GHz	8491A	789C	11667A	423B	11664A	8481A	8495B	86250D/83545A
	12.4-18 GHz	8491B	—	11667A	8470B	11664A	8481A	8495B	86260A/83590A
	18-26.5 GHz	8493C	K752C/K281C	—	8437C	11664B	8485A	K382A	N/A /83570A
	DC-18 GHz	8491B	—	11667A	—	—	—	8495B	—
	10 MHz-18 GHz	8491B	—	11667A	8470B	11664A	8481A	8495B	N/A /83592A
	50 MHz-26.5 GHz	8493C	—	—	8473C	11664B	8485A	8495D	N/A /83595A
	2-18 GHz	8491B	11691D	11667A	8470B	11664A	8481A	8495B	86290B/C/83590A
	1-12 GHz	8491B	779D	11667A	8470B	11664A	8481A	8495B	86290B/C/83590A

See 11678A L.P. Filter Kit for 2-18 GHz.

Using 415E Meter + X-Y Recorder.

Using 8756A Display.

Using 435A/436A Power Meter.

Delete is using Square-law method.

Some sweepers require 11665B modulator when using 8756A.

Table 8. Waveguide Insertion Loss Tests—Square-Law and RF-Substitution Methods

Frequency Range	L.P. Filter	Coax Adapter ¹	Isolator	Forward Coupler	Isolating Coupler	Detectors [2 req'd]	Detectors [2 Req'd]	RF-Substitution Attenuator	RF Plug-Ins for HP 8620C and 8350A Sweepers	
WAVEGUIDE	8.2-12.4 GHz	11686A/ X362A	X281A	0960-0068	X752D	X752C	X424A	X281A/11664A	X382A	86250D/83545A
	12.4-18.0 GHz	P362A	P281B Opt. 013	0960-0080	P752D	P752C	P424A	P281B - Opt. 013/ 11664A	P382A	86260A/83590A
	18.0-26.5 GHz	K362A	08696-90104	0960-0081	K752D	K752C	K422A	11664B	K382A	N/A /83570A
	26.5-40.0 GHz	R362A	08697-90104	0960-0082	R752D	R752C	R422A	11664C/R422A	R382A	N/A /83572A

¹K & R-Bank are H-Plane Bends.

Optional, Contact HP

Use C-model if source is < 10 mW

Using 415E Meter +X-Y Recorder.

Using 8756A Display, may require 11665B Modulator.

Delete is using Square-law Method.

8350A/83595A covers 10 MHz - 26.5 GHz in one source.

MICROWAVE TEST EQUIPMENT

Microwave Measurements and Products

Waveguide Instrumentation Summary

395



Instrument Name	Uses	Family Model Number	Frequency Coverage by Band—GHz							
			S 2.6– 3.95	G 3.95– 5.85	J 5.30– 8.20	H 7.05– 10.0	X 8.20 12.4	P 12.4– 18.0	K 18.0– 26.5	R 26.5– 40.0
Adapters	Interconnect coaxial-waveguide system. Interconnect two different waveguide systems.	281A	X	X	X	X	X			
		281B					X	X		
		281C					X	X	X	
		292A						X	X	
		292B				X	X	X		
		11515A 11516A								X
Attenuators, Variable	Measure reflection coefficient, insertion loss, transfer characteristics by RF substitution; reduce power levels; improve source mismatch.	382A		X	X	X	X	X	X	X
		382C	X							
		375A					X	X		
Detectors, Crystal	Detect RF power, CW or pulsed; measure reflection coefficient, insertion loss.	422A							X	X
		424A					X	X		
Directional Couplers	Sample high power, level power, measure reflection coefficient, improve mismatch.	752A					X	X	X	X
		752C					X	X	X	X
		752D					X	X	X	X
Filters Low Pass	Reduce harmonics from signal sources.	362A					X	X	X	X
Frequency Meters	Measure frequency.	532A						X	X	X
		532B					X			
Mixers	Mix signals, generate harmonics.	932A						X		
		11517A						X	X	X
Modulators, PIN	Modulate RF signals with AM, pulse modulation with low incidental FM.	8735B					X			
Power Sensors, Thermistor	Measure microwave power; used with HP 432 Meter	486A					X	X	X	X
Shorts Sliding Switched	Establish measurement planes, reflection phase and magnitude references.	920B						X	X	X
		923A					X			
		930A					X			
Slide Screw Tuners	Correct discontinuities in waveguide.	870A					X	X		
Phase Shifters	Provide phase control.	885A					X	X		
Slotted Line Systems	Measure SWR, wavelength, impedance.	810B					X	X		
Terminations Fixed and Sliding	Fixed loads for terminating waveguide systems, sliding loads for separating load reflections from other system reflections.	910A						X		
		910B					X	X		
		914A							X	
		914B					X		X	X



Instrument Name	Uses	Frequency Coverage by Model												
		DC	10 MHz	100 MHz	500 MHz	1 GHz	2 GHz	4 GHz	6 GHz	8 GHz	10 GHz	12.4 GHz	18 GHz	26.5 GHz
Filters High Pass	May be required for measurements on active devices with gain below 50 MHz.					11697A/B/C	11668A							
Frequency Meters	Measure frequency.					536A			537A					
Mixers	Mix frequencies, generate harmonics.		10514A 10534A						934A				11521A	11517A*
Noise Sources	Measure noise figure of microwave components													
PIN Modulators	Modulate RF signals with AM, pulse modulation with low incidental FM.					8731B-H10 8731B		8732B 8733B		8734B				
Power Sensors Thermistor Thermocouple High Sensitivity Broadband Peak Power	Detect microwave power (use with 432, 435, 436 power meters). Use with 8900C/D Peak Power Meter					33000C/D			11720A				33008C/D 33001C/D	
Power Splitters	Establish reference signal for ratio measurements. Split signal for comparison measurement.													
Shorts Fixed	Establish 0 dB, ±180° reference for reflection measurements.													
Slotted lines Manual	Measure SWR, wavelength, impedance.													
Switches (Mechanical)	Electrically switch RF signals.													
Switches (Solid State)	Fast switching applications.													
Terminations Fixed	Fixed loads for terminating RF lines, sliding loads for separating load and system reflections.													
Sliding														

* Covers 12.4 to 40 GHz.

MICROWAVE TEST EQUIPMENT

Adapters, Waveguide Stands, Air Lines

Models 281A/B/C, 292A/B, 11515/6/A, 11540 Series, 11566/7/A, 11588A, 11606A

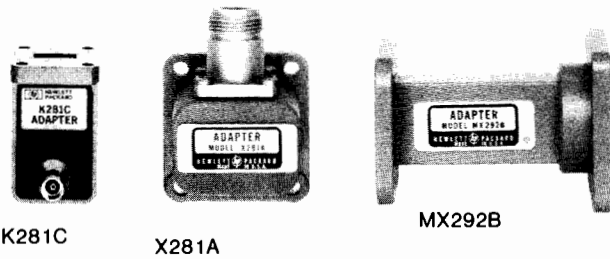

K281C

X281A

MX292B



11566A



11515A



11606A



11588A

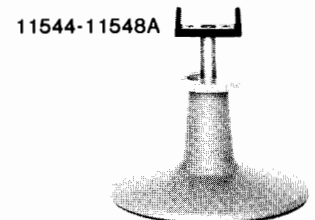

11540A

281A/B/C, 292A/B, 11515A/6A Coax and Waveguide Adapters

HP 281A,B adapters transform waveguide transmission line into 50-ohm coaxial line. The newer 281C family has improved SWR.

Models 292A,B waveguide-to-waveguide adapters connect two different waveguide sizes with overlapping frequency ranges. Models 11515A/16A adapt circular to rectangular flanges in K-band and R-band.

281A/B/C Specifications

HP Model	SWR	Frequency Range (GHz)	Waveguide Size EIA	Coaxial Connector	W/G Flange UG-() U
S281A	1.25	2.60-3.95	WR284	N Female	584
G281A	1.25	3.95-5.85	WR187	N Female	407
J281A	1.25	5.30-8.20	WR137	N Female	441
H281A	1.25	7.05-10.0	WR112	N Female	138
X281A	1.25	8.20-12.4	WR90	N Female	135
X281B	1.25	8.20-12.4	WR90	APC-7	135
Option 013				N Female	
P281B	1.25	12.4-18.0	WR62	APC-7	419
Option 013				N Female	
X281C	1.05	8.20-12.4	WR90	APC-7	135
Option 012				N Male	
Option 013				N Female	
P281C	1.06	12.4-18.0	WR62	APC-7	419
Option 012				N Male	
Option 013				N Female	
K281C	1.07	18.0-26.5	WR42	APC-3.5 (f)	597
Option 012				APC-3.5 (M)	

292A/B, 11515A, 11516A Specifications

HP Model	Frequency Range (GHz)	SWR	W/G Size Flange	to	W/G Size Flange
HX292B	8.2-10.0	1.05	WR 112 UG-51/U		WR 90 UG-39/U
MX292B	10.0-12.4	1.05	WR 75 Cover		WR 90 UG-39/U
MP292B	12.4-15.0	1.05	WR 75 Cover		WR 62 UG-419/U
NP292A	15.0-18.0	1.05	WR 51 Cover		WR 62 UG-419/U
NK292A	18.0-22.0	1.05	WR 51 Cover		WR 42 UG-595/U
11515A	18.0-26.5	—	WR 42 UG-425/U		WR 42 UG-595/U
11516A	26.5-40.0	—	WR 28 UG-381/U		WR 28 UG-599/U

11588A Swivel Adapter, 11606A Rotary Air Line

The 11606A rotary air line and the 11588A swivel adapter are capable of a full 360° of rotation. A combination of the air line and the adapter permits rigid coax movement in three dimensions. Even the most awkwardly shaped devices can be easily connected or disconnected in a coax system with the aid of these components. Insertion loss is <0.5 dB and uncertainty due to rotation is -57 dB.

11566A, 11567A Air Line Extension

Impedance: 50 ohms.

Frequency: dc-18 GHz.

Reflection coefficient: 0.018 + 0.001 (frequency in GHz).

Connector: APC-7

Length: 11566A, 102.5 mm (4 in.); 11567A, 202.5 mm (8 in.).

Shipping weight: 0.45 kg (1 lb).

11540 Series Waveguide Stand, Waveguide Holders

The 11540A waveguide stand locks HP waveguide holders at any height from 70 to 133 mm (2.75 in. to 5.25 in.). The waveguide holders are offered in five sizes to hold waveguide covering frequencies from 7 to 40 GHz.

11588A, 11606A Specifications

HP Model	Frequency Range GHz	SWR	Connectors	Dimensions mm (in)	Shipping Weight kg (lb)
11588A	DC-12.4	1.1	APC-7(m)(f)	42 x 59 x 30 (1 3/4 x 2 1/4 x 1 3/16)	0.28 (10 oz.)
11606A	DC-12.4	1.1	APC-7(f)	100 x 19 (4 x 3/4)	0.45 (1 lb)

Ordering Information

11566A Air line extension

11567A Air line extension

11540A Waveguide stand

11544A H-Band, 11545A X-Band,

11546A P-Band, 11547A K-Band, 11548A R-Band

Waveguide holders

MICROWAVE TEST EQUIPMENT

Variable Attenuators and OEM Step Attenuators

Models 375 Series, 382 Series, 393A, 394A, 33300 Series, 33320 Series

399

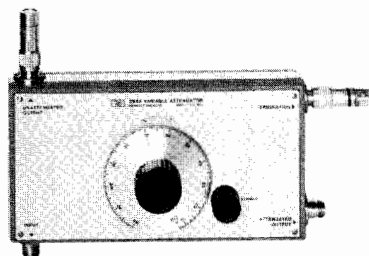

394A

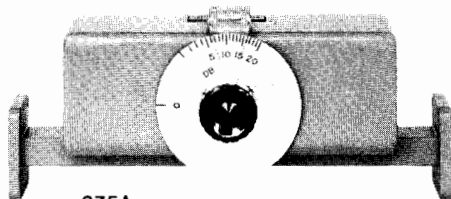

375A

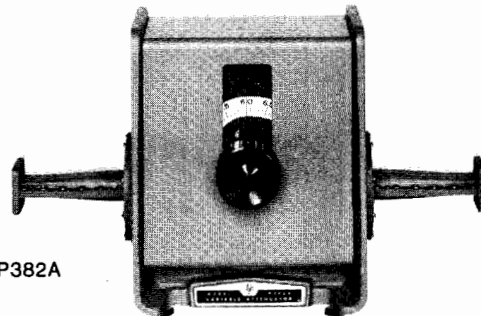

P382A

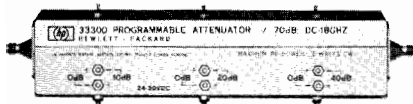

33300A

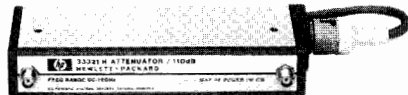

33321H



33323K

393A, 394A Coaxial Variable Attenuator 33300 Series, 33320 Series OEM Step Attenuators

Models 393A and 394A are high power, variable coaxial attenuators for the 0.5 to 2 GHz range. They use the principle of a variable directional coupler to achieve up to 120 dB range with 200 watt power handling capability.

33300 series step attenuators provide wideband programmable signal level control. Magnetic latching solenoids switch individual attenuating elements into and out of contact with a 50-ohm transmission line. C/D models have separate indicator contacts and A/B models have no indicator contacts. Three three-digit connector options (0XY) must be specified. X is the input connector, Y is the output

393A, 394A, 33300 Series, 33320 Series Specifications

Model	Freq Range (GHz)	Mode	Range	Remarks
393A	0.5-1	Manual	5-120 dB Variable	200 W average
394A	1-2	Manual	6-120 dB Variable	200 W average
33300 A/B C/D	dc-18	Prog.	0-70 dB 10 dB steps	A&C models 12-15 V
33301 A/B C/D	dc-18	Prog.	0-42 dB 6 dB steps	B&D models 24-30 V
33304 A/B C/D	dc-18	Prog.	0-11 dB 1 dB steps	Connector options available:
33305 A/B C/D	dc-18	Prog.	0-110 dB 10 dB steps	0: N(f), 1: N(m) 2: 7mm(f), 3: 7mm(m) 5: SMA(f), 6: SMA(m)
33320A B	dc-4 dc-18	Manual	1-11 dB 1dB steps	Specifications identical to 8494 series page 396
33320G H	dc-4 dc-18	Prog.		
33321A B D	dc-4 dc-18 dc-26.5	Manual	0-70 dB 10 dB steps	Specifications identical to 8495 series page 396
33321G H K	dc-4 dc-18 dc-26.5	Prog.		
33322A B	dc-4 dc-18	Manual	0-110 dB 10 db steps	Specifications identical to 8496 series page 396
33322G H	dc-4 dc-18	Prog.		
33323K	dc-26.5	Prog.	0-90 dB 10 dB steps	Specifications identical to 8497K page 396 APC-3.5 only

connector, first digit is always 0. See specifications table for option numbers.

33320 series step attenuators are compact versions of the 8494/5/6/7 bench attenuators on page 396 (same specifications) and are configured for designing into microwave systems and instruments. Manual or electrically-actuated versions are available. The manual models take less than 1.5 square inches of panel space. OEM quantity discounts are available for 33300 and 33320 series.

375 Series, 382 Series Waveguide Attenuators

Operation of these 382 series rotary-vane, continuously-variable attenuators depends on a mathematical law, rather than on the resistivity of the attenuator card. They are direct-reading and provide accurate attenuation from 0 to 50 dB (60 dB for S382C) regardless of temperature and humidity.

375A series variable flap attenuators consist of a short slotted section of waveguide in which a matched resistive strip is inserted.

375A Series 382 Series Specifications

Model	Frequency Range (GHz)	Accuracy	Attenuation Range (dB)	Waveguide & Equivalent Flange
S382C	2.6-3.95	± 1% of reading or 0.1 dB whichever greater ± 2% above 50 dB	0-60	WR 284 UG-584/U
G382A	3.95-5.85	± 2% of reading or 0.1 dB whichever greater	0-50	WR 187 UG-407/U
J382A	5.3-8.2	± 2% of reading or 0.1 dB whichever greater	0-50	WR 137 UG-441/U
H382A	7.05-10.0	± 2% of reading or 0.1 dB whichever greater	0-50	WR 112 UG-138/U
X382A	8.2-12.4	± 2% of reading or 0.1 dB whichever greater	0-50	WR 90 UG-135/U
P382A	12.4-18.0	± 2% of reading or 0.1 dB whichever greater	0-50	WR 62 UG-419/U
K382A	18.0-26.5	± 2% of reading or 0.1 dB whichever greater	0-50	WR 42 UG-597/U
R382A	26.5-40.0	± 2% of reading or 0.1 dB whichever greater	0-50	WR 28 UG-599/U
X375A	8.2-12.4	± 1 dB, ± 2 dB	0-20	WR 90 UG-39/U
P375A	12.4-18	± 1 dB, ± 2 dB	0-20	WR 62 UG-419/U

MICROWAVE TEST EQUIPMENT

Coaxial Fixed Attenuators

Models 8491A/B, 8492A, 8493A/B/C, 8498A, 11581/2/3A/3C, 33340A/B/C

- Flat frequency response
- Low SWR
- Specifications traceable to NBS



11581A

8491A/B, 8492A, 8493A/B/C Fixed Attenuators

Hewlett-Packard coaxial fixed attenuators provide precision attenuation, flat frequency response, low SWR over broad frequency ranges at low prices. Attenuators are available in nominal attenuations of 3-dB and 6-dB, also 10-dB increments from 10 dB to 60 dB. These attenuators are swept-frequency tested to ensure meeting specifications at all frequencies. Calibration points are provided on a nameplate chart attached to each unit.

11581A, 11582A, 11583A/C Attenuator Sets

A set of four Hewlett-Packard attenuators—3, 6, 10 and 20 dB—are furnished in a handsome walnut accessory case. The 11581A set consists of 8491A attenuators; the 11582A set, 8491B attenuators; the 11583A set, 8492A attenuators; and the 11583C set, 8493C attenuators. The set includes calibration reports certified traceable to the National Bureau of Standards, containing both the attenuation and the reflection coefficients for each attenuator at four frequencies for the 11581A (dc, 4, 8, 12.4 GHz) and five frequencies for the 11582A and 11583A (dc, 4, 8, 12.4, 18 GHz). By specifying option 890, calibration data is given at 26 frequencies (11581A) or 42 frequencies (11582A and 11583A). The 11583C set includes option 890 calibration data. See next page for exact frequency lists.

These sets are ideal for calibration labs or where precise knowledge of attenuation and SWR is desired.

8498A High Power Attenuator

The 8498A Option 030 is designed to meet the needs of high power attenuation applications in the RF and microwave frequency range. It is specified from dc to 18 GHz at 25 watts average, 500 watts peak, from dc to 5.8 GHz and 125 watts peak from 5.8 to 18 GHz. Available only in a 30 dB model (option 030), the unit offers low SWR (<1.30 at 18 GHz) and good accuracy (± 1 dB at 18 GHz). The unit also features 'human engineered' cooling fins that prevent operator burns even under continuous maximum input power conditions.

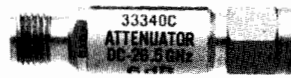

33340C

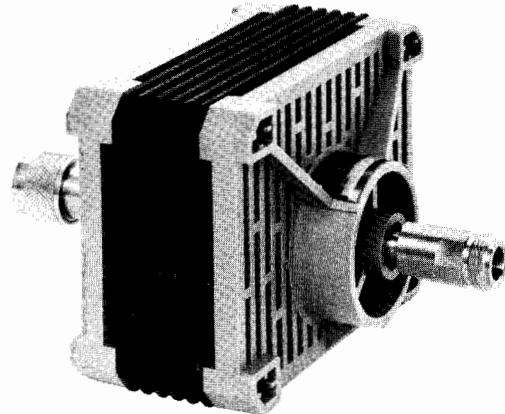

8498A
Option 030

Option 890 Calibration Data

Extensive calibration data is available on HP attenuators at low cost. When option 890 is specified for the fixed attenuators or microwave step attenuators, standardized calibration data in frequency steps no larger than 500 MHz is provided over the frequency range of the units. This data is generated from measurements made on an HP 8542 Automatic Network Analyzer and features excellent accuracy (traceable to NBS) and low cost. Data is given for attenuation and the SWR (reflection coefficient for the 8493C) of each port and is provided in a protective plastic envelope.

Calibration data has important uses in applications such as RF substitution measurements and test system verification. Using the actual calibration data rather than data sheet specifications allows the attenuation uncertainty to be reduced 60% or more. Also, the calculated mismatch uncertainty for a test system is lower if the actual SWR data for the attenuators is used. Similar calibration data is used in HP production areas to verify the performance of manual and automated test systems. For automated system checkout, the calibrated unit is tested and the results are compared to the previously stored calibration data. If the differences are within the measurement uncertainty, proper operation is ensured. For step attenuators, the calibration data can be used in automated test systems to more accurately characterize a device's characteristics. By storing the calibration data for the individual steps, the measurement results can be adjusted by the actual amount of attenuation (for example, when a nominal 10 dB step is actually 9.6 dB).

The calibration data frequencies, prices, and ordering information for fixed attenuators are on the adjacent page, and the same information for step attenuators is on page 402.

33340A/B/C Fixed Attenuators

The 33340A, 33340B and 33340C are coaxial fixed attenuators intended for OEM and systems use. Frequency range specifications are dc—12.4 GHz, dc—18 GHz and dc—26.5 GHz respectively. These OEM attenuators are similar to the 8493 series attenuators.

For more information regarding the 33340 series refer to the data sheet (5952-8279).

Ordering Information

- 33340A Coaxial Fixed Attenuator
Option 890
- 33340B Coaxial Fixed Attenuator
Option 890
- 33340C Coaxial Fixed Attenuator
Option 890



8491A/B series



8492 series



8493A/B/C series

Ordering Example

Include appropriate frequency range/connector and attenuation designations from the ordering example below with every attenuator order.

Calibration Data

Include "Option 890" in addition to attenuation option when ordering calibration data.

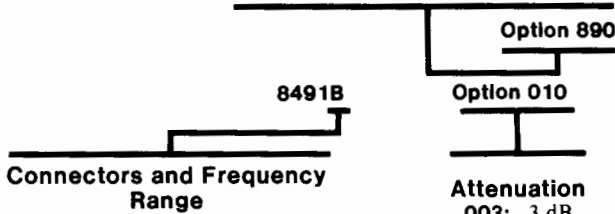

- Connectors and Frequency Range**
- 1A: Type N (m,f), dc-12.4 GHz
 - 1B: Type N (m,f), dc-18 GHz
 - 2A: APC-7, dc-18 GHz
 - 3A: SMA (m,f), dc-12.4 GHz
 - 3B: SMA (m,f), dc-18 GHz
 - 3C: APC 3.5 (m,f), dc-26.5 GHz
 - 8A: Type N (m,f), dc-18 GHz
- 8498 is available in a 30 dB model only

- Attenuation**
- 003: 3 dB
 - 006: 6 dB
 - 010: 10 dB
 - 020: 20 dB
 - 030: 30 dB
 - 040: 40 dB*
 - 050: 50 dB**
 - 060: 60 dB**

* Not available for 8493A/B
** Not available for 8493C

HEWLETT PACKARD
OPTION 890 CALIBRATION REPORT

MODEL: 8492A OPT 810 SERIAL NO: 9061
DATE: 03-22-78 TECHNICIAN: 02157
CALIBRATION SYSTEM: 0542B SYSTEM 8
PORT IDENTIFICATION: WITH LABEL TYPING THE
STEP, PORT 1 IS ON THE LEFT
AND PORT 2 IS ON THE RIGHT.

FREQUENCY (MHz)	ATTENUATION (dB)	SWR	PORT 1	PORT 2
100.00	10.01	1.005	1.005	1.005
500.00	10.01	1.005	1.005	1.005
1000.00	10.01	1.005	1.005	1.005
1500.00	10.02	1.005	1.005	1.005
2000.00	10.03	1.005	1.005	1.005
2500.00	10.02	1.005	1.005	1.005
3000.00	10.02	1.005	1.005	1.005
4000.00	10.02	1.005	1.005	1.005
4500.00	10.01	1.005	1.005	1.005
5000.00	10.02	1.005	1.005	1.005
15500.00	10.04	1.004	1.004	1.004
16000.00	10.00	1.002	1.002	1.002
16250.00	9.99	1.002	1.002	1.002
16500.00	9.98	1.004	1.004	1.004
17000.00	9.94	1.004	1.004	1.004
17250.00	9.98	1.002	1.002	1.002
17500.00	9.97	1.005	1.005	1.005
17750.00	9.97	1.005	1.005	1.005
18000.00	9.97	1.004	1.004	1.004

Option 890

Ordering Information

- 11581A 3, 6, 10, 20 dB 8491A set
Option 890 Calibration Data
- 11582A 3, 6, 10, 20 dB 8491B set
Option 890 Calibration Data
- 11583A 3, 6, 10, 20 dB 8492A set
Option 890 Calibration Data
- 11583C 3, 6, 10, 20 dB 8493C set
Option 890 Calibration Data

8491A/B, 8492A, 8493A/B/C, 8498A, Option 890 Specifications

Model	Frequency Range GHz	SWR Maximum	Maximum input Power	Attenuation Accuracy								Connector
				3 dB (Option 003)	6 dB (Option 006)	10 dB (Option 010)	20 dB (Option 020)	30 dB (Option 030)	40 dB (Option 040)	50 dB (Option 050)	60 dB (Option 060)	
8491A 3-30 dB	dc-12.4	dc-8 GHz: 1.2 8-12.4 GHz: 1.3	2 W Avg. 100 W Peak	±0.3 dB	±0.4 dB	±0.6 dB	±0.6 dB	±1 dB	—	—	—	N(m,f)
40-60 dB				—	—	—	—	±1.5 dB	±1.5 dB	±2 dB		
8491B 3-30 dB	dc-18	dc-8 GHz: 1.2 8-12.4 GHz: 1.3 12.4-18 GHz: 1.5	2 W Avg. 100 W Peak	±0.3 dB	±0.4 dB	±0.6 dB	±0.6 dB	±1 dB	—	—	—	N(m,f)
40-60 dB				±0.4 dB	±0.5 dB	±1.0 dB	—	±1.5 dB	±1.5 dB	±2 dB		
8492A 3-30 dB	dc-18	dc-8 GHz: 1.15 dc-12.4 GHz: 1.25 12.4-18 GHz: 1.35	2 W Avg. 100 W Peak	±0.3 dB	±0.4 dB	±0.6 dB	±0.6 dB	±1 dB	—	—	—	APC-7
40-60 dB				±0.4 dB	±0.5 dB	±1.0 dB	—	±1.5 dB	±1.5 dB	±2 dB		
8493A 3-20 dB	dc-12.4	dc-8 GHz: 1.2 8-12.4 GHz: 1.3	2 W Avg. 100 W Peak	±0.3 dB	±0.4 dB	±0.6 dB	±0.6 dB	—	—	—	—	SMA (m,f)
30 dB				—	—	—	±1 dB	—	—	—		
8493B 3-20 dB	dc-18	dc-8 GHz: 1.2 8-12.4 GHz: 1.3 12.4-18 GHz: 1.5	2 W Avg. 100 W Peak	±0.3 dB	±0.4 dB	±0.6 dB	±0.6 dB	—	—	—	—	SMA(m,f)
30 dB				±0.4 dB	±0.5 dB	±1.0 dB	±1 dB	—	—	—		
8493C	dc-26.5	dc-8 GHz: 1.1 8-12.4 GHz: 1.15 12.4-26.5 GHz: 1.25(1.27 Opt.006)	2 W Avg. 100 W Peak	±0.5 dB	±0.6 dB	±0.3 dB	±0.5 dB	±0.7 dB	±1.0 dB	—	—	APC 3.5 (m,f)
				±1.0 dB	±0.6 dB	±0.5 dB	±0.6 dB	±1.0 dB	±1.3 dB	—		
8498A Option 030	dc-18	dc-2 GHz: 1.1 2-12.4 GHz: 1.2 12.4-18 GHz: 1.35	25 W Avg. 500 W Peak (dc-7 GHz) 125 W Peak (7-18 GHz) 500 Watt-µsec max. per pulse	—	—	—	—	±1 dB	—	—	—	N(m,f)
Option 890 Calibration Data Information		Models		Calibration Frequencies (MHz)								
		8491A, 8493A		100, 500, 1000, every 500 MHz to 12000, 12400. (26 frequencies)								
		8491B, 8492A, 8493B, 8498A, 8493C		Same as above plus 12500 to 16000 8493B, 8498A in 500 MHz steps, 16000 to 18000 in 250 MHz steps. (42 frequencies)								
				every 500 MHz 2 GHz to 18 GHz, every 250 MHz 18 GHz to 26.5 GHz (67 frequencies)								



MICROWAVE TEST EQUIPMENT

Coaxial Step Attenuators

Models 355 Series, 8494/5/6/7 Series, 11713A, 11716A/B, 11717A

- Excellent repeatability
- Manual and programmable
- Calibration data available

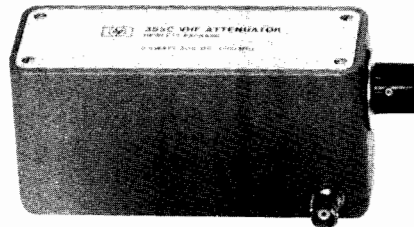

355C

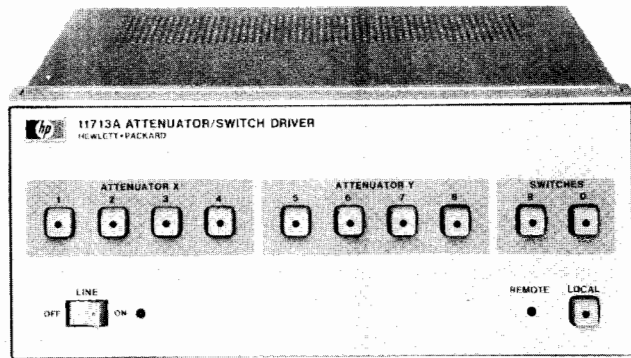

11713A



355C/D/E/F Manual and Programmable Step Attenuators, dc to 1000 MHz

Precision attenuation from dc to 1000 MHz is available with these Hewlett-Packard attenuators. Models 355C/E provide 0 to 12 dB in 1-dB steps and models 355D/F provide 0 to 120 dB in 10-dB steps. For the 355E and 355F models, attenuation programming is done through a 7-pin connector. All standard models are equipped with BNC connectors.

8494A/B/G/H, 8495A/B/D/G/H/K, 8496A/B/G/H, 8497K Manual and Programmable Step Attenuators, dc to 26.5 GHz

Four attenuation ranges are available: 0 to 11 dB in 1-dB steps (Model 8494), 0 to 70 dB in 10-dB steps (Model 8495) and 0 to 110 dB in 10-dB steps (Model 8496) and 0 to 90 dB in 10 dB steps (Model 8497). There is choice of three connectors Type N (f), SMA (f), and APC-7 (APC-3.5 on 8495D/K and 8497K only). Manual and programmable versions are available as well as coverage of three frequency ranges (dc-4 GHz, dc-18 GHz, and dc-26.5 GHz). Calibration data (SWR and attenuation) is available on the 8494/5/6/7 models as option 890. The data is generated by an automatic network analyzer test system and is given for each step of the attenuator at 14 frequencies (dc-4 GHz models), 47 frequencies (dc-18 GHz models), 72 frequencies (dc-26.5 GHz); see frequency lists on next page. This data is very useful for improving measurement accuracy in manual and automated test systems.

Each attenuator consists of three or four attenuation sections connected in cascade. Attenuator sections are inserted and removed by cam-actuated "edge line" contacts. These contacts are gold-plated leaf-springs that ensure long life (over a million steps) and high repeatability (typically 0.03 dB).

The G, H, and K programmable models offer the same high performance as the manual models with the addition of fast switching solenoids. Attenuation programming is done through a 12-pin connector.

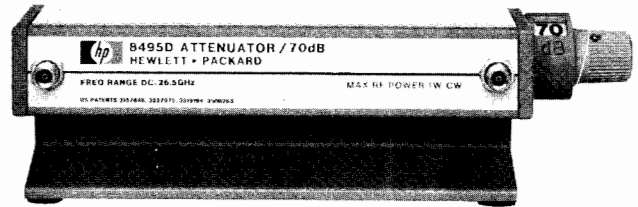

8495D option 004

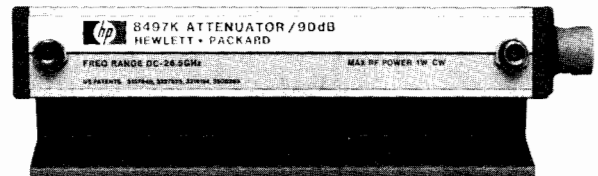

8497K option 004

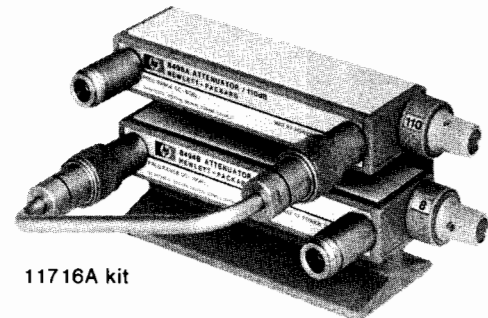

11716A kit

For ease of connection to the driving circuit, each attenuator is provided with a five-foot cable assembly that includes the mating connector. With the HP 11713A Attenuator Driver, the attenuators are easily integrated into a Hewlett-Packard Interface Bus (HP-IB) automated system.

11716A/B Interconnection Kit

Convenient interconnection of 1 dB and 10 dB models is provided with the 11716A/B. These kits provide a rigid RF cable, mounting bracket, and screws to connect any pair of 8494/5/6 attenuators in series (see picture above). Attenuators must be ordered separately.

Equivalent versions of these attenuators for incorporation in equipment (i.e., "OEM") are available under HP model numbers 33320, 33321, 33322 and 33323. See following pages.

11713A Attenuator/Switch Driver

This instrument has all of the necessary features to provide HP-IB control of up to two programmable attenuators of the 8494/5/6/7 or 33320/1/2/3 series and concurrently up to two electro-mechanical switches (e.g., 8761B or 33311 series). Alternatively, the 11713A can be used to supply +24 V common and ten pairs of transistor switches (total current less than 1.25A) to control up to ten relays. The 11713A includes an integral power supply with short circuit protection that can simultaneously provide 125 milliamps at 24 volts to all contacts for control of the attenuators and switches, so no external power supply is needed. For convenience in connecting 8490 or 33320-series attenuators, two 5-foot cables with appropriate connectors are supplied.

A local mode and front panel push buttons allow switches and attenuator sections to be operated manually. Switching time for the drivers is less than 10 milliseconds.

Ordering Information

11713A Attenuator/Switch Driver

11716A Interconnection Kit for Type N (f) Connectors

11716B Interconnection Kit for APC-7 Connectors

11717A Attenuator/Switch Rack Mount Support Kit

How to Order the 8494/5/6/7 Series Attenuators

Each order must include basic model number, suffix letter, and connector option.

Optional calibration data.

8494 A Option 001 Option 890

- | | | |
|----------------------------|--------------------------------|-----------------------|
| 4 (1dB step, 11 dB max) | A (Manual, dc—4 GHz) | 001 (N-Female) |
| 5 (10 dB step, 70 dB max) | B (Manual, dc—18 GHz) | 002 (SMA Female) |
| 6 (10 dB step, 110 dB max) | D (Manual, dc—26.5 GHz)* | 003 (APC-7) |
| 7 (10 dB step, 90 dB max) | G (Programmable, dc—4 GHz) | 004 (APC-3.5 Female)* |
| | H (Programmable, dc—18 GHz) | |
| | K (Programmable, dc—26.5 GHz)* | |
- * Option 004 is only available on 'D' and 'K' models.

355 Series, 8494/5/6/7 Series Specifications

Model and (Switching Mode)	Frequency Range (GHz)	Incremental Attenuation (dB)	SWR Maximum (50 Ω Nominal)	Insertion Loss (0 dB setting)	Attenuation Accuracy	Power Rating, Minimum Life	Solenoid Voltage Speed Power	Size, Shipping Weight	Connector Options Available	
355C (Manual)	dc—1	0—12 1 dB steps	dc—0.25 GHz: 1.2 dc—0.5 GHz: 1.3 dc—1.0 GHz: 1.5	0.11 dB + 1.39 dB/GHz	±0.1 dB @ 1000 Hz ±0.25 dB: dc—0.5 GHz ±0.35 dB: dc—1.0 GHz	0.5 W avg 350 W peak 0.6 million steps	— 15—18 V <65 ms 3.0 W	67 H x 70 W x 152 mm D (2.6" x 2.75" x 6") 1.4 kg (3 lb)	BNC (f) See Note 1	
355E (Programmable)										
355D (Manual)	dc—1	0—120 10 dB steps	dc—0.25 GHz: 1.2 dc—0.5 GHz: 1.3 dc—1.0 GHz: 1.5	0.11 dB + 1.39 dB/GHz	±0.3 dB @ 1000 Hz ±1.5 dB to 90 dB, and ±3 dB to 120 dB @ 1 GHz	0.5 W avg 350 W peak 0.6 million steps	— 15—18 V <65 ms 3.0 W	67 H x 70 W x 152 mm D (2.6" x 2.75" x 6") 1.4 kg (3 lb)	BNC (f) See Note 1	
355F (Programmable)										
8494A (Manual)	dc—4	0—11 1 dB Steps	1.5	0.6 dB + 0.09 dB/GHz	±0.2 dB: 1—2 dB ±0.3 dB: 3—6 dB ±0.4 dB: 7—10 dB ±0.5 dB: 11 dB	1 W avg 100 W peak 10 μs max. 1 million steps	— 20—30 V <20 ms 2.7 W	43 H x 73 W x 159 mm D (1.7" x 2.9" x 6.2") 0.9 kg (2 lb) 43 H x 73 W x 142 mm D (1.7" x 2.9" x 5.6")	001 002 003 See Note 2	
8494G (Programmable)										
8494B (Manual)	dc—18	0—11 1 dB steps	dc—8 GHz: 1.5 dc—12.4 GHz: 1.6 dc—18 GHz: 1.9	0.6 dB + 0.09 dB/GHz	dc—12.4 GHz ±0.3 dB: 1—2 dB ±0.4 dB: 3—4 dB ±0.5 dB: 5—6 dB ±0.6 dB: 7—10 dB ±0.7 dB: 11 dB dc—18 GHz ±0.7 dB: 1—5 dB ±0.8 dB: 6—9 dB ±0.9 dB: 10—11 dB	1 W avg 100 W peak 10 μs max. 1 million steps	— 20—30 V <20 ms 2.7 W	43 H x 73 W x 159 mm D (1.7" x 2.9" x 6.2") 0.9 kg (2 lb) 43 H x 73 W x 142 mm D (1.7" x 2.9" x 5.6")	001 002 003 See Note 2	
8494H (Programmable)										
8495A (Manual)	dc—4	0—70 10 dB steps	1.35	0.4 dB + 0.07 dB/GHz	±1.7% of setting or ±0.4 dB, whichever is greater	1 W avg 100 W peak 10 μs max. 1 million steps	— 20—30 V <20 ms 2.7 W	43 H x 73 W x 130 mm D (1.7" x 2.9" x 5.1") 0.9 kg (2 lb) 43 H x 73 W x 114 mm D (1.7" x 2.9" x 4.5")	001 002 003 See Note 2	
8495G (Programmable)										
8495B (Manual)	dc—18	0—70 10 dB steps	dc—8 GHz: 1.35 dc—12.4 GHz: 1.5 dc—18 GHz: 1.7	0.4 dB + 0.07 dB/GHz	±3%: dc—12.4 GHz ±4%: dc—18 GHz % in dB from Atten. Setting	1 W avg 100 W peak 10 μs max. 1 million steps	— 20—30 V <20 ms 2.7 W	43 H x 73 W x 130 mm D (1.7" x 2.9" x 5.1") 0.9 kg (2 lb) 43 H x 73 W x 114 mm D (1.7" x 2.9" x 4.5")	001 002 003 See Note 2	
8495H (Programmable)										
8495D (Manual)	dc—26.5	0—70 10 dB steps	dc—12.4 GHz: 1.6 12.4—18 GHz: 1.9 18—26.5 GHz: 2.2	0.5 dB + 0.13 dB/GHz	±3%: dc—12.4 GHz ±4%: dc—18 GHz ±7%: dc—26.5 GHz % in dB from Atten. Setting	1 W avg 100 W peak 10 μs max. 1 million steps	— 20-30 V <20 ms 2.7 W	43 H x 52 W x 159 mm D (1.7" x 2.1" x 6.2") 0.9 kg (2 lb) 43 H x 52 W x 168 mm D (1.7" x 2.1" x 6.6")	004 APC-3.5 See Note 2	
8495K (Programmable)										
8496A (Manual)	dc—4	0—110 10 dB steps	1.5	0.6 dB + 0.09 dB/GHz	±1.7% of setting or ±0.4 dB, whichever is greater	1 W avg 100 W peak 10 μs max. 1 million steps	— 20—30 V <20 ms 2.7 W	43 H x 73 W x 159 mm D (1.7" x 2.9" x 6.2") 0.9 kg (2 lb) 43 H x 73 W x 142 mm D (1.7" x 2.9" x 5.6")	001 002 003 See Note 2	
8496G (Programmable)										
8496B (Manual)	dc—18	0—110 10 dB steps	dc—8 GHz: 1.5 dc—12.4 GHz: 1.6 dc—18 GHz: 1.9	0.6 dB + 0.09 dB/GHz	±3%: dc—12.4 GHz +4%: dc—18 GHz % in dB from Atten. Setting	1 W avg 100 W peak 10 μs max. 1 million steps	— 20—30 V <20 ms 2.7 W	43 H x 73 W x 159 mm D (1.7" x 2.9" x 6.2") 0.9 kg (2 lb) 43 H x 73 W x 142 mm D (1.7" x 2.9" x 5.6")	001 002 003 See Note 2	
8496H (Programmable)										
8497K (Programmable)	dc—26.5	0—90 10 dB steps	dc—6 GHz: 1.25 6—12.4 GHz: 1.45 12.4—18.0 GHz: 1.6 18.0—26.5 GHz: 1.8	0.6 dB+ 0.09 dB/GHz	±0.3 dB at 6 GHz 10 dB attenuation to ±2.8 dB at 26.5 GHz 90 dB atten- uation. See Data Sheet 5952-8278 for details.	1 W avg 100 W peak 10 μs max. 1 million steps	5 V or 24V	43 H x 52 W x 143 mm D (1.7" x 2.1" x 5.6") 0.9 kg (2 lb)	004 APC-3.5 See Note 2	
Option 890 Calibration Data Information		Option 890 Frequency List (MHz)				Models				
		DC to 4 GHz Models: 100, 300, 500, 700, 900, 1000, 1250, 1500, 1750, 2000, 2500, 3000, 3500, 4000				DC to 26.5 GHz Models every 500 MHz 2 to 16 GHz every 250 MHz 16 to 26.5 GHz				
		DC to 18 GHz Models: Same as above to 4000 MHz, every 500 MHz to 16000 (plus 12400 MHz), every 250 MHz from 16000 to 18000.				8494A/G, 8496A/G, 33320A/G, 33322A/G 8495A/G, 33321A/G 8494B/H, 8496B/H, 33320B/H, 33322B/H 8495B/H, 33321B/H 8495D/K, 8497K				

Note 1: 355C/D/E/F connector options (BNC (f) standard)
Option 001 N(f)
Option 005 TNC(f)
Option 007 Transistor protection

Note 2: 8494/5/6/7 orders must specify connector option. See ordering example above.
Option 001 N(f)
Option 002 SMA(f)
Option 003 APC-7
Option 004 APC-3.5 (8495D/K, 8497K only)

MICROWAVE TEST EQUIPMENT

Coaxial Single and Dual-Directional Couplers

Models 770 Series, 790 Series, 11691D, 11692D

- Broadband coverage
- High directivity
- Close tracking

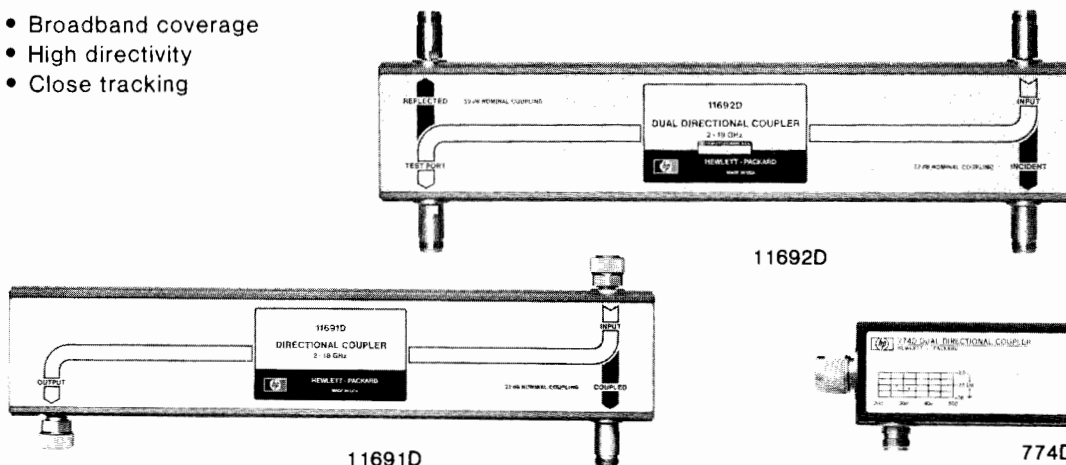

779D Directional Coupler

The HP 779D spans more than two octaves from 1.7 to 12.4 GHz with excellent directivity. With increased coupling factors (typically 24 dB), the 779 is useful down to 500 MHz. Upper frequency usefulness extends to 18 GHz with directivity reduced to about 15 dB. Various connector options are available.

790 Series Directional Couplers (octave bands)

The 790 directional couplers are ultra-flat, high directivity couplers which are ideal for power-monitoring applications in coaxial systems. Output coupling (ratio of output power from main and auxiliary arms) is specified rather than a coupling factor. Thus, no correction factor is required to account for insertion loss in the main arm.

11691D Directional Coupler

The 11691D is an ultra-wide-band single-directional coupler covering 2 to 18 GHz with high directivity. It is useful as a power monitoring or leveling coupler, or for making reflection measurements. Couplers are preferred over broadband bridges in reflectometer applications in situations where the power level of the source is limited, or where simultaneous measurement of return loss and insertion loss is desired.

779D, 790 Series, 11691D Specifications

Model	Frequency Range (GHz)	Mean Output Coupling (dB)	Output Coupling Variation (dB)	Minimum Directivity (dB)	Equivalent ¹ Source Match
779D	1.7-12.4	20 ± 0.5	± 0.75	1.7-4 GHz: 30 4-12.4 GHz: 26	1.2
796D	0.96-2.11	20 ± 0.5	± 0.2	30	1.13
797D	1.9-4.1	20 ± 0.5	± 0.2	26	1.16
798C	3.7-8.3	10 ± 0.3	± 0.3	20	1.25
11691D	2-18	22 Nominal	± 1.0	2-8 GHz: 30 dB 8-18 GHz: 26 dB	1.2
796D-798C Standard connectors Primary Line: N(f), N(m) Auxiliary Arm N(f)					
779D Standard connectors Primary Line N(m) input, N(f) output; auxiliary arm N(f) Option 010: Primary Line N(f) input, N(m) output; auxiliary output N(f) Other options: APC-7 on any or all ports					
11691D Standard connectors Primary line: APC-7, APC-7; Auxiliary Arm: N(f) Option 001: All N(f) Option 005: All APC-7					
¹ Apparent SWR at the output port of a coupler when used in a closed-loop leveling system.					

774D-777D Dual-Directional Couplers (octave bands)

The economical 774D-777D couplers cover frequency spreads of more than two-to-one, each centered on one of the important VHF/UHF bands. With their high directivity and a mean coupling accuracy of ± 0.5 dB, these couplers are ideal for reflectometer applications. Furthermore, the close tracking of the auxiliary arms makes these couplers particularly useful for reflectometers driven by sweep oscillators such as the HP 8350B with its appropriate plug-in. Power ratings are 50 W average, 500 W peak.

778D, 11692D Dual-Directional Couplers (multi-octave bands)

These couplers are ideal for swept-frequency reflectometer testing of broadband coaxial components. The 778D covers 100 MHz to 2 GHz and the 11692D covers 2 to 18 GHz. High directivity and close tracking of the auxiliary arms are featured. Various connector options are available. Both couplers handle 50 W average power. Peak power: 778D, 500 W; 11692D, 250 W.

774D, 775D, 776D, 777D, 778D, 11692D Specifications

Model	Frequency Range (GHz)	Nominal Coupling (dB)	Maximum Coupling Variation (dB)	Minimum Directivity (dB)	SWR Primary Line Maximum (50: Nom.)
774D	0.215-0.450	20	± 1	40	1.15
775D ¹	0.450-0.940	20	± 1	40	1.15
776D ¹	0.940-1.90	20	± 1	40	1.15
777D	1.90-4.0	20	± 0.4	30	1.2
778D	0.10-2.0	20	± 1.5	0.1-1 GHz: 36 ² 1-2 GHz: 32	1.1
11692D	2.0-18.0	22	± 1 incident to test port	2-8 GHz: 30 8-18 GHz: 26 ³	2-12.4 GHz: 1.3 12.4-18 GHz: 1.4
774D-777D Standard connectors Primary Line: N(m), N(f) Auxiliary Arm: N(f), N(f)					
778D Standard connectors Primary Line: N(m), N(f); Auxiliary Arms: N(f), N(f) Option 011: Primary Line, APC-7, N(f) Option 012: Primary Line, N(m), N(f)					
11692D Standard connectors Primary line: N(f), APC-7; Auxiliary Arms: N(f), N(f) Option 001: Primary Line, N(f), N(f) Option 002: Primary Line, N(f), N(m)					
¹ Maximum auxiliary arm tracking: 0.3 dB for 776D; 0.5 dB for 777D ² 30 dB, 0.1 to 2 GHz, input port. ³ 24 dB with Type N connector on the test port.					

MICROWAVE TEST EQUIPMENT

Coaxial Directional Detectors and Waveguide Directional Couplers

Models 780 Series, 752 Series



- Flat frequency response
- Low equivalent source match
- High directivity to > 40 dB

- Low SWR
- Coverage to 40 GHz

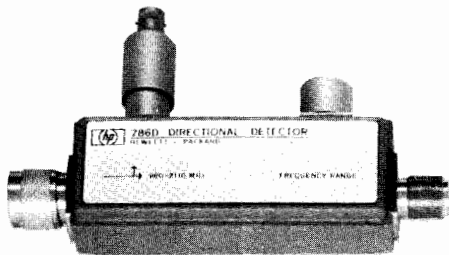

786D

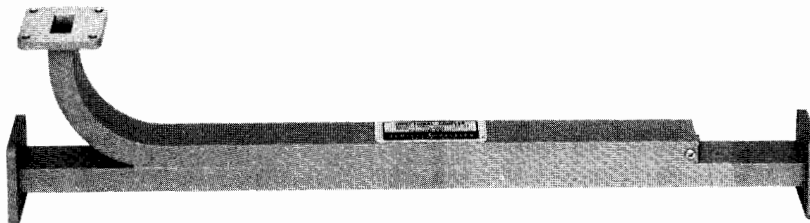

X752A

780 Series Directional Detectors

The 780 series detectors are directional couplers with built-in crystal detectors. The couplers have flat frequency response and good directivity, while the detectors have good frequency response plus high sensitivity. The configuration of the directional detector reduces the number of ambiguities over the standard system of separate coupler and detector and makes possible tighter correlation between main-arm power and detected signal. The directional detector is well suited for sweep oscillator leveling and can also be used to monitor power with a voltmeter or oscilloscope.

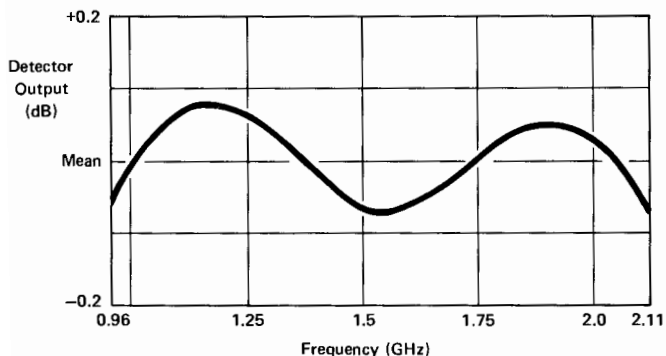

Figure 1. Typical 786D Frequency Response.

780 Series Specifications Standard Connectors

Output: all models, N(f)
Input: 786D-788C, N(m); 789C, N(f)

Model	Frequency Range (GHz)	Frequency ¹ Response	Equivalent ² Source Match
786D	0.96-2.11	±0.2	1.13
787D	1.9-4.1	±0.2	1.16
788C	3.7-8.3	±0.3	1.25
789C	8-12.4	±0.5	1.25

¹Includes coupler and detector variation with frequency as read on a meter calibrated for square-law detector (e.g., HP 415E).

²Apparent SWR at the output port of the directional detector when used in a closed-loop leveling system.

752 Series Waveguide Directional Couplers

The HP 752 series couplers are specified to meet a wide variety of microwave applications. Every coupler has a minimum directivity of 40 dB over its entire frequency range. Each coupler is swept-frequency tested to ensure that the main guide SWR and directivity specifications are accurate. Performance characteristics are unaffected by humidity, temperature, and time, making these units especially useful in microwave "standards" measurements.

The 752 couplers are an essential part of many waveguide measurement systems. Attenuation measurements, reflectometer setups, power measurements, source leveling and network analysis are just a few areas in which these couplers are used.

752 Series Specifications

Model	Frequency Range (GHz)	Nominal Coupling (dB)	Mean Coupling Accuracy (dB)	Maximum Coupling Variation (dB)	Minimum Directivity (dB)	Waveguide & Flange
H752A	7.05-10.0	3	±0.4	±0.5	40	WR112 UF-138/U
H752C	7.05-10.0	10	±0.4	±0.5	40	
H752D	7.05-10.0	20	±0.4	±0.5	40	
X752A	8.2-12.4	3	±0.4	±0.5	40	WR90 UG-135/U
X752C	8.2-12.4	10	±0.4	±0.5	40	
X752D	8.2-12.4	20	±0.4	±0.5	40	
P752A	12.4-18.0	3	±0.4	±0.5	40	WR62 UG-419/U
P752C	12.4-18.0	10	±0.4	±0.5	40	
P752D	12.4-18.0	20	±0.4	±0.5	40	
K752A	18.0-26.5	3	±0.7	±0.5	40	WR42 UG-595/U
K752C	18.0-26.5	10	±0.7	±0.5	40	
K752D	18.0-26.5	20	±0.7	±0.5	40	
R752A	26.5-40.0	3	±0.7	±0.5	40	WR28 UG-599/U
R752C	26.5-40.0	10	±0.7	±0.5	40	
R752D	26.5-40.0	20	±0.7	±0.6	40	

MICROWAVE TEST EQUIPMENT

Coaxial Crystal Detectors

Models 420C, 423A/B, 8470A/B, 8471A, 8472A, 8473B/C, 33330B/C

- Flat frequency response
- High burnout protection

- Low SWR
- Field replaceable detector elements



33330B



8470B Opt 012



423A



8470A



423B



8470B



8472A



8471A

423B, 8470B, 8473B/C, 33330B/C Low Barrier Schottky (LBS) Detectors

The low-barrier Schottky (LBS) detectors are a state-of-the-art addition to the HP family of high performance detectors. Various models provide coverage to 12.4, 18, and 26.5 GHz and input connectors are Type N, APC-7, or APC-3.5 depending on frequency range. Output connector is BNC (f) except for the 33330B/C (SMC).

Matched pairs (Opt 001), square law load (Opt 002), and positive polarity output (Opt 003) are available for most models.

423A, 8470A, 8471A, 8472A Point-Contact Detectors

These point-contact detectors have been widely used for many years and provide high performance at an economical price. The 8470A, 8470A Opt 012, and 8472A provide APC-7, Type N, and SMA connector versions to 18 GHz. Matched pairs are available for applications requiring close detector tracking, and all but the 8472A can be supplied with video loads for optimum conformance to square law.

Coaxial Crystal Detector Specifications

Model	Frequency Range (GHz)	Frequency Response (dB)	SWR Maximum (50Ω Nom.)	Low Level Sensitivity	Maximum Input (Peak or Average)	Short-Term Maximum Input (<1 min.)	Option 001 Matched Pair (order 2 units for each pair)	Options Available	Input Connector	Output Connector
420C	0.01-12.4 Point Contact	±2	2.0	>0.15 mV/ μW	100 mW	0.1 watt	±1 dB	001 003	N (m)	BNC (f)
423B	0.01-12.4 LBS	±0.2/octave to 8 GHz ±0.3 overall	<1.15 to 4 GHz <1.3 to 12.4 GHz	>0.5 mV/ μW	200 mW	1 watt	±0.2 dB to 12.4 GHz	001 002	N (m)	BNC (f)
423A	0.01-12.4 Point Contact	±0.2/octave to 8 GHz ±0.5 overall	<1.2 to 4.5 GHz <1.35 to 7 GHz <1.5 to 12.4 GHz	>0.4 mV/ μW	100 mW	0.1 watt	±0.2 dB to 8 GHz ±0.3 dB to 12.4 GHz	001 002 003	N (m)	BNC (f)
8470B	0.01-18.0 LBS	±0.2/octave to 8 GHz ±0.3 to 12.4 GHz ±0.6 to 18 GHz	<1.15 to 4 GHz <1.3 to 15 GHz <1.4 to 18 GHz	<0.5 mV/ μW	200 mW	1 watt	±0.2 dB to 12.4 GHz ±0.3 dB to 18 GHz	001 002 003	APC-7	
8470B Opt 012									N (m)	BNC (f)
8470A	0.01-18.0 Point Contact	±0.2/octave to 8 GHz ±0.5 to 12.4 GHz ±1.0 to 18 GHz	<1.2 to 4.5 GHz <1.35 to 7 GHz <1.5 to 12.4 GHz <1.7 to 18 GHz	>0.4 mV/ μW	100 mW	0.1 watt	±0.2 dB to 8 GHz ±0.3 dB to 12.4 GHz ±0.6 dB to 18 GHz	001 002 003	APC-7	
8470A Opt 012									N (m)	BNC (f)
8473B	0.01-18.0 LBS	±0.2/octave to 8 GHz ±0.6 to 18 GHz	<1.2 to 12.4 GHz <1.5 to 18 GHz	>0.5 mV/ μW	200 mW	1 watt	±0.2 dB to 12.4 GHz ±0.3 dB to 18 GHz	001 003	APC-3.5 (m)	BNC (f)
8473C	0.01-26.5 LBS	±0.6 to 20 GHz ±1.5 with a -3.5 dB slope, 20 to 26.5 GHz	<1.2 to 4 GHz <1.5 to 18 GHz <2.2 to 26.5 GHz	>0.5 mV/μW to 18 GHz >0.18 mV/ μW to 26.5 GHz	200 mW	1 watt	±0.2 dB to 12.4GHz ±0.3 dB to 18 GHz ±0.5 dB to 26.5 GHz	001 003	APC-3.5 (m)	BNC (f)
8472A	0.01-18.0 Point Contact	±0.2/octave to 8 GHz ±0.5 to 12.4 GHz	<1.2 to 4.5 GHz <1.35 to 7 GHz <1.5 to 12.4 GHz <1.7 to 18 GHz	>0.4 mV/ μW	100 mW	0.1 watt	±0.2 dB to 8 GHz ±0.3 dB to 12.4 GHz ±0.6 dB to 18 GHz	001 003	SMA (m)	BNC (f)
33330B	0.01-18.0 LBS	±0.6	<1.5	>0.5 mV/ μW	200 mW	1 watt	±0.3 dB	001 003	APC-3.5 (m)	SMC (m)
33330C	0.01-26.5 LBS	±0.6 to 20 GHz ±1.5 with a -3.5 dB slope 20 to 26.5 GHz	<1.5 to 18 GHz <2.2 to 26.5 GHz	>0.5 mV/μW to 18 GHz Degrades to 0.18 mV/μW at 26.5 GHz	200 mW	1 watt	±0.3 dB to 18 GHz ±0.5 dB to 26.5 GHz	001 003	APC-3.5 (m)	SMC (m)
8471A	100 kHz-1.2 GHz Point Contact	±0.6 (typical) ±0.1/100 MHz	1.3 (typical) 50Ω	>0.35 mV/ μW	3 Vrms	3 Vrms	No	004 005 006	BNC (m)	BNC (f)

Options

Option 001: Matched response. Must order two (2) option 001's for a pair of detectors with matched frequency response.

Option 002: Optimum square law load.

Option 003: Positive polarity output.

Model 8471A

004: positive output

005: 75 ohm negative output

006: 75 ohm positive output

N/C

Point Contact Detectors				Low Barrier Schottky Diodes			
Model	Opt. 001	Opt. 002	Opt. 003	Model	Opt. 001	Opt. 002	Opt. 003
420C		n/a	N/C	423B			
423A			N/C	8470B			
8470A			N/C	8472B		n/a	
8472A		n/a	N/C	8473B		n/a	
				8473C		n/a	
				33330B		n/a	
				33330C		n/a	

MICROWAVE TEST EQUIPMENT

Waveguide Crystal Detectors; Frequency Meters

Models 422A, 424A, 532 Series, 536A, 537A

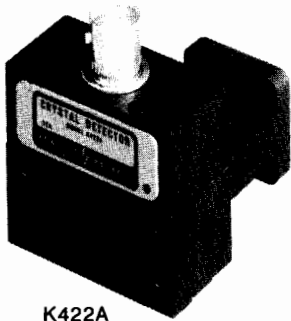

K422A

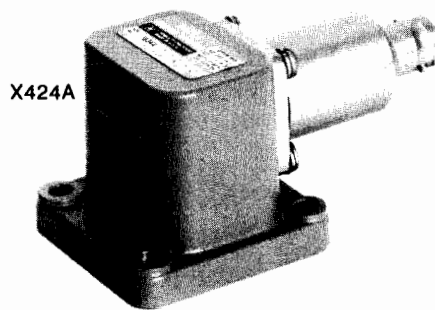

X424A

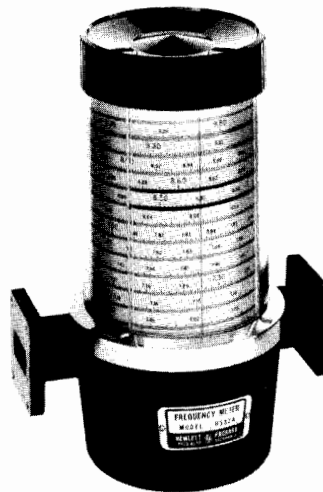

H532A

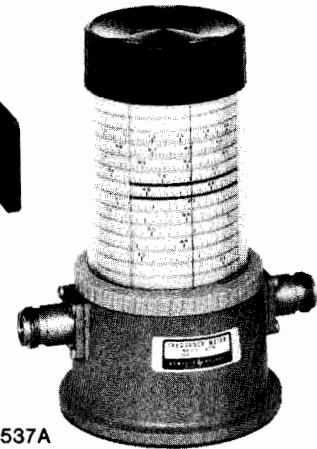

537A

422 Series, 424 Series Crystal Detectors

The 422A and 424A families of crystal detectors combine high sensitivity with flat frequency response and low SWR to provide waveguide band coverage from 7 to 40 GHz. They deliver between 0.2 and 0.4 mV/ μ W output at low level and handle 100 mW peak input. SWR ranges from 1.35 at H-band to 3 at R-band.

For reflectometer applications in which both flat frequency response and square-law characteristics are important, these models can be supplied as matched pairs (Option 001) and an optimum square-law load (Option 002).

422 Series, 424 Series Waveguide Crystal Detector Specifications

Model	Frequency Range (GHz)	Frequency Response (dB)	Option 001 Matched Response (dB)	Option 003 Positive Polarity Output Available	Waveguide & Equivalent Flange
H424A	7.05-10.0	± 0.2	± 0.2 dB	Yes	WR112 UG-138/U
X424A	8.2-12.4	± 0.3	± 0.3 dB	Yes	WR90 UG-135/U
P424A	12.4-18.0	± 0.5	± 0.5 dB	Yes	WR62 UG-419/U
K422A	18.0-26.5	± 2	± 1 dB	N/A	WR42 UG-595/U
R422A	26.5-40.0	± 2	± 1 dB	N/A	WR28 UG-599/U

Option 001: Matched response. Must order two (2) option 001's for a pair of detectors with matched frequency response.

Option 002: optimum square-law load.

Option 003: positive polarity output.

Model	Opt. 001	Opt. 002	Opt. 003
H424A			N/C
K422A			N/A
P424A			N/C
R422A			N/A
X424A			N/C

532 Series, 536A, 537A Frequency Meters

These direct-reading frequency meters measure frequencies from 7 to 40 GHz in waveguide and from 960 MHz to 12.4 GHz in coax quickly and accurately. Their long scales and numerous calibration marks provide high resolution which is particularly useful when measuring frequency differences or small frequency changes. Frequency is read directly in GHz so neither interpolation nor charts are required.

The instruments comprise a special transmission section with a high-Q resonant cavity which is tuned by a choke plunger. A 1 dB or greater dip in output indicates resonance; virtually full power is transmitted off resonance. Overall accuracy of each frequency meter includes allowance for 0 to 100 percent relative humidity and temperature variation from 13 to 33°C.

532 Series, 536A and 537A Specifications

Model	Frequency Range (GHz)	Overall Accuracy (%)	Calibration Increment (MHz)	W/G-Coax Equivalent Flange (Connector)
536A	0.96-4.20	0.96 to 1 GHz: 0.22 1 to 4.2 GHz: 0.17	2	Coax Type N(f)
537A	3.7-12.4	0.170	10	Coax Type N(f)
H532A	7.05-10.0	0.075	2	WR112 UG-138/U
X532B	8.20-12.4	0.080	5	WR90 UG-39/U
P532A	12.4-18.0	0.100	5	WR62 UG-419/U
K532A	18.0-26.5	0.110	10	WR42 UG-595/U
R532A	26.5-40.0	0.120	10	WR28 UG-599/U



MICROWAVE TEST EQUIPMENT

Slotted Lines, Carriage, Probes, SWR Meter

Models 415E, 442B, 444A, 447B, 809C, 810B Series, 816A

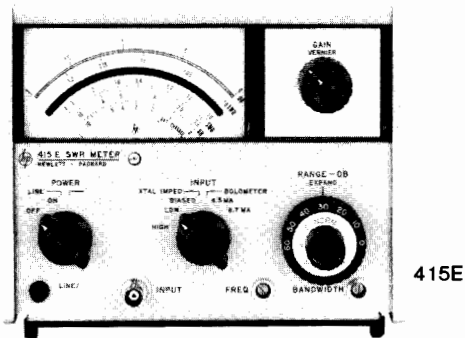

415E

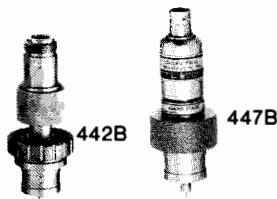

442B

447B

415E SWR Meter

Model 415E SWR Meter is a low noise, 1000 Hz tuned amplifier and voltmeter, calibrated in dB and SWR. Designed for use with square law detectors, it measures SWR, attenuation, and gain directly from metered scales, or drives an X-Y recorder for RF substitution measurements. Front panel INPUT switch selects unbiased low (50-200 Ω) or high (2500-10,000 Ω) impedance crystal, biased crystal (1 V into 1 K Ω), or low or high current bolometer (4.5 or 8.7 mA \pm 3% into 200 Ω).

An internal precision 60 dB attenuator allows the 415E to operate over a 70 dB range in 10 or 2 dB steps, with \pm 0.05 dB accuracy for a 10 dB step; maximum cumulative error between any two 10 dB steps is \pm 0.1 dB. Sensitivity is 0.15 μ V rms for full scale deflection at maximum bandwidth (1 μ V rms on high impedance crystal input).

Continuously adjustable bandwidth can be adjusted from 15 Hz for maximum sensitivity at CW frequencies to 130 Hz for swept frequency uses. An optional rechargeable battery pack provides up to 36 hours of continuous operation for portable use. Weight: Net 4 kg (9 lbs). Shipping 5.8 kg (13 lbs). Power: 115-230 V \pm 10%, 50-400 Hz, 1 VA.

809C Slotted Line Carriage

The 809C carriage operates with the 816A coaxial slotted section and four 810B waveguide slotted sections. It is compatible with the 442B, 444A, and 447B coaxial probes. The carriage has a centimeter scale with a vernier reading to 0.1 mm, and provision is also made for mounting a dial gauge if more accurate probe position reading is required.

810B Series, 816A Slotted Sections

810B waveguide and 816A coaxial slotted sections are used with the 809C carriage. The 810B waveguide sections accept the 444A untuned probe or the 442B probe plus 440A tuned detector. The 816A coaxial line accepts the 447B probe.

810B Series, 816A Specifications

Model	Frequency Range (GHz)	SWR Residual	WG & Flange or Coax Conn.	Remarks
H810B	7.05-10.0	1.01	WR 112 UG-138/U	Use with 809C Carriage, 444A or 442B + 440A Probes
X810B	8.2-12.4	1.01	WR 90 UG-135/U	
P810B	12.4-18.0	1.01	WR 62 UG-419/U	Use with 809C carriage 444A Probe
816A	1.8-18.0	1.02-1.04	Coaxial APC-7 N(f)	11512A N (m) Short 11565A APC-7 Short furnished. Use with 809C Carriage 447B Probe
Opt 011			Both APC-7	
Opt 022			N(m), N(f)	

440A, 442B, 444A, 447B Probes/Adapters

440A is a single stub-tuned detector (1N21 crystal not supplied) for 2.4-12.4 GHz, to be used on the 442 broadband probe. 442B fits the 809C carriage and provides sampled RF at a Type N jack.

444A is an untuned probe for 2.6-18 GHz for use with the 809C carriage or other $\frac{3}{4}$ inch (19 mm) mounting hole and the 810B waveguide sections. 447B is similarly used with the 809C and the 816A coaxial section for 1.8 to 18 GHz.

Ordering Information

440A Detector mount

442B RF probe

444A Untuned probe

447B Detector probe

809C Slotted line carriage

415E SWR Meter

Opt 001: rechargeable battery installed

Opt 002: rear panel input connector



- Precision loads and shorts for measurements to 40 GHz

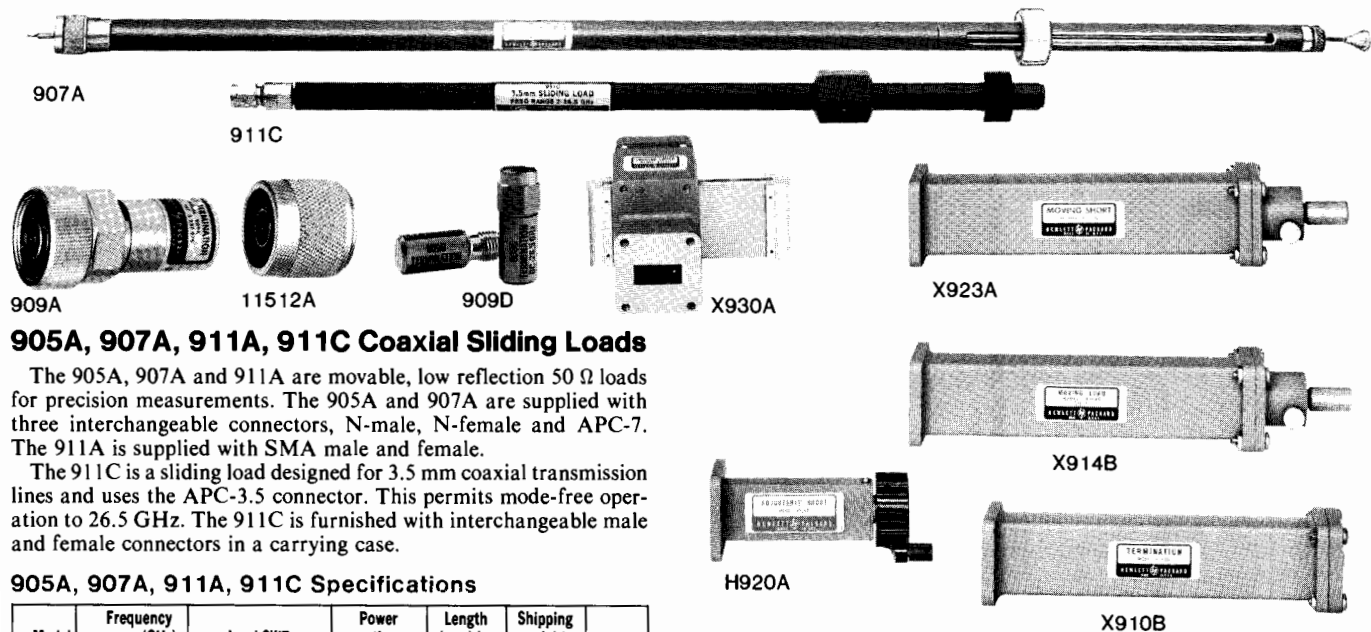

905A, 907A, 911A, 911C Coaxial Sliding Loads

The 905A, 907A and 911A are movable, low reflection 50 Ω loads for precision measurements. The 905A and 907A are supplied with three interchangeable connectors, N-male, N-female and APC-7. The 911A is supplied with SMA male and female.

The 911C is a sliding load designed for 3.5 mm coaxial transmission lines and uses the APC-3.5 connector. This permits mode-free operation to 26.5 GHz. The 911C is furnished with interchangeable male and female connectors in a carrying case.

905A, 907A, 911A, 911C Specifications

Model	Frequency range (GHz)	Load SWR	Power rating	Length (mm) in.	Shipping weight
905A	1.8-18	1.05	1 W avg. 5 kW pk	(440) 17.25	(1.4 kg) 3 lb
907A	1-18	1.1, 1-1.5 GHz; 1.05, 1.5-18 GHz	1 W avg. 5 kW pk	(778) 30.62	(4.1 kg) 9 lb
911A	2-18	1.1, 2-4 GHz; 1.05, 4-18 GHz	1 W avg. 5 kW pk	(380) 14.87	(1.4 kg) 3 lb
911C	2-26.5	1.2, 2-10 GHz; 1.07, 10-26.5 GHz	1 W avg. 5 kW pk	(266) 10.5	(1.7 kg) 3.8 lb

908A, 909A/C/D Coaxial Fixed Terminations

The 908A, 909A and 909D terminations are low reflection loads for terminating 50 Ω coaxial systems in their characteristic impedance. The 909C is a precision ultra low reflection termination intended for use as a calibration standard.

908A, 909A/C/D Specifications

Model	Frequency Range (GHz)	Impedance (ohms)	SWR	Power Rating	Connector
908A	dc-4	50	1.05	½ W avg. 1 kW pk	N male
909A	dc-18	50	1.05: 0-4 GHz 1.1: 4-12.4 GHz 1.25: 12.4-18 GHz	2 W avg. 300 W pk	APC-7
909A Option 012 Option 013	dc-18	50	1.06: 0-4 GHz 1.11: 4-12.4 GHz 1.3: 12.4-18 GHz	2 W avg. 300 W pk	Opt. 012 N male Opt. 013 N female
909C	dc-2	50	1.005	½ W avg. 100 W pk	APC-7
909C Option 012 Option 013	dc-2	50	1.01	½ W avg. 100 W pk	Opt. 012 N male Opt. 013 N female
909D	dc-26.5	50	1.07: dc-4 GHz 1.12: 4-12.4 GHz 1.22: 12.4-26.5 GHz	2 W avg.	APC-3.5 male
909D Option 011	dc-26.5	50	1.07: dc-4 GHz 1.12: 4-12.4 GHz 1.22: 12.4-26.5 GHz	100 W pk	Opt. 011 APC-3.5 female

920A/B, X923A, X930A Waveguide Shorts

The 920A/B are movable shorts, adjustable through at least half a wavelength at the low end of the band. The X923A is also a movable short, but is adjustable through about two wavelengths at 8.2 GHz.

The X930A is a shorting switch. SWR is less than 1.02 in the "through" position and greater than 124 in the "short" position.

920A/B, X923A, X930A Specifications

Model	Frequency Range (GHz)	Waveguide Size EIA
H920A	7.05-10.0	WR112
X923A	8.2-12.4	WR90
P920B	12.4-18	WR62
K920B	18.0-26.5	WR42
R920B	26.5-40.0	WR28
X930A	8.2-12.4	WR90

910A/B, 914A Waveguide Fixed and Movable Terminations

The 910A/B are fixed terminations for waveguide systems. The 914A/B are similar to the 910A/B, except that their absorptive elements are movable and locking plungers control the position of the elements.

910A/B, 914A/B Specifications

Model	Frequency Range (GHz)	SWR	Power Rating	Type	Waveguide Size (EIA)
H910A	7.05-10.0	1.02	1 watt	fixed	WR112
X910B	8.2-12.4	1.015	1 watt	fixed	WR90
P910A	12.4-18	1.02	1 watt	fixed	WR62
H914A	7.05-10.0	1.01	1 watt	sliding	WR112
X914B	8.2-12.4	1.01	1 watt	sliding	WR90
P914A	12.4-18	1.01	½ watt	sliding	WR62
K914B	18-26.5	1.01	½ watt	sliding	WR42
R914B	26.5-40	1.01	½ watt	sliding	WR28

11511A, 11512A, 11565A Coaxial Shorts

These shorts are used for establishing measurement planes for known reflection phase and magnitude in 50 Ω and 75 Ω coaxial systems for various connectors.

Ordering Information

- 11511A N-female short (50 ohm)
- 1250-1531 N-female short (75 ohm)
- 11512A N-male short (50 ohm)
- 1250-1530 N-male short (75 ohm)
- 11565A APC-7 short (50 ohm)
- 0960-0054 SMA-female short (50 ohm)
- 0960-0055 SMA-male short (50 ohm)

MICROWAVE TEST EQUIPMENT

Filters, Mixers, and Tuners

Models 360 Series, 362 Series, 870A, P932A, 934A, 10514A, 10534A

- Effective elimination of undesirable signals
- Low insertion loss through passband

- Correct waveguide discontinuities
- Measure microwave frequencies



X362A

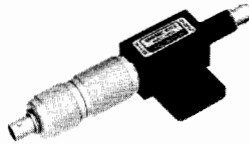

P932A



10514A



360D

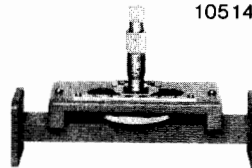

X870A

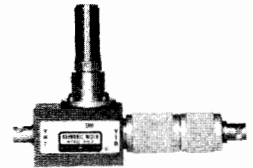

934A

360 Series Coaxial Low Pass Filters, 362 Series Waveguide Low Pass Filters

These Hewlett-Packard low-pass filters facilitate microwave measurements by eliminating undesirable signals (such as harmonics) from the measurement system. Suppression of such signals is particularly important in applications such as broadband reflection and transmission measurements or slotted line measurements, where harmonics generated by the signal source could otherwise impair measurement accuracy.

X870A, P870A Waveguide Slide-Screw Tuners

Waveguide slide-screw tuners are used primarily for correcting discontinuities or for "matching" waveguide systems. X870A covers 8.2-12.4 GHz in WR 90 waveguide and P870A covers 12.4-18.0 GHz in WR 62 waveguide. Both can correct a SWR of 20 to a value of 1.02, with a maximum loss of 2 dB.

934A, P932A Harmonic Mixers

These mixers can be used for frequency measurements and phase lock applications from 2 to 18 GHz. Both accept stable VHF signals from 100 to 1000 MHz and provide broadband, high sensitivity mixing with microwave signals. 934A handles coaxial inputs from 2 to 12.4 GHz while P932A mixes signals from 12.4 to 18 GHz in WR 62 waveguide. With 0 dBm input signal 934A provides 1.4 mV p-p output and P932A 0.4 mV p-p.

10514A, 10534A Double Balanced Mixers

These mixers are excellent in a variety of mixing applications as well as AM, pulse, and square-wave modulation applications. The careful balancing of the hot carrier diodes in the 10514A and 10534A provides excellent output suppression of the local oscillator and input frequencies. Frequency ranges are 0.2-500 MHz for the 10514A and 0.05-150 MHz for the 10534A. Connectors are BNC.

Ordering Information

X870A Waveguide tuner

P870A Waveguide tuner

P932A Waveguide harmonic mixer

934A Coaxial harmonic mixer

10514A Double Balanced Mixer (0.2-500 MHz)

10534A Double Balanced Mixer (0.05-150 MHz)

360 Series Coaxial Filter Specifications

Model	Cut-off Frequency (MHz)	Insertion Loss	Rejection	Impedance	VSWR Maximum	Connectors	Overall Length mm (in)	Shipping Weight kg (lb)
360A	700	Less than 1 dB below 0.9 times cut-off frequency	Greater than 50 dB at 1.25 times cut-off frequency	50 Ω	<1.6 to within 100 MHz of cut-off	N (m, f)	276 (10.9)	0.9 (2)
360B	1200			50 Ω		N (m, f)	183 (7.2)	0.9 (2)
360C	2200			50 Ω	<1.6 to within 200 MHz of cut-off	N (m, f)	274 (10.8)	0.9 (2)
360D	4100			50 Ω	<1.6 to within 300 MHz of cut-off	N (m, f)	187 (7.4)	0.45 (1)

362 Series Waveguide Low Pass Filter Specifications

Model	Passband (GHz)	Stopband (GHz)	Passband Insertion Loss	Stopband Rejection	SWR Maximum	Waveguide Size	Equivalent Flange	Length mm (in)	Shipping Weight kg (lb)
X362A	8.2-12.4	16-37.5	<1 dB	At least 40dB	1.5	WR 90	UG-39/U	136 (5.4)	0.9 (2)
M362A	10.0-15.5	19-47			1.5	WR 75	Cover	114 (4.5)	0.9 (2)
P362A	12.4-18.0	23-54			1.5	WR 62	UG-419/U	94 (3.7)	0.37 (13 oz)
K362A ¹	18.0-26.5	31-80			1.5	WR 42	UG-595/U	64 (2.5)	0.15 (5.3 oz)
R362A ¹	26.5-40.0	47-120	<2 dB	>35 dB	1.8	WR 28	UG-599/U	42 (1.7)	0.11 (4 oz)

¹Circular Flange Adapters available: For K-Band, specify 11515A (UG-425/U). For R-Band, specify 11516A (UG-381/U).

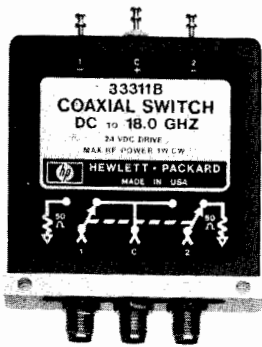

33311B

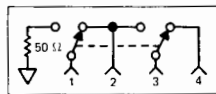

33311B-C04

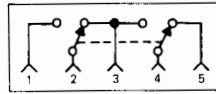

33311B-C05
Wiring Diagrams

PORT 1 PORT 2

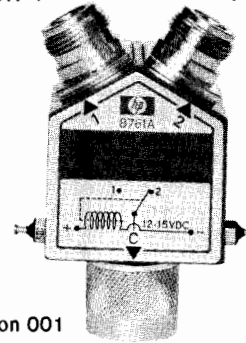

8761A Option 001

PORT C

33311B/C Coaxial Switches

The 33311B and 33311C are high-isolation, single-pole, double-throw coaxial switches with excellent reliability, repeatability, and performance. They are designed for use in 50 Ω systems and have internally-switched 50 Ω terminations which results in all ports being matched. The switches are controlled by magnetic latching solenoids and switching current is automatically cut off when switching is complete.

8761A/B Coaxial Switches

The 8761 is a single-pole, double-throw coaxial switch with low standing-wave ratio, low insertion loss, and excellent isolation from dc to 18 GHz. Mechanically, the switch is a break-before-make type controlled by a latching solenoid. Any of seven coaxial connectors, or a 50-ohm termination, may be specified for each port.

33311B-C04/C05 Coaxial Switches

Models 33311B-C04/C05 are 4-port and 5-port coaxial switches, which can be connected as "transfer switches" to insert or remove a component from a signal path. In a test system, they can also switch in a device to be tested or provide the thru-connection/cross-connection functions in a microwave matrix switch. The 33311B-C04 has the additional feature of terminating port 1 in 50 ohms when it is inactive. In the label schematics above, the signal path connects to ports 2 and 3 while the device to be inserted connects between ports 1 and 4. Insertion loss, SWR, isolation, and solenoid drive power are all similar to the 33311B.

HP-IB Compatible

The 33311B/C and the 8761A/B switches can be remotely controlled by HP-IB with either the 11713A or the 59306A. The 11713A Attenuator Switch Driver is referenced on page 402. The 59306A HP-IB Relay Actuator is referenced on page 38.

33311B/C Specifications

Frequency Range

33311B: dc to 18 GHz.

33311C: dc to 26.5 GHz.

SWR (50 ohm characteristic impedance)

33311B: <1.25, dc to 12.4 GHz; 1.5, 12.4 to 18 GHz.

33311C: <1.3, dc to 10 GHz; <1.5, 10 to 16 GHz; <2.3, 16 to 26.5 GHz.

Insertion Loss

33311B: <0.25 dB, dc to 2 GHz; <0.5 dB, 2 to 18 GHz.

33311C: <0.25 dB, dc to 2 GHz; <0.5 dB, 2 to 10 GHz; <0.8 dB, 10 to 16 GHz; <1.4 dB, 16 to 26.5 GHz.

Isolation

33311B: >90 dB, dc to 18 GHz.

33311C: >90 dB to 12.4 GHz; >85 dB, 12.4 to 18 GHz; >50 dB, 18 to 26.5 GHz.

RF Connectors

33311B: (3) SMA female.

33311C: (3) APC-3.5 female (SMA compatible).

Power: 1 W average, 100 W peak (10 μs duration).

Solenoid voltage (dc or pulsed): 24 volts. Diode protected to reduce voltage transients.

Switching speed: <30 ms (including settling time).

Life: >1,000,000 switchings.

Size: 54 H x 53 W x 14 mm D (2.13" x 2.13" x 0.56") excluding connectors and solenoid terminals.

Weight: net, 88 gm (0.2 lb). Shipping, 220 gm (0.5 lb).

Options: 011, 5-volt solenoid voltage (only on 33311B).

8761A/B Specifications

Characteristic impedance: 50 ohms.

Frequency range: dc to 18 GHz.

Standing-Wave Ratio

Frequency	SWR		
	7-mm	N	SMA
dc-12.4 GHz	1.15 (1.20)	1.20 (1.25)	1.30 (1.30)
dc-18 GHz	1.20 (1.25)	1.25 (1.30)	1.35 (1.35)

SWR in parentheses applies to switch with built-in termination

Insertion loss: <0.5 dB, dc to 12.4 GHz; <0.8 dB, dc to 18 GHz.

Isolation: >50 dB, dc to 12.4 GHz; >45 dB, dc to 18 GHz.

Power: 10 W average, 5 kW peak; built-in termination rated at 2 W average, 100 W peak.

Switching energy: 1.5 W for 20 ms (permanent magnet latching).

Solenoid voltages (dc or pulsed): 12 to 15 V, 8761A; 24 to 30 V, 8761B.

Switching speed: 35 to 50 ms (including settling time).

Life: >1,000,000 switchings.

Size: 41 H x 38 W x 38 mm D (1.6" x 1.5" x 1.5") excluding connectors and solenoid terminals.

Weight: net, 140 to 220 gm (0.3 to 0.5 lb). Shipping, 220 to 300 gm (0.5 to 0.7 lb).

How to Order 8761A/B Switches

Specify solenoid voltage and connectors (including built-in 50-ohm termination) by the alphabetic suffix on the switch model number and the appropriate three-digit option number.

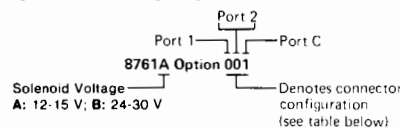

Option Code	Connector Type	Option Code	Connector Type
0	N (f)	4	APC-7 for UT-250 Coax
1	N (m)	5	SMA (f)
2	APC-7	6	SMA (m)
3	w/Threaded sleeve APC-7 w/Coupling nut	7	50Ω Termination

Ordering Information

8761A/B order must include option number

8761A/B Coaxial Switch (quantity 1-9)

8761A/B Coaxial Switch (quantity 10-24)

8761A/B Coaxial Switch with 50-ohm termination

33311B Coaxial Switch (quantity 1-9)

33311B Coaxial Switch (quantity 10-24)

33311B-C04 Coaxial Switch (quantity 1-9)

33311B-C05 Coaxial Switch (quantity 1-9)

33311C Coaxial Switch (quantity 1-9)

33311C Coaxial Switch (quantity 10-24)

POWER METERS

Power and Noise Measurements

Average Power Measurements

At microwave frequencies, power is the best measure of signal amplitude because, unlike voltage and current, power remains constant along a lossless transmission line. For this reason, power meters are almost indispensable for microwave measurements. Typical applications include monitoring transmitter power levels, calibrating signal generators, leveling signal sources, and measuring transmission characteristics of unknown devices.

To satisfy the requirements of this broad range of applications Hewlett-Packard has developed a family of general purpose microwave power meters and power sensors. The power sensors use a diode, thermocouple, or thermistor as the power sensing element, and it is important to understand the merits of each of these sensors before choosing a particular power meter.

Power Meters and Sensors

Hewlett-Packard makes six average-reading power meters. The 438A is a dual channel power meter designed for ATE systems applications. The 435B and the 436A are analog and digital meters, which are designed to operate with HP's line of thermocouple and diode power sensors. The 432 power meters are designed to operate with HP's line of thermistor mounts: the 432A is an analog power meter, the 432B is digital with BCD output, and the 432C is like the 432B but is fully programmable and auto-ranging.

Thermocouple power sensors are generally preferred for measuring power because they exhibit lower SWR and wider dynamic range than previously used thermistor elements. Low SWR is directly responsible for superior accuracy since mismatch errors are lower.

HP thermocouple sensors (8481, 8482, 8483, 8485A) are available from 100 kHz to 26.5 GHz and range from -30 dBm to +44 dBm. The model 8484A diode sensor operates with the same meters and extends the input level down to -70 dBm. This sensor uses a Low-Barrier Schottky Diode to achieve exceptional 100 pW (-70 dBm) sensitivity and low noise and drift. Because the diode is always operated in its square law region (voltage out \propto power in), the 8484A can be used to measure the true power of complex as well as CW waveforms.

Thermistor power sensors (478A, 486A series) operate with the 432A, 432B and 432C power meters. Since these power meters are based on balanced bridge principles, they are used whenever a direct dc-substitution technique is required. In addition, waveguide thermistor mounts are available from 8.20 to 40 GHz.

Peak Power Measurements

A frequent requirement in microwave work is the measurement of peak power in a periodic pulse. Rather than calculate peak power from an average power measurement, it would be more convenient to measure peak power directly. Hewlett-Packard produces two versatile instruments that accurately and conveniently measure peak power from 50 MHz to 18 GHz, and from 0 dBm to +20

dBm on pulses with widths from 100 nanoseconds to CW.

The 8900C is an economical analog power meter calibrated in watts and dBm. The 8900D has an easy to read 3 1/2 digit display calibrated in watts. Both of these peak power meters work with the 84811A peak power sensor that conveniently detaches from the meters for storage, recalibration, or replacement.

The 8900C/D meters feature two modes of operation, Direct and Compare. In the Direct mode, the meter automatically measures and displays the maximum RF power.

In the compare mode, an oscilloscope and a meter front panel control are used to measure power at arbitrary points on the pulsed waveform. In this mode, the detected pulse train and an accurate reference line, supplied by the 8900C/D, can be simultaneously displayed on the oscilloscope CRT. The front panel control moves the reference line up or down with respect to the detected waveform. The user can then measure power at any desired point on the waveform by simply moving the reference line to that point.

Automatic Systems to Calibrate Power Sensors and Attenuators

Power sensors and attenuators, in most cases, are the standards against which signal levels are compared. For this reason, it is essential that they be periodically recalibrated to maintain measurement integrity. Power sensors and attenuators are calibrated by either a highly accurate and fast, but expensive automatic network analyzer or by an economical, manual, but slow and tedious system. There is very little calibration capability offered in between. But now, HP offers an automatic power sensor and attenuator calibration system, the 436A-E40. The heart of this system is a power meter based reflectometer controlled by the HP 85F

computer. Calibration systems similar to the 436A-E40 have been in use for several years at key Hewlett-Packard calibration laboratories throughout the world.

Figure 1 shows the system configuration. In operation, for power meter calibration, test signals are standardized against a specially calibrated power sensor standard. The sensor to be calibrated is compared against the standardized signals and a calibration chart is plotted.

The system is also ideal for attenuation calibration. The accuracy and linearity of power meters plus the low SWR of power sensors offer attenuation accuracy surpassed only by error correcting automatic network analyzers.

The reports for Cal-Factor and attenuation are printed in either tabular or graph form and they include the calibration uncertainty. Coaxial power sensors and attenuators can be calibrated from 100 MHz to 26.5 GHz in 3 bands, 100 MHz to 2 GHz, 2 to 18 GHz, and 18 to 26.5 GHz. Waveguide thermistor sensors can be calibrated in X, P, and K bands.

Literature

Application Note 64-1, **Fundamentals of RF and Microwave Power Measurements**, deals with the general theory of microwave power measurements. It covers the basic principals of measurement, calculation of measurement uncertainty, traceability, etc.

Application Note 64-2, **Extended Applications of Automatic Power Meters**, discusses an automatic power meter system for measuring attenuation gain saturation and the calibration factor of power sensors.

Application Note 196, **Automated Measurements using the 436A Power Meter**, contains several typical uses of the 436A with the HP-IB interface bus. All of these applications notes and a coaxial and waveguide catalog are available without charge. See page 659.

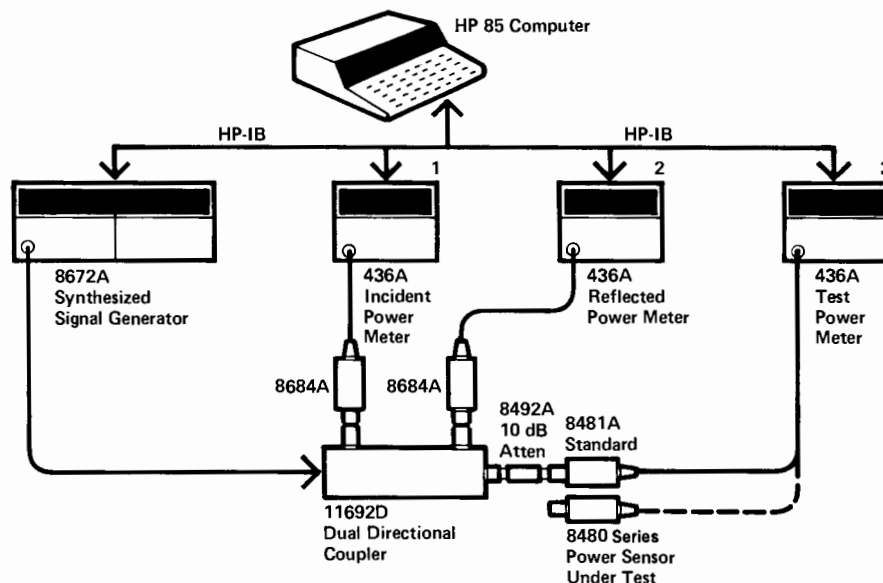

Figure 1. Power sensors and attenuators calibration system.



- Ideal for ATE applications
- Dual power sensors
- Innovative ratio & difference measurements



The HP Model 438A Power Meter is a dual channel power meter designed specifically for ATE systems. The compact front panel is designed to save space in rack mounted systems, while the dual channel design allows simple measurements of the ratio and difference of power levels from two separate sensors. Compatible with the 8480 series of thermocouple and diode sensors, the power and frequency range of the meter extends from -70 dBm to 44dBm and from 100 kHz to 26.5 GHz.

Important measurement contributions are a programmable digital filter for optimizing resolution and measurement speed, independent offset (in dB) values for each channel, 0.001 dB resolution available, and a power difference mode for displaying absorbed power in transmission lines. Up to 19 different operating states of the meter can be stored into non-volatile memory for later recall.

The Hewlett-Packard Interface Bus (HP-IB) capability is standard on the 438A with programming codes printed on the front panel for easy reference. All measurement modes are programmable including zeroing, calibration, and Cal Factor. Complete interrupt capability with flexible SRQ operation optimizes the efficiency of program execution in automatic systems.

438A Specifications

Frequency range: 100 kHz to 26.5 GHz (depending on power sensor used)

Power range: -70 dBm to $+44$ dBm (100 pW to 25 W), sensor dependent. Uses 8480 series power sensors, see sensor specs for details.

Operating temperature range: 0 – 55°C

Accuracy

Instrumentation

Single channel, linear mode: $\pm 0.5\%$

log mode: ± 0.02 dB

Dual channel, linear mode: $\pm 0.10\%$

log mode: ± 0.04 dB

Zeroing: automatic, $\pm 0.5\%$ full scale on most sensitive range.

Power Reference

Power output: 1.00 mW. Factory set to $\pm 0.7\%$, traceable to the U.S. National Bureau of Standards.

Accuracy: $\pm 1.2\%$ worst case ($\pm 0.9\%$ rss) for 1 year.

Connector: front panel type N female (also on rear panel, Opt 002).

Meter Adjustments

Cal factor: values from 1% to 150% in 0.1% steps can be entered to account for sensor frequency response. Sensor calibration: automatic self calibration to 1.00 mW

General

Display: four digit display (five digits in high resolution mode) with

20% over-range capability on all ranges. Annunciators to indicate measurement mode, Cal Factor, offset value, fixed or automatic range and filter values, and error conditions.

Recorder output: linearly proportional to power in watts. One volt corresponds to full scale; 1K Ω output impedance, BNC rear panel female connector.

Line voltage: 100, 120, 220 or 240 Vac $+5\%$ – 10% . 100 and 120 volts, 48 to 66 Hz and 300 to 440 Hz. 220 and 240 volts, 48 to 66 Hz only.

Power requirements: 65 VA, 35 Watts, maximum.

Weight: net, 5.9 kg (13 lb). Shipping, 9.1 kg (20 lb).

Dimensions: 89 mmH x 213 mmW x 418 mmD (3.5 x 8.4 x 16.8 in)

HP-IB interface codes: SH1, AH1, T5, TE0, L4, LE0, SR1, RL1, PP1, DC1, DT1, C0

Accessories Furnished

11730A, 2 each, 1.5 meter (5 ft) power sensor cables. Power cable, 1 each, 2.4 meters (7.5 ft). Mains plug matches destination requirements.

Accessories & Options Available

To select non-standard lengths for power sensor cables, select option 004 (delete sensor cables) and order as required from 11730A-F, power sensor cables. Lengths are available from 1.5 meters (5 ft) to 61 meters (200 ft).

438A Dual Channel Power Meter

Option 002: Rear panel sensor connectors (in parallel with front panel) and additional reference oscillator with rear panel output.

Option 004: Delete power sensor cables

Option 910: Additional manual

11730A-F Power Sensor Cables

The 11730 series power sensor cables are for use with the 435B, 436A, and 438A power meters and the 8480 series thermocouple and diode power sensors. These cables are designed to reduce RFI effects on low power readings with an improved shielding design in the cable itself. Cables may be ordered individually or in pairs in any combination desired for single and dual channel measurements.

The 11730A cable is the standard cable for the 435B, 436A, and 438A (2 cables shipped) meters. To order a non-standard cable, select Option 004 for the meter in question, and order the desired cable from below.

Ordering Information

11730A 1.5 meter (5 ft) sensor cable

11730B 3.0 meter (10 ft) sensor cable

11730C 6.1 meter (20 ft) sensor cable

11730D 15.2 meter (50 ft) sensor cable

11730E 30.5 meter (100 ft) sensor cable

11730F 61.0 meter (200 ft) sensor cable



POWER METERS

Thermocouple Power Meter

Model 436A

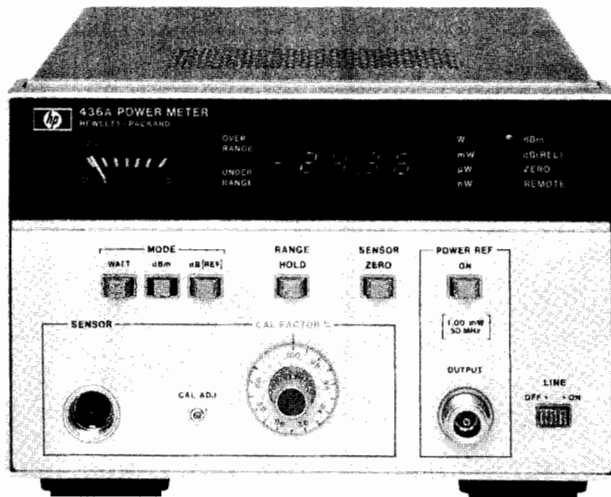

436A



436A Power Meter

The HP Model 436A Power Meter is a general purpose digital power meter intended for manual and automatic RF and microwave power measurements. It is compatible with the entire series of 8480 power sensors. Depending on which power sensor is used, the 436A can measure power from -70 dBm (100 pW) to $+44$ dBm (25 W) at frequencies up to 26.5 GHz.

The logically organized and uncluttered front panel, and the convenience of push-button operation and digital display make the 436A both easy to interpret and easy to use in any application. The auto ranging capability allows for "hands-off" operation.

The 436A measures either absolute or relative power. It displays absolute power in either watts or dBm, and relative power in dB.

The 436A Power Meter also features optional programmability; both Hewlett-Packard Interface Bus (HP-IB) and BCD interfaces are available. These interfaces allow full remote control of all power meter functions (CAL function can be programmed to either 100 percent or the CAL factor which has been manually set on the front panel). These options may be added by the user at a later time.

436A Specifications

Frequency range: 100 kHz to 26.5 GHz (depending on power sensor used).

Temperature range: 0–55°C

Power Range (display calibrated in watts, dBm, and dB relative to reference power level).

With 8481A, 8482A, 8483A, 8485A sensors: 50 dB with 5 full-scale ranges of -20 , -10 , 0, 10, and 20 dBm (10 μ W to 100 mW).

With 8481B or 8482B sensors: 44 dB with 5 full-scale ranges of 10, 20, 30, 40, and 44 dBm (10 mW to 25 W).

With 8481H or 8482H sensors: 45 dB with 5 full-scale range of 0, 10, 20, 30 and 35 dBm (1 mW to 3 W).

With 8484A sensor: 50 dB with 5 full-scale ranges of -60 , -50 , -40 , -30 , and -20 dBm (1 nW to 10 μ W).

Accuracy

Instrumentation

Watt mode: $\pm 0.5\%$.

dBm mode: ± 0.02 dB ± 0.001 dB/°C.

dB (REL) mode¹: ± 0.02 dB ± 0.001 dB/°C.

¹ Specifications are for within range measurements. For range-to-range accuracy add another ± 0.02 dB.

Zero: automatic, operated by a front-panel switch.

Zero set: $\pm 0.5\%$ of full scale on most sensitive range, typical; ± 1 count on other ranges.

Zero carry over: $\pm 0.2\%$ of full scale when zeroed on the most sensitive range.

Power reference: internal 50 MHz oscillator with Type N female connector on front panel (or rear panel, Option 003 only).

Power output: 1.0 mW. Factory set to $\pm 0.7\%$ traceable to the National Bureau of Standards.

Accuracy: $\pm 1.2\%$ worst case ($\pm 0.9\%$ rss) for one year.

Supplemental Characteristics

Noise (typical, at constant temperature, peak change over any one-minute interval): 20 pW (8484A); 40 nW (8481A, 8482A, 8483A, 8485A); 40 μ W (8481B, 8482B); 4 μ W (8481H, 8482H).

Drift (1 hour, typical, at constant temperature after 24-hour warm-up): 20 pW (8484A); 10 nW (8481A, 8482A, 8483A, 8485A); 10 μ W (8481B, 8482B); 1 μ W (8481H, 8482H).

Response time typical, measured at recorder output, 0 to 99% of reading:

Range 1 (most sensitive range) < 10 seconds

Range 2 < 1 second

Ranges 3 through 5 < 100 milliseconds

Cal factor: 16-position switch normalizes meter reading to account for calibration factor. Range 85% to 100% in 1% steps.

Cal adj: front-panel adjustment provides capability to adjust gain in meter to match power sensor in use.

Recorder output: linearly proportional to indicated power with 1 volt corresponding to full scale and 0.316 volts to -5 dB; 1 k Ω output impedance, BNC connector.

RF blanking: open collector TTL; pulls low during meter zeroing. Useful for turning off RF input to sensor during auto-zeroing. BNC connector.

Display: four-digit display with 20% over-range capability on all ranges; analog uncalibrated peaking meter to show fast changes.

Power consumption: 100, 120, 220, or 240 V (+5%, -10%), 48 to 66 Hz, and 360 to 440 Hz; < 20 V \cdot A (< 23 V \cdot A with option 022 or 024).

Weight: net, 4.5 kg (10 lb). Shipping, 5.5 kg (12 lb).

Size: 134 H x 213 W x 279 mm D (5.2" x 8.4" x 11.0").

Accessories

Furnished: 1.5 m (5 ft) cable for power sensor; 2.3 m (7.5 ft) power cable. Mains plug shipped to match destination requirements.

Available: to rack mount one 436A by itself, order 5061-0057 Rack Mount Adapter Kit.

Ordering Information

436A Power Meter

Option 002: Input connector on rear panel in parallel with front

Option 003: Parallel sensor inputs front and rear panel, reference oscillator output on rear panel only.

Option 004: Delete power sensor cable

Option 022: Digital input/output, fully compatible with HP Interface Bus (HP-IB)

Option 024: Digital input/output BCD Interface

Option 908: Kit for rack mounting one 436A

Option 910: Extra operating and service manual

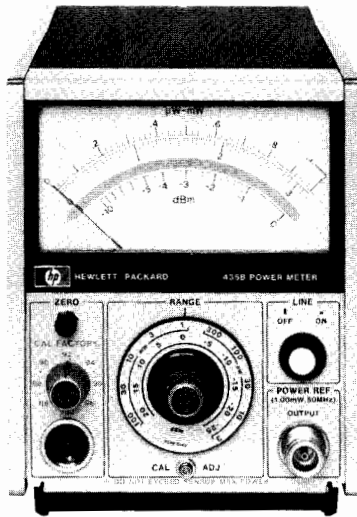

435B

435B Power Meter

The 435B Power Meter is an analog power meter, compatible with the entire series of 8480 power sensors. Depending on which sensor is used, the 435B can measure power from -65 dBm to $+44$ dBm, full scale, at frequencies from 100 kHz to 26.5 GHz. This versatile instrument also features $<1\%$ instrumentation uncertainty, low noise and drift, auto-zero, recorder output, optional battery operation, and long cable options up to 61 m (200 ft).

11683A Range Calibrator

The 11683A calibrator is specifically designed for use with the 435B and 436A power meters. It allows verification of full-scale meter readings on all ranges, as well as meter tracking. Simply connect the cable between the power meter and calibrator. The CAL ADJ control on the power meter is used to set the meter to full scale on the 1 mW range. The calibrator and meter are then stepped through the other ranges verifying accuracy within $\pm 1\%$ plus noise and drift. The 11683A also has a polarity switch which tests the Auto-Zero circuit.

435B Specifications

Frequency range: 100 kHz to 26.5 GHz (depending on power sensor used).

Temperature range: 0 -55°C

Power Range (calibrated in watts and dB in 5 dB steps).

With 8481A, 8482A, 8483A or 8485A: -25 dBm ($3 \mu\text{W}$) to $+20$ dBm (100 mW) full scale.

With 8481B or 8482B: $+5$ dBm (3 mW) to $+44$ dBm (25 W) full scale.

With 8481H or 8482H: -5 dBm (0.3 mW) to $+35$ dBm (3 W) full scale.

With 8484A: -65 dBm (300 pW) to -20 dBm ($10 \mu\text{W}$) full scale.

Accuracy

Instrumentation: $\pm 1\%$ of full scale on all ranges.

Zero: automatic, operated by front-panel switch.

Zero set: $\pm 0.5\%$ of full scale on most sensitive range, typical.

Zero carryover: $\pm 0.5\%$ of full scale when zeroed on the most sensitive range.

Power reference: internal 50 MHz oscillator with Type N female connector on front panel (or rear panel, Option 003 only).

Power output: 1.00 mW. Factory set to $\pm 0.7\%$ traceable to the National Bureau of Standards.

Accuracy: $\pm 1.2\%$ worst case ($\pm 0.9\%$ rss) for one year.

Supplemental Characteristics

Noise (typical, at constant temperature, peak change over any one-minute interval): 20 pW (8484A); 40 nW (8481A, 8482A, 8483A, 8485A); 40 μW (8481B, 8482B); 4 μW (8481H, 8482H).

Drift (1 hour, typical, at constant temperature after 24-hour warm-up): 40 pW (8484A); 15 nW (8481A, 8482A, 8483A, 8485A); 15 μW (8481B, 8482B); 1.5 μW (8481H, 8482H).



11683A

Response Time (typical, measured at recorder output, 0 to 99% of reading)

Range 1 (most sensitive range) <10.0 seconds

Range 2 <3.8 seconds

Range 3 <1.3 seconds

Ranges 4 to 10 <500 milliseconds

Cal factor: 16-position switch normalizes meter reading to account for calibration factor; range 85% to 100% in 1% steps.

Recorder output: linearly proportional to indicated power with 1 volt corresponding to full scale: 1 k Ω output impedance, BNC connector.

RF blanking output: provides a contact closure to ground. Used for turning off RF input to sensor during auto-zeroing. BNC connector.

Cal adj: front-panel adjustment provides capability to adjust gain of meter to match power sensor in use.

Power consumption: 110 or 120 V ($+5\%$, -10%), 48 to 66 Hz and 360 to 440 Hz; also 220 or 240 V ($+5\%$, -10%), 48 to 66 Hz only: $<20\text{V} \cdot \text{A}$.

Weight: net, 2.7 kg (5.9 lb). Shipping, 4.2 kg (9.2 lb).

Size: 155 H x 130 W x 279 mm D (6.3" x 5.1" x 11").

Accessories

Furnished: 1.52 m (5 ft) cable for the power sensor; 2.3 m (7.5 ft) power cable, (mains plug shipped to match destination requirements).

Available (see page 663)

11076A: Carrying case.

5060-8762: Rack adapter frame (holds three instruments the size of the 435B).

Combining Cases (see page 662).

1051A: 286 mm (11.25 in.) deep.

1052A: 416 mm (16.4 in.) deep.

These combining cases accept $\frac{1}{2}$ -module Hewlett-Packard instruments for bench use or rack mounting.

11683A Range Calibrator

Calibration functions: outputs corresponding to meter readings of 3, 10, 30, 100 and 300 μW ; 1, 3, 10, 30, and 100 mW.

Calibration uncertainty: $\pm 0.25\%$ in all ranges.

Power: 100, 120, 220, or 240 Vac $+5\%$, -10% , 48-440 Hz, less than 10 VA.

Weight: net, 1.13-kg (2.5 lb). Shipping, 1.9 kg (4.2 lb).

Size: 89 H x 133 W x 216 mm D (3.5" x 5.25" x 8.5").

Ordering Information

11683A Range Calibrator

435B Power Meter

435B Options

001: Rechargeable battery installed provides up to 16 hours of continuous operation

002: Input connector placed on rear panel in parallel with front

003: Parallel sensor inputs front and rear panels, reference oscillator output on rear panel.

004: Delete power sensor cable

910: Extra operating and service manual



Power Sensors

Models 8481A/B, 8481H, 8482A/B, 8482H, 8483A, 8484A, 8485A, 11708A

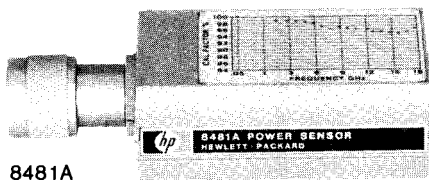

8481A

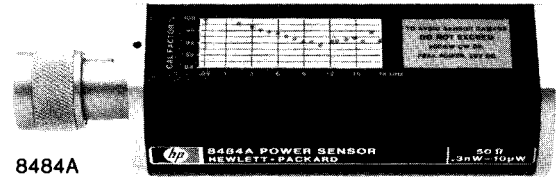

8484A

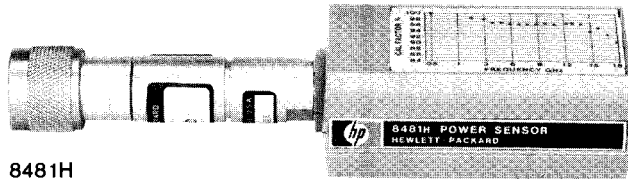

8481H

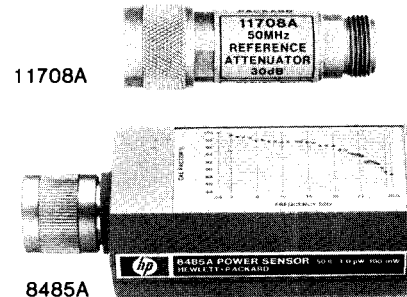

11708A

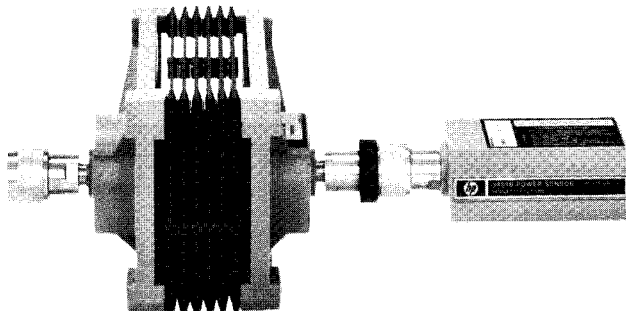

8481B

8480 Series Power Sensors

The 8480 series of power sensors have been designed for use with the 435B and 436A Power Meters. They feature wide frequency and power ranges in addition to very low SWR.

The power measurement range of these sensors is from 0.1 nW to 25 Watts. With just three sensors a power measurement range of 114 dB can be achieved.

Wide Frequency Range for Many Applications

Power measurements can be made over a frequency range of 100 kHz to 26.5 GHz. The four frequency ranges covered with these units are 10 MHz to 18 GHz, 100 kHz to 4.2 GHz, and 50 MHz to 26.5 GHz, in 50 Ω sensors and 100 kHz to 2 GHz, with the 75-ohm sensor.

Low SWR for Low Measurement Uncertainty

The 8481/82/83/85 series of sensors use a silicon monolithic thermocouple as the sensing element. The small physical size of the thermocouple enables the sensors to have a very low SWR even at 26.5 GHz. A low SWR reduces mismatch uncertainty error, typically the largest single source of error in power measurements. The 8484A sensor uses a crystal detector for higher sensitivity and low SWR.

Individually Calibrated for More Confidence in Results

Each sensor is individually calibrated, traceable to the National Bureau of Standards. A control on the meter compensates for power sensor Cal Factor at any frequency. A precise Automatic Network Analyzer printout for Cal Factor and reflection coefficient in magnitude and phase is supplied with the 8481A/B/H, 8484A, and 8485A. This means you can significantly reduce mismatch uncertainty by calculating the mismatch error.

High Power Sensors to 25 Watts

The new 8481B and 8482B high power sensors both have a power range of 1 mW to 25 watts. The 8481B covers a frequency range of 10 MHz to 18 GHz and the 8482B has a frequency range of 100 kHz to 4.2 GHz.

Previous methods of measuring high power levels usually required adding a separate attenuator in front of a low power sensor. With the 8481/82B power sensors, the attenuator and sensor are combined into one unit. This reduces mismatch uncertainty error and improves accuracy by including the attenuator in the measured Calibration Factor curves. In addition, light-weight, heat-dissipating fins on the attenuator prevent burns.

Medium Power Sensors to 3 Watts

Model 8481H measures power from 100 μ W to 3 watts over a frequency range of 10 MHz to 18 GHz. The 8482H measures power from 30 μ W to 3 watts over a frequency range of 100 kHz to 4.2 GHz.

Standard Sensors to 100 mW

The 8481A, 8482A, 8483A, and 8485A power sensors all measure power over a range of 1 μ W to 100 mW. The 8481A is a 50-ohm sensor with a frequency range of 10 MHz to 18 GHz. The 8482A is a 50-ohm sensor with a frequency range of 100 kHz to 4.2 GHz. The 8485A is a 50-ohm sensor with a frequency range of 50 MHz to 26.5 GHz. The 8483A is a 75-ohm sensor and covers a frequency range of 100 kHz to 2 GHz.

High Sensitivity Sensors

The 8484A measures power from 0.1 nW to 10 μ W over a frequency range of 10 MHz to 18 GHz. It is furnished with the 11708A 50 MHz Reference Attenuator for precise calibration with 1 mW Power Meter Reference Oscillator. Noise and drift have been reduced to less than 5% of full scale on the 300 pW range (only 15 pW) when it is used with the 435B Power Meter. Noise and drift are even less with the 436A Power Meter.

Broadband Power Sensor

The 8485A thermocouple power sensor covers a frequency range of 50 MHz to 26.5 GHz and a power range of -30 dBm to +20 dBm (1 μ W to 100 mW). Low SWR (<1.25 at 26.5 GHz) reduces mismatch uncertainty which increases power measurement accuracy. The ruggedized APC-3.5 input connector is SMA compatible and repeatable. The actual Cal Factor is plotted on each 8485A label at 34 frequencies. Each unit is shipped with a print-out which lists Cal Factor and the actual reflection coefficient in magnitude and phase.



8480 Series Specifications

Model	Nominal Impedance	Frequency Range	Power Range	Maximum Power	Power Linearity*	Maximum SWR (Reflection Coefficient)	Size mm (in.)	Shipping Weight kg (lb)	RF Connector
8481A	50 Ω	10 MHz-18 GHz	1 μW to 100 mW	300 mW avg. 15 W peak 30 W • μs (per pulse)	+10 to +20 dBm +2, -4%	10 MHz - 30 MHz: 1.40 (0.166) 30 MHz - 50 MHz: 1.18 (0.083) 50 MHz - 2 GHz: 1.10 (0.048) 2 - 12.4 GHz: 1.18 (0.083) 12.4 - 18 GHz: 1.28 (0.123)	30 x 38 x 105 (1.2 x 1.5 x 4.1)	0.5 (1)	N(m)
Option 001									APC-7
8481B	50 Ω	10 MHz-18 GHz	0-35°C, 1 mW-25W; 35°C-55°C, 1 mW-20 W	0-35°C: 30 W avg. ¹ 35°C-55°C: 25 W avg. 10 MHz-5.8 GHz 500 W peak 5.8-18 GHz 125 W peak 500 W • μs (per pulse)	+35 to +44 dBm ±4%	10 MHz - 2 GHz: 1.10 (0.048) 2-12.4 GHz: 1.18 (0.083) 12.4-18 GHz: 1.28 (0.123)	83 x 114 x 248 (3.25 x 4.5 x 9.75)	1.5 (3.2)	N(m)
8481H	50 Ω	10 MHz-18 GHz	100 μW to 3W	3.5 W avg. 100 W peak 100 W • μs (per pulse)	+25 to +35 dBm ±5%	10 MHz - 8 GHz: 1.20 (0.091) 8-12.4 GHz: 1.25 (0.110) 12.4 - 18 GHz: 1.30 (0.130)	30 x 38 x 149 (1.2 x 1.5 x 5.9)	0.5 (1)	N(m)
8482A	50 Ω	100 kHz-4.2 GHz	1.0 μW to 100 mW	300 mW avg. 15 W peak 30 W • μs (per pulse)	+10 to +20 dBm +2, -4%	100-300 kHz: 1.60 (0.231) 300 kHz - 1 MHz: 1.20 (0.091) 1 MHz - 2 GHz: 1.10 (0.048) 2-4.2 GHz: 1.30 (0.130)	30 x 38 x 105 (1.2 x 1.5 x 4.1)	0.5 (1)	N(m)
8482B	50 Ω	100 kHz-4.2 GHz	0-35°C, 1 mW-25 W; 35°C-55°C, 1 mW-20 W	0-35°C: 30 W avg. ¹ 35°C-55°C: 25 W avg. 500 W peak 500 W • μs (per pulse)	+35 to +44 dBm ±4%	100 kHz - 2 GHz: 1.10 (0.048) 2 GHz - 4.2 GHz: 1.18 (0.083)	83 x 114 x 248 (3.2 x 4.5 x 9.7)	1.5 (3.2)	N(m)
8482H	50 Ω	100 kHz-4.2 GHz	100 μW to 3W	3.5 W avg. 100 W peak 100 W • μs (per pulse)	+25 to +35 dBm ±5%	100 kHz-4.2 GHz: 1.20 (0.091)	30 x 38 x 149 (1.2 x 1.5 x 5.9)	0.5 (1)	N(m)
8483A	75 Ω	100 kHz-2 GHz	1.0 μW to 100 mW	300 mW avg. 10 W peak 30 W • μs (per pulse)	+10 to +20 dBm +2, -4%	100-600 kHz: 1.80 (0.286) 600 kHz - 2 GHz: 1.18 (0.083)	30 x 38 x 105 (1.2 x 1.5 x 4.1)	0.5 (1)	N(m) 75 Ω
8484A ⁴	50 Ω	10 MHz-18 GHz	0.1 nW to 10 μW	200 mW avg. 200 mW peak	-30 to -20 dBm ±1%	10-30 MHz: 1.40 (0.166) 30 MHz - 4 GHz: 1.15 (0.070) 4-10 GHz: 1.20 (0.091) 10-15 GHz: 1.30 (0.130) 15-18 GHz: 1.35 (0.149)	36 x 44 x 133 (1.4 x 1.7 x 5.2)	0.5 (1)	N(m) ³
8485A	50 Ω	50 MHz-26.5 GHz	1 μW to 100 mW	300 mW avg. 15 W peak 30 W • μs (per pulse)	+10 to +20 dBm +2, -4%	50 MHz-100 MHz: 1.15 100 MHz-2 GHz: 1.10 2-12.4 GHz: 1.15 12.4-18 GHz: 1.20 18-26.5 GHz: 1.25	30 x 38 x 95 (1.2 x 1.5 x 3.7)	0.5 (1)	APC3.5(m)

¹For pulses greater than 30 W the maximum average power (Pa) is limited by the energy per pulse (E) in W • μs according to Pa = 30-0.02E.

²Negligible deviation except for those power ranges noted.

³Includes 1250-0597 adapter from 75 Ω type N to 50 Ω type N for calibration.

⁴The 11708A 30 dB attenuator for calibrating against a 0 dBm, 50 MHz power reference is shipped with the 8484A.

Uncertainty of Calibration Factor Data for 8482A and 8483A

Frequency (MHz)	Sum of Uncertainties (%) ¹				Probable Uncertainties (%) ²			
	8482A	8482B	8482H	8483A	8482A	8482B	8482H	8483A
0.1	±2.3	±5.7	±3.3	±2.6	±1.3	±2.8	±1.6	±1.5
0.3	2.2	5.7	3.2	2.5	1.2	2.8	1.6	1.4
1.0	2.2	5.7	3.2	2.5	1.2	2.8	1.6	1.4
3.0	2.2	5.7	3.2	2.5	1.2	2.8	1.6	1.4
10.0	2.5	5.7	3.5	3.0	1.3	2.8	1.6	1.6
30.0	2.6	5.7	3.6	3.1	1.4	2.8	1.7	1.6
50.0	0(ref)	2.7	0(ref)	0(ref)	0(ref)	2.7	0(ref)	0(ref)
100.0	3.1	5.6	4.1	3.9	1.6	3.3	1.9	2.0
300.0	3.1	5.6	4.1	3.9	1.6	3.3	1.9	2.0
1000.0	2.7	5.7	3.7	3.7	1.4	3.3	1.7	2.0
2000.0	2.7	5.5	3.7	3.9	1.4	3.1	1.7	2.1
4000.0	2.8	5.5	3.8	—	1.5	3.1	1.8	—

Uncertainty of Calibration Factor Data for 8481A/B, 8484A and 8485A

Frequency (GHz)	Sum of Uncertainties (%) ¹					Probable Uncertainties (%) ²				
	8481A	8481B	8481H	8484A	8485A	8481A	8481B	8481H	8484A	8485A
0.1	±3.1	±6.4	±4.1	±4.4	—	±1.6	±3.0	±1.9	±1.9	—
2	2.7	5.8	3.7	4.0	±3.6	1.4	3.1	1.7	1.8	±2.1
4	2.8	5.8	3.8	4.1	—	1.5	3.1	1.8	1.8	—
6	2.8	5.8	3.8	4.1	4.0	1.5	3.1	1.8	1.8	2.3
8	3.2	6.0	4.2	4.6	—	1.7	3.2	2.0	2.0	—
10	3.6	6.2	4.6	5.1	4.7	1.9	3.3	2.2	2.2	2.7
12	3.9	7.8	4.9	6.5	—	2.1	4.1	2.4	2.8	—
14	4.8	7.9	5.8	7.4	5.6	2.6	4.1	2.8	3.2	3.2
16	5.2	8.0	6.2	7.8	—	2.9	4.2	3.0	3.4	—
18	5.8	8.3	6.8	8.4	5.9	3.2	4.3	3.4	3.7	3.6
22	—	—	—	—	6.8	—	—	—	—	3.7
26.5	—	—	—	—	7.3	—	—	—	—	4.0

¹Includes uncertainty of reference standard and transfer uncertainty. Directly traceable to NBS.

²Square root of sum of the individual uncertainties squared (RSS).

- Automatic zero
- High accuracy

- Recorder outputs, analog & digital
- Long cable options

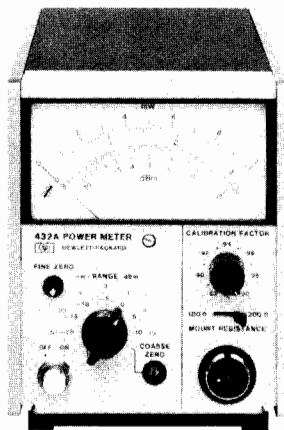

432A

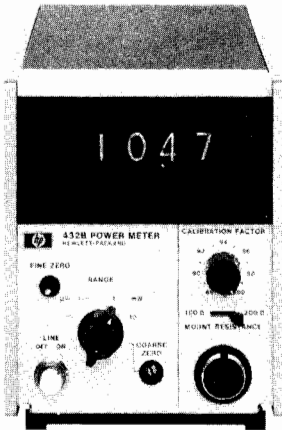

432B

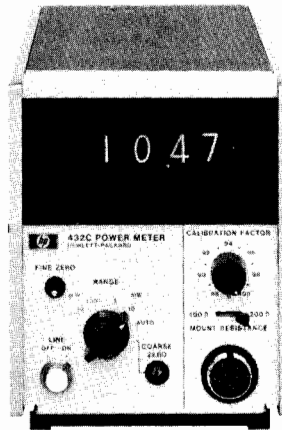

432C

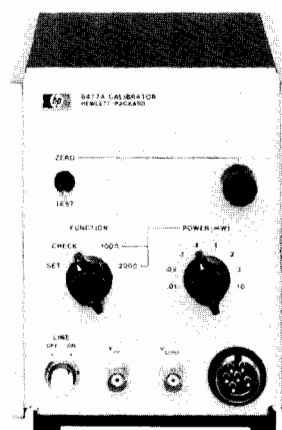

8477A

432A/B/C Power Meters

High accuracy—no thermoelectric error: high accuracy over a wide temperature range is featured on the 432 Power Meters. By measuring the output voltage of the thermistor bridges, and computing the corresponding power, even higher accuracy of $\pm 0.2\% \pm 0.5 \mu\text{W}$ can be obtained.

Accuracy can be maintained on even the most sensitive range because the error due to thermoelectric effect is reduced to a negligible level.

Calibrated mounts: each thermistor mount is furnished with data stating the Calibration Factor* and Effective Efficiency* at various frequencies across the operating range. For easy and accurate power measurements, the front panel of the 432 contains a calibration factor control, calibrated in 1% steps from 88% to 100%, that compensates for losses in the mount and eliminates the need for calculation.

Instrument type: automatic, self-balancing power meter for use with temperature-compensated thermistor sensor.

*"Calibration Factor" and "Effective Efficiency" are figures of merit expressing the ratio of the substituted signal measured by the power meter to the microwave power incident on and absorbed by the sensor.

Specifications (partial)

Power Range

432A: seven ranges with full-scale readings of 10, 30, 100, and 300 μW , 1, 3, and 10 mW; also calibrated in dBm from -20 dBm to $+10$ dBm full scale in 5 dB steps.

432B, 432C: four ranges with full-scale readings of 10 and 100 μW , and 1 and 10 mW.

Noise: less than 0.25% of full scale peak (typical).

Response time: at recorder output, 35 ms time constant (typical).

Fine zero: automatic, operated by front panel switch. Remote fine zero may be accomplished with 432C.

Zero carryover: less than 0.50% of full scale when zeroed on most sensitive range.

Meter

432A: taut-band suspension, individually calibrated, mirror-backed scales. Milliwatt scale more than 108 mm (4.25 in.) long.

432B, 432C: three digits with one digit overrange. 20% overrange capability on all ranges.

Calibration factor control: 13-position switch normalizes meter reading to account for thermistor sensor calibration factor. Range 100% to 88% in 1% steps.

Thermistor sensor: thermistor sensors are required for operation of the 432A/B/C. For microwave sensors HP 478B, 8478B and 486 series see page 419.

Recorder output: proportional to indicated power with 1 volt corresponding to full-scale. 1 k Ω output impedance.

BCD output: 8, 4, 2, 1 code: "1" positive. TTL compatible logic. Operates with HP 5150A, Opt 002 (BCD) Digital Recorder. "Print" and "Inhibit" lines available. (432B and 432C only.)

Model 432C control lines: instrument is referenced to +5 V, "Logic 0" is equivalent to 0 V.

Power Consumption

432A: 115 or 230 V ac $\pm 10\%$, 50 to 400 Hz, 1.5 watts.

432B: 115 or 230 V ac $\pm 10\%$, 50 to 400 Hz, 10 watts.

432C: 115 or 230 V ac $\pm 10\%$, 50 to 400 Hz, 16 watts.

Weight

432A: net, 2.3 kg (5.5 lb). Shipping, 4.6 kg (10 lb).

432B: net, 3 kg (6.5 lb). Shipping, 4.8 kg (10.5 lb).

432C: net, 3.2 kg (7.2 lb). Shipping, 5 kg (11 lb).

Size: 130 W x 155 H x 279 mm D (5.2" x 6.1" x 11.0").

8477A Power Meter Calibrator

The 8477A Calibrator is specifically designed for use with the 432 Power Meter. It allows you to verify full-scale meter readings on all ranges, and meter tracking. Simply connect three cables between the power meter and calibrator; no charts or additional instruments are required.

Power: 115 or 230 Vac $\pm 10\%$, 50 to 400 Hz, 3 watts.

Ordering Information

432A Power meter

432B Power meter

432C Power meter

432A/B/C Options

001: rechargeable battery installed, provides up to 20 hours continuous operation (432A only)

002: input connector placed on rear panel in parallel with front

003: input connector on rear panel only

009: 3.1 m (10 ft) cable for 110-ohm or 200-ohm sensor

010: 6.1 m (20 ft) cable for 100-ohm or 200-ohm sensor

011: 15.2 m (50 ft) cable for 100-ohm or 200-ohm sensor

012: 30.5 m (100 ft) cable for 100-ohm or 200-ohm sensor

013: 61 m (200 ft) cable for 100-ohm or 200-ohm sensor

100: 100 Vac operation, 48–66 Hz

910: extra operating and service manual

8477A Power Meter Calibrator

Thermistor Mounts, Peak Power Sensor & Peak Power Meters Models 478A, 8478B, 486 Series, 8900C/D, 84811A

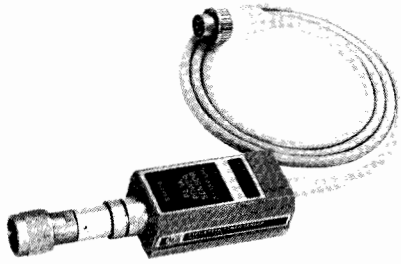

84811A



478A



8478B

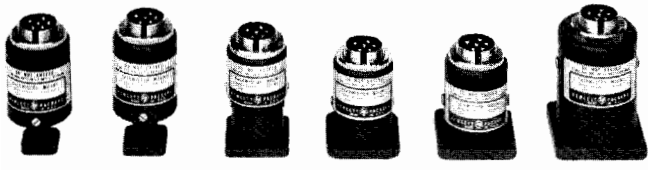

486 Series

Temperature Compensated Thermistor Mounts

High efficiency and good RF match are characteristic of the HP 478A and 8478B Coaxial and 486A Series Waveguide Thermistor mounts. Used in conjunction with the 432 Power Meter they provide high accuracy even in routine power measurements. These thermistor mounts are temperature-compensated for low drift, even in the presence of thermal shocks, permitting measurement of microwave power as low as one microwatt. Each mount contains data showing Calibration Factor and Effective Efficiency at six frequencies, directly traceable to the National Bureau of Standards at those frequencies where NBS provides calibration service.

486, 478, 8478B Specifications

Model	Frequency range, GHz	Maximum SWR	Operating Resistance (Ohms)
478A	10 MHz to 10 GHz	1.75, 10 to 25 MHz 1.3, 25 MHz to 7 GHz 1.5, 7 to 10 GHz	200
8478B ¹	10 MHz to 18 GHz	1.75, 10 to 30 MHz 1.35, 30 to 100 MHz 1.1, 0.1 to 1 GHz 1.35, 1 to 12.4 GHz 1.6, 12.4 to 18 GHz	200
X486A	8.20 to 12.4	1.5	100
M486A	10.0 to 15.0	1.5	100
P486A	12.4 to 18.0	1.5	100
K486A ²	18.0 to 26.5	2.0	200
R486A ²	26.5 to 40.0	2.0	200

¹Option 011: furnished with APC-7 RF connector
²Circular flange adapters:
K-band (UG-425/U) HP 11515A
R-band (UG-381/U) HP 11516A

84811A Peak Power Sensor

The 84811A Peak Power Sensor works with the 8900C/D Peak Power Meters to measure the peak power of RF pulses. It is supplied with a 4 foot flexible cable to easily reach the pulses source being measured. Any sensor can be used with any meter. The 84811A also conveniently detaches from the meter for storage, recalibration or replacement.

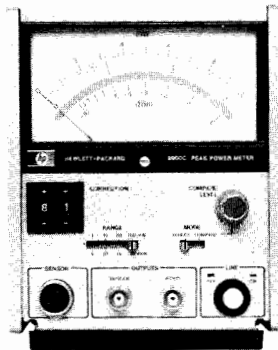

8900C



8900D

8900C/D Peak Power Meters

The 8900C and 8900D Peak Power Meters directly display the peak power of RF pulses over a 100 MHz to 18 GHz frequency range. Measurements can be made on pulses with widths from 1 μs (100 ns in Compare mode) to CW, and repetition rates from 100 Hz (0 Hz in Compare mode) to 100 kHz.

The 8900C is an economical analog meter calibrated in watts and dBm. The analog display with its large, easy to read scale makes it simple to peak or null pulsed power systems. The 8900D has a high resolution 3½ digit digital display calibrated in watts. The direct reading display and range annunciators make the digital version a good choice for production and field applications where unambiguous or frequent readings are required.

8900C/D Peak Power Meters Specifications

- Frequency range:** 100 MHz to 18 GHz.
- Dynamic range:** 20 dB (0 to +20 dBm).
- 8900C:** 4 ranges of 3, 10, 30 and 100 mW full scale.
- 8900D:** 2 ranges of 10 and 100 mW full scale.
- Pulse Response**
 - Direct Mode**
 - Pulse width:** 1 μs to CW.
 - Repetition rate:** 100 Hz to 100 kHz.
 - Compare Mode**
 - Pulse width:** 100 ns (typical) limited by rise time specification.
 - Repetition rate:** 0 to 100 kHz
 - Rise time:** 75 ns.
 - Fall time:** 125 ns (as measured on video output).
- Power consumption:** 100 and 120 Vac +5, -10%, 48-66 Hz and 360-440 Hz; 220 and 240 Vac +5, -10%, 48-66 Hz

Meter Accuracy	CW	Pulse	Transfer Accuracy CW to Pulse
Direct	±0.2 dB	±0.35 dB	±0.2 dB
Compare	±0.2 dB	±0.25 dB	±0.1 dB

84811A Peak Power Sensor Specifications

- Power range:** 0 to +20 dBm (1 mW to 100 mW).
- Frequency range:** 100 MHz to 18 GHz.
- SWR:** 100 MHz to 12 GHz < 1.5. 12 GHz to 18 GHz < 2.0.
- Maximum peak power:** +24 dBm (250 mW) for 5 minutes.
- Connector type:** N (male).
- Calibration:** every 2 GHz from 2 to 10 GHz. Every 1 GHz from 11 to 18 GHz.
- Operating temperature:** 0 to +55°C.
- Calibration accuracy:** (+10 to +40°C), ±0.7 dB 0.1 to 12 GHz. ±1.0 dB to 18 GHz. 0-10°C and 40-55°C: add ±0.2 dB.

Ordering Information

- 8900C Analog peak power meter
- 8900D Digital peak power meter
- 84811A Peak power sensor



NOISE FIGURE METER

Noise Measurements

Noise Figure

Modern receiving systems must often process very weak signals, and noise added by the receiving system components often determines whether or not an input signal can be processed properly. Noise figure is the figure of merit used to express how well a system and its components can process weak signals. It expresses the degradation in the S/N ratio as the signal passes through the system. Noise figure is unique and universal; it may be determined for transistors, amplifiers, mixers and entire systems. Considering the S/N ratio, it is often more economical to reduce the noise figure of the receiving system components than it is to increase the signal by increasing transmitted power or antenna gain.

Noise figure may also be expressed as the ratio of total output noise power (at a source temperature of 290K) compared to the output noise power if there were no noise added by the device under test (DUT), that is, a noise-free DUT. Consider the representation of the noise power at the output of a DUT vs. the temperature of the source impedance at the DUT input.

$$N_p = N_a + kGBT_s$$

Figure 1 is a graph of the equation. In equation, N_a is the noise added by the DUT, k is Boltzmann's constant, G is the gain of the DUT, B is bandwidth in Hz, and T_s is the temperature of the source termination, in Kelvins. Thermal agitation energy of the source impedance causes movement of the free-charge in that impedance. Energy of the moving charge that occurs within the bandwidth of the DUT, masquerades as input signal, gets processed by the DUT, and contributes to power output. At absolute zero, there is no thermal energy transferred from the source impedance and the only power at the output is noise added by the DUT, N_a . As the source temperature increases, the power output increases in accordance with the gain-bandwidth product and with Boltzmann's constant (which can be thought of as a conversion factor between two expressions for energy — kelvin temperature and joules). Noise figure is concerned with the behavior of the DUT compared to a noise-free DUT for a source temperature of 290K

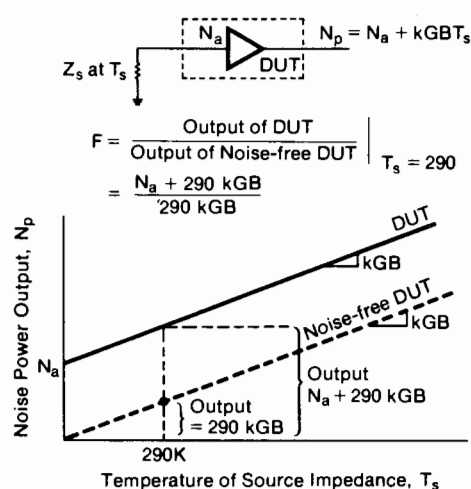

Figure 1. Available noise power and noise figure.

as shown in Figure 1. Noise figure is often expressed in dB by

$$F(\text{dB}) = 10 \log F$$

Effective Input Noise Temperature — (T_e)

Another figure of merit, the effective input noise temperature T_e , gives the noise performance without reference to a standard source temperature (290K). It is therefore commonly used for satellite system work where source temperatures are usually much lower than 290K. Once again the DUT output is compared to the output if no noise were added by the DUT (Figure 2). T_e is source temperature necessary for the source of the noise-free DUT to produce the same output noise power as the added noise of the actual DUT. For convenience, the DUT may be modeled as a noise-free DUT with an extra source impedance at temperature T_e .

Noise Figure Measurement

Noise figure meters measure two points along the straight-line for the DUT (Figure 3), and then display the corresponding noise figure. The two source temperatures correspond to the noise source being turned on (for T_h) and off (for T_c). The cold temperature of a noise source usually corresponds to the ambient temperature. The hot temperature of a noise source is specified indirectly by its excess noise ratio (ENR), which is given by

$$\text{ENR} = 10 \log \frac{T_h - 290}{290}$$

Before the microprocessor was employed in noise figure meters, several simplifying assumptions had to be made about the noise measurements for the analog circuits of the noise figure meter to display the noise figure. Increasing the measurement accuracy meant backing out the effect of those assumptions with a myriad of calculations and often further measurements. Assumptions commonly made included that T_c was equal to 290K, that T_h was constant at all frequencies, and that the added noise of the measurement system had a negligible effect on the measurement result.

A modern, microprocessor-controlled noise figure meter, the HP 8970A, eliminated those assumptions. It allows variable values of the T_c and it uses a stored table of ENR values at 20 or more frequencies for the particular noise source being used. The noise figure meter automatically interpolates among the stored ENR values for the proper value at each measurement frequency. Through system calibration, the 8970A measures the noise contribution of the measurement equipment and sets a gain reference. It can then correct for the noise figure of the measurement system and calculate and display the noise figure and gain of the DUT alone.

The microprocessor also adds a lot of needed conveniences. Examples include the display of effective input noise temperature, T_e , or of noise figure, simultaneous gain measurement, and correction of measurement results for adapter loss.

10 MHz to 26.5 GHz Noise Figure Measurement

The 8970A can be tuned or swept anywhere between 10 and 1500 MHz. For testing devices and components with output frequencies above 1500 MHz, down conversion to the 10 to 1500 MHz range is necessary (see Figure 4). For measurements on amplifiers from 2 to 26.5 GHz, adding a suitable, commercially available, double-balanced mixer and a suitable LO (such as the HP 8672A, 8673A, 8340A, or 8350A) to the 8970A and its companion 346 series noise sources is all that is necessary. (For mixer and receiver measurement, see Product Note 8970A-1 mentioned below.) Since most low-noise LO's do not extend below 2 GHz, a different technique is often required from 1.5 to 2 GHz (single sideband, discussed in the next section). Through system calibration, the 8970A corrects for the noise contribution of the mixer, LO, and the 8970A. In Figure 4, the 8970A sends frequency commands over the interface bus (HP-IB) to tune the LO across the frequency band of interest. Thus, no external controller is necessary for error-corrected, swept, microwave measurements.

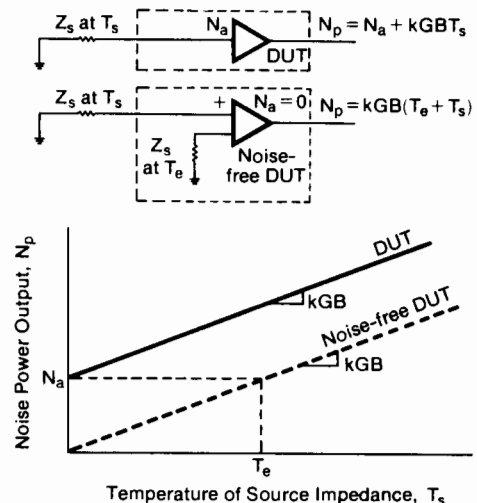

Figure 2. Available noise power & effective input noise temperature.

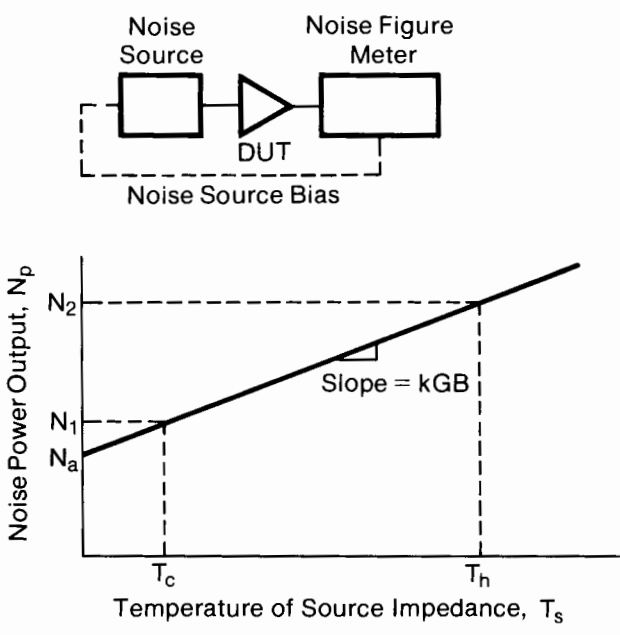

Figure 3. Available noise power and noise figure measurement.

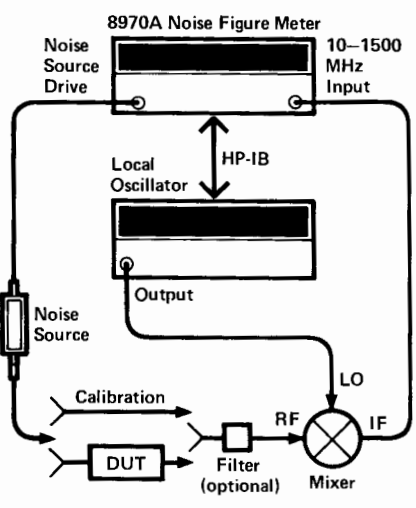

Figure 4. Swept microwave amplifier measurement.

Single Sideband vs. Double Sideband

When an ordinary mixer is used in the setup of Figure 4, all measurements are double sideband. (LO/Noise-source mixing provides two bands, upper and lower sideband, that will convert to the IF). Since the self-calibration and measurement are both double sideband, the 8970A will display the correct noise figure and gain. For double sideband measurement, it is best to have a low IF, since the measurement is like an average of upper and lower sideband values.

If double sideband measurement is inappropriate, such as when the DUT response varies rapidly with frequency or in the 1.5 to 2 GHz range mentioned above, a single sideband measurement must be made. For these

cases a high IF is best, so that the unwanted sideband may be easily filtered.

For 1.5 to 2 GHz amplifier measurements, for example, one method is to fix the LO to a proper frequency (such as 2.4 GHz), sweep the 8970A input (such as from 900 to 400 MHz), and the lower test sideband will sweep from 1.5 to 2 GHz. The upper sideband (sweeping from 2.8 to 3.3 GHz) may be filtered easily (an HP 360C works well). Another method uses a swept LO and an appropriate high fixed IF, with the 8970A controlling the external LO. In either case, the 8970A displays the measurement frequency during the sweep (1.5 to 2 GHz) and the microprocessor takes care of all of the control chores automatically.

Noise Figure Measurement Applications

Hewlett-Packard's noise figure measurement equipment is exceptional in a variety of applications. It exhibits the following benefits in these applications.

Amplifiers: 1) Simultaneous noise figure and gain measurement, 2) Results automatically corrected for ENR variations, ambient temperature, and mixer, LO, and IF noise contributions, 3) Real-time, swept, corrected output to oscilloscope for easy tuning (display is digitally stored), 4) Automatic control of an external LO for measurements above 1500 MHz without a separate computer.

Transistors: the above benefits, plus: 1) Easy real-time tuning for best noise figure and gain, 2) Real-time tuning to actual transistor F_{min} without second stage effects, 3) Easy single-sideband measurement (high 8970A IF makes filtering easy), 4) Low mismatch effects (the 346A features virtually identical impedance for T_h and T_c), 5) Easy to program for automatic systems.

Receivers and mixers: 1) Simultaneous measurement of gain (conversion loss) and noise figure, 2) Tunable and swept IF from 10 to 1500 MHz, 3) No external IF gain needed, 4) Automatic ENR correction, even for broadband sweeps, 5) Effects of LO power, IF power, and IF frequency changes on noise figure are easily observed, 6) Easy to program.

Literature

Product Note 8970A-1, *Applications and Operation of the 8970A Noise Figure Meter*, describes the 8970A and many of its applications in more detail. It is both an introduction to the 8970A and a summary reference manual.

Product Note 8350A-7, *Microwave Noise Figure Measurements Using the 8350A Sweep Oscillator with the 8970A Noise Figure Meter*, describes measurements with this popular combination of equipment.

Programming Note 8970A/HP 85-1, *Introductory Operating Guide for the 8970A Noise Figure Meter with the HP-85 Personal Computer*, shows the ease of programming the noise figure meter, local oscillator, and computer for automatic system using BASIC.

Application Note 57-1, *Fundamentals of RF and Microwave Noise Figure Measurements*, explains the theory behind noise figure and its measurement. This note includes an extensive glossary of noise related terms.



NOISE FIGURE METER

Automatic Noise Figure Meter, Noise Sources

Models 8970A, 346A/B/C

- Accurate and simple, swept or CW measurements.
- Automatic operation, 10 MHz—26.5 GHz.
- Second stage correction.
- Display of both noise figure and gain.
- Calibrated display on oscilloscope or recorder.
- Powerful special function enhancements.

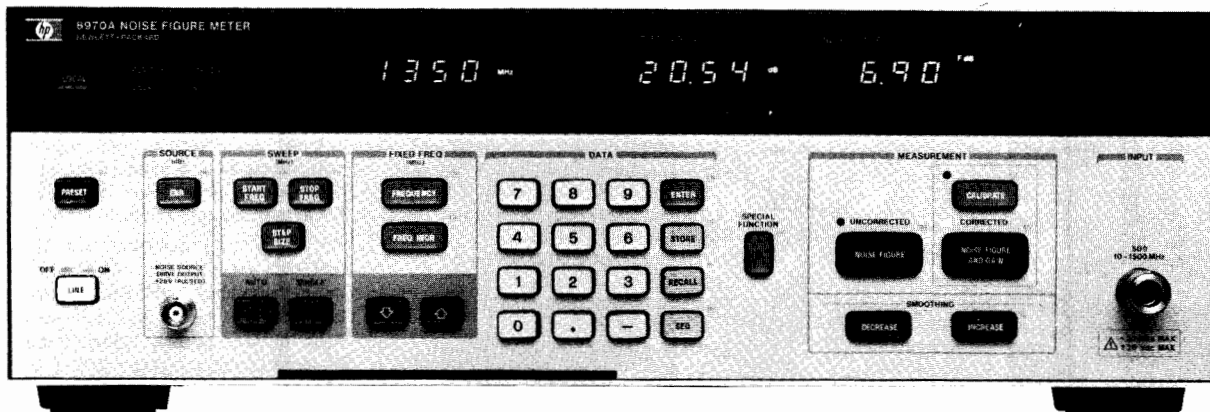

8970A

8970A Noise Figure Meter

With the 8970A Automatic Noise Figure Meter, accurate and repeatable noise figure measurements are now easy. RF and microwave (with an external local oscillator) measurements from 10 MHz to at least 26.5 GHz are equally simple; any IF between 10 and 1500 MHz may be used. The ENR (Excess Noise Ratio) calibration table of the noise source may be stored in the 8970A, and a properly interpolated value is automatically used at each frequency. Automatic second stage correction makes accurate noise figure readings possible even for low gain devices. The 8970A's dynamic range allows it to measure either gain up to at least 40 dB (higher in some cases) or loss to -20 dB, with no external attenuation or amplification required.

Microprocessor and Controller Functions

The 8970A takes the mystery out of noise figure measurement. It uses a microprocessor to make the myriad calculations and corrections necessary for truly accurate, convenient and flexible noise figure measurement. The 8970A also acts as a controller to external HP-IB local oscillators (such as the 8672A Synthesized Signal Generator or 8350A Sweep Oscillator) so that swept, broad-band microwave measurements of amplifiers, mixers, and transistors are essentially as simple as RF measurements.

In addition to acting as controller for an HP-IB local oscillator at microwave frequencies, the 8970A is fully programmable. Virtually all front panel buttons and functions are accessible over HP-IB, which is Hewlett-Packard's enhanced implementation of IEEE-488.

Simple Calibration and Second Stage Correction

Accuracy is greatly enhanced because the 8970A measures its own noise figure (and that of the rest of the measurement system) at up to 81 points. It stores this information, interpolates if necessary, and corrects for it to remove second stage (measurement system) effects. The 8970A also measures the gain of the device under test (DUT).

Display

The 8970A has an LED digital front panel display. For swept display of noise figure and gain on an oscilloscope, or x-y recorder, rear panel BNC Connectors are available. Either display mode is easily and accurately scaled from the 8970A from the front panel to any resolution desired. The swept oscilloscope display allows the design engineer to optimize his DUT in real time for both corrected noise figure and gain. The noise figure display is easily changed from noise figure to effective noise temperature (T_e) if desired, or Y factor.

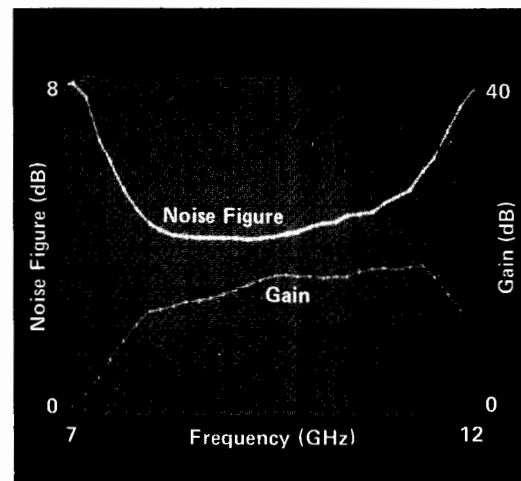

Typical oscilloscope display of amplifier.

Front Panel and Special Functions

The 8970A front panel buttons control the number entry, calibration, and measurement functions. STORE, RECALL, and SEQ buttons allow up to 9 front panel settings to be stored and sequenced automatically or manually to save set-up time. Smoothing INCREASE and DECREASE buttons are used to average up to 512 readings before display, to eliminate flicker and increase accuracy.

The simple front panel control of the 8970A satisfies many noise figure measurement needs. In addition, for those who may need even greater measurement power, there are more than 150 special functions that are easily selected via a numerical code and the SP button. Two examples are hot-cold measurements and automatic compensation for losses at the input of the DUT. One special function is a catalog that quickly indicates the current special function status. Three pull-out cards serve as a mini-reference manual to the instrument, including most of the special functions, the HP-IB formats and codes, and typical measurement setups. A complete set of service-oriented special functions can also be accessed.

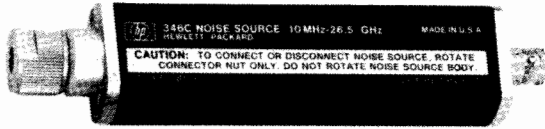

346C

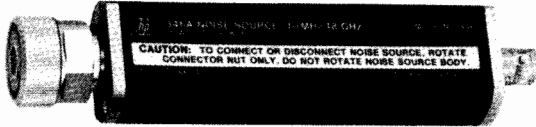

346A (option 002)

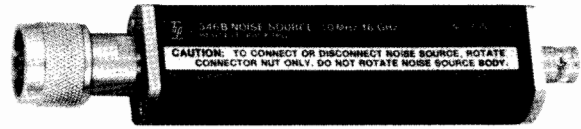

346B (option 001)

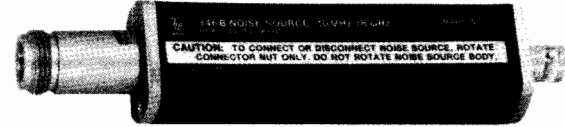

346B (option 004)

Noise Figure Measurement Repeatability and Accuracy

A very troublesome noise figure measurement problem is repeatability. For example, a vendor's system may not measure the same noise figure as his customer's. This is much less of a problem with the 8970A. Using randomly selected 8970A's, 346B's, mixers, and local oscillators, superimposed plots of a single DUT are routinely within 0.1 dB of each other.

The 8970A internal circuitry is so accurate and linear that instrumentation uncertainty is less than ±0.1 dB. With the ±0.1 dB ENR uncertainty of the 346B at most frequencies, and the uncertainties due to mismatch, total root-sum-square measurement uncertainties of less than ±0.25 are easily attainable.

346A/B/C Broadband Noise Sources

The ideal companion to the 8970A is the 346 family of noise sources. These noise sources, covering the microwave frequency range up to 26.5 GHz as well as the UHF and IF ranges, make it unnecessary to maintain a different noise source for each frequency band. Each source has individually calibrated values of ENR at cardinal frequencies printed on its label (see illustration) for easy loading into the 8970A. The low SWR of each noise source reduces a major source of measurement uncertainty—re-reflections of test signals. The variety of connectors available reduces the need for degrading accuracy with connector adapters.

The 346 family of noise sources are designed for a broad range of measurement applications. The 346C covers the broadest frequency range, 10 MHz to 26.5 GHz. The 346B has a high excess noise ratio, low SWR, and a variety of connectors to make it a general purpose noise source. The 346A is especially designed for accurately characterizing the noise figure of DUT's which do not include an isolator at the input, such as GaAsFET's and many UHF amplifiers. Without an isolator such devices can change gain during the noise figure measurement and thereby cause large errors in measuring noise figure. The 346A has a very small change in reflection coefficient (<0.01) from ON to OFF to minimize the gain changes. The ENR is large enough (~5.2 dB) to accurately measure noise figures of low noise GaAsFET's and UHF amplifiers.

FREQ GHz	ENR dB	FREQ GHz	ENR dB	FREQ GHz	ENR dB
0.01	5.31	0.01	15.10	0.01	13.25
0.10	5.57	0.10	15.49	0.01	13.43
1.0	5.36	1.0	15.25	1.0	13.49
2.0	5.17	2.0	15.17	2.0	13.52
3.0	5.02	3.0	14.93	3.0	13.35
4.0	4.98	4.0	14.96	4.0	13.58
5.0	4.97	5.0	14.91	5.0	13.57
6.0	4.94	6.0	14.83	6.0	13.80
7.0	4.99	7.0	14.90	7.0	14.04
8.0	5.09	8.0	15.05	8.0	14.33
9.0	5.26	9.0	15.25	9.0	14.56
10.0	5.36	10.0	15.39	10.0	14.55
11.0	5.28	11.0	15.43	11.0	14.77
12.0	5.21	12.0	15.50	12.0	15.04
13.0	5.02	13.0	15.41	13.0	15.16
14.0	4.93	14.0	14.93	14.0	15.37
15.0	4.96	15.0	15.51	15.0	15.42
16.0	4.99	16.0	15.25	16.0	15.66
17.0	5.04	17.0	15.52	17.0	15.62
18.0	5.05	18.0	15.56	18.0	15.91
				19.0	15.90
				20.0	16.13
				21.0	16.28
				22.0	16.22
				23.0	16.16
				24.0	16.18
				25.0	15.60
				26.5	15.60

346A 346B 346C
Example labels of 346 Noise Sources

346 Partial Specifications

(See technical data sheet for complete specifications.)

Frequency range: 10 MHz to 18 GHz for 346A/B; 10 MHz to 26.5 GHz for 346C.

Excess noise ratio (ENR) limits: 346A: 5 to 7 dB
 346B: 14 to 16 dB
 346C: 12 to 16 dB (10 MHz - 12 GHz)
 14 to 17 dB (12.0-26.5 GHz)

Maximum SWR (reflection coefficient) on and off: for 346A/B; 10 to 30 MHz — 1.3 (0.13), 30 MHz to 5 GHz — 1.15 (0.07), 5 to 18 GHz — 1.25 (0.11). For 346C; 10 MHz to 18 GHz — 1.25 (0.11), 18 to 26.5 GHz — 1.35 (0.15).

Power required: 28 ± 1 Vdc

Dimensions: 140 H x 21 W x 30 mm D (5.5" x 0.8 x 1.2")

Weight: Net, 0.108 kg (3.5 oz). Shipping, 0.5 kg (1 lb).

8970A Partial Specifications

(See technical data sheet for complete specifications.)

Noise figure measurement range: 0 to 30 dB.

Noise figure instrumentation uncertainty: ±0.1 dB for 0 to 55°C.

Noise figure resolution: 0.01 dB (0.001 dB over HP-1B)

Gain measurement range: -20 to at least 40 dB.

Gain instrumentation uncertainty: ±0.2 dB.

Gain resolution: 0.01 dB (0.001 dB over HP-1B)

Frequency range: tunable from 10 to 1500 MHz.

Tuning accuracy: (from 10 to 40°C) ± (1 MHz + 0.01 × freq.), 6 MHz maximum.

Frequency resolution: 1 MHz.

Noise figure: (for input power levels below -60 dBm) <7 dB + 0.003 dB/MHz.

Maximum operating input power: -10 dBm.

Maximum net external gain: 80 dB between noise source and 8970A RF input.

Noise source drive: 28.0 ± 0.1 volt

HP-1B capability: SH1, AH1, T5, L4, SR1, RL1, PP0, DC1, DT1, C1, C3, C28, E1.

Operating temperature: 0°C to 55°C.

Storage temperature: -55°C to 75°C.

Power: 100, 120, 220, or 240 V (+5, -10%); 48-66 Hz; 150 VA maximum.

Dimensions: 146 H x 425 W x 476 mm D (5.75" x 16.8" x 18.8").

Weight: net, 15.5 kg (34 lb). Shipping, 18.5 kg (40 lb).

Ordering Information

8970A Noise Figure Meter

Option 907: Front panel handle kit

Option 908: Rack mounting flange kit

Option 909: Both options 907 and 908

Option 910: Extra operating and service manual

346A Noise Source (Available Nov., 1983)

346B Noise Source

346C Noise Source (Available Nov., 1983)

Option 001 (346A/B only): Type N (male) connector

Option 002 (346A/B only): APC-7 connector

Option 004 (346A/B only): Type N (female) connector

NETWORK ANALYZERS

Complete Characterization of Linear Networks

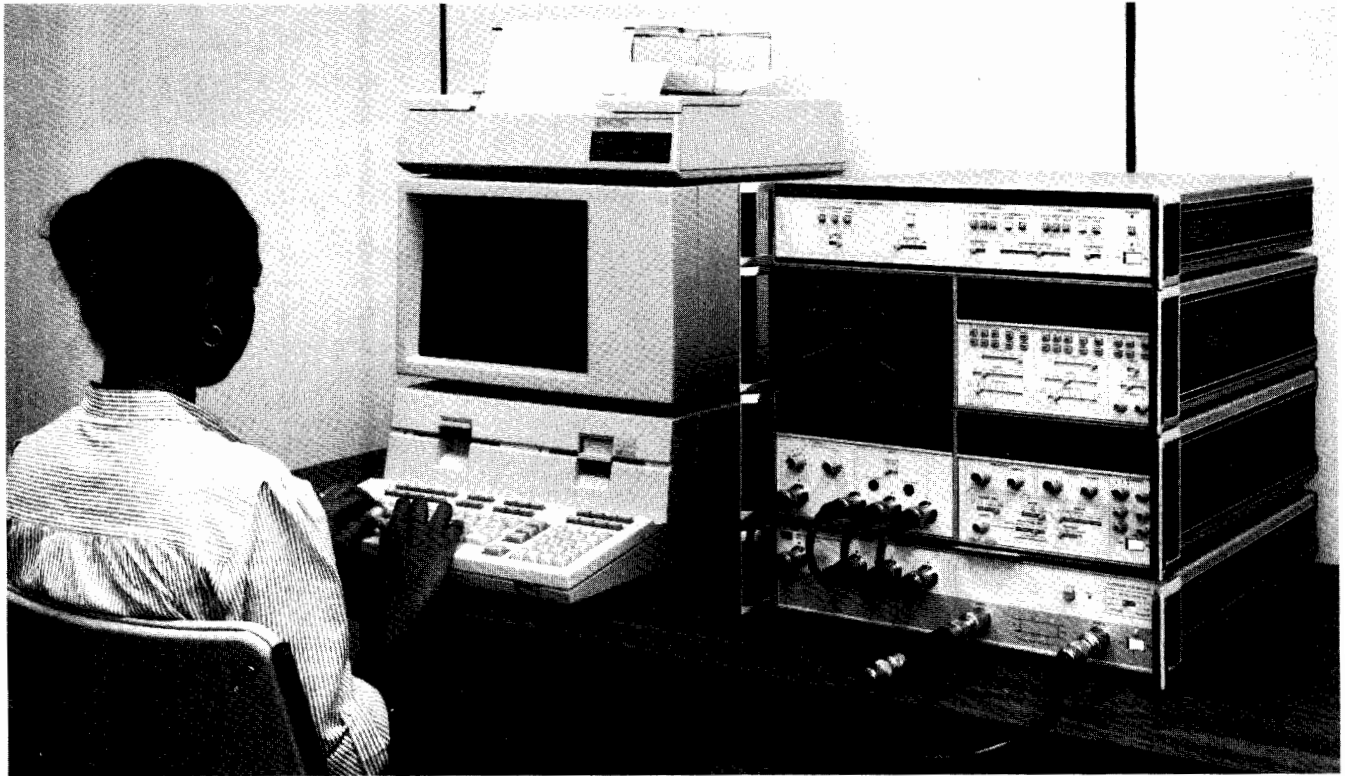

Why Network Analysis?

Characterizing the behavior of linear networks that will be stimulated by arbitrary signals and interfaced with a variety of other networks is a fundamental problem in both synthesis and test processes. For example, the engineer designing a multi-component network must predict with some certainty the final network performances from knowledge of the individual components. Similarly, a production manager must know allowable tolerances on the products manufactured and whether the final products meet the specified tolerances. Network analysis offers a solution to these problems through complete description of linear network behavior in the frequency domain.

Network analysis accomplishes the description of both active and passive networks by creating a data model of such component parameters as impedances and transfer functions. However, these parameters not only vary as a function of frequency but are also complex variables in that they have both magnitude and phase. Until the advent of the modern network analyzer, phase was difficult to measure at CW frequencies and often involved laborious calculations; these measurements were accomplished by conventional oscilloscopes at lower frequencies and slotted lines at microwave frequencies. However, swept network analyzers now measure magnitude and phase (the total complex quantity) as a function of frequency with less difficulty than conventional CW measurements. Impedance and transfer functions can then be conveniently displayed on a swept CRT, as in Figure 1, X-Y recorder, or computer controlled peripherals such as a printer and/or a plotter. HP computers also combine

with network analyzers to give new levels of speed and accuracy in swept measurements that could only be attained previously by long calculations at CW frequencies.

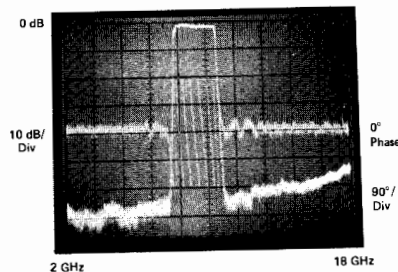

Figure 1. 2 GHz to 18 GHz measurement of magnitude and phase in a single sweep

Thus, network analysis satisfies the engineering need to characterize the behavior of linear networks quickly, accurately, and completely over broad frequency ranges. In design situations, this minimizes the time required to test new designs and components, allowing more time to be spent on the design itself. Likewise, production test times may be minimized while reducing the uncertainties surrounding the test. Hewlett-Packard manufactures a full line of Scalar Network Analyzers (magnitude only) and Vector Network Analyzers (both magnitude and phase).

What Is Network Analysis?

Network analysis is the process of creating a data model of the transfer and/or imped-

ance characteristics of a linear network through stimulus-response testing over the frequency range of interest. All network analyzers in the HP product line operate according to this definition.

Creating a data model is important in that actual circuit performance often varies considerably from the performance predicted by calculations. This occurs because the perfect circuit element doesn't exist and because some of the electrical characteristics of a circuit may vary with frequency.

At frequencies above 1 MHz lumped elements actually become "circuits" consisting of the basic elements plus parasitics like stray capacitance, lead inductance, and unknown absorptive losses. Since parasitics depend on the individual device and its construction they are almost impossible to predict. Above 1 GHz component geometries are comparable to a signal wavelength, intensifying the variance in circuit behavior due to device construction. Further, lumped-element circuit theory is useless at these frequencies and distributed-element (or transmission-line) parameters are required to completely characterize a circuit.

Data models of both transfer and impedance functions must be obtained to completely describe the linear behavior of a circuit under test. At lower frequencies, h, y, and z-parameters are examples of transfer and/or impedance functions used in network description; at higher frequencies, S-parameters are used to characterize input-output impedances and transfer functions. Therefore, a network analyzer must measure some form of a circuit's transfer and impedance functions to achieve its objective of complete network characterization. Figure 2 shows an example of a swept impedance measurement.

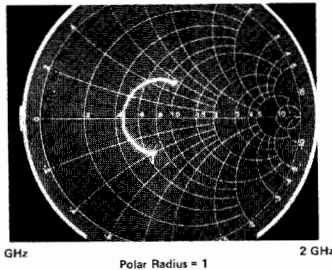

Figure 2. Input impedance of microcircuit amplifier is read directly with Smith Chart Overlay for Polar Display

Network analysis is generally limited to the definition of linear networks. Since linearity constrains networks stimulated by a sine wave to produce a sine wave output, sine wave testing is an ideal method for characterizing magnitude and phase response as a function of frequency. In non-linear measurements phase is often meaningless and amplitude has to be defined with respect to individual frequency components. For non-linear measurements see sections on spectrum analyzers and wave analyzers.

Network Analyzers

Hewlett-Packard Network Analyzers are instruments that measure transfer and/or impedance functions of linear networks through sine wave testing. A network analyzer system accomplishes these measurements by configuring its various components around the device under test. The first requirement of the measurement system is a sine wave signal source to stimulate the device under test. Since transfer and impedance functions are ratios of various voltages and currents, a means of separating the appropriate signals from the measurement ports of the device under test is required. Finally, the network analyzer itself must detect the separated signals, form the desired signal ratios, and display the results.

Signal Sources and Signal Separation

In the general case, any sine wave source meeting the network analyzer's specifications can be used to stimulate the device under test. For CW measurements a simple oscillator may suffice; for greater CW frequency accuracy a signal generator or synthesizer may also be desirable. If the analyzer is capable of swept measurements, great economies in time can be achieved by stimulating the device under test with a sweep oscillator or sweeping synthesizer. This allows quick and easy characterization of devices over broad frequency ranges. Some network analyzers will operate only with a companion source that both stimulates the device under test and acts as the analyzer's local oscillator.

At low frequencies it is not particularly difficult to separate the appropriate voltages and currents required for transfer and impedance function measurements. Signal separation is merely the process of establishing the proper shorts, opens, and connections at the measurement ports of the device under

test. As frequencies increase, the problem of signal separation usually involves traveling waves on transmission lines and becomes correspondingly more difficult. Hewlett-Packard manufactures test sets (often called "transducers") applicable for separating the appropriate traveling waves in a variety of high frequency measurements.

Broadband and Narrowband Detection

After the desired signals have been obtained from the test set (or transducer) they must be detected by the network analyzer; HP network analyzers can use one of two detection methods. Broadband detection accepts the full frequency spectrum of the input signal while narrowband detection involves tuned receivers which convert CW or swept RF signals to a constant IF signal. There are certain advantages to each detection scheme.

Scalar Network Analyzers usually employ broadband detection techniques. Broadband detection reduces instrument cost by eliminating the IF section required by narrowband analyzers but sacrifices noise and harmonic rejection. However, noise is not a factor in many applications, and careful measurement techniques, using filters, can eliminate harmonic signals that would otherwise preclude accurate measurements. Broadband systems are generally source independent while some narrowband systems require companion tracking sources. Finally, broadband systems can make measurements where the input and output signals are not of the same frequency, as in the measurement of the insertion loss of mixers and frequency doublers. Narrowband systems cannot make these measurements.

Vector Network Analyzers normally employ narrowband detection techniques. Narrowband detection makes a more sensitive low noise detection of the constant IF possible. This allows increased accuracy and dynamic range for frequency selective measurements (as compared to broadband systems) and high resolution through IF substitution using precision IF attenuators. Source dependent narrowband systems utilize a companion tracking source not only to stimulate the device under test, but also to produce a signal offset from the RF by a fixed frequency for tuning the analyzer's constant IF.

Signal Processing and Display

Once the RF has been detected, the network analyzer must process the detected signals and display the measured quantities. All HP network analyzers are multi-channel receivers utilizing a reference channel and at least one test channel; absolute signal levels in the channels, relative signal levels (ratios) between the channels, or relative phase difference between channels can be measured depending on the analyzer. Using these measured quantities, it is possible to either display directly as shown in Figure 2, or compute the magnitude and phase of transfer or impedance functions.

Magnitude measurements fall into two categories, relative and absolute; absolute measurements involve the exact signal level

in each channel while relative measurements involve the ratios of the two signal channels. Absolute measurements are usually expressed in voltage (dBV) or in power (dBm). The units dBV are derived by taking the log ratio of an unknown signal in volts to a one volt reference. Similarly, dBm is the log ratio of unknown signal power to a one milliwatt reference.

Relative ratio measurements are usually made in dB, which is the log ratio of an unknown signal (Test Channel) with a chosen reference signal (Reference Channel). This allows the full dynamic range of the instrumentation to be used in measuring variations of both high and low level circuit responses. For example, 0 dB implies the two signal levels have a ratio of unity while ± 20 dB implies a 10:1 voltage ratio between two signals.

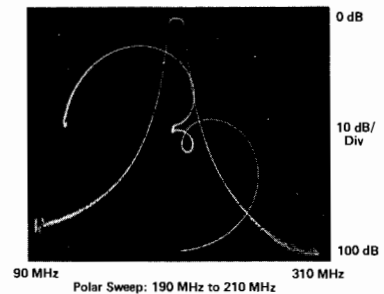

Figure 3. Simultaneous measurement of transmission response and passband reflection coefficient

All network analyzer phase measurements are relative measurements with the reference channel signal considered to have zero phase. The analyzer then measures the phase difference of the test channel with respect to the reference channel.

Measurement results at CW frequencies may be displayed on analog meters, LEDs or computer controlled printers. Swept frequency measurements of amplitude and phase may be displayed versus frequency on CRTs or X-Y plotters. Insertion Loss is displayed in two different ways in Figure 4. The addition of digital storage and normalization to network analyzer CRTs assures flicker-free traces and removal of frequency response errors for fast, real-time displays of test device responses versus frequency.

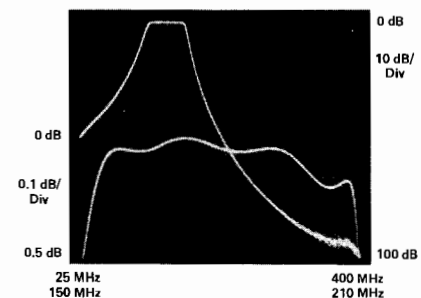

Figure 4. Simultaneous measurement of filter passband and skirts using alternate sweep



NETWORK ANALYZERS

Complete Characterization of Linear Networks (cont.)

Low Frequency Network Analysis

Networks operating at frequencies below 10 MHz are generally characterized by measuring the gain and phase changes through the network and the associated input and output impedances; h , y , and z -parameters as well as other lumped-component models are typical analytical and computational tools used to represent these measurements. The first derivative of phase with respect to frequency, group delay, is an important measurement of distortion in communication systems. Hewlett-Packard produces a broad line of instrumentation capable of measuring all of these parameters.

Phase information complements amplitude data in the measurement of low frequency parameters. Phase is more sensitive to network behavior and it is a required component of complex impedance and transfer functions. For instance, phase is required to determine the frequency of network resonances (poles) and anti-resonances (zeroes). This is because the phase shift of a network transfer function is exactly zero at the frequency of resonance. Phase information is also vital in circuit design, particularly loop design, where phase margins are critical.

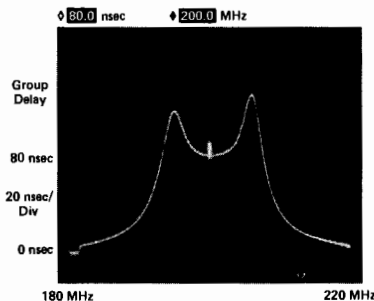

Figure 5. Direct Measurement of Group Delay with digital readout at marker

Phase data is also required to measure delay distortion or group delay of networks. Delay distortion occurs when different frequency components of a complex waveform experience nonlinear phase shifts as they are transmitted through a network. Group delay is a measure of this distortion and is defined as:

$$T_g = -\frac{d\theta}{d\omega}$$

There are several techniques for measuring group delay; the most common techniques are phase slope, amplitude modulation, frequency modulation, and frequency deviation. Most HP network analyzers can make measurements with at least one of these techniques while several analyzers measure and display group delay directly. Choice of a group delay measurement technique is dependent on the particular device under test and the resolution required.

An alternative method for measuring phase distortion is deviation from linear phase or differential phase. Deviations from linear phase can be measured by introducing enough electrical length in the network analyzer's reference channel to linearize a device's phase shift. Once this has been accom-

plished it is possible to observe any variations in phase shift linearity at high resolution. Since group delay is the derivative of phase ($d\theta/d\omega$), nonlinearities in phase shift correspond directly to changes in a device's group delay. Figure 6 shows deviation from linear phase and group delay. Introduction of electrical length in the measurement channel may be accomplished by physically adding cable, or it may be accomplished electronically on some network analyzers.

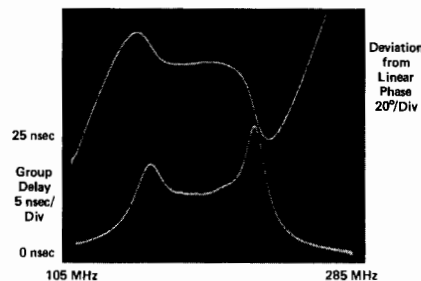

Figure 6. Two independent techniques for measuring filter phase distortion

At lower frequency (typically ≤ 50 kHz) digital signal analysis using Fast Fourier Transformations (FFT) can also be used to determine the magnitude and phase of transfer characteristics. This subject is treated in the Signal Analysis section of this catalog.

High Frequency Network Analysis

Measurements of voltages and currents become more and more difficult as frequency increases. Consequently, h , y , and z parameters lose their usefulness at high frequencies. High frequency network behavior can be better described using transmission line theory in terms of forward and reverse traveling waves. Thus, travelling waves make a logical replacement for voltages and currents in high frequency measurements.

Scattering parameters or S-parameters were developed to characterize linear networks at high frequencies. S-parameters define the ratios of reflected and transmitted traveling waves measured at the network ports. Figure 7. S_{11} is the complex re-

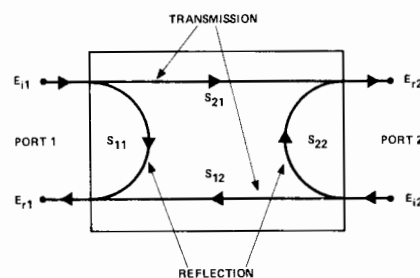

Figure 7. S-parameter model for a two-port linear network

lection coefficient at port 1 and is the ratio of E_r/E_i , if $E_i = 0$ (port 2 terminated in its characteristic impedance). S_{21} is the complex transmission coefficient from port 1 to port 2, E_r/E_i , if $E_i = 0$. E_i and E_r represent the amplitude and phase of the incident and emerging or reflected traveling waves. By reversing the ports and terminating port 1 in its characteristic impedance, S_{22} and S_{12} can be similarly defined. From these definitions, the following equations can be derived:

$$E_r1 = S_{11}E_i1 + S_{12}E_i2$$

$$E_r2 = S_{21}E_i1 + S_{22}E_i2$$

where incident signals act as independent variables determining the signals leaving the network. The definition of an S-parameter can be easily extended to multiport networks; measurement is also easily accomplished by terminating additional ports in their characteristic impedances. Thus, S-parameters completely describe linear network behavior in the same manner as low frequency parameters.

S-parameters offer numerous advantages to the microwave engineer because they are both easy to use and easy to measure. They are easy to measure because the device is terminated in its characteristic impedance allowing swept broadband frequency measurement without tuning, enhancing the stability of active devices, and permitting a test set up to be used for different devices. The design process is simplified because S-parameters are directly applicable to flow graph analysis. HP network analyzers and the appropriate test sets will measure and directly display S_{21} or S_{12} as gain or attenuation and S_{11} or S_{22} as reflection coefficient, return loss or impedance. Figure 8 shows measurements of both S_{21} and S_{11} . Also, S-parameters may be directly related to h , y , and z -parameters through algebraic transformations.

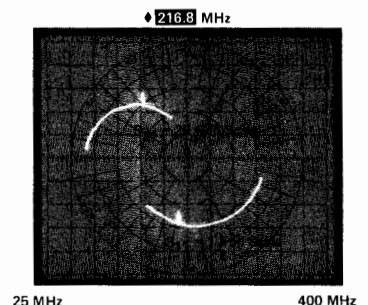

Figure 8. Simultaneous measurement of transistor S-parameters

Additional Capabilities

The computational capabilities of a digital computer can complement the network analyzer's versatility through simplifying and speeding measurements, data processing, and accuracy enhancement. Hewlett-Packard has combined network analyzers and computers into measurement systems and now offers some analyzers that may be easily interfaced with HP desktop computers through the Hewlett-Packard Interface Bus.



Precision design work and manufacturing tolerances demand highly accurate measurements, but most errors in network measurements are complex quantities that vary as a function of frequency, making manual error correction prohibitive. However, the computer can make great contributions to measurement accuracy by quickly and easily performing the complex mathematics for sophisticated error correction.

Aside from new levels of accuracy, computer controlled network analyzers can be programmed to set up and make many measurements automatically. The measurement process is further accelerated by the computer's ability to store, transform, summarize, and output data in a variety of formats to a number of peripherals. These capabilities make the computer controlled network analyzer ideal for both computer aided design or automatic production testing.

Network Analyzer Product Line

Hewlett-Packard offers a complete line of network analyzers capable of measurements through the 1 Hz to 40 GHz frequency range. Further information and detailed specifications on individual network analyzers are available on the following pages (see matrix on page 429 for specific page numbers).

3575A

The 3575A measures Phase and Amplitude or Gain. With the 3575A, the complete response picture is available at a reasonable cost from a single instrument, over an 80 dB range, from 1 Hz to 13 MHz. The 3575A uses a broadband measurement technique, which is attractive because the measurement is not constrained by internal tracking source or dedicated external device. The 3575A is not dependent on the wave shape, thus measurements can be made on a variety of waveforms such as triangle and square waves.

3040A

The 3040A is a network analysis system capable of measuring amplitude, phase, and group delay to 13 MHz. The system consists of a synthesizer signal source and a two-channel tracking detector. Measurement applications include filter design and production, amplifier testing, delay measurements on communication devices, and measurements on any linear two-port device.

8407A

The 8407A Network Analyzer tracks the 8601A generator/sweeper (or the 8690B/8698B sweeper) from 100 kHz to 110 MHz. Measurement capabilities include:

- 1) Transmission (gain, loss, phase shift) and reflection (return loss, impedance) measured quickly and easily in either 50 Ω or 75 Ω by sweeping over the frequency range of interest.
- 2) Complex impedance [Z], θ , or $R \pm jX$ over the wide impedance range 0.1 Ω to >10 k Ω .
- 3) Voltage and current transfer functions.

4) High impedance in-circuit probing.

A rectangular and polar display and various CRT overlays permit direct readings of parameters of interest as frequency is swept. Applications are detailed in Application Notes 121-1 and 121-2.

8405A

The 8405A Vector Voltmeter is a dual-channel RF millivoltmeter and phasemeter. It reads the absolute voltages on either of two channels and simultaneously determines the phase relationship between them. CW measurements can be made over the frequency range 1 MHz to 1 GHz.

Besides its use as a voltmeter, applications of the 8405A include:

- 1) Transmission measurements (gain, loss, phase shift and return loss) in 50 Ω systems.
- 2) Group delay and amplitude modulation index.
- 3) In-circuit probing.
- 4) S-parameters in 50 Ω systems.

Application Notes 77-1, 77-3, 77-4, and 91 are available for more detail on the above measurements.

8754A

The 8754A is a completely integrated stimulus/response system for testing a wide variety of networks (like filters, amplifiers, and attenuators) in the 4 to 2600 MHz frequency range. By combining a swept source, three channel tuned receiver, and polar/rectilinear CRT display into a single compact package, outstanding performance can be achieved at an economical price. Magnitude, phase, polar reflection coefficient and impedance are all measured directly over 80 dB of spurious free dynamic range. Frequency accuracy is provided by a crystal marker system and since three receiver inputs are available, network transmission and reflection parameters can be measured simultaneously. Additionally, a complete line of 50 Ω and 75 Ω power splitters, transmission/reflection test sets, and S-parameter test sets, are available. High impedance probe can also be used if necessary and an external signal generator can be used directly to characterize narrow-band devices like crystal filters.

8505A/8507D

The 8505A Network Analyzer provides measurement capability from 500 kHz to 1.3 GHz. Three RF input ports, each with 100 dB of dynamic range, make possible simultaneous network measurements of reflection and transmission parameters. Two independent yet identical display channels are each capable of displaying magnitude, phase, deviation from linear phase and group delay of either the transmission or reflection characteristics of an RF network. These parameters can be displayed in rectangular, in polar coordinates or both formats at the same time. The swept source, which is an integral part of the analyzer, offers extreme frequency flexibility through seven different modes of operation.

The 8507D is an Automatic Network Analyzer using the 8505A with HP-IB interface and one of the 9816S, 9826S, or 9836S Computers as a controller. The 8507D is well suited for laboratory applications because of the accuracy enhancement software supplied with the system. The 8507D is also well suited for manufacturing applications where fast, repeatable testing is necessary. Test data can also be reformatted and outputted to an external plotter for permanent documentation.

8410C/8408B/8409C

The 8410C network analyzer system measures the transmission and reflection characteristics of linear networks in the form of gain, attenuation phase shift, reflection coefficient, normalized impedance and S-parameters in the frequency range of 110 MHz to 40 GHz.

The 8410C is a ratiometer using both reference and test signal inputs; consequently, the sweeper output must be divided into channels. This is accomplished by a "Test Set" whose other major function can be to provide the switching required for making transmission and reflection measurements with minimum or no changes in the measurement setup. Hewlett-Packard offers test sets covering various frequency ranges and switching functions.

Another major instrument required in the 8410 measurement system is a unit for the detection and display of the IF amplitude and phase. Three plug-in displays (for the 8410C mainframe) are available for this purpose: a phase-gain indicator with meter readouts for CW measurements; a phase-gain display for displaying log amplitude and phase versus frequency; and a polar display for displaying amplitude and phase in polar coordinates.

The 8410C is capable of swept measurements over multi-octave bands through 18 GHz. Between 18 GHz and 40 GHz, 2 GHz windows may be viewed. Measurements of more than 60 dB of attenuation and 40 dB of gain are possible.

The 8409C Automatic Network Analyzer System is a practical solution to the need for automatic error-corrected RF and microwave network measurements using a simple and economical configuration. It is a complete measurement system consisting of the programmable 8350B Sweeper, the 8410C Network Analyzer System, and the 9845B, 9826A or 9836A Desktop Computer. It brings the major advantages in accuracy, speed, data collection, and operating convenience at a modest cost increase over the manual network analyzer system. Further information is available in Application Notes 117-1, 117-2 and 221A.

The 8408B is a low cost, programmable network measurement system based on the 8410C Network Analyzer, the 8350B Sweeper and the 85F Desktop Computer. Using automatic error correction techniques, primarily in reflection, the 8408B offers the capability of making more accurate measurements than with the 8410C manual system.



Scalar Network Analyzers

Scalar (magnitude only) Network Analyzers use economical broadband diode detectors for swept frequency measurements. These detectors, along with broadband bridges, permit transmission and reflection measurements from 10 MHz to 26.5 GHz with one system. Because many devices can be sufficiently characterized by magnitude versus frequency measurements the need for complex, costly phase measuring circuitry in the network analyzer is eliminated. A scalar measurement system usually consists of a scalar network analyzer, sweep oscillator, detectors and a signal separation device (such as a directional coupler or bridge). In addition, many scalar systems utilize computers for automatic testing and data collection. Scalar network analyzers have enjoyed wide acceptance in research and development, manufacturing and field service testing applications.

8756A/8756S

The 8756A Scalar Network Analyzer is microprocessor based scalar analyzer for swept frequency transmission and reflection measurements. The 3 detector inputs can be displayed on either display channel in an absolute power measurement mode (A, B or R) or in a ratio measurement mode (A/R, B/R, A/B). A built-in trace memory for each channel enables normalized measurements to be made at any resolution or offset. A fully annotated graphics CRT displays the measurement trace, scale per division (in dB), input being measured (A, B, etc.), and start and stop sweep frequencies (when using an 8350B Sweep Oscillator or 8340A Synthesized Sweeper). Any trace can be instantly displayed by pressing the AUTOSCALE key. This automatically scales the dB/div, and reference line so that the entire trace is on screen. This function eliminates the need to spend any time adjusting the analyzer to get a new trace on screen after changing test devices or instrument settings.

Alongside the CRT are several keys whose functions are defined in ROM internal to the 8756A. These keys perform various measure-

ment functions depending on the current measurement menu in use. The effect of these soft keys is to make available a wide variety of measurement functions while eliminating front panel complexity. Some of the major soft key functions available are a cursor for precise, high resolution amplitude and frequency measurements at any point on the display; a direct digital plot output (without computer) to HP-IB plotters or CRT trace, graticule and annotation for measurement documentation; digital averaging (selectable from 2 to 256 traces) for noise reduction and higher resolution measurements and calibration procedures such as open/short averaging and detector offset for improving measurement accuracy.

A wide variety of accessories such as detectors, power splitters and directional bridges are also available. In particular directional bridges in several connector types are available from 10 MHz to 40 GHz with high (>40 dB) directivity for very accurate measurements.

The 8756A will operate with any general purpose sweep oscillator however a special, dedicated interface exists between the 8756A and 8350B Sweep Oscillator (or 8340A Synthesized Sweeper). This System Interface Bus enables the 8756A to act as a system controller providing the frequency annotation (read at the end of each sweep) on the CRT as well as allowing for the storage and recall of system, ie. both analyzer and sweeper instrument settings. That is, the sweeper and analyzer settings can both be saved by only pressing the save keys on one of the instruments.

Control of the 8756A is handled by an internal 16 bit microcomputer inside the analyzer. Because of this, all functions and front panel controls are programmable via the Hewlett-Packard Interface Bus (HP-IB) via simple 2 letter codes. In addition to complete programmability, the 8756A can output data back to a computer extremely fast. A 401 point trace of measurement data can be transmitted back to a computer in as fast as 35 milliseconds. With easy programming and fast data transfer capabilities the 8756A Scalar Network Analyzer is the ideal instru-

ment for automatic systems.

The 8756S Automatic Scalar Network Analyzer is a microwave measurement system capable of fully automated transmission and reflection testing. The 8756S consists of the 8756A Scalar Network Analyzer, 8350B Sweep Oscillator (with appropriate RF Plug-in), a directional bridge and detector, and a computer for control of the system.

The core of the 8756S is the 85015A System Software. Not only does this provide the automatic control of the instruments but the 85015A's modular measurement routines enable the user to custom configure often used measurement sequences. Because of this it is not necessary to proceed through the initial operator prompts and instrument set up steps when doing a frequently performed test such as a final test or incoming inspection check. For further information refer to page 430.

8755C/8755S

The 8755S is an economy scalar network measurement system designed to make absolute power and ratio measurements from 10 MHz to 26.5 GHz. The 8755S consists of the 8755C Swept Amplitude Analyzer plug-in that fits into a 182T display unit, an 8750A Storage Normalizer and 3 11664A diode detectors. The 8755S can be operated with any general purpose sweep oscillator (such as the 8350B or 8620C). In addition to its long established use in laboratory applications the size and portability of the 8755S make it well suited for field service and manufacturing environments.

The 8755C has two independent display channels and 3 detector inputs that permit the simultaneous display of reflection and transmission characteristics. The 8750A Storage Normalizer will store in memory a trace for each channel and subtract it from the measured trace for normalized measurements. A complete family of directional bridges in a variety of connector types and frequency ranges from 10 MHz-26.5 GHz offer high directivity (>40 dB) for very accurate measurements. For further information refer to page 438.

Network Analyzer Product Line Summary

Model	Frequency Range	Source	Measurement Capabilities
3582A Spectrum Analyzer Page 517	20 mHz to 25.599 kHz	Built-in source that is selectable as either random or pseudorandom. The noise signal is automatically band-limited and band-translated to match the analysis.	Transfer function amplitude and phase. Coherence function. Transient capture and analysis.
5420B Digital Signal Analyzer Page 523	16 mHz-25.6 kHz	Built-in random noise source, band limited.	Transfer function, coherence, power spectral density, Histogram, time record average, impulse response.
3575A Gain Phase Meter Page 442	1 Hz-13 MHz	None	Gain, Phase and Amplitude Low Frequency Analysis
3040A Manual Network Analyzer Page 440	50 Hz-13 MHz	3320B or 3330B Synthesizer	Amplitude and Phase Group Delay Gain or Loss Linear Frequency Sweep
8407A Network Analyzer Page 456	100 kHz-110 MHz	8601A Generator / Sweeper	Transfer Functions, Impedance in 50 Ω , 75 Ω Systems Complex Impedance 0.1 Ω to >10 k Ω High Impedance In-Circuit Probing S-parameters in 50 Ω , 75 Ω systems
8405A Vector Voltmeter Page 447	1 MHz-1 GHz (CW)	3200B Oscillator, VHF Signal Generators, 8654 (UHF), and 8640 A/B	Voltmeter Transfer Functions, Impedance in 50 Ω systems Group Delay, Amplitude Modulation Index S-parameters in 50 Ω systems
8754A Network Analyzer Page 444	4-2600 MHz	Swept source included external source usable.	Magnitude and phase transmission coefficient reflection coefficient and return loss S-parameters, impedance.
8505A RF Network Analyzer Page 448	500 kHz-1.3 GHz	Swept Source Included	Complex Transfer functions—Gain/Loss or S-parameters Complex Impedance— Γ , Return Loss, $R \pm jX$ Distortion—Group Delay, Deviation from Linear Phase Digital Readout of Data while sweeping Frequency Counter included HP-IB with Learn Mode
8507S Automatic Network Analyzer Page 454	500 kHz-1.3 GHz	Swept Source Included	8507D Network Analyzer Subsystem 85011A System Software 9816, 9826, or 9836 Computer Automatic Measurements with Data Formatting and Graphics. Error corrected measurements.
8755S Frequency Response Test System Page 438	10 MHz-40 GHz	8350 or 8620 Series Sweep Oscillators	Scalar Transmission/Reflection Measurements 50 Ω Coax Measurements 10 MHz-20 GHz 75 Ω Coax Measurements 10 MHz-2.4 GHz Waveguide Measurements 18 GHz-40 GHz
8756A Scalar Network Analyzer Page 431	10 MHz-40 GHz	8350 or 8620 Series Sweep Oscillators, 8340A Synthesized Sweeper	Scalar Transmission/Reflection Measurements 50 Ω Coax Measurements 10 MHz-20 GHz 75 Ω Coax Measurements 10 MHz-2.4 GHz Waveguide Measurements 18 GHz-40 GHz Open/Short Averaging, Normalization, Averaging Storage Registers, HP-IB Programmable
8756S Automatic Scalar Network Analyzer Page 430	10 MHz-40 GHz	8350 Series Sweep Oscillators, 8340A Synthesized Sweeper	Automatic Scalar Transmission/Reflection Measurements Custom configurable test sequences Automatic data collection and storage 9816, 9826 or 9836 Computer
8410C Network Analyzer Page 458	110 MHz-40 GHz	8350, 8620 Series Sweep Oscillators	Transmission/Reflection Characteristics, S-Parameters 50 Ω Coax Measurements 110 MHz to 18 GHz Waveguide Measurements 8.2 GHz to 40 GHz Continuous Multioctave Measurements with 8620 and 8350 Series Sweepers DC Bias for Semiconductor Measurements
8409S Automatic Network Analyzer Page 467	110 MHz-18 GHz	8350 or 8620 Series Sweep Oscillators	Automatic Transmission/Reflection Measurements Full Error Correction in Transmission/Reflection Measurements 8410C Network Analyzer System 9826A/9836A or 9845B Desktop Computer
8408S Automatic Network Analyzer Page 466	110 MHz-18 GHz	8350 or 8620 Series Sweep Oscillators	Automatic Transmission/Reflection Measurements Full Error Correction in Reflection Measurements Tracking Error Correction in Transmission Measurements 8410C Network Analyzer System 85F Desktop Computer

NETWORK ANALYZERS

Automatic Scalar Network Analyzer System, 10 MHz to 40 GHz

Model 8756S

- Measure insertion loss, gain, power, VSWR
- Custom test sequences without programming
- Plot or display data

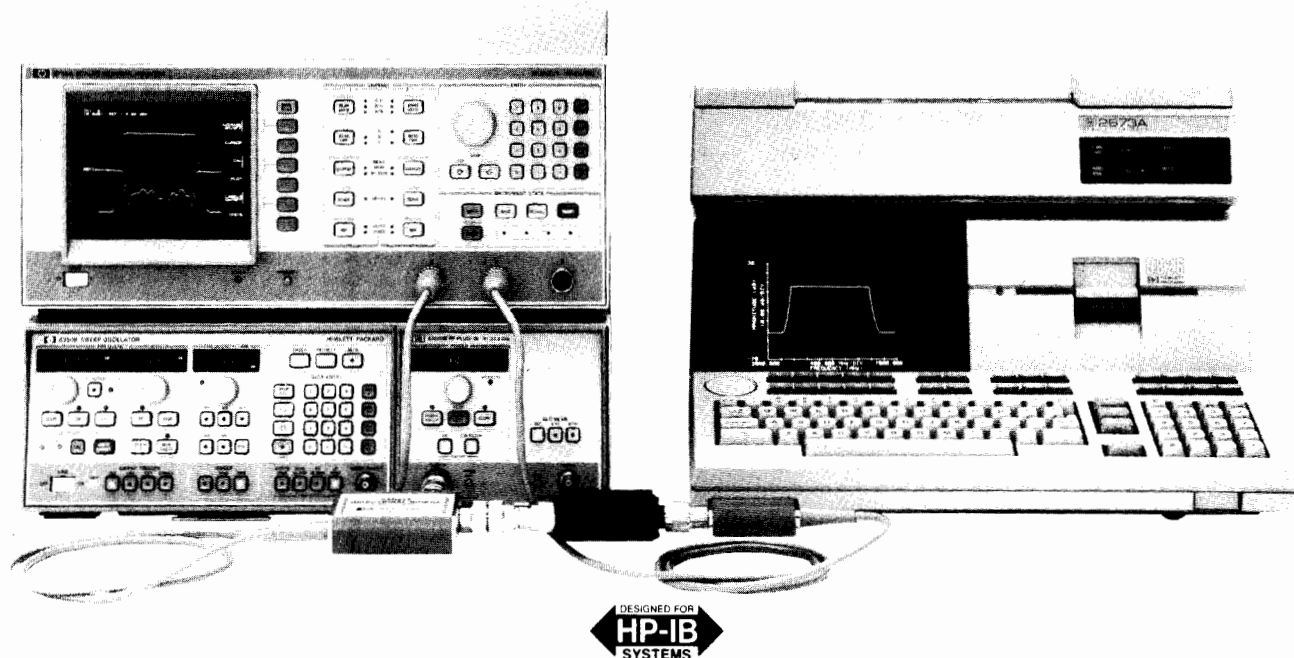

Description

The HP 8756S is an Automatic Scalar Network Analyzer that can measure insertion loss (or gain) and return loss from 10 MHz to 40 GHz. Control for this automatic system is provided through the Hewlett-Packard Interface Bus (HP-IB). Included in this system are an HP 8756A Scalar Network Analyzer, an HP 8350B Sweep Oscillator with an RF Plug-in or an HP 8340A Synthesized Sweeper, one of the high directivity (40 dB) HP 8502X Directional Bridges, detectors and accessories under the control of an HP 9816, 9826, or 9836 Computer and HP 85015A System Software. All 8756A, 8350B and 8340A controls are completely programmable.

Increase Productivity

The 85015A System Software saves time and money when making scalar measurements. Frequently performed measurements may be saved for future use on the computer flexible disk. Call up the test later and the system is programmed for your frequency limits, measurement channels . . . everything you need to perform and display the measurement. Calibration data may also be saved for future use. The System Software removes many of the human errors and insures repeatability through consistent calibration and precise measurement techniques.

Easy-to-Use

In either manual or automatic operation, the 8756S is easy to operate. Its fully annotated CRT display is the control center for your measurements. Frequency, power, and scaling parameters are all shown on the 8756A CRT. Most manual measurements can be performed using only 5 keys for each of the two independent channels.

The system software makes the 8756S even easier to use in automatic applications with descriptive menus, simple soft-key operation and lots of "help" information.

Versatile User Graphics

Program your specification limit lines and test against them in real time. Test boundary lines appear on the CRT with your data trace to simplify pass/fail testing. Final plots and tables may be produced with limit lines and flags for out-of-spec data points.

Flexible Plot and Print Formats

Print or plot your data and CRT graphics in your choice of formats without a single line of programming. Select automatic scaling for either the vertical or horizontal axis (or both). Plot with or without labels, grid lines, limit lines, or out-of-spec indicators. Plot up to 4 plots on a single page or print the data in the format you find most useful.

High Performance

Each component of the 8756S is a high performance instrument in its own right. Together, they form a very high performance Automatic Scalar Network Analyzer.

The 8756A Scalar Network Analyzer has 60 dB of calibrated dynamic range (+10 to -50 dBm) in all three output channels (A, B, and R). It uses an AC modulation/detection system for improved performance when measuring signals that are in the presence of unmodulated noise. Detector adapters (HP 11664C) are available that can be used with waveguide detectors for measurements at millimeter-wave frequencies.

The 8756A is fast. With a single command the 8756A sends 401 points of accurate, full resolution (0.01 dB) measurement data to the computer in only 35 milliseconds.

Test signals are provided by the HP 8350B or 8340A high performance sweep oscillators. While either sweeper is fully programmable via HP-IB, they are also extremely easy to use from the front panel. For example, frequencies may be entered by a knob, through the keyboard, or by increment and decrement keys. Up to nine independent front panel settings may be saved or recalled at the touch of a key, or through HP-IB, to help speed your measurements.

NETWORK ANALYZERS

Scalar Network Analyzer, 10 MHz to 40 GHz

Model 8756A



- Simple 5 key operation
- "Autoscale" for fast measurements
- Full HP-IB programmability

- Full annotated digital display
- Nine "Save/Recall" registers
- Direct digital plot capability

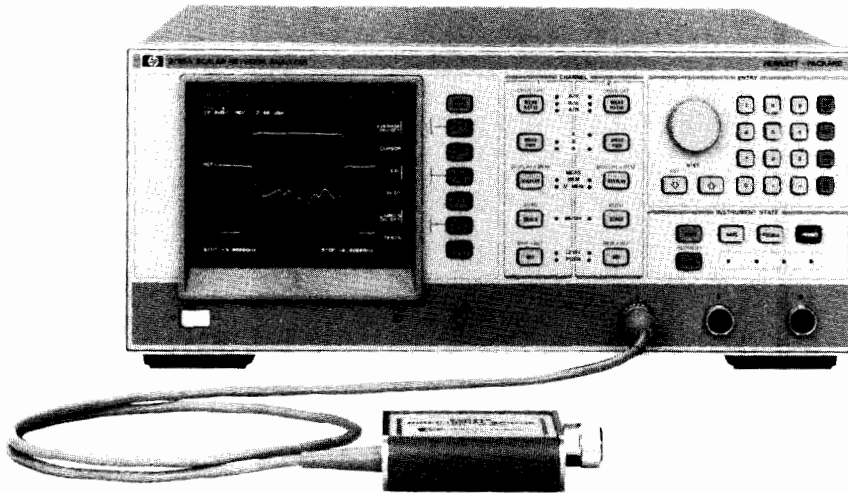

Description

Measure insertion loss and gain, return loss, and absolute power quickly and accurately with the new 8756A Scalar Network Analyzer. These scalar measurements can be performed over a broad 10 MHz to 40 GHz frequency range. Schottky diode detection and AC modulation make accurate, reliable, and drift-free measurements. New high-directivity Directional Bridges covering RF and microwave frequencies produce excellent measurements. The 8756A plus the precise bridges and companion HP swept sources comprise a measurement system with superb performance.

Easy-to-Use

The 8756A features two independent display channels with separate controls. Most measurements can be performed using only five keys for each channel. With four of them, you can set the reference level and offset, set the scale, and select the measurement. The fifth key allows you to store the frequency response of the test system and subtract it from your measured data, providing a normalized measurement. The 8756A always stores data to the full resolution of the instrument (better than 0.01 dB/div), independent of the scale selected.

Make even faster measurements with one key—the "Autoscale" key. Press it and the built-in microprocessor chooses the optimum scale and reference level to display your measurement. With Autoscale, new measurements are displayed instantly, eliminating the need to spend time resetting the controls after changing test devices.

Programmability Features

Since all of the controls of the 8756A are completely programmable, computer-controlled automatic systems can make full use of the 8756A and its built-in features. Measured data can be taken from the 8756A in two ways: the traditional method of point-by-point at CW frequencies, or by Trace Transfer. Using Trace Transfer, the 8756A can transfer a complete 400-point measurement within milliseconds over the Hewlett-Packard Interface Bus (HP-IB). In either case, measurements are transferred with 0.01 dB resolution, regardless of front panel settings.

Precision Annotated Display

The digital display of the 8756A serves as the "control center" for your measurements. In addition to the measured data, all of the pertinent information that describes the measurement is displayed. Reference levels, input selections, and the magnitude of the measured loss (or gain) are listed on the CRT display. Frequency information is also displayed when using the HP 8350B or 8340A sweeper.

The 8756A Display Cursor gives you access to your measurement data. Dial it to any point on the measurement trace, then instantly read the magnitude value (and frequency with the 8350B/8340A) at that point.

Soft Keys add powerful capabilities to the 8756A without creating front-panel clutter. The function performed by each of the six Soft Keys is labeled on the CRT display next to the key. Some of the Soft Keys, when pressed, provide access to even more functions.

For Automatic or Manual Systems

When used with the HP 8350B Sweep Oscillator or 8340A Synthesized Sweeper, the 8756A acts as a system controller by managing the other instruments through the "8756 System Interface." Using the system interface, the 8756A extracts frequency information from the sweeper and uses it to annotate the digital display.

When used alone, the 8756A can save and recall up to nine front-panel states. With the 8350B or 8340A, it saves and recalls not only its own front-panel state, but the sweeper's as well.

Another benefit of the 8756A/8350B combination is "Alternate Sweep"; the ability to sweep two different frequency ranges or power levels and display them simultaneously.

System control also extends to an HP-IB digital plotter. The 8756A can directly plot the CRT's image onto a plotter such as the 9872C or 7470A. Crisp, permanent, annotated plots can be created just by selecting the Plot soft key.

Millimeter Wave Measurements

Using an 8350B sweeper and 83572A/B plug-in (26.5 to 40 GHz), the 8756A brings all of its power and flexibility to millimeter wave measurements. For transmission measurements, use the R422A Waveguide Detector (26.5 to 40 GHz) and the 11664C Detector Adapter. For reflection measurements, add the R752C Waveguide Directional Coupler. Even higher frequencies can be accommodated with the 11664C Detector Adapter and other waveguide detectors.

NETWORK ANALYZERS

8756 System Components

Models 8756A, 85021A/B/C, 85020A/B

8756A Specifications

Amplitude Accuracy

Dynamic range: +10 dBm to -50 dBm in all three inputs (A, B, and R).

Dynamic accuracy: dynamic accuracy of a single channel measurement using 11664A/B Detector. Measurement taken over +10 to -50 dBm at 25°C and at 50 MHz.

± (0.1 dB + 0.01 dB/DB) from +10 to -40 dBm.

± (0.2 dB + 0.02 dB/DB) from -40 to -50 dBm.

Scale resolution: 0.1, 0.2, 0.5, 1, 2, 5, 10, or 20 dB per division. Independently controlled for each measurement channel.

Reference offset: offset level adjustable in 0.01 dB increments from -70.00 to +20.00 dBm (absolute) or -90.00 to -90.00 dB (ratio).

Display Characteristics

Resolution

Vertical: 0.006 dB for display.
0.01 dB for "Display Cursor."

Horizontal: 401 points.

Sweep time: minimum sweep time ≥ 150 ms.

Averaging: 2, 4, 8, 16, 32, 64, 128, or 256 traces may be averaged. Independent control of each display channel.

Normalization: traces are stored and normalized to 0.006 dB resolution, independent of scale/division or offset. The horizontal resolution is 401 points.

HP-IB Characteristics

Transfer formats: data may be transferred as either ASCII strings (nominally 6 characters per reading) or as 16 bit integers. Readings may be taken at a single point or as an entire 401 point measurement trace.

Transfer Speed

ASCII format, trace: 800 ms typical.

ASCII format, point: 10 ms typical.

Binary format, trace: 35 ms typical.

Binary format, point: 5 ms typical.

System Interface

Description: the 8756A System Interface is an HP-IB port used exclusively by the 8756A to control and extract information from a sweep oscillator and a digital plotter.

Sweep oscillators: 8350B with RF plug-in or 8340A

Plotters: 7470A Opt. 002 or 9872C

General Specifications

Power requirements: 48 to 62 Hz, 115/230V ± 10%, typically 100 watts.

Dimensions: 188 H x 425.5 W x 451 mm D (7.4 x 16.75 x 17.75 in.).

Weight: Net, 15 kg (33 lb). Shipping, 20 kg (44 lb).



85021A

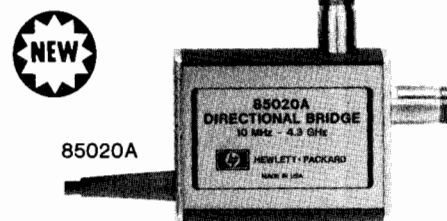

85020A

• 40 dB Directivity

Directional Bridges

The 85020A/B and 85021A/B/C are Directional Bridges designed especially for the 8756A and 8755C Scalar Network Analyzers. Each bridge features outstanding directivity and test port match in a compact, rugged package.

Within each bridge, one zero-bias Schottky diode detector measures the return loss of the test device. Ratio measurements can be made by adding a power splitter (11667A) and detector (11664A/B).

85021A/B/C Directional Bridges

The three new microwave Directional Bridges cover the 10 MHz to 26.5 GHz frequency range. Accurately measure SMA devices over the full 10 MHz to 26.5 GHz frequency range with the 85021B Bridge with its precise APC 3.5 test port connector. For 10 MHz to 18 GHz reflection measurements choose the 85021C with its Type-N test port connector or the rugged APC-7® test port connector of the 85021A.

85021A/B/C Specifications

Frequency Range

85021A: 0.01 to 18 GHz.

85021B: 0.01 to 26.5 GHz.

85021C: 0.01 to 18 GHz.

Nominal impedance: 50 ohms.

Input Connector

- 85021A:** Type-N Female.
- 85021B:** APC-3.5 Female.
- 85021C:** Type-N Female.

Output Connector

- 85021A:** APC-7.
- 85021B:** APC-3.5 Female.
- 85021C:** Type-N Female.

Maximum power to input port: +23 dBm.

Directivity

- 85021A:** 0.01 to 0.04 GHz: 36 dB.
0.04 to 18 GHz: 40 dB.
- 85021B:** 0.01 to 0.04 GHz: 36 dB.
0.04 to 20 GHz: 40 dB.
20 to 26.5 GHz: 36 dB.
- 85021C:** 0.01 to 12.4 GHz: 36 dB.
12.4 to 18 GHz: 34 dB.

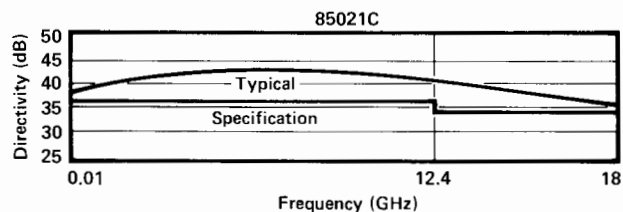
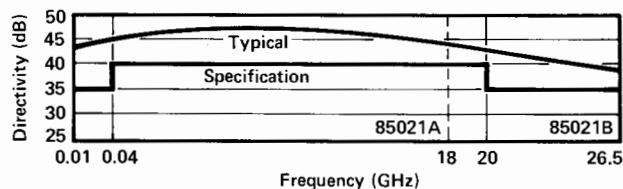

Test Port Match (SWR)

- 85021A/C:** 0.01 to 8.4 GHz: 1.15.
8.4 to 12.4 GHz: 1.25.
12.4 to 18 GHz: 1.40.
- 85021B:** 0.01 to 8.4 GHz: 1.15.
8.4 to 20 GHz: 1.40.
20 to 26.5 GHz: 1.75.

Typical Input Port Match (SWR)

- 85021A/C:** 0.01 to 8.4 GHz: <1.22.
8.4 to 18 GHz: <1.43.
- 85021B:** 0.01 to 8.4 GHz: <1.22.
8.4 to 20 GHz: <1.43.
20 to 26.5 GHz: <1.93.

Typical Insertion Loss

- 85021A/B/C:** 6.5 dB at 10 MHz.
8.0 dB at 18 GHz.
- 85021B:** 10 dB at 26.5 GHz.

Typical detector flatness: +3, -1 dB (with leveled RF).

Typical minimum input power (for a 40 dB return loss measurement): +7 dBm at 18 GHz.

Dimensions: 15 H x 110 W x 96 mm D (1.0 x 4.3 x 3.9 in).

Weight: net, 0.5 kg (1.2 lb). Shipping, 2.3 kg (5 lb).

85020A/B Directional Bridges

The economical 85020A/B Directional Bridges also offer high (40 dB) directivity and excellent port match at RF (to 4.3 GHz) frequencies. For 50 ohm measurements choose the 85020A. The 85020B is designed for 75 ohm environments. Both RF bridges have Type-N connectors.

85020A/B Specifications

Frequency Range

- 85020A:** 0.01 to 4.3 GHz.
- 85020B:** 0.01 to 2.4 GHz.

Nominal Impedance

- 85020A:** 50 ohms.
- 85020B:** 75 ohms.

Connectors: Type-N Female.

Maximum power to input port: +23 dBm.

Directivity

- 85020A:** 0.01 to 3 GHz: 40 dB.
3 to 4.3 GHz: 34 dB.
- 85020B:** 0.01 to 2.4 GHz: 40 dB.

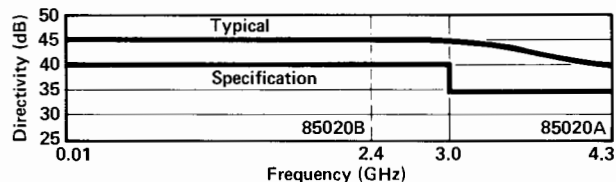

Test Port Match (SWR)

- 85020A:** 0.01 to 3 GHz: 1.20.
3 to 4.3 GHz: 1.25.
- 85020B:** 0.01 to 1.3 GHz: 1.25.
1.3 to 2.4 GHz: 1.39.

Typical Input Port Match (SWR)

- 85020A:** 0.01 to 4.3 GHz: 1.25.
- 85020B:** 0.01 to 2.4 GHz: 1.25.

Typical insertion loss: 6.5 dB.

Typical detector flatness: ±0.5 dB.

Typical minimum input power (for a 40 dB return loss measurement): +4 dBm.

Dimensions: 25 H x 110 W x 96 mm D (1.0 x 4.3 x 3.9 in).

Weight: net, 0.5 kg (1.2 lb). Shipping, 2.3 kg (5 lb).

NETWORK ANALYZERS

8756 System Accessories

Models 11666A, 11664A/B, 85023A, 85022A, 85015A, 11668A, 11678A

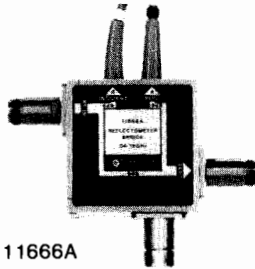

11666A

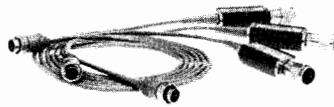

11664A

11666A Reflectometer Bridge

Reflection measurements covering from 40 MHz to 18 GHz with one directional device can be made with the Model 11666A Reflectometer Bridge. Operation of this type of directional device is based on principles of the resistive Wheatstone Bridge extended to microwave frequencies. When three bridge arms are 50Ω, the voltage across corners of the bridge is directly proportional to the reflection coefficient of the device connected in the fourth arm. Equivalent directivity is then a measure of how well the bridge circuit is balanced with a 50Ω termination connected. (Ideally this would create a voltage null representing infinite return loss.) The high equivalent directivity achievable over wide bandwidths makes the bridge configuration attractive.

Two Schottky diode detectors (which sample the incident and reflected signals for ratioing by the 8755) are incorporated as an integral part of the bridge unit. The effective external leveling achieved by ratioing thus isolates the measurement port from source/bridge input mismatch. With the addition of an external 11664A Detector, two simultaneous ratio measurements of insertion and return loss can be made.

Specifications 11666A (connected to the 8756A or 8755C Scalar Network Analyzer)

Frequency range: 40 MHz to 18 GHz.

Frequency Range	Equivalent Directivity	Equivalent Output SWR
40 to 100 MHz	30 dB	1.25
0.1 to 1 GHz	38 dB	1.25
1 to 2 GHz	36 dB	1.25
2 to 4 GHz	33 dB	1.25
4 to 8 GHz	29 dB	1.25
8 to 12 GHz	27 dB	1.27
12 to 18 GHz	26 dB	1.52

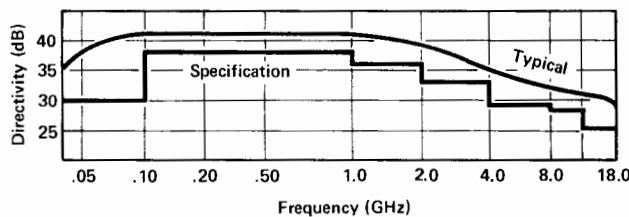

Frequency Tracking

(between incident and reflected arms): < 3.2dB
 (between incident and test port, including 1.1 dB from 11664A Detector): < 4.3dB

Nominal coupling: 6-dB incident arm. 9-dB reflected arm. 9-dB transmission loss.

Input SWR: 1.92.

Maximum input power: +15 dBm.

Connectors: type N-Female on input and output. APC-7 Optional. **Size:** 69.9 mm H x 69.9 mm W x 46.4 mm D (2³/₄" x 2³/₄" x 1²⁷/₃₂"). Cable length, 1219 mm (48").

Weight: net, 0.7 kg (1.5 lb). Shipping, 2.26 kg (5.13 lb).

Accessories furnished: 11512A Short, Type N-Male (11565A short, APC-7 with Opt 002).

11664A Detectors

Function: designed specifically for use with the 8756A and 8755C Scalar Network Analyzer, the 11664A detects the envelope of the 27.8 kHz modulated microwave signal. It uses a biased Schottky diode to achieve -50 dBm sensitivity.

Frequency range: 10 MHz to 26.5 GHz.

Tracking between Two 11664A Detectors

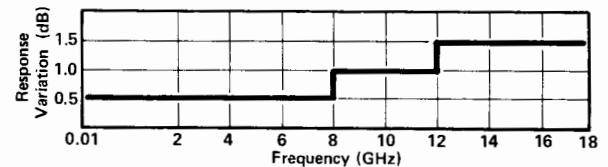

Typical Frequency Response

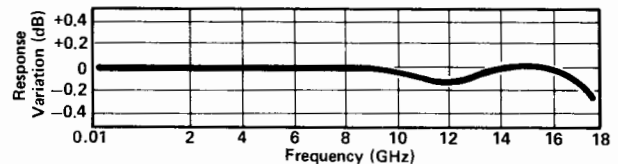

Return Loss

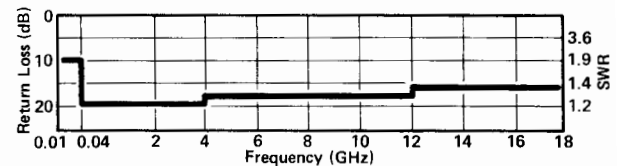

Impedance: 50 ohms nominal

Connector: N-Male.

11664B Detectors

(All specifications are the same as the 11664A with the following differences):

Frequency range: 10 MHz to 26.5 GHz.

Tracking between two 11664B Detectors: tracking between two detectors at the same power level is typically < 2 dB from 10 MHz to 26.5 GHz.

Return Loss:

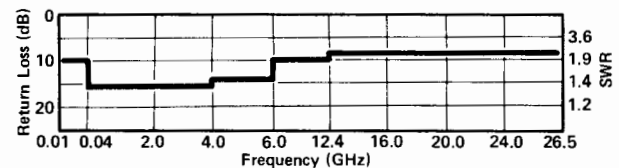

Connector: APC 3.5 Male.



85023C

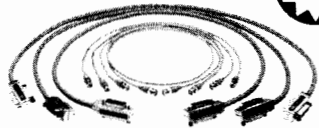

85022A

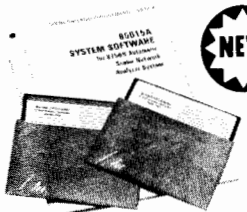

85015A



11678A



11668A

85023A/B/C/D Verification Kits

The 85023A/B/C/D System Verification Kits each contain a set of precision components used to perform a system verification procedure for the 8756S Scalar Network Analyzer System. This procedure, which is in the 8756A Operating and Service Manual, checks system installation and can be used as a daily functional test.

Choose a system Verification Kit to match your device under test. For APC-7 applications, select the 85023A. If you are measuring SMA or APC-3.5 devices, choose the 85023B. For 50 ohm, Type-N applications, select the 85023C. These kits (85023A/B/C) all include an open, short, 10 dB fixed attenuator, 50 ohm termination, and a source to directional bridge adapter of the corresponding connector type. The 85023D Verification Kit, for 75 ohm Type-N measurements, consists of a short, a 75 ohm termination, a 50 ohm 10 dB fixed attenuator and two 11852A 50 to 75 ohm Minimum Loss Pads (for 50/75 ohm impedance conversion).

Frequency range: 85023A/C, dc to 18 GHz.

85023D, dc to 1.3 GHz.

85023B, dc to 26.5 GHz.

Connector type: 85023A, APC-7.

85023B, APC-3.5.

85023C, Type-N, 50 ohm.

85023D, Type-N, 75 ohm.

Characteristic impedance: 85023A/B/C, 50 ohm.

85023D, 75 ohm.

Weight: net 0.5 kg (1.2 lb). Shipping 1.2 kg (2.9 lb).

85022A System Cable Kit

The 85022A contains all the BNC and HP-IB cables to connect an 8350B Sweep Oscillator (or 8340A Synthesized Sweeper), a series 200 computer, and a printer to the 8756A. This kit contains 3 one meter HP-IB cables (HP 10833A), 3 two foot BNC cables (HP 11170B), and 1 four foot BNC cable (HP 11170C).

BNC connectors: N-Male, N-Male.

BNC impedance: 50 ohm.

Weight: net 0.5 kg (1.2 lb). Shipping 1.2 kg (2.9 lb).

85015A System Software for 8756S

Save frequently performed measurement procedures and calibration data for future use. Measure insertion loss, gain, power and reflection coefficient. The 85015A allows you to customize your test sequence and then print or plot the output in your choice of formats. The 85015A includes two system disks and a data disk for either 5.25 inch or 3.5 inch disk drives. Choose the option that corresponds to your computer configuration.

Weight: net 0.5 kg (1.2 lb). Shipping 1.2 kg (2.9 lb).

11668A High Pass Filter

The 11668A High Pass Filter accessory is recommended when making measurements on active devices that have gain below 50 MHz. Use of the 11668A, placed after the 11665B, reduces the modulator drive feedthrough from 8 mV to 1 mV and prevents possible amplifier saturation. Use of the 11668A filter is not necessary for passive measurements since the feedthrough from the 11665B is -65 dBm and causes no degradation in system performance.

Frequency range: 50 MHz to 18 GHz.

	Insertion Loss	Return Loss
50-100 MHz	≤2.5 dB	≥12 dB
100 MHz-8 GHz	≤1.0 dB	≥16 dB
8-12 GHz	≤1.0 dB	≥14 dB
12-18 GHz	≤1.5 dB	≥14 dB

Maximum input: +27 dBm.

Connectors: N-female, N-male

Weight: 0.13 kg (5 oz). Shipping 0.28 kg (10 oz).

11678A Low Pass Filter Kit

Description: the 11678A Low Pass Filter Kit contains five filters. Low pass filters reduce harmonics generated by the RF source when making precision measurements.

Frequency Range (low pass filters, cutoff frequency f_c)

11668A: 2.8 GHz.

11689A: 4.4 GHz.

11684A: 6.8 GHz.

11685A: 9.5 GHz.

11686A: 13.0 GHz.

Insertion loss: <1.1 dB at 0.95 f_c .

Rejection (at 1.25 f_c): Greater than 40 dB.

Impedance: 50 ohm normal.

Connectors: N-Female, N-Male.

Weight: net, 0.44 kg (1 lb). Shipping, 1.2 kg (2.9 lb).

Service Products

8756+23N Onsite Installation (where available)

Be sure your 8756S Automatic Scalar Network Analyzer System is operating from the start by having an HP Customer Engineer configure your system at your site. After you have unpacked the equipment the HP Customer Engineer will assemble and verify the operation of your system.

8756S+232B Onsite Service (where available)

Increase your total system uptime by ordering onsite service. An HP Customer Engineer will come to your site to perform all repairs for one year.

NETWORK ANALYZERS

8756 System Accessories (cont.)

Models 11667A, 11665B, 11664C, 11679A/B, 11852A

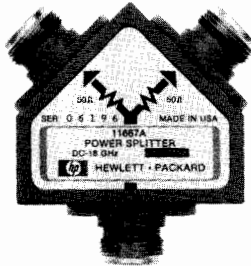

11667A



11665B



11664C

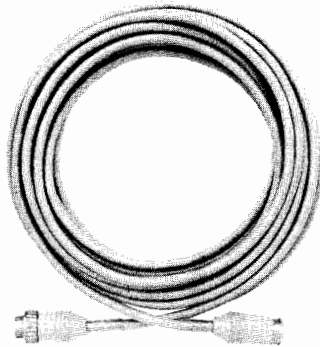

11679A

11667A Power Splitter

The 11667A Power Splitter is recommended when making wide-band ratio measurements using the 8756A or 8755C Scalar Network Analyzer. This two-resistor type splitter provides excellent output SWR at the auxiliary arm when used for source leveling or ratio measurement applications. The 0.25 dB tracking between output arms over a frequency range from dc to 18 GHz allows wideband measurements to be made with a minimum of uncertainty.

Frequency range: dc to 18 GHz.

Impedance: 50Ω.

	dc-4 GHz	dc-8 GHz	dc-18 GHz
Input SWR:	≤1.15	≤1.25	≤1.45
Equivalent output SWR:	1.10	1.20	1.33
leveling or ratio			
Output tracking: (between output arms)	<0.15 dB	<0.20 dB	<0.25 dB

Insertion loss: 6 dB nominal (input to either output).

Maximum input power: +27 dBm (0.5 watt).

Connectors: Type N female on all ports.

Size: 46 H x 50 W x 19 mm D (1¹³/₁₆" x 2" x 3/4").

Weight: net, 0.06 kg (2 oz). Shipping 0.22 kg (8 oz).

Other Signal Separation Devices

Many other signal separation devices are available from HP for use with the 8756A and 8755C. Coaxial couplers from 0.1 to 18 GHz are available with the 770 series, the 790 series, and the 11692. Higher directivity 752 series waveguide couplers can also be used with the 8756A or 8755C with the addition of appropriate 281 series waveguide to coax adaptors.

11665B Modulator

Function: absorptive on-off modulator designed for and powered by the 8756A or 8755C Scalar Network Analyzers.

Frequency Range	Return Loss On and Off	Insertion Loss On Off
15-40 MHz	≥10 dB	≤7.0 dB ≥35 dB
40 MHz-4 GHz	≥15 dB	≤3.2 dB ≥35 dB
4-8 GHz	≥12 dB	≤3.8 dB ≥40 dB
8-12.4 GHz	≥8 dB	≤4.3 dB ≥45 dB
12.4-18 GHz	≥8 dB	≤5.0 dB ≥45 dB

Modulator drive feedthrough: ≤8 mV (peak) at 27.8 kHz at either port when powered by the 8756A or 8755C. Reduced to ≤1 mV (peak) using the 11668A. (See 11668A High Pass Filter).

Drive current: nominally +50 mA in ON condition, -50 mA Off condition.

Weight: net 0.17 kg (6 oz). Shipping, 0.9 kg (2 lb).

11664C Detector Adapter

The 11664C Detector Adapter is used to adapt any standard diode detector output (low barrier Schottky or point contact crystal, positive or negative bias) with the 8756A or 8755C Scalar Network Analyzer. You can extend the frequency range of the scalar network analyzer to that of the diode detector used. For example, the HP R422A Waveguide Crystal Detector with the 11664C Detector Adapter allows the 8756A or 8755C Scalar Network Analyzer to make transmission and reflection measurements over the 26.5 to 40 GHz frequency range. Two adjustments allow you to accurately match the diode detector to the scalar network analyzer.

Connector: BNC Male.

Dimensions: cable Length 1.22 m (48 in).

Weight: net 0.17 kg (0.4 lb). Shipping 0.9 kg (2 lb).

11679A/B Extension Cables

For applications where it is inconvenient to have the network analyzer near the test device, the 11679A 25 foot Extension Cable and 11679B 200 foot Extension Cable fits directly between 11664A Detector and display. Remote detector operation is permitted without performance degradation.

11852A 50 ohm / 75 ohm Minimum Loss Pad

The 11852A is a low SWR minimum loss pad required between 75 ohm devices and 50 ohm sources and detectors. For more information see page 453.



Ordering Information

The 8756S Automatic Scalar Network Analyzer is ordered with multiple line items to give you maximum flexibility in specifying a system that meets your needs. This ordering guide lists the 8756S line items required for software compatibility. It is not necessary to order any line item you already own. Consult your local HP Sales Office if you would like assistance.

8756S Scalar Network Analyzer System

This system model number insures coordination of shipments and compatibility of instruments and software.

Analyzer

8756A Scalar Network Analyzer

Sweep Oscillators (choose either 8350B with an RF Plug-in or 8340A)

8350B Sweep Oscillator Mainframe

83522A 0.01–2.4 GHz RF Plug-in

83592A 0.01–20 GHz RF Plug-in

83595A 0.01–26.5 GHz RF Plug-in

Other RF Plug-in (see 8350B catalog entry for model and options)

8340A 0.01–26.5 GHz Synthesized Sweeper

Directional Bridges (choose at least one)

85021A 0.01–18 GHz, APC-7, 50 ohm

85021B 0.01–26.5 GHz, APC-3.5 female, 50 ohm

85021C 0.01–18 GHz, Type-N female, 50 ohm

85020A 0.01–4.3 GHz, Type-N female, 50 ohm

85020B 0.01–2.4 GHz, Type-N female, 75 ohm

Detectors (choose at least one)

11664A 0.01–18 GHz, Type-N male

11664A Opt. 001 0.01–18 GHz, APC-7

11664B 0.01–26.5 GHz, APC-3.5 male

System Verification Kits (choose at least one)

85023A APC-7, 50 ohm

85023B APC-3.5, 50 ohm

85023C Type-N, 50 ohm

85023D Type-N, 75 ohm

System Cable Kit

85022A System Cable Kit

Computer (choose one)

9816S Series 200, Model 16S Computer (select option)

Opt. 630 for use with 9121D Disk Drive

Opt. 650 for use with 82901M Disk Drive

9826S Series 200, Model 26S Computer

9836S Series 200, Model 36S Computer

98256A 256K byte Memory Board (required for all computers)

Disk Drives (one required for 9816S)

9121D 3.5 inch Dual Flexible Disk Drive

82901M 5.25 inch Dual Flexible Disk Drive

Software (choose one option)

85015A System Software for 8756S

Opt. 630 for 9816S Computer with 9121D Disk Drive

Opt. 650 for 9816S Computer with 82901M Disk Drive

Opt. 655 for either 9826S or 9836S Computer

Printer (choose at least one)

2673A Thermal Graphics Printer

2932A Impact Graphics Printer

Recommended Accessories

Plotters (choose at least one)

7470A Opt. 002 Two-pen Graphics Plotter (8.5" x 11")

9872C Eight-pen Vector Plotter (11" x 17")

Optional Accessories (for ratio and/or modulation measurements)

11665B Modulator

11667A Power Splitter

11852A 50 to 75 ohm Minimum Loss Pad

Service and Support Products

8756S+23N Onsite Installation (where available)

8756S+23B Onsite Service (where available)

Compatible 8350B Plug-ins

All of the following 8350B RF Plug-ins are compatible with 85015A System Software:

83522A RF Plug-in (0.01–2.4 GHz)

83525A/B RF Plug-ins (0.01–8.4 GHz)

83540A/B RF Plug-ins (2.0–8.4 GHz)

83545A RF Plug-in (5.9–12.4 GHz)

83570A RF Plug-in (18–26.5 GHz)

83572A/B RF Plug-ins (26.5–40 GHz)

83590A RF Plug-in (2.0–20 GHz)

83592A/B/C RF Plug-in (0.01–20 GHz)

83594A RF Plug-in (2.0–26.5 GHz)

83595A RF Plug-in (0.01–26.5 GHz)

11869A RF Plug-in Adapter (to 8350B) required for the following 86200 series plug-ins:

*86220A RF Plug-in (0.01–1.3 GHz)

86222A/B RF Plug-ins (0.01–2.4 GHz)

*86230B RF Plug-in (1.8–4.2 GHz)

86235A RF Plug-in (1.7–4.3 GHz)

86240A/B RF Plug-ins (2.0–8.4 GHz)

*86240C RF Plug-in (3.6–8.6 GHz)

*86241A RF Plug-in (3.2–6.5 GHz)

86242D RF Plug-in (5.9–9.0 GHz)

86245A RF Plug-in (5.9–12.4 GHz)

86250D RF Plug-in (8.0–12.4 GHz)

86251A RF Plug-in (7.5–18.6 GHz)

*86260A RF Plug-in (12.4–18.0 GHz)

*86260B RF Plug-in (10.0–15.5 GHz)

*86260C RF Plug-in (17.0–22.0 GHz)

86290A RF Plug-in (2.0–18.0 GHz)

86290B/C RF Plug-ins (2.0–18.6 GHz)

*Requires 11865B Modulator



NETWORK ANALYZERS

Scalar Network Analyzer System, 10 MHz to 26.5 GHz

Model 8755S

- 10 MHz to 26.5 GHz frequency range
- Absolute & ratio measurement capability
- Complete complement of measurement accessories
- Economical scalar measurement system
- 60 dB dynamic measuring range for each detector
- Free of interference from stray fields or unwanted signals

8750A Storage-Normalizer

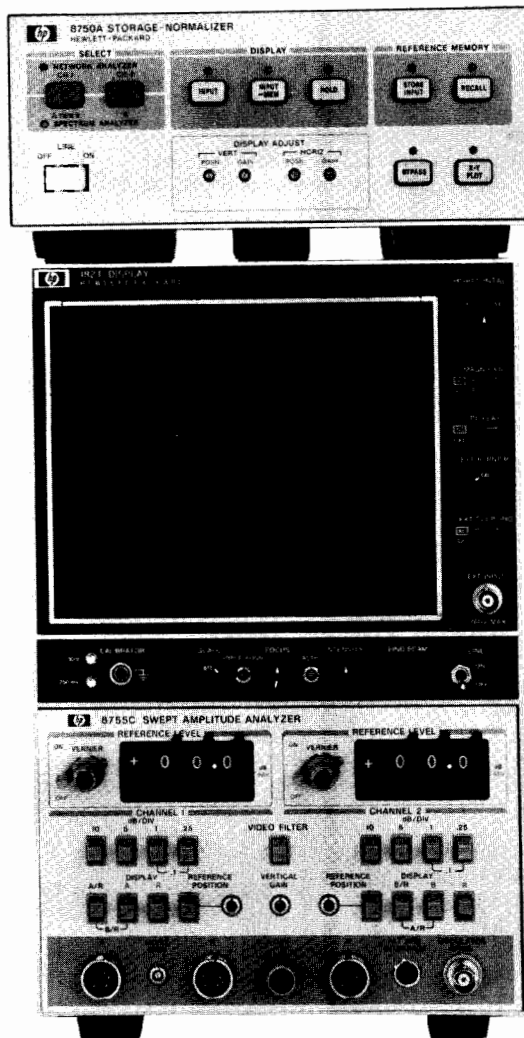

182T Display / 8755C Plug-in
11664A Detectors

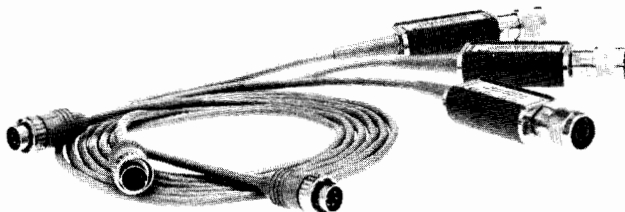

8755S SYSTEM

8755S Frequency Response Test System

The 8755S is an economy network measurement system designed to make absolute power and ratio measurements over the 10 MHz to 26.5 GHz frequency range. It is a versatile system for scalar (amplitude only) impedance and transmission measurements. The 8755S system consists of the following separate instruments: (1) 8755C Swept Amplitude Analyzer, (1) 182T display unit, (1) 8750A Storage Normalizer, and (3) 11664A Schottky diode detectors.

The 8755C has two independent channels and three detector inputs allowing simultaneous ratio measurement capability. All three detectors have a +10 dBm to -50 dBm dynamic range, are interchangeable, and require no calibration. For each channel a resolution of 10, 5, 1, 0.25 or 0.1 dB per division is available (also combinations of these, e.g., 15 dB/division) as well as a calibrated offset of ± 59.9 dB in 0.1 dB increments. The 8750A Storage-Normalizer connects directly to the 8755/182T by a single cable to provide digital normalization and storage capability for both channels.

Common measurements made with the 8755 are simultaneous insertion and return loss, amplifier gain and gain compression, and mixer conversion loss and return loss, all on a swept frequency basis. The 8755S system has many features that improve both the accuracy and the versatility compared with other scalar measurement systems.

The 8755S can interface with sources having alternate sweep capability, such as the 8350 Sweep Oscillator, allowing two independent frequency and power ranges to be displayed on consecutive sweeps. With this powerful capability, measurements of amplifier compression and filter pass/stop band response become simple manual measurements. For added flexibility in this mode, the 8755C allows full channel independence of scale per division and offset.

The 8755C uses an ac detection system which can reject undesired RF signals such as local oscillator feedthrough in mixer measurements, external traffic in antenna measurements, and broadband noise in amplifier measurements. The 8755C provides the 27.8 kHz squarewave drive to AM modulate the RF sweeper output either directly (most HP 8620 and all 8350 RF sweeper plug-ins are directly compatible with the 8755) or by using the 11665B External Modulator.

In addition to making absolute or relative power measurements with a single detector, the 8755 will also measure the logarithmic difference in power between two detectors, i.e., ratio measurements. Ratio measurement techniques improve accuracy by providing better equivalent source match and immunity to source power variations. A ratio technique can also allow dynamic range expansion up to 100 dB.

The 8750A Storage-Normalizer improves both the accuracy and convenience of swept frequency measurements. System frequency response error is eliminated by subtracting a digitally stored calibration trace from the measurement trace using the 8750 input minus memory mode. The input minus memory mode also facilitates comparison measurements by providing a single trace display of the difference between two devices. The 8750A has digital storage for flicker-free displays so that a complete trace is seen independently of the RF sweep rate. This is a real benefit when device constraints require a slow sweep rate as when making narrow band filter measurements. The 8750A also makes x-y plotting much more convenient by automatically outputting the x, y and penlift signals from digital memory at the push of a single button.

A number of accessories are available for use with the 8755S system to meet most signal separation and filtering requirements. These include the HP 85020, 85021 and 11666 Bridges, HP 11664 Detectors and other accessories described on pages 432 through 436.

NETWORK ANALYZERS

8755 System Components

Models 8755C, and 8750A

439

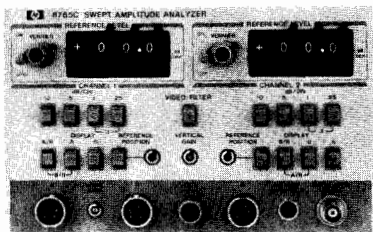

8755C

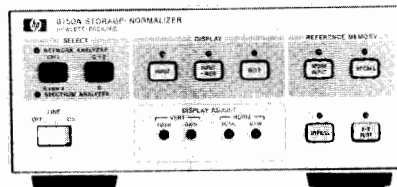

8750A

Individual Instrument Specifications

8755C Plug-In

Function: the 8755C plug-in processes demodulated 27.8 kHz signals from the 11664 Detectors (R,A,B) for logarithmic display on 180 series oscilloscopes.

Resolution: independent for each channel in steps of 10, 5, 1, 0.25, or 0.1 dB per division.

Offset: independent for each channel. ± 59.9 dB in 0.1 dB increments.

Display Units

180 "T" series displays are recommended for use with the 8755C. They provide zero offset recorder outputs, and both positive and negative 5-volt retrace blanking inputs.

Large screen (model 182T): this display unit is contained in the 8755S standard configuration. It has an 8 \times 10 division internal graticule with 1 div=1.29 cm. and medium persistence P39 phosphor.

Rack mount (model 180TR): this display unit is contained in the 8755S Option 001 system configuration. It has an 8 \times 10 division internal graticule with 1 div = 1 cm. and medium persistence P39 phosphor.

The 182T and 180TR are directly compatible with the 8750A Storage-Normalizer. As a result of the 8750A compatibility, the 182T and 180TR cannot be used with time domain plug-ins.

Variable persistence/storage (model 181T, cabinet model 181TR, rack mount): these displays can be ordered individually for use with the 8755C. Because they offer CRT storage, they have not been made compatible with the 8750A Storage-Normalizer. They have an 8 \times 10 division internal graticule with 1 div = 0.95 cm. and offer variable persistence phosphor for storing single or multiple traces.

8750A Storage-Normalizer

Function: provides digital storage display and digital normalization for both channels of the 8755. The 8750A connects directly to the 8755/182T via a single cable.

Common System Specifications

Power Measurement Range

Single channel: +10 dBm to -50 dBm (noise level).

System Accuracy (ratio measurements)

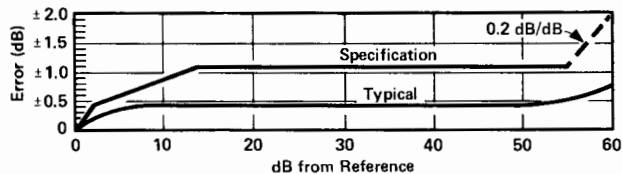

Accuracy curve shows system uncertainty for a relative measurement with +10 dBm incident at the test detector when the 0-dB reference is set. Accuracy when calibration levels below +10 dBm are used remains the same, except the additional 0.2 dB/dB uncertainty should be added for measurements below -45 dBm. This curve includes system noise, offset uncertainty, and crosstalk, and assumes the reference detector power remains fixed between calibration and test. Refer to detector, coupler, or bridge specifications to determine system frequency response.

Absolute Measurements

Absolute power incident on a detector is displayed with respect to the 0 dBm POSITION line when the OFFSET CAL switch is turned OFF. Accuracy at any power level is typically ± 0.5 dB not including detector frequency response or mismatch errors. For applications requiring more precision, increased accuracy can be obtained if the

8755 display is calibrated at a specific power level using a power meter. The stability of the 8755 then permits accurate power measurements repeatable to hundredths of dBs.

Temperature range: operation, 0 to 55°C; storage, -40°C to 75°C.
Power: 48 to 440 Hz, 115/230 V $\pm 10\%$, typically 100 watts.

8755S Specifications

Consists of:

8755C Swept Amplitude Analyzer

182T Display

11664A Detectors (3 each)

8750A Storage-Normalizer

Frequency range: 10 MHz to 18 GHz (determined by the 11664A Detectors)

8755S Option 001 Specifications

Consists of:

8755C Swept Amplitude Analyzer

180TR Display

11664A Detectors (3 each)

8750A Storage-Normalizer

8755S Option 002 Specifications

Consists of:

8755C Swept Amplitude Analyzer

182T Display

11664A Detector (1 each)

11666A Reflectometer Bridge

8750A Storage-Normalizer

Frequency range: 40 MHz to 18 GHz (determined by the 11666A Bridge).

8755S Option 003 Specifications

Adds 11665B External Modulator.

Frequency range: 15 MHz to 18 GHz (determined by the 11665B Modulator).

8755S Option 004 Specifications

Deletes the 8750A Storage-Normalizer.

8755S Option 005 Specifications

Consists of:

8755C Swept Amplitude Analyzer

182T Display

11664B Detectors (3 each)

8750A Storage-Normalizer

Frequency range: 10 MHz to 26.5 GHz (determined by the 11664B Detectors).

Ordering Information

The 8755S system and its options are configured of separate instruments and components solely for ordering convenience. If a different display or optional connectors are desired, each part of the system should be listed separately.

8755S Scalar Network Analyzer System

Opt 001: Rack mount version

Opt 002: deletes (2) 11664 Detectors, adds

11666A Reflectometer Bridge

Opt 003: adds 11665B Modulator

Opt 004: deletes 8750A Storage-Normalizer

Opt 005: Replaces (3) 11664A with (3) 11664B

8755C Test Set Plug-in only

8750A Storage Normalizer

182T Large Screen Cabinet Scope Display

180TR Standard Screen Rack Display

181T Storage, Cabinet Display

181TR Storage, Rack Display

NETWORK ANALYZERS

Network Analysis From 50 Hz to 13 MHz

Model 3040A

- High resolution digital amplitude, phase and group delay measurements
- 100 dB dynamic range
- Synthesizer frequency accuracy and stability
- Precision digital sweep capability
- Narrow band analysis
- Full digital control via HP-IB

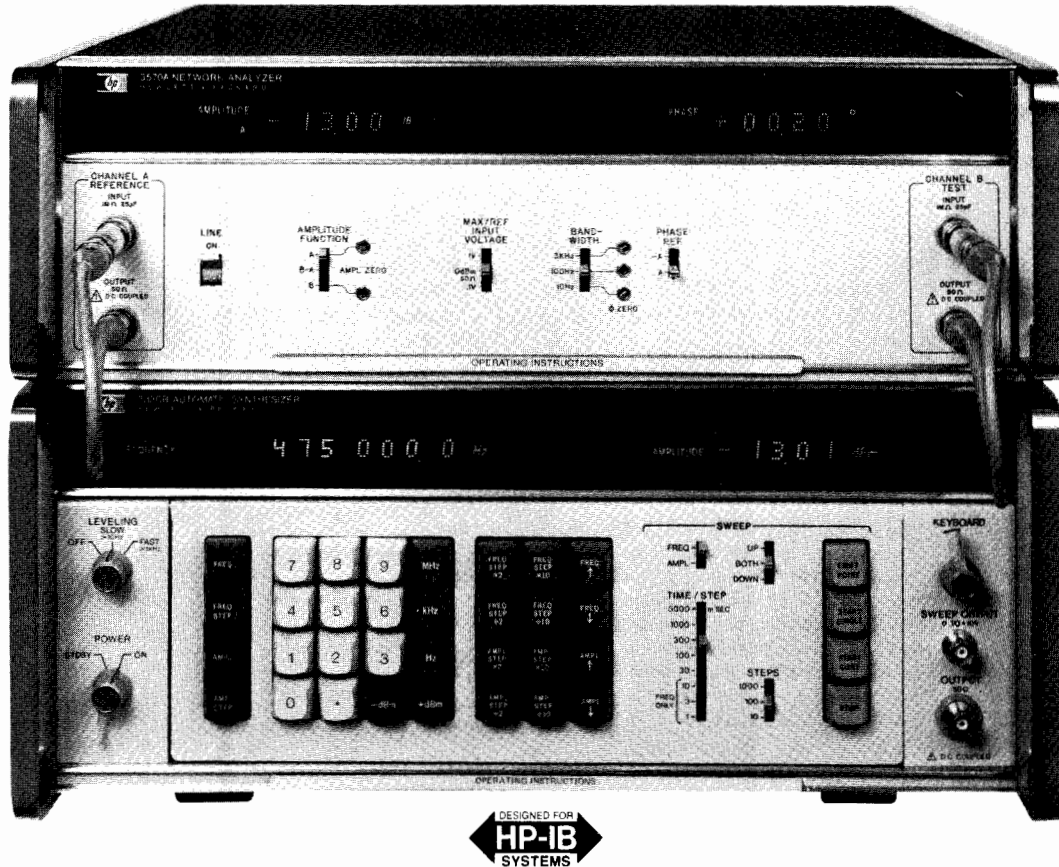

Description

The 3040A Network Analyzer is designed to meet the demand for precise and fast characterization of both active and passive linear two-port devices. The Network Analyzer is a powerful bench system that makes digital amplitude, phase and group delay response measurements over a 50 Hz to 13 MHz frequency range. It uses the 3330B Automatic Synthesizer with leveled output and digital sweep capability to generate the local oscillator signal for the 3570A Tracking Receiver and to provide the stimulus to the device under test.

This system effectively combines the wide dynamic range and the high accuracy of the 3570A Tracking Receiver with the high resolution and stability of the 3330B Synthesizer, giving design, production and Q.A. engineers working at audio, video and RF frequencies the precision, convenience, and high information content of digital swept-frequency response measurements, but with the point by point accuracy of synthesized incremental frequency sweeps.

Residual FM, often a serious limitation to the frequency resolution of swept frequency measurements, is very low ($\ll 1$ Hz) in the 3040A System, allowing accurate narrow band sweeps.

The 3570A Analyzer (Tracking Receiver) has two identical channels for fast, high accuracy "B-A" measurements of gain or insertion loss of two-port devices and to measure the phase shift between input and output ports. It can also function as a limit comparator to determine how closely the gain and phase response of a device matches that of a reference.

Both the passband and the stopband of a device can be examined in detail because the 3570A Analyzer has both a wide amplitude range of 120 dB (1 μ V to 1 V) and a high resolution display (0.01 dB increments). The digital readout also displays phase readings with 0.01° resolution.

Beyond the basic amplitude and phase measurements, the 3040A offers several automatic features not found in more conventional network analyzers.

One is Digital Offset: Values of amplitude and/or phase measured on a reference device are stored in the instrument's memory at the push of a button. Future measurements can then be displayed relative to the stored values. This could be used, for example, to quickly find the -3 dB passband limits of a filter or amplifier.

Another feature is Group Delay: As the synthesizer is stepped in frequency, the analyzer's internal digital processor calculates group delay from two phase shift measurements as $T_d = \Delta\theta/360\Delta f$ sec.

A third one is Limit Test: High and low limits can be entered as digital words from an external controller. The analyzer can be set to stop or output a marker when a limit is reached. This capability is useful, for example, to precisely find the center frequency of a resonant circuit by stopping at the 0° phase reading.

The 3040A Network Analyzer introduces precision, convenience and built-in "intelligence" to the problem of characterizing the behavior of linear networks on the bench.

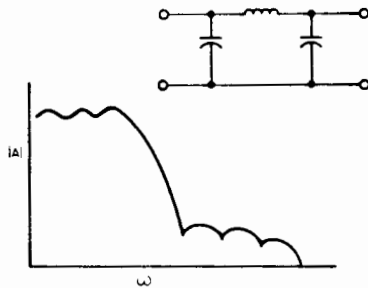

Filter Testing

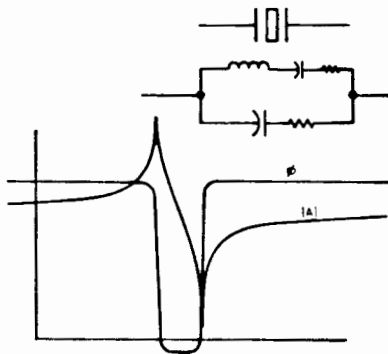

Crystal Testing

Specifications

Sources (channel A & B outputs are isolated and electrically identical)

Frequency

Range: 0.1 to 13,000,999.9 Hz.

Resolution: 0.1 Hz (9 digits).

Amplitude

Range: +13.44 to -86.55 dBm (50 Ω).

+11.68 to -88.31 dBm (75 Ω option).

Resolution: 0.01 dB.

Accuracy

Leveled Frequency Response (10 kHz reference)*

10 Hz	13 MHz	
±0.45 dB		+13.44 dBm
±0.5 dB		-16.55 dBm
±0.6 dB		-36.55 dBm
±0.8 dB		-66.55 dBm
		-86.55 dBm

*Add 0.5 dB for leveling switch in off position.

Attenuator: (10 kHz reference, 25°C ± 5°C) ±0.02 dB/10 dB step of attenuation down from maximum output.

Absolute: (10 kHz, maximum output, 25°C ± 5°C) ±0.45 dB.

Stability: (24 hr., 25°C ± 1°C): ±0.01 dB.

Impedance: 50 or 75 Ω (optional) ±2%.

Receivers (channel A & B inputs are electrically identical and both tuned precisely to the signal source's frequency)

Frequency

Range: 50 Hz to 13 MHz.

Resolution: 0.1 Hz.

Selectivity: 10 Hz, 100 Hz and 3 kHz bandwidths (60 dB/3 dB bandwidths, 20:1).

Amplitude: (output is in dB relative to 1 V, 0 dBm or 0.1 V, corresponding to the position of the "Max/Ref Input Voltage" switch.)

Measurement range: 1 V rms to 1 μV rms.

Dynamic range: 0 to -100 dB (using A or B amplitude function), -100 dB to +100 dB (using B-A amplitude function).

Resolution: 0.01 dB.

Frequency response: A or B "Amplitude Function" ±0.5 dB; B-A "Amplitude Function" ±0.1 dB.

Linearity: (A or B amplitude function)

0 to -20 dB	±0.2 dB
	±0.06 dB with Accuracy Enhancement
-20 to -80 dB*	±0.5 dB
-80 to -100 dB*	±1.5 dB

*Only specified to -70 dB for 3 kHz bandwidth.

Stability (8 hr., 25°C ± 1°C after 3 hr. warmup)

100 Hz & 3 kHz BW	Temp. Coefficient (20°C-30°C)	
	±0.05 dB	±0.08 dB
10 kHz BW	±0.08 dB	±0.15 dB
0 dB	-20 dB	-80 dB

Phase (phase reference is channel A)

Range: -179.5° to +179.5° (display recycles).

Resolution: 0.01°.

Accuracy: (25°C ± 5°C).

Frequency Response (channel at 0 dB)

±0.8°	±0.2°	±1°
50 Hz	100 Hz	1 MHz
		13 MHz

Amplitude Response (channel B within 6 dB of channel A)

±0.4°	±0.6°	±1°
0 dB	-20 dB	-70 dB
		-80 dB

For channels at different levels (specification determination by lowest input).

±1.3°	±1.5°	±3.5°
0 dB	-20 dB	-60 dB
		-80 dB*

*Only specified to -70 dB for frequencies from 50 Hz to 60 kHz.

Linearity: ±0.2° (channel B within 6 dB of channel A).

Input impedance: 1 MΩ ± 2% shunted by <30 pF.

General

Programmability: all controls, except power switches, are programmable using the HP-IB format.

Ultra-high accuracy: the 3040A systems can be coupled with an external device such as a calibrated attenuator to provide relative measurements whose amplitude accuracy is limited to the amplitude stability of the receiver and source and the accuracy of the external device.

Options

The basic 3040A system options are listed below. For more information refer to the 3040A data sheet.

(Order Opt 110 or 111 and Opt 120 or 121)

110: standard 50 Ω 3570A

111: standard 75 Ω 3570A

(Options 110 and 111 include Delay/Limit Test/Offset and Cable Lead Kit)

120: standard 50 Ω 3330B

121: standard 75 Ω 3330B

NETWORK ANALYZERS

Gain/Phase Meter

Model 3575A

- dBV, dB ratio and degrees from 1 Hz to 13 MHz

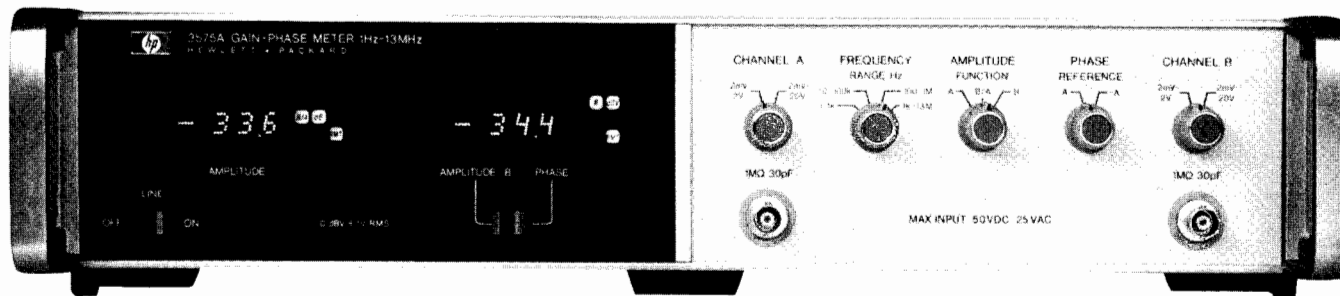

3575A Option 001 dual panel meters

Description

The HP 3575A Gain-Phase Meter is a versatile two-channel analyzer which can measure and display the absolute amplitude level or amplitude ratio of signals present at the inputs. In addition, the 3575A can measure the phase relationship of the two signals. This analyzer is a broadband detector, which is easy to use because no frequency tuning is required.

Since a dedicated tracking source is not required to operate with the 3575A, a wide selection of stimuli is possible. This flexibility coupled with a variety of possible amplitude, gain and phase outputs (LED display, analog outputs, and optional BCD) give you a wide choice of cost/results tradeoffs. For example, you may wish to manually plot your network response data on a Bode diagram in which case a low cost sinewave oscillator stimulus may be used. For easier, quicker results you may select a sweeping oscillator and an x-y plotter and let the instruments plot your response. You may use a calculator or computer to control a programmable stimulus source and the 3575A to provide automatic measurements. Here you have a wide range of computation and output possibilities.

Phase

The phase relationship of two signals is indicated over a range of ± 192 degrees with 0.1 degree resolution. A unique logic circuit (patent) design allows the 3575A to make stable phase measurements in the presence of noise. This feature minimizes the error to less than two degrees for a signal-to-noise ratio of 30 dB. One of three band limiting filters may be selected to get further noise rejection.

The 3575A is also capable of measuring the phase relationship of a variety of waveforms, such as square waves and triangle waves. Even harmonic and in-phase odd harmonic components of these signals cause no phase measurement error. For out-of-phase odd harmonic signal-to-harmonic ratios of 40 dB, measurement errors are less than 0.6 degree as shown in Figure 1.

Amplitude

The amplitude of either channel or the ratio of the two can be measured over an 80 dB dynamic range and 100 dB measurement range. Resolution is 0.1 dB. Results are displayed in dBV for channel amplitude and dB for ratio measurements. Digit blanking and channel overload annunciators will turn on if the maximum allowable signal level at either channel input is exceeded.

Readout

The standard three-digit LED display may be selected by the operator to indicate the amplitude of channel A or B, gain or phase. A second three-digit LED display is optionally available for simultaneous display of amplitude and phase readings. Lighted annunciators identify the measurement function, units and remote status.

Programmable

Two programmable options both offer full control of front panel functions and BCD output of information (amplitude, ratio or phase) contained in both digital displays. The two options give the user a choice of negative true or positive true outputs.

Applications

The 3575A can solve network analysis problems in the 1 Hz to 13 MHz frequency range where complex measurements (gain or phase or both) are required. A few of the many measurements it can make are: gain and phase response of feedback systems, envelope delay and return loss of transmission lines, complex impedance of components, and insertion loss of mixers and frequency doublers. Bode plots and Nichols charts are useful graphical tools for analyzing many of these response data.

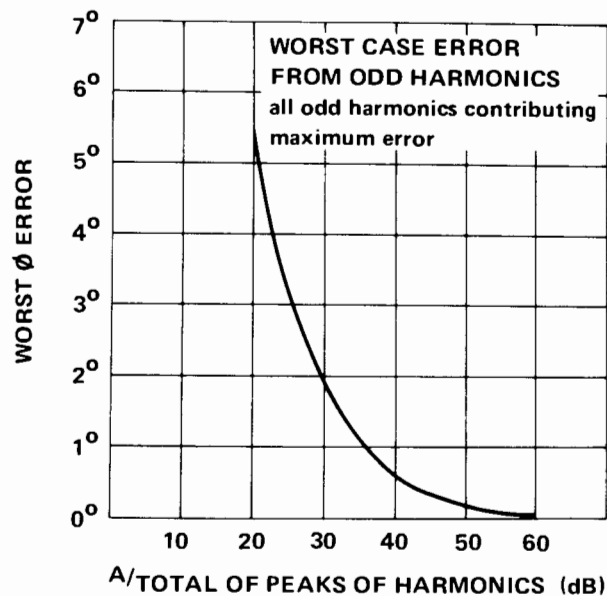
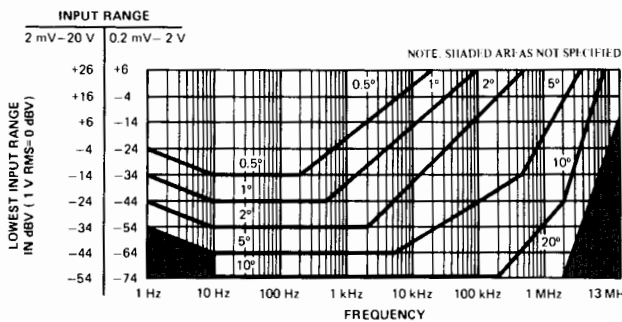

Figure 1. Worst case error from odd harmonics.

Specifications

Phase Accuracy*



*Conditions: Temperature: $25^{\circ}\text{C} \pm 10^{\circ}\text{C}$; Frequency range switch on lowest applicable range; Analog Output accuracy (rear panel).

Input signal range: 200 μV rms to 20 V rms.

Harmonic Rejection

Even harmonics: no error.

Odd harmonics: (in phase) no error.

Odd harmonics: (out of phase) 0.57° worst case error when total odd harmonic distortion is 40 dB below the fundamental.

Noise tolerance: 2° error for a 10 kHz, 1 V sine wave on one channel. One volt sine wave added to Gaussian noise (limited to a 1 MHz bandwidth and 30 dB S/N ratio) on the other channel. The 100 Hz to 1 MHz frequency range was used.

Display

Range: $\pm 180^{\circ}$ with 12° of overrange.

Resolution: 0.1° .

Panel meter accuracy: ± 3 counts (0.3 degrees/dB/dBV). The panel meter error must be added to the phase and amplitude errors to obtain the display error.

Inputs

Impedance: 1 M Ω 30 pF.

Protection: ± 50 V dc, 25 V rms.

Response Time to Achieve 95% of Final Reading

Frequency Range	Time
1 Hz to 1 kHz	20 s
10 Hz to 100 kHz	2 s
100 Hz to 1 MHz	0.2 s
1 kHz to 13 MHz	20 ms

Rear terminal inputs are available as a special (3575A-C09). Digital (Opt. 002). 0, +5 V; ground true. Twelve lines to fully program all functions.

Outputs

Analog

Phase: 10 mV/degree.

Amplitude: 10 mV/dB or dBV.

Output impedance: 1 k Ω

Digital (Opt 002): 0, +5 V; ground true. 31 output lines (1-2-4-8 BCD).

Digital readout: $3\frac{1}{2}$ digits with sign and annunciators. Four readings per second, fixed.

Amplitude Accuracy*

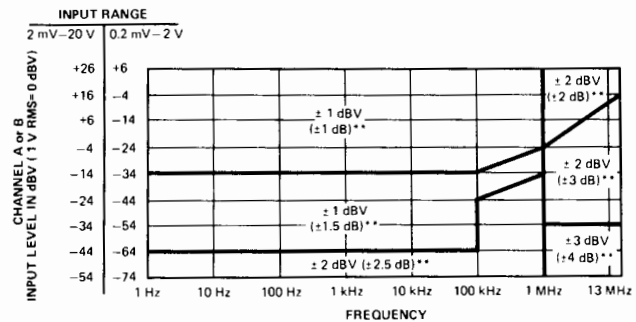

*Conditions: Temperature: $25^{\circ}\text{C} \pm 10^{\circ}\text{C}$; accuracy applies to dB V and ratio measurements with the same frequency on both channels; for ratio measurements, the lowest level channel determines accuracy; analog output accuracy (rear panel).

**Ratio (B/A) tolerances

Amplitude functions: A dBV, B dBV or B/A dB.

Amplitude reference: (A dBV, B dBV) 1 V rms = 0 dBV.

Display

Range: A dBV, B dBV: -74 dBV to $+26$ dBV (in two ranges). B/A dB: -100 to $+100$ dB. (Both input signals must be within the range of 0.2 mV rms to 20 V rms)

Resolution: 0.1 dBV, 0.1 dB.

General

Power: 115 V/230 V $\pm 10\%$, 48 Hz to 440 Hz, 40 VA.

Weight: net, 8.3 kg (18.4 lb). Shipping, 11.3 kg (25.8 lb).

Size: 88 H x 425 W x 337 mm D (3.47" x 16.75" x 13.25").

Accessories furnished: extender boards, line cable and 50-pin connector (Opt 002 and 003 only).

Options

001 Dual panel meters: HP's 3575A Opt 001 is equipped with two digital readouts and two analog outputs for simultaneous amplitude and phase readings. This option has no additional measurement capability over the standard instrument.

Dual analog outputs: rear panel BNC connectors provide dc output voltages that correspond to the respective panel meter readings.

001: Dual Readout

002/003 Programmable: 3575A Opt 002 and Opt 003 are equipped with dual panel meters and dual analog outputs (same as Opt 001) plus BCD outputs and complete remote control capability. Opt 002 has negative true output levels and Opt 003 has positive true output levels. BCD information from the 3575A (Opt 002) can be read by the 9800 series HP Desktop Computers with appropriate interfacing.

002: Programmable (negative true output levels)

003: Programmable (positive true output levels)

908: Rack Flange Kit

910: Extra Product Manual

3575A Gain/Phase Meter

NETWORK ANALYZERS

RF Network Analyzer, 4 MHz to 1300 MHz (optional to 2600 MHz)

Model 8754A

- Integrated source, receiver, and display
- H26 option covers 4 to 2600 MHz
- Three inputs, two measurement channels
- 80 dB dynamic range

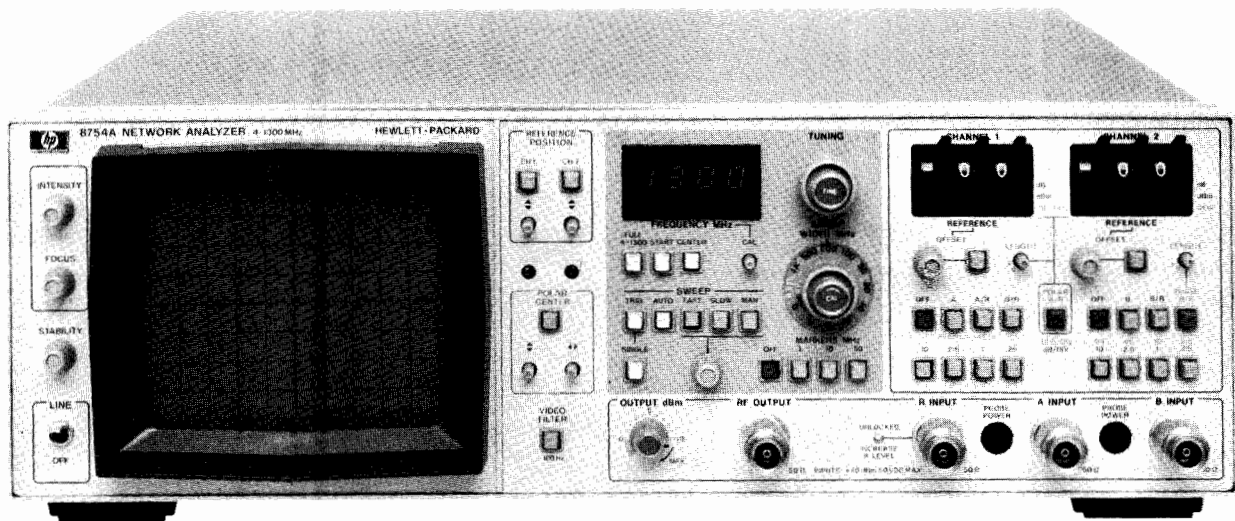

Description

The 8754A is a complete stimulus/response test system which combines a 4-1300 MHz swept source, three-input narrowband, tuned receiver, and both rectilinear and polar displays in a compact package. The convenient built-in source incorporates digital display of the start or center frequency, the ability to sweep all or any portion of the 4-1300 MHz range, and crystal markers at 1, 10, or 50 MHz intervals to enable accurate frequency calibration and measurement. The receiver provides 80 dB dynamic range in two independent measurement channels to allow simultaneous measurement of any two transmission or reflection parameters using a single test setup. Measurements of absolute power, magnitude ratio, phase angle, and reflection coefficient (or return loss) are displayed on the fully calibrated CRT with resolutions up to 0.25 dB and 2.5 degrees per major division. With these features the 8754A offers a new level of operating convenience and technical performance to swept magnitude and phase measurements in laboratory, production, and field testing applications at an economical price.

A comprehensive line of 50 Ohm and 75 Ohm test sets allow you to tailor your test setup for a specific measurement using the minimum of equipment, or to provide the maximum in versatility for a wide range of applications. Signal separation devices include the 11850 Power Splitter for precision transmission measurements, the 8502 Transmission/Reflection Test Set for simultaneous transmission and reflection measurements, the 8748A S-Parameter Test Set to measure both forward and reverse S-Parameters. Also available for in-circuit testing is the 1121A AC Probe (probe power is supplied directly from the front panel of the 8754A). Matched cable sets, precision adapters, and transistor fixtures provide convenient, reliable connections to the test device. Adding the 8750A Storage Normalizer provides flicker-free rectilinear displays regardless of sweep rate. The 8750A will automatically store and subtract out the frequency response of a test set or cable if necessary, eliminating the need to use a

grease pencil when making normalized measurements. For applications that require exceptional frequency accuracy and stability, the 8754A may be used with external sources such as the HP 8660, 8662A, 8663A or HP 8640 Signal Generators.

Coverage to 2600 MHz

The 8754A Option H26 provides an economical solution for magnitude and phase measurements to 2600 MHz. Frequency coverage to 2600 MHz is obtained by adding an external frequency doubler (supplied with Option H26) to the RF source output and engaging the "DOUBLER" pushbutton on the front panel. The external frequency doubler doubles the RF output frequency while the "DOUBLER" pushbutton changes the phase lock circuitry that enables the receiver to lock onto and track signals up to 2600 MHz. In this doubled mode of operation it is necessary to multiply the indicated frequency settings by two for a proper reading. The frequency span between the 1, 10 and 50 MHz crystal markers is also doubled but their excellent accuracy and stability are unaffected. The performance of the source and doubler combination is specified from 100 MHz to 2600 MHz although it is usable down to 8 MHz.

A comprehensive line of 50 Ohm 2600 MHz test sets and accessories allow you to tailor your test setup for a specific measurement. For the maximum in versatility, use the 8748A Option H26 S-Parameter Test Set which allows characterization of forward and reverse S-Parameters without physically reversing the device. Other test sets include the 8502A Option H26 Transmission/Reflection Test Set for simultaneous transmission and reflection measurements and the 11850A Option H26 Power Splitter for transmission measurements. Matched cable sets, adapters and transistor fixtures with coverage up to 2600 MHz are also available for connections to test devices.



8754A Network Analyzer Specifications

Source

Frequency range: 4 to 1300 MHz. Option H26 coverage is 4 to 2600 MHz; 4 to 1300 MHz in normal mode, 100 to 2600 MHz in doubled mode (usable down to 8 MHz).

Sweep modes: linear full sweep (4 to 1300 MHz or 8 to 2600 MHz in doubled mode) and calibrated sweep widths with variable start or center frequency.

Sweep widths: selectable sweep width ranges from 1 to 1000 MHz (2 to 2000 MHz with Option H26) in a 1, 2, 5 sequence, plus CW. A vernier allows continuous adjustment of sweep width within each range and calibration to internal crystal makers.

Spectral Purity (+10 dBm RF output level)

Residual FM (swept and CW): ≤ 7 kHz rms (10 kHz bandwidth).

Harmonics: -28 dBc.

Output power range: 0 to +13 dBm typical, ± 0.5 dB flatness. Option H26 100 to 2600 MHz: (measured at the output of the doubler with +10 dBm at the input, frequency doubler has approx. 14 dB of conversion loss).

Residual FM (swept or CW): ≤ 14 kHz rms (10 kHz bandwidth).

Harmonics: Second typically -15 dBc, Third typically -25 dBc.

Output power range: 0 to +13 dBm typical, ± 0.5 dB flatness.

Receiver

Frequency: 4 MHz to 1300 MHz. Option H26 ("DOUBLER" pushbutton engaged): 8 to 2600 MHz.

Input channel: two test inputs (A and B) and one reference (R) input.

Input connectors: type-N Female, 50 ohms nominal impedance.

Input port match: ≥ 20 dB Return Loss (1.22 SWR).

Option H26:

1300 to 2000 MHz: ≥ 13 dB Return Loss (1.58 SWR).

2000 to 2600 MHz: ≥ 9 dB Return Loss (2.10 SWR).

Maximum input level: 0 dBm at R, A, B inputs.

Damage level: +20 dBm (50 Vdc).

Noise level: < -80 dBm at A and B inputs.

Minimum R input level: -40 dBm (≥ -40 dBm required to operate R input phase-lock).

Crosstalk between channels: > 83 dB.

Magnitude frequency response (flatness)

Absolute (A,B): $\leq \pm 1$ dB.

Ratio (A/R, B/R): $\leq +0.3$ dB.

Option H26: 8 to 2000 MHz: $\leq \pm 0.7$ dB.

8 to 2600 MHz: $\leq \pm 1.3$ dB.

Magnitude dynamic accuracy: ± 0.3 dB from 0 to -50 dBm, ± 0.5 dB from -50 to -60 dBm, ± 1 dBm from -60 to -70 dBm, ± 2.5 dB from -70 to -80 dBm.

Magnitude reference offset range: ± 199 dB in 1 dB steps. Vernier provides variable offset for calibration.

Absolute power measurements (A, B, and R): typically ± 0.5 dBm at 0 dBm, 50 MHz input.

Phase frequency response: $\pm 2.5^\circ$ (typically $\pm 1^\circ$); Option H26 1300-2600 MHz, $\pm 5^\circ$.

Phase range: $\pm 180^\circ$.

Phase dynamic accuracy: $\pm 2^\circ$ from 0 to -50 dBm, $\pm 4^\circ$ from -50 to -70 dBm.

Phase reference offset range: $\pm 199^\circ$ in 1° steps. Vernier provides variable offset for calibration.

Electrical length adjustment range: typically 0 to 16 cm length for transmission phase; typically 0 to 8 cm reference plane extension for reflection measurements. Option H26 (to 2600 MHz) typically up to 8 cm for transmission phase; up to 4 cm for reflection.

Display

Measurement functions: CRT displays either polar trace or Channel 1 and Channel 2 rectilinear traces.

Reference position: independent reference lines for Channel 1 and Channel 2 and polar center can be set to any position for calibration.

Video filter: typically 100 Hz (10 kHz without filter).

Graticule size: rectilinear 10 cm by 8 cm; polar 8 cm in diameter.

Smith chart overlays: 2, 1, 0.2 and 0.1 full scale (furnished).

CRT photography: Tektronix C-5B Oscilloscope Camera is recommended (UV illumination will not excite P39 CRT phosphor for graticule exposure).

Resolution: 10, 2.5, 1, 0.25 dB magnitude per major division. 90, 45, 10, 2.5 degrees phase per major division.

Accuracy: $\pm 2\%$ ± 0.05 division for rectilinear trace. Within 2.5 mm for polar trace.

General

Sweep output: -5 V to $+5$ V.

External sweep inputs: 0 to 10 V nominal.

X-Y Recorder/External CRT Output

Horizontal and vertical: 0.1 V/div.

Penlift/blinking: +5 V Blanking and Penlift.

External marker input: typically -13 dBm RF signal produce a marker at the frequency of the RF signal.

Magnitude/phase output: -10 mV/Degree and -100 mV/dB.

Probe power: Two +15 Vdc and -12.6 Vdc.

Storage-Normalizer interfaces: directly compatible with the HP 8750A Storage-Normalizer. HP 8501A Storage-Normalizer requires a single internal adjustment for compatibility.

Programming connector: outputs include magnitude/phase and sweep outputs and inputs described above as well as measurement mode selection by TTL levels or contact closures.

External source: the 8754A sweep-out voltage is provided to frequency modulate (sweep) an external signal generator for narrow-band measurement applications. A sweep input is provided to synchronize the CRT display for use with an externally swept source (8620 and 8350 Series).

Temperature

Operating: 0° to 55° C except where noted.

Storage: -40° C to $+75^\circ$ C.

EMI: VDE 0871/0875 and CISPR publication 11.

Safety: conforms to the requirements of IEC 348.

Power: selection of 100, 120, 220 and 240 V $+5\%$ -10% . 48 to 66 Hz, 20 VA max.

Size: 425.5 mm W x 133 mm H x 505 mm D (16 $\frac{3}{4}$ " x 5 $\frac{1}{4}$ " x 19 $\frac{7}{8}$ ").

Weight: net 16.8 kg (37 lb). Shipping 19 kg (42 lb).



NETWORK ANALYZERS

RF Network Analyzer

Model 8754A (cont.)

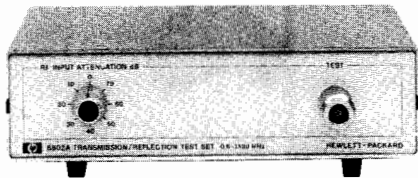

8502A

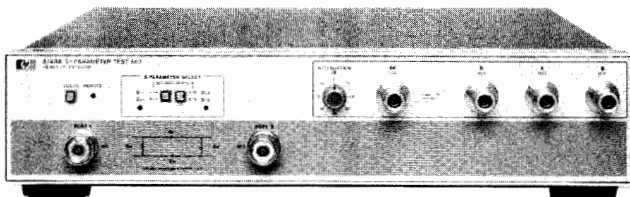

8748A

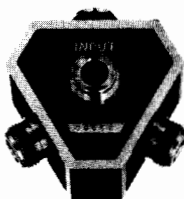

11850A

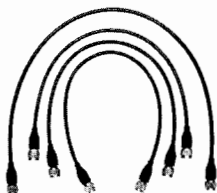

11851A

8748A 50 Ohm S-Parameter Test Set Specifications

Frequency Range: 4 to 1300 MHz. Option H26: 4 to 2600 MHz.

Directivity: ≥ 40 dB.

Option H26: 4 to 1300 MHz; ≥ 35 dB.

1300 to 1600 MHz; ≥ 30 dB.

Frequency Response¹:

Transmission (S_{21} , S_{12}): ± 1 dB, $\pm 8^\circ$.

Option H26 (2600 MHz frequency range):

4 to 1300 MHz: ± 1 dB, $\pm 8^\circ$.

1300 to 2600 MHz: ± 1.5 dB, $\pm 15^\circ$.

Reflection (S_{11} , S_{22}): ± 2 dB, $\pm 15^\circ$.

Option H26 (2600 MHz frequency range):

4 to 1300 MHz: ± 2 dB, $\pm 15^\circ$.

1300 to 2600 MHz: ± 3 dB, $\pm 20^\circ$.

Port Match²:

Test Port 1 and 2: ≥ 26 dB Return Loss (≤ 1.11 SWR).

Test Port 1 and 2 open/short ratio: ± 0.75 dB and $\pm 6^\circ$ from 4 to 1000 MHz, ± 0.9 dB and $\pm 7.5^\circ$ from 1000 to 1300 MHz.

Option H26:

Test Port 1 and 2:

4 to 1300 MHz; 22 dB Return Loss.

1300 to 2600 MHz; 17 dB Return Loss.

Test Port 1 and 2 open/short ratio:

4 to 1300 MHz: ± 1.2 dB, $\pm 10^\circ$.

1300 to 2600 MHz: ± 1.5 dB, $\pm 15^\circ$.

Insertion Loss:

Input to Test Port 1 or 2: 13 dB nominal.

Input to Port A, B or R: 19 dB nominal.

Option H26: same

Maximum Operating Level: +20 dBm.

RF Attenuator Range: 0 to 70 dB in 10 dB steps.

Test Port Connectors: APC-7.

DC Bias Input Range: ± 30 Vdc, ± 200 mA.

Includes: cables for connection to 8754 and Reference Plane Extension Cable Kit.

Recommended Accessory: 11857A Test Port Extension Cables, 11608A Transistor Fixture, or 11600B, 11602B Transistor Fixtures.

Power: 20Vdc, supplied from 8754 via interface cable (included).

Size: 432mmW x 90mmH x 495mmD (17" x 3 1/2" x 19 1/2").

Weight: net, 9.1 kg (20 lb). Shipping, 11.3 kg (25 lb).

8502A 50 Ohm Transmission/Reflection Test Set

8502B 75 Ohm Transmission/Reflection Test Set

General: the 8502 contains a power splitter and directional bridge that permits simultaneous transmission and reflection measurements.

Detailed specifications on the 8502A and 8502B appear on page 452. The 8502A Option H26 is intended as an accessory to the 8754A Option H26 and allows 50 ohm transmission/reflection measurements up to 2600 MHz. For interconnections from the 8502 to the 8754A use the 11851A RF Cable Set. The major specifications of the 8502A option H26 are:

Frequency Range: 4 to 2600 MHz.

Directivity:

4 to 1300 MHz: ≥ 35 dB.

1300 to 2600 MHz: ≥ 30 dB.

Frequency Response:

Transmission:

4 to 1300 MHz: ≤ 0.9 dB, $\leq \pm 10^\circ$.

1300 to 2600 MHz: $\leq \pm 1.5$ dB, $\leq \pm 15^\circ$.

Reflection:

4 to 1300 MHz: $\leq \pm 1.8$ dB, $\leq \pm 10^\circ$.

1300 to 2600 MHz: $\leq \pm 3.0$ dB, $\leq \pm 15^\circ$.

Port Match:

Test Ports:

4 to 1300 MHz: ≥ 22 dB Return Loss (≤ 1.17 SWR).

1300 to 2600 MHz: ≥ 17 dB Return Loss (≤ 1.33 SWR).

Test Port Open/Short Ratio:

4 to 1300 MHz: $\leq \pm 1.2$ dB, $\leq \pm 10^\circ$.

1300 to 2600 MHz: $\leq \pm 1.5$ dB, $\leq \pm 15^\circ$.

Reference and Reflection Port:

4 to 1300 MHz: ≥ 22 dB (≤ 1.17 SWR).

1300 to 2600 MHz: ≥ 17 dB (≤ 1.33 SWR).

Input Port

4 to 1300 MHz: ≥ 20 dB (≤ 1.22 SWR).

1300 to 2600 MHz: ≥ 12 dB (≤ 1.67 SWR).

11850A 50 Ω Three-Way Power Splitter

11850B 75 Ω Three-Way Power Splitter

General: one output port provides the reference output and the other two output ports can be used for independent transmission measurements. Use the 11851A RF Cable Set for interconnections. Detailed specifications on page 452.

11851A RF Cable Set

General: three 61 cm (24 in.) 50 Ω cables, phase matched to $\pm 4^\circ$ and one 86 cm (34 in.) 50 Ω cable. Used with 8502A/B and 11850A/B. Detailed specifications on page 453.

11857A APC-7 Test Port Extension Cables

General: two precision 50 Ω cables phase matched to $\pm 2^\circ$ to connect test device between 8748A test ports. Detailed specifications on page 453.

Transistor Fixtures

General: three transistor fixtures can be used with the 8748A. The 11600B and 11602B require use of the 11858A Transistor Fixture Adapter. The 11608A transistor fixture connects directly to the 8748A. Detailed specifications on pages 460 and 462.

Adapter Kits

General: the 11853A, 11854A, 11855A, and 11856A accessory kits are available to provide precision Type N and BNC adapters and calibration standards for use with the 11850A/B, 8502A/B, and 8748A test setups. Detailed specifications on page 453.

¹ \pm degrees, specified as deviation from linear phase.

² Effective port match for ratio measurements.

Ordering Information

8754A Network Analyzer

Opt H26: 4-2600 MHz

Opt 907: Front Handle Kit

Opt 908: Rack Flange Kit

Opt 909: Rack Mount Flange/Front Handle Kit

11850A 50 Ω Three-Way Power Splitter

Opt H26: 4-2600 MHz (50 Ω)

11850B 75 Ω Three-Way Power Splitter

8502A 50 Ω Transmission/Reflection Test Set

Opt H26: 4-2600 MHz (50 Ω)

8502B 75 Ω Transmission/Reflection Test Set

11851A RF Cable Set

11857A Test Port Extension Cables

8748A 50 Ω S-Parameter Test Set

Opt 907: Front Handle Kit

Opt 908: Rack Flange Kit

Opt 909: Rack Mount Flange/Front Handle Kit

Opt H26: 4-2600 MHz (50 Ω)

- Accurate voltage and phase measurement
- 1 to 1000 MHz

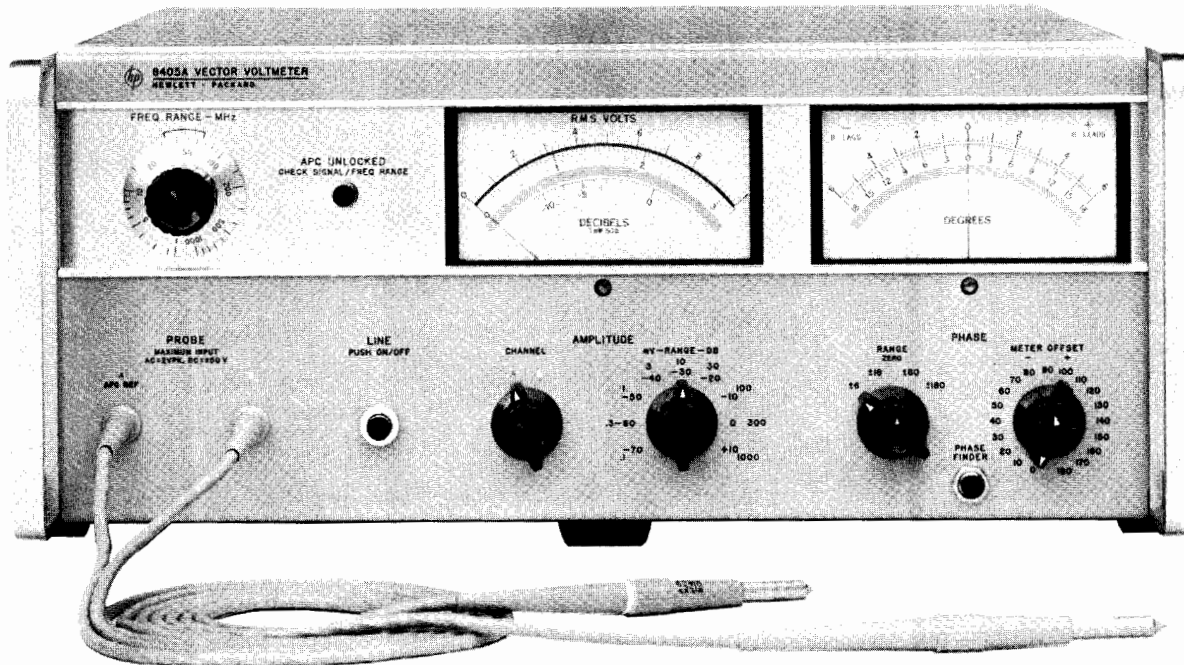

The 8405A Vector Voltmeter measures voltage vectors described by both magnitude and phase. This capability makes the 8405A a unique instrument for about any design and test application in the frequency range 1 to 1000 MHz.

In addition to absolute voltage measurements, capabilities include insertion loss and computed group delay of bandpass filters and other transmission devices, gain and phase margin of amplifiers, complex impedance of mixers, antennas, matching the electrical lengths of cables, s-parameters of transistors, amplitude modulation index, RF distortion measurements and in-circuit probing.

The 8405A achieves this measurement versatility through its two-channel capability enabling voltage magnitude measurements in either channel, thus allowing ratio measurements, and phase difference measurements between the two channels. Gain or loss in excess of 90 dB and phase measurements with 0.1° resolution over a 360° phase range are possible.

Accuracy is achieved through the 1 kHz bandwidth entailing response only to the fundamental frequency of the input signal. Also, phase-locked coherent sampling to translate 1 to 1000 MHz RF signals to 20 kHz IF signals enables accurate detection of voltage magnitude and phase. Automatic phase-locked tuning makes it possible to select the one of 21 overlapping octave ranges which contains the input signal frequency by simply rotating a switch.

Specifications

Frequency range: 1 MHz to 1 GHz in 21 overlapping octave bands; tuning automatic within each band.

Isolation between channels: 1 to 300 MHz, >100 dB; 300 to 1,000 MHz >80 dB.

Maximum input: ac, 2 V peak; dc, ±50 V.

Input impedance (nominal): 0.1 MΩ shunted by 2.5 pF; 1 MΩ shunted by 2 pF when 11576A 10:1 Divider is used; 0.1 MΩ shunted by 5 pF when 10216A Isolator is used. AC coupled.

Voltage Range (rms)

Channel	1 - 10 MHz	10 - 500 MHz	500 - 1000 MHz
A	1.5 mV - 1.0 V	300 μV - 1.0 V	500 μV - 1.0 V
B	<100 μV - 1.0 V	<100 μV - 1.0 V	<100 μV - 1.0 V

Voltmeter ranges: 100 μV to 1 V rms full scale in 10 dB steps.

Voltage ratio accuracy: 1-200 MHz, 0.2 dB for -60 to 0 dB ranges and 0.5 dB for -70 dB and +10 dB ranges; 200-1000 MHz, 0.2 dB for -60 to -10 dB ranges, 0.5 dB for -70 dB and 0 dB ranges and 1.5 dB for +10 dB range.

Phase range: 360° indicated on zero-center meter with end-scale ranges of ±180°, ±60°, ±18°, and ±6°.

Phase resolution: 0.1° at any phase angle.

Phase meter offset: ±180° in 10° steps.

Phase accuracy: ±1.5° (equal voltage Channel A and B).

Accessories furnished: two 11576A 10:1 Dividers, two 10216A Isolators, two 10218A BNC Adapters, six ground clips for 11576A or 10216A; six replacement probe tips.

Bandwidth: 1 kHz.

Power: 115 or 230 V ±10%, 50 to 60 Hz, 35 W.

Weight: net, 13.9 kg (31 lb). Shipping, 16.3 kg (36 lb).

Size: 177 H x 425 W x 467 mm D (7.0" x 16.75" x 18.38").

11570A Accessory Kit

50 Ω Tee: 11536A: for monitoring signals on 50 Ω transmission lines without terminating line. Kit contains two with type N RF fittings.

50 Ω Power splitter: 11549A: all connectors Type N female.

50 Ω Termination: 908A: for terminating 50 Ω coaxial systems in their characteristic impedance.

Shorting plug: 11512A: Shorting Plug, Type N male.

Ordering Information

8405A Vector Voltmeter

Opt 002: linear dB scale

11570A Accessory Kit (measurement in 50 Ω systems only)



NETWORK ANALYZERS

RF Network Analyzer, 500 kHz to 1.3 GHz

Model 8505A

- 100 dB of dynamic range
- Digital readout of data with analog display
- Direct group delay and deviation from linear phase
- High performance sweep oscillator
- Complete family of 50 Ω and 75 Ω test sets
- Digital storage and normalization

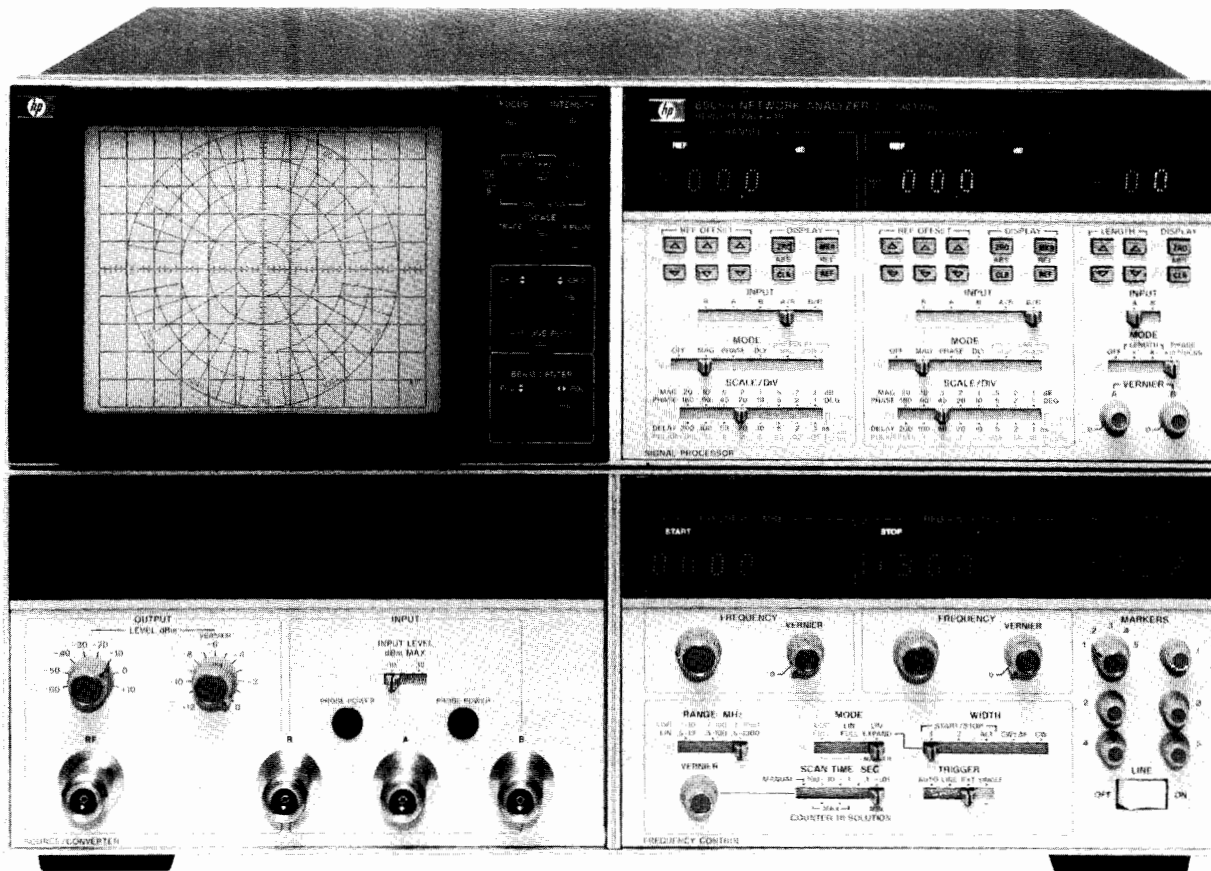

8505A



The HP 8505A is a high performance RF network analyzer operating over the 500 kHz to 1.3 GHz frequency range. It accurately and easily measures complex impedance, transfer functions and group delay of coaxial components and semiconductors. Because both magnitude and phase are measured, it is possible to completely characterize the linear behavior of either active or passive networks.

Since magnitude and phase can be measured and displayed over 100 dB of dynamic range (-10 to -110 dBm), it is a simple process for the 8505A to measure transmission loss of high rejection devices such as filters or gain and return loss of small signal devices like amplifiers. Distortion parameters like group delay, deviation from linear phase, and deviation from constant amplitude are measured in an equally straightforward manner. Group delay is measured and displayed directly to resolutions of 1 ns per major division using a new linear FM measurement technique. A unique new electrical line stretcher compensates for the linear phase shift of the device under test so that phase non-linearities may be examined at high resolution (1° per major division). Amplitude deviations with frequency can be similarly observed to resolutions 0.1 dB per major division with clear, crisp trace stability. In addition, it is possible to read out swept amplitude, phase and delay digitally at any one of five continuously variable markers with resolutions of 0.01 dB, 0.1°, and 0.1 ns respectively.

Many of the 8505A's high performance features and operating conveniences are derived from the fact that it is a completely integrated system including both the sweep oscillator and receiver. The basic instrument also includes a built-in frequency counter, polar and rectangular displays on the same CRT, the new electronic line stretcher, group delay measurement, and frequency selective digital readings of swept amplitude, phase and delay. The frequency counter with resolutions up to 100 Hz adds further precision to the measurements by allowing frequency as well as amplitude, phase and delay to be read out at any of the five markers. The 8505A is fully programmable in a straightforward fashion using the Hewlett-Packard Interface Bus (HP-IB operation is standard). The user can configure a customized automatic system or for convenience HP offers a fully configured system, the 8507D. (See pages 454, 455.)

Companion instruments include the 11850A Three Way Power Splitter for high resolution transmission comparison measurements, the 8502A Transmission/Reflection Bridge for simultaneous transmission and reflection measurements, and the 8503A S-parameter Test Set for complete characterization of two port devices in a single test set-up. The 8501A Storage-Normalizer adds digital storage, normalization, signal averaging, increased resolution, and graphics to 8505A measurements.

8505A Specifications

Source

Frequency Characteristics

Frequency range: 500 kHz to 1.3 GHz in three ranges; 500 kHz to 13 MHz, 500 kHz to 130 MHz and 500 kHz to 1.3 GHz.

Swept frequency accuracy: $\pm 1\%$ of range for linear sweep.

CW frequency accuracy: ± 2 counts \pm time-base accuracy.

Frequency stability: better than $\pm 0.01\%$ of reading $\pm 0.01\%$ of frequency range over 10 minutes after warm-up.

Frequency counter characteristics: frequency counter measurements are made at any one of five continuously variable marker positions without interrupting the swept RF signal.

Resolution (least significant digit)

Frequency Range (MHz)	0.5 to 13	0.5 to 130	0.5 to 1300
10 ms Sweep time	10 kHz	100 kHz	1 MHz
100 ms Sweep time	1 kHz	10 kHz	100 kHz
>1 second Sweep time	100Hz	1 kHz	10 kHz

Counter accuracy: ± 2 counts \pm time-base accuracy.

Marker frequency accuracy: $\pm 0.002\%$ of scan width \pm counter accuracy. Measured in CW $\pm \Delta F$

Time-base accuracy: ± 5 ppm ± 1 ppm/ $^{\circ}\text{C}$ ± 3 ppm/90 days

Output Characteristics

Output power range: +10 dBm to -72 dBm.

Attenuator accuracy: ± 1.5 dBm over 70 dB range.

Vernier accuracy: ± 1 dB.

Leveling: ± 0.5 dB from 500 kHz to 1.3 GHz.

Impedance: 50 Ω ; ≥ 16 dB return loss at -10 dBm output level (<1.38 SWR).

Residual FM

Frequency Range (MHz)	0.5 to 13	0.5 to 130	0.5 to 1300
Residual FM	50 Hz rms	200 Hz rms	2 kHz rms
Bandwidth	20 Hz-1 kHz	20 Hz-1 kHz	20 Hz-10 kHz

Harmonics: >25 dB below main signal at +10 dBm output level.

Sub-harmonics and spurious signals: below -50 dBm at +10 dBm output level.

General Characteristics

Sweep modes: linear Full, Log Full, Start/Stop 1, Start/Stop 2, Alternate, CW $\pm \Delta F$, and CW.

Sweep times: 10 ms to 100 s in decade ranges.

Trigger modes: auto, line sync., single scan or external sync.

RF Output connector: type N female

Receiver

Frequency range: 500 kHz to 1.3 GHz

Input Characteristics

Input channels: three channels (R, A, and B) with 100 dB dynamic range.

Damage level: +20 dBm or ≥ 50 V dc.

Noise (average, 10 kHz BW): -110 dBm from 10 to 1300 MHz; -100 dBm from 2 to 10 MHz; -95 dBm from 0.5 to 2 MHz.

Impedance: 50 Ω ; ≥ 20 dB return loss (<1.22 SWR). Typically >26 dB return loss (<1.11 SWR).

Magnitude Characteristics

Absolute frequency response (A, B, R): ± 1.5 dB

Ratio frequency response (A/R, B/R): ± 0.3 dB from 0.5 MHz to 1.3 GHz.

Dynamic accuracy: ± 0.01 dB/dB from -20 to -40 dBm; ± 0.2 dB from -10 to -50 dBm; ± 0.5 dB from -50 to -70 dBm; ± 1.0 dB from -70 to -90 dBm; ± 2.0 dB from -90 to -100 dBm; ± 4.0 dB from -100 to -110 dBm.

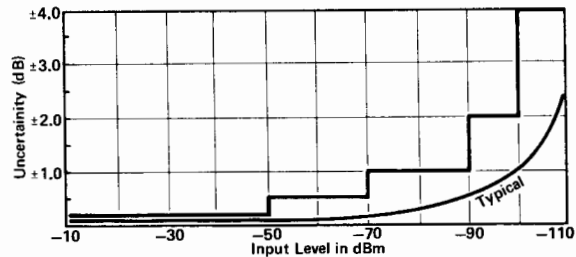

Crosstalk error limits: >100 dB isolation between inputs.

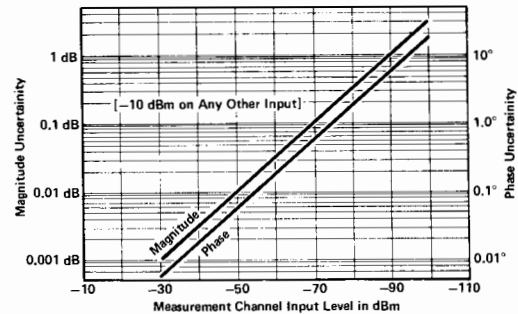

Reference offset range: ± 199.9 dB

Reference offset accuracy: ± 0.03 dB ± 0.003 dB/dB of offset

Marker measurement resolution: 0.01 dB over any <10 dB range; 0.1 dB over any ≥ 10 dB range.

CRT display resolution: 0.1 dB to 20 dB/division in 1, 2, 5 sequence.

Phase Characteristics

Frequency response: $\pm 3^{\circ}$ from 500 kHz to 750 MHz; $\pm 5^{\circ}$ from 750 MHz to 1.3 GHz.

Range: $\pm 180^{\circ}$.

Accuracy: $\pm 0.01^{\circ}/\text{degree}$ for $\pm 170^{\circ}$; $\pm 0.01^{\circ}/\text{degree} \pm 0.5^{\circ}$ for $\pm 180^{\circ}$.

Dynamic accuracy (in 10 kHz Bandwidth): $\pm 0.02^{\circ}/\text{dB}$ from -20 to -40 dBm; $\pm 0.5^{\circ}$ from -10 to -50 dBm; $\pm 1^{\circ}$ from -50 to -70 dBm; $\pm 3^{\circ}$ from -70 to -90 dBm.

Crosstalk: see amplitude crosstalk specification.

Reference offset accuracy: $\pm 0.3^{\circ} \pm 0.5\%$ of offset.

Marker measurement resolution: $\pm 0.1^{\circ}$ over <100 $^{\circ}$ range and 1° for $\geq 100^{\circ}$ range.

CRT display resolution: 1° to 180° per division in 8 steps.

Polar characteristics: frequency Response, Dynamic Response, Reference Offset and Marker Measurement specifications are the same as magnitude and phase characteristics.

CRT display accuracy: actual value is within less than 3 mm circle of the displayed value.

Tracking between dB offset controls and polar full switch positions: ≤ 0.2 dB.

Full scale magnitude range: 1 to 0.01 in a 1, 0.5, 0.2 sequence.

Delay Characteristics

Frequency response: ± 1 ns from 500 kHz to 1.3 GHz.

Delay accuracy: $\pm 3\%$ of reading ± 3 units (Units = 1ns for 0.5 to 1300 MHz range, 10 ns for 0.5 to 130 MHz range, and 100 ns for 0.5 to 13 MHz range.).

¹ ± 3 units may be calibrated out with thru connection.



NETWORK ANALYZERS

RF Network Analyzer, 500 kHz to 1.3 GHz (cont.)

Model 8505A

Range Resolution and Aperture

Frequency Range (MHz)	0.5 to 13	0.5 to 130	0.5 to 1300
Range	0 to 80 μ s	0 to 8 μ s	0 to 800 ns
Resolution			
CRT:	100 ns	10 ns	1 ns
Marker:	100 ns	10 ns	1 ns
Marker with Delay scale/Div Switch set to:	10 ns (<1 μ s)	1 ns (\leq 100 ns)	0.1 ns (\leq 10 ns)
Aperture ¹	7 kHz	20 kHz	200 kHz

Reference offset range: ± 1999 dB

Reference offset accuracy: ± 0.3 units $\pm 0.3\%$ of offset.

Electrical Length/Ref. Plane Extension Characteristics Calibrated Electrical Length Range and Resolution²

Frequency Range (MHz)	0.5 to 13	0.5 to 130	0.5 to 1300
Range			
X1	± 19.9 m	± 1.99 m	± 19.9 cm
X10	± 100 m	± 10 m	± 1 m
Resolution			
X1	10 cm	1 cm	0.1 cm
X10	1 m	10 cm	1 cm

Calibrated electrical length accuracy: $\pm 3\%$ of reading $\pm 1\%$ of range.

Linear phase substitution (degrees/scan) range: $\pm 1700^\circ$ per scan with 0° offset.

$$\frac{\pm 1.4 \text{ km}}{\text{scan width (MHz)}} \quad \text{or} \quad \frac{\pm 4.7 \mu\text{s}}{\text{scan width (MHz)}}$$

Linear phase substitution resolution: 10°

Linear phase substitution accuracy: $\pm 3\%$ of reading $\pm 10^\circ$ / scan

Phase compensation linearity: $<0.2\%$ of phase slope inserted.

General Characteristics

RF input connectors: type N Female

Display bandwidth: selectable IF bandwidths of 10 kHz and 1 kHz. A video filter position is also provided.

CRT overlays: Smith Charts (2, 1, 0.5, 0.2, 0.1 full scale), Log Charts (10 MHz, 100 MHz and 1000 MHz).

CRT photography: HP 197A Opt 006 camera or HP 197A with 10375A Bezel Adapter required to fit 8505A display. A CRT illumination control is provided.

Auxiliary Outputs

Channel 1 and 2 outputs: 0.25 V/display division.

Sweep output: 0.25 V/display division.

Pen lift: dc coupled, 200 mA current sink.

Programming

The 8505A has a remote programming interface using the Hewlett-Packard Interface Bus with Learn Mode. One 0.5 m (HP 10833D) HP-IB cable included.

Power: selection of 100, 120, 200 or 240 V $\pm 5\%$ -10% . 50 to 60 Hz approximately 275 watts.

Size: 279 H x 426 W x 553 mm D (11 x 16.75 x 21.75 in.).

8505A Opt 005 Specifications (phase-lock operation)

Source

Frequency Characteristics

Modes (8505A): CW and CW $\pm \Delta F$ only.

Range and resolution (8505A and 8660C/86602B/86632B): the total frequency range is 1 to 1300 MHz with a CW resolution of 1 Hz (set on the 8660C). The maximum $\pm \Delta F$ and $\pm \Delta F$ resolution is 1.3 kHz and 1 Hz from 0.5 to 13 MHz, 13 kHz and 10 Hz from 0.5 to 130 MHz, and 130 kHz and 100 Hz from 0.5 to 1300 MHz respectively.

Range and resolution (8505A and 8640B Opt 002): (total frequency range: 0.5 to 1024 MHz).

	8640 Frequency Ranges (MHz)	8505A Frequency Range (MHz)		
		0.5-13	0.5-130	0.5-1300
CW Resolution (Set on 8640B)	0.5-1 1-13 16-128 128-1024	0.1 Hz 1 Hz	10 Hz	10 Hz 100 Hz
$\pm \Delta F$ Resolution (Set on 8505A)	All freq. Ranges	1 Hz	10 Hz	100 Hz
Max $\pm \Delta F$	0.5-8 8-16 16-1024	1.3 kHz 1.3 kHz	13 kHz 13 kHz	130 kHz

Typical system residual FM: the Residual FM of a phase-locked 8505A approaches that of the 8660C/86602B/86632B or 8640B.

Output Characteristics

Power output, harmonics, spurious outputs, RF noise, etc. are determined by the 8660C with 86602B and 86632B or the 8640B.

Receiver

Magnitude and phase characteristics are unchanged with the exception of the dynamic range specification.

Delay Characteristics

Accuracy: $\pm 3\%$ of reading ± 3 units. Units: 1 μ s for 0.5-1300 MHz; 10 μ s for 0.5-130 MHz; 100 μ s for 0.5-13 MHz.

Range, resolution and aperture: (8660C/86602B/86632B or 86640B)

(8505A indicated units x 1000)

	8505 Frequency Range (MHz)		
	0.5-13	0.5-130	0.5-1300
Range	0-80 ms	0-8 ms	0-800 μ s
Resolution:			
CRT & Digital Marker	100 μ s	10 μ s	1 μ s
Digital Marker with Delay Switch Setting	10 μ s <1 ms	1 μ s <100 μ s	100 ns <10 μ s
Aperture ¹	1.5 kHz	2.0 kHz	4.0 kHz

Electrical Length Characteristics

Accuracy: $\pm 3\%$ of reading $\pm 3\%$ of range.

Calibrated electrical length, range, and resolution: (8660C/86602B/86632B or 8640): (8505A digital readouts $\times 1000$) give electrical length 1000 times larger and resolution divided by 1000.

General Characteristics

RF Inputs

L.O. drive input level: 10 dBm ± 2 dB (Rear panel BNC).

RF drive input level: 0 dBm ± 2 dB (Rear panel BNC).

Tunable FM output: ± 1.3 V maximum (rear panel BNC with output level controlled by $\pm \Delta F$ control on front panel of 8505A). ± 1.3 V output is obtained independent of the frequency range switch setting.

Capture range of phase-lock loop: 100 kHz (0.5-13 MHz Range); 400 kHz (0.5-130 MHz Range); 4 MHz (0.5-1300 MHz Range).

Standard/phase-lock operation: rear panel switch can disable all phase-lock circuitry when using the instrument in its standard (non phase-lock) operating mode.

¹Typical measurement Aperture using linear FM modulation technique.

²Vernier provides continuous adjustment of electrical length. Calibrated Electrical Length Linearity: $\Delta\phi = 0.7\% \times 1.2 f$ (MHz) $\times 1$ (meters).

NETWORK ANALYZERS

RF Network Analyzer: Storage Normalizer

Model 8501A

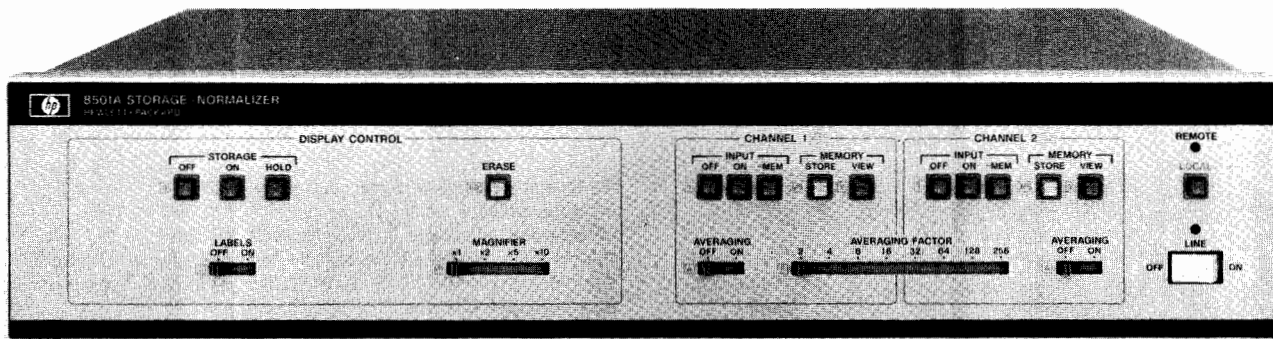

8501A



Description

The 8501A high performance Storage-Normalizer is a dedicated accessory that extends the measurement capability of your HP 8505A RF Network Analyzer (500 kHz to 1.3 GHz). Flicker free displays with digital storage and CRT annotation of major control settings provide convenient easy documentation. Using normalization, frequency response errors are simply removed. In addition the 8501A can digitally average signals to dramatically improve signal-to-noise ratios and magnify the display for high accuracy measurements. With a desktop computing controller, computer graphics capability is added to the 8505A for displaying corrected data, operator messages, or computer programs.

8501A Specifications

Display

Rectangular Displays

Horizontal display resolution: two display channels, 500 points per channel (0.2% of full scale, 0.24 mm).

Vertical display resolution: 500 points displayed full scale (0.2% of full scale) plus a 50% overrange (250 points) both above and below full screen.

Polar Displays

Display resolution: two display channels, 250 points per polar display (0.2% of full scale, 0.2 mm in X and Y).

Display tracking: visual offsets between direct 8505A and stored displays are approximately $\pm 1/2$ CRT minor division (± 1 mm).

Horizontal input sweep times: 100 sec max/10 ms min.

Conversion time: 10 ms max for 500 ± 2 data points (20 μ s per point).

Display refresh time: nominally 20 ms depending upon information displayed.

Line generator: a line generation technique is used to connect points on a CRT display, yielding a smooth continuous trace.

Markers: all five markers are also available in the digital display mode.

Output

Auxiliary outputs XYZ: (BNC female connectors on rear panel).

X—1 V full screen, 83 mV/div (12 div).

Y—1 V full screen, 100 mV/div (10 div).

Z—1 volt blanks display, +2 volt unblanks display. (Signal compatible for all HP CRT displays such as 1332, 1304, or 1310).

Offsets: the X, Y, and polar display offsets can be adjusted over a $\pm 10\%$ range of screen by means of potentiometers on the rear panel of the 8501A.

Labeling interface: all major control settings of the 8505A and 8503A and phase-lock indication are displayed on the CRT.

HP-IB Interface

HP-IB Interface Capabilities

Remote Programming

Learn mode: this feature provides the ability to output the current instrument state to a computing controller.

Input data: data for graphics or other purposes can be sent to the 8501A at a rate of:

ASCII mode: 600 points per second.

Binary mode: 10000 points per second.

Output data: data can be read from the 8501A at a rate of:

ASCII mode: 800 points per second.

Binary mode: 9000 points per second.

Graphics: data for graphics can be read into the 8501A and viewed in two types of displays.

Text displays: 22 lines of text with 54 characters per line can be displayed on the CRT.

Vector display: lines can be drawn on the display between any two points with a resolution of 432 points in X and 360 points in Y (nominal).

General

Display Controls

Storage off: the 8501A is bypassed so the display returns to normal analog operation.

Storage on: turns on digitally stored display.

Storage hold: the current display is not updated and is frozen for CRT photography or further analysis.

Erase: display and memory are erased.

Labels: switches all display labeling on or off.

Magnifier: expands the display by a factor of 1, 2, 5, or 10.

Processing Functions (channel 1 and 2)

Input off: display of channel 1 (2) is blanked.

Input on: channel 1 (2) measurement is displayed.

Input mem: the difference between the channel 1 (2) measurement and the stored memory content is displayed (normalization).

Memory store: the current measurement is stored in memory.

Memory view: the stored memory content is displayed.

Averaging: the data averaging function for channel 1 (2) is switched on or off.

Averaging factor: the degree of averaging is selectable from 2, 4, 8 ... to 256. The current averaged trace is always displayed and updated at the sweep rate.

Local: returns the 8501A control to the front panel from remote HP-IB control.

Includes: 0.5 m HP-IB cable and the processor interconnect cable.

Accessories: the 11864A Accessory Kit provides the labeling interface boards and connectors for retrofitting the 8505A. Labeling interface now standard on the 8505A.

Power: selection of 100, 120, 220, or 240 V +5%–10%, 50 to 60 Hz and <140 VA (<140 watts).

Size: 90 H x 426 W x 534 mm D (3.5" x 16.75" x 21.0").

Weight: net, 12.25 kg (27 lb). Shipping, 14 kg (31 lb).



NETWORK ANALYZERS

RF Network Analyzer, 500 kHz to 1.3 GHz (cont.)

Models 8503A/B, 8502A/B, 11850A/B, 11851A-11858A, 11857B

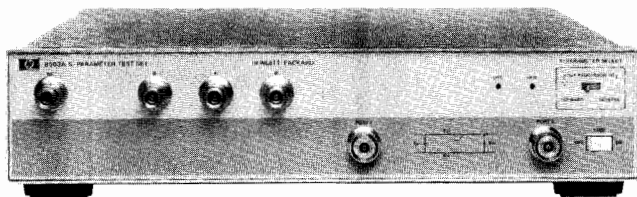

8503A

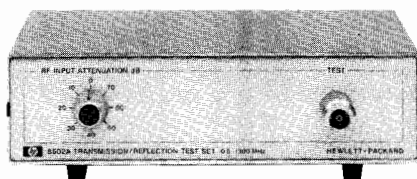

8502A

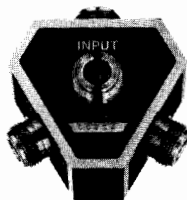

11850A

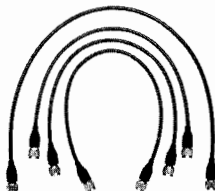

11851A

8502A 50 Ω Transmission/Reflection Test Set 8502B 75 Ω Transmission/Reflection Test Set

Frequency range: 500 kHz to 1.3 GHz.

Impedance: 8502A, 50 Ω ; 8502B 75 Ω .

Directivity: ≥ 40 dB.

Frequency Response

Transmission: $\leq \pm 0.8$ dB and $\leq \pm 8^\circ$.

Reflection: $\leq \pm 1.5$ dB and $\leq 15^\circ$ from 0.5–1300 MHz; $\leq \pm 10^\circ$ from 2–1300 MHz.

Port Match

Test port: ≥ 26 dB return loss from 2–1300 MHz (≥ 24 dB for 8502B); ≥ 20 dB return loss from 0.5–2 MHz (≥ 18 dB for 8502B).

Test port open/short ratio: ± 0.75 dB and $\pm 6^\circ$ from 2–1000 MHz (± 0.9 dB and $\pm 7.5^\circ$ for 8502B); ± 0.9 dB and $\pm 7.5^\circ$ from 1000–1300 MHz; ± 1.25 dB and $\pm 10^\circ$ from 0.5–2 MHz.

Reference and reflection ports: ≥ 25 dB return loss from 2–1000 MHz; ≥ 23 dB return loss from 0.5–1300 MHz.

Input port: ≥ 23 dB return loss.

Nominal Insertion Loss

Input to test port: 13 dB (8502A), 19 dB (8502B).

Input to reference port: 19 dB (8502A), 19 dB (8502B).

Input to reflection port: 19 dB (8502A), 31 dB (8502B).

Maximum operating level: +20 dBm.

Damage level: 1 watt CW.

RF attenuator range: 0 to 70 dB in 10-dB steps.

Connectors test port: 50 Ω Type N Female for 8502A and 75 Ω Type N Female for 8502B; all other RF ports 50 Ω Type N Female; Bias input, BNC Female.

DC bias input: ± 30 V dc and ± 200 mA.

Includes: 8502B includes 50 Ω /75 Ω minimum loss pad.

Recommended accessory: 11851A RF Cable Kit for either 8502A or 8502B.

Size: 61.5 H x 101 W x 204 mm D (2.44" x 7.5" x 8.0").

Weight: net, 1.7 kg (3.25 lb). Shipping, 3.1 kg (7 lb).

8503A 50 Ω S-Parameter Test Set

8503B 75 Ω S-Parameter Test Set

Frequency range: 500 kHz to 1.3 GHz.

Impedance: 8503A, 50 Ω ; 8503B, 75 Ω .

Directivity: ≥ 40 dB.

Frequency Response

Transmission (S_{12} , S_{21}): ± 1 dB, $\pm 12^\circ$ from 0.5–1300 MHz.

Reflection (S_{11} , S_{22}): ± 2 dB, $\pm 20^\circ$ from 0.5–1300 MHz; $\pm 15^\circ$ from 2–1300 MHz.

Port Match

Test ports 1 and 2: ≥ 26 dB return loss from 2–1300 MHz (≥ 24 dB for 8503B), ≥ 20 dB return loss from 0.5–2 MHz (≥ 18 dB for 8503B).

Test port 1 and 2 open/short ratio: $\leq \pm 0.75$ dB and $\pm 6^\circ$ from 2–1000 MHz (± 0.9 dB and $\pm 7.5^\circ$ for 8503B); $\leq \pm 0.9$ dB and 7.5° from 1000–1300 MHz; ± 1.25 dB and $\pm 10^\circ$ from 0.5–2 MHz.

Reference and return ports: ≥ 23 dB return loss from 2–1000 MHz; ≥ 20 dB return loss from 0.5–2 MHz and 1000–1300 MHz.

RF input port: 20 dB return loss from 0.5–1300 MHz.

Maximum operating level: +20 dBm.

Damage level: 1 watt CW.

Connectors: test ports, 50 Ω APC-7 for 8503A and 75 Ω Type-N Female for 8503B; all other RF connectors, 50 Ω Type-N Female; Bias inputs BNC Female.

DC bias input: 30 V dc, ± 200 mA.

Includes: four 19 cm (7.5") cables for connection to 8505A.

Recommended accessory: 11857A 50 Ω Test Port Extension Cables or 11857B/C 75 Ω Test Port Extension Cables.

Programming: programming via HP-IB. 0.5 m HP-IB cable included.

Power: 100, 120, 220, or 240 V +5%–10%, 50 or 60 Hz. Approx. 10 watts (15 watts for 8503B).

Size: 90 H x 426 W x 553 mm D (3.5" x 16.75" x 21.0").

Weight: net, 9.1 kg (20 lb). Shipping, 11.3 kg (25 lb).

Accessories

11850A 50 Ω Power Splitter

11850B 75 Ω Power Splitter

Frequency range: dc to 1.3 GHz.

Impedance: 11850A, 50 Ω ; 11850B, 75 Ω .

Tracking between any two output ports: ≤ 0.1 dB and $\leq 1.5^\circ$.

Equivalent source match (ratio or leveling): ≥ 32 dB return loss (≤ 1.05 SWR).

Input port match: ≥ 20 dB return loss.

Nominal insertion loss: 9.54 dB for 11850A; 7.78 dB for 11850B.

Frequency response absolute: input to Output ≤ 0.2 dB.

Maximum operating level: +20 dBm.

Burn-out level: ≥ 1 watt CW.

Connectors: 11850A, 50 Ω Type N female; 11850B, three outputs 75 Ω Type N female, RF input 50 Ω Type N female.

Recommended accessory: 11851A RF Cable Kit.

Includes: 11850B includes three (3) 50 Ω /75 Ω Minimum Loss Pads

Size: 46 H x 67 W x 67 mm D (1.88" x 2.63" x 2.63").

Weight: net, 1.8 kg (4 lb). Shipping, 3.1 kg (7 lb).



11851A RF Cable Kit

General: three 610 mm (24 in.) 50 Ω cables phase matched to 4° at 1.3 GHz and one cable 860 mm (34 in.). Connectors are Type N Male. Recommended for use with 8502A/B Transmission/Reflection Test Set and 11850A/B Power Splitter.

Weight: net, 0.91 kg (2 lb). Shipping, 1.36 kg (3 lb)

11852A 50 Ω /75 Ω Minimum Loss Pad

General: the 11852A is a low SWR minimum loss pad required for transmission measurements on 75 Ω devices with 8505A receiver (50 Ω).

Frequency range: dc to 1.3 GHz.

Insertion loss: 5.7 dB.

Return loss: 75 Ω side, 50 Ω side terminated: Typically ≥ 34 dB (≤ 1.04 SWR). 50 Ω side, 75 Ω side terminated: Typically ≥ 30 dB (≤ 1.06 SWR).

Typical flatness: ≤ 0.1 dB from DC to 1.3 GHz.

Maximum input power: 250 mW (+24 dBm).

Connectors: 50 Ω Type N female and 75 Ω Type N male.

Size: 14 D x 70 mm L (0.56" x 2.75").

Weight: net, 0.11 kg (4 oz). Shipping, 0.26 kg (9 oz).

11853A 50 Ω Type N Accessory Kit

General: the 11853A furnishes the RF components required for measurement of devices with 50 Type N Connectors using the 11850A, 8502A, or 8503A (8503A also requires the 85032A). Kit contains a Type N Female short, a Type N Male short, two Type N Male barrels, two Type N Female barrels and storage case.

Weight: net, 0.91 kg (2 lb). Shipping, 1.36 kg (3 lb).

11854A 50 Ω BNC Accessory Kit

General: the 11854A furnishes the RF components required for measurement of devices with 50 BNC Connectors using the 11850A, 8502A, or 8503A (8503A also requires the 85032A). Kit contains two Type N Male to BNC Female adapters, two Type N Male to BNC Male adapters, two Type N Female to BNC Female adapters, two Type N Female to BNC Male adapters, a BNC Male short and storage case.

Weight: net, 1.13 kg (2½ lb).

11855A 75 Ω Type N Accessory Kit

General: the 11855A provides the RF connecting hardware generally required for measurement of devices with 75 Ω Type N connectors using the 8502B, 8503B or 11850B. Kit contains two 75 Ω Type N Male barrels, two Type N Female barrels, a 75 Ω Type N Female short, a 75 Ω Type N Male short, a 75 Ω Type N Male termination, and storage case.

Weight: net, 0.91 kg (2 lb). Shipping, 1.36 kg (3 lb).

11856A 75 Ω BNC Accessory Kit

General: the 11856A provides the RF connecting hardware generally required for measurement of devices with 75 Ω BNC connectors using the 8502B, 11850B, or 8503B. Kit contains two Type N Male to BNC Female adapters, two Type N Male to BNC Male adapters, two Type N Female to BNC Female adapters, two Type N Female to BNC Male adapters, a BNC Male short, a 75 Ω BNC Male termination, and storage case.

Weight: net, 0.91 kg (2 lb). Shipping, 1.36 kg (3 lb).

11857A 50 Ω APC-7 Test Port Extension Cables

General: two precision 61 cm (24 in.) cables, phase matched to 2° at 1.3 GHz for use with 8503A S-parameter test set. Connectors are 50 Ω APC-7.

Weight: net, 0.91 kg (2 lb). Shipping, 2.3 kg (5 lb).

11857B 75 Ω Type N Test Port Extension Cables

General: two precision 61 cm (24 in.) cables, phase matched to 2° at 1.3 GHz for use with 8503B S-parameter test set. One cable has 75 Ω Type N Male connectors on both ends; the other has one Type N Male and one Type N Female connector.

Weight: net, 0.91 kg (2 lb). Shipping, 2.3 kg (5 lb).

11858A Transistor Fixture Adapter

General: the 11858A adapts the 11600B and 11602B transistor Fixtures (vertical test port configuration) to the 8503A S-parameter test set. Connectors are APC-7.

Weight: net, 0.91 kg (2 lb). Shipping, 1.36 kg (3 lb).

Ordering Information

8505A* RF Network Analyzer

Opt 005: Phase Lock

Opt 908: Rack Mounting Kit (for use without front handles)

Opt 910: Extra Manual

Opt 913: Rack Mounting Kit

8503A* 50 Ω S-Parameter Test Set

Opt 908: Rack Mounting Kit (for use without front handles)

Opt 910: Extra Manuals

Opt 913: Rack Mounting Kit

8503B* 75 Ω S-Parameter Test Set

Opt 908: Rack Mounting Kit (for use without front handles)

Opt 910: Extra Manual

Opt 913: Rack Mounting Kit

8501A* Storage Normalizer

Opt 908: Rack Mounting Kit (for use without front handles)

Opt 910: Extra Manual

Opt 913: Rack Mounting Kit

8502A 50 Ω Transmission/Reflection Test Set

Opt 910: Extra Manual

8502B 75 Ω Transmission/Reflection Test Set

Opt 910: Extra Manual

11850A 50 Ω Power Splitter

11850B 75 Ω Power Splitter

11851A RF Cable Kit

11852A 50 Ω to 75 Ω Minimum Loss Pad

11853A 50 Ω Type N Accessory Kit

11854A 50 Ω BNC Accessory Kit

11855A 75 Ω Type N Accessory Kit

11856A 75 Ω BNC Accessory Kit

11857A 50 Ω APC-7 Test Port Extension Cables

11857B 75 Ω Type N Test Port Extension Cables

11858A Transistor Fixture Adapter

11864A Labeling Interface Kit

*Front Handles are Standard



NETWORK ANALYZERS

Automatic Network Analyzer System, 500 kHz to 1.3 GHz

Model 8507S

- Improve productivity in lab and factory
- Accuracy enhancement
- Ease of operation via HP-IB
- 9816S, 9826S or 9836 Computer
- Learn mode
- Graphics transfer to computer

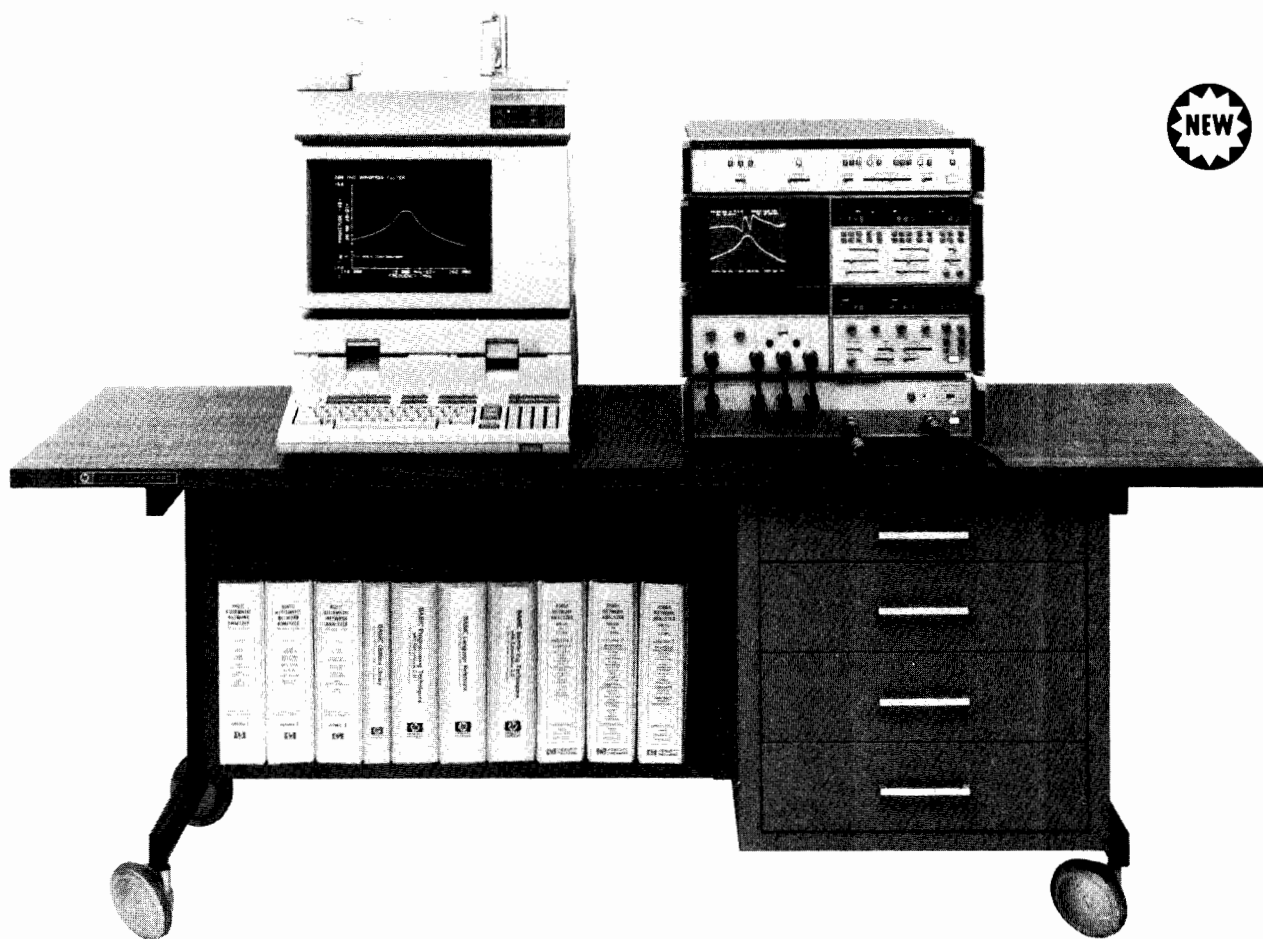

8507S



Description

The 8507S is an Automatic Network Analyzer System based on the 8505A Network Analyzer that is controlled by one of the Series 200 computers (9816, 9826S, or 9836S). Mating this versatile, easy-to-use desktop computer with the completely programmable network analyzer produces a powerful RF network measurement tool for both lab and production use.

Cost Effective Solutions

In laboratory applications, engineers gain greater circuit insight via the speed and ease with which the 8507S accumulates and summarizes data. Use the 85011A Software for accuracy enhancement and data output formatting or program the instruments yourself with easy-to-use HP-IB commands. With only a few hours training, engineers with no previous programming experience have been able to write customized programs that solve specialized measurement problems. In production environments, the 8507S can dramatically reduce the time and cost of making complicated limit tests on all types of components. Testing programs with built-in operator instructions can minimize training cost, assure uniform test procedures and eliminate subjective decisions.

Simplicity and Flexibility of HP-IB

Configuration of the standard 8507S is a simple matter since it is programmed via the Hewlett-Packard Interface Bus. For example, perhaps your RF measurement application requires a programmable power supply for transistor biasing or a digital voltmeter. Simply choose an instrument from the selection of HP-IB programmable instruments and add it to your 8507S using universal HP-IB cables.

It is equally easy to get started making measurements since the 8507S comes with software (85011A) that complements the Hewlett-Packard hardware. Included are programs for 8 or 12 term accuracy enhancement and general network analyzer applications. In addition, a system check-out program is provided.

Learn Mode Operation

The "Learn" mode of operation has extended traditional automatic operation to a new level of operator convenience. The desktop computer can accept (Learn) a data string from the network analyzer that defines all of the manually set front panel control settings. This is accomplished by a single keystroke. Once stored in the desktop computer (or permanently recorded on a flexible disc) this data string can then be used to automatically return the network analyzer to its exact original test conditions. And this can all be done without the operator ever writing a single program line!

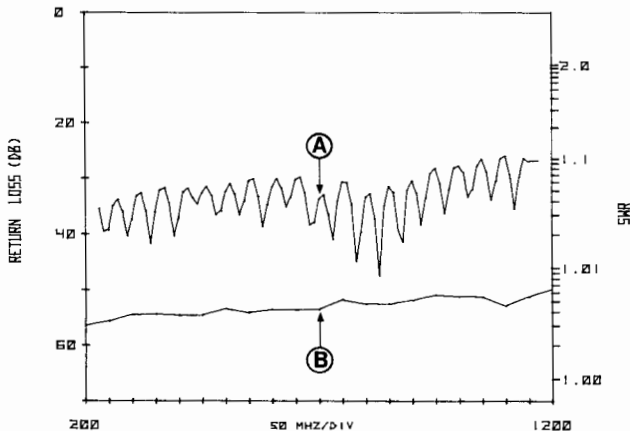

Accuracy Enhancement

The 85011A System Software permits frequency tracking, mismatch, and directivity errors to be characterized by applying known standards. These stored system errors are then removed from the measurement of the unknown to provide a degree of accuracy exceeding that possible with the standard 8505A.

An Example

The plots on the left show the result of software accuracy enhancement. Curve A depicts raw measurements on a 50 dB return loss termination at the end of a six-foot RG 214 cable—a typical application problem in testing in temperature chambers. Curve B shows the results after calibrating at the end of the cable—a 25 dB improvement.

Data in the Form you Need

With the desktop computers, it is a simple matter to obtain customized printed or plotted outputs. Or you may want to store data on tape for later analysis. Data can be analyzed or statistically summarized directly, bypassing the laborious and error-prone task of manually recording and re-entering data. Data reformatting such as converting return loss to SWR or S-parameters to Y-parameters can be accomplished also.

8507S Automatic Network Analyzer

Ordering Information

System Reference

8507S Automatic Network Analyzer

This system reference number ensures coordinated delivery and compatibility of instrument and software

Network Analyzer Subsystem

8507D Network Analyzer Subsystem

Includes: 8505A Network Analyzer
8501A Storage Normalizer
8503A S-Parameter Test Set
85031A APC-7 Calibration Kit
Systems Table and Cables
System Assembly and Checkout

- Opt. 002: Delete Systems Table
- Opt. 005: Add 8505A Phase Lock
- Opt. 910: Extra Set of Manuals
- Opt. 913: Rack Mounting Kit

Calibration Kits

85031A APC-7 Calibration Kit (included with 8507D)

85032A 50 Ω Type-N Calibration Kit

85033A SMA Calibration Kit

85036A 75 Ω Type-N Calibration Kit

Computers (choose one)

9816S Series 200, Model 16S Computer (select option)

Opt. 630 for use with 9121D Disk Drive

Opt. 650 for use with 82901M Disk Drive

9826S Series 200, Model 26S Computer

9836S Series 200, Model 36S Computer

Disk Drives (one required for 9816S)

9121D 3.5 inch Dual Flexible Disk Drive

82901M 5.25 inch Dual Flexible Disk Drive

Software (choose one option)

85011A System Software for 8507D

Opt. 630 for 9816S Computer with 9121D Disk Drive

Opt. 650 for 9816S Computer with 82901M Disk Drive

Opt. 655 for either 9826S or 9836S Computer

Printer (choose one)

2673A Thermal Graphics Printer

2932A Impact Graphics Printer

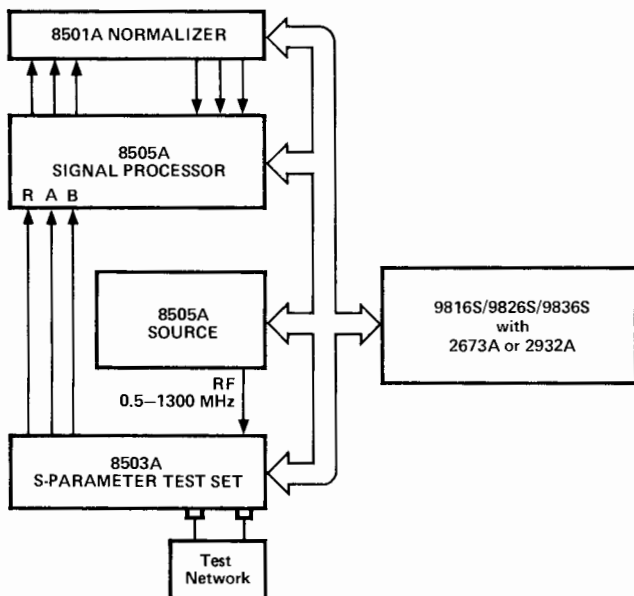

8507S Calibration Kits

85031A Verification and APC-7 Calibration Kits

Included with 8507D. Contains Precision APC-7 Load, APC-7 Short, and two verification standards.

85032A Type N Calibration Kit

For use with 8507S. Contains 2 APC-7 to N-Male Adapters, 2 APC-7 to N-Female Adapters, 1 N-Male Load, 1 N-Female Load, 1 N-Female Short, 1 N-Male Short.

85033A SMA Calibration Kit

For use with 8507S. Contains 2 APC-7 to SMA-Male Adapters, 2 APC-7 to SMA-Female Adapters, 1 SMA-Male Load, 1 SMA-Female Load, 1 SMA-Female Short, and 1 SMA-Male Short.

85036A 75 Ω Type N Calibration Kit

For use with the 8507S Opt E75 75 Ω Automatic Network Analyzer. Contains 1 Type N Male Termination, 1 Type N Female Termination, 1 Type N Male Short, 1 Type N Female Short, 1 Type N Male Barrel, and 1 Type N Female Barrel.



NETWORK ANALYZERS

RF Network Analyzer, 100 kHz to 110 MHz

Model 8407 Series

- Complete swept characterization of linear networks
- Modular system flexibility
- 50 Ω and 75 Ω measurements
- Digital storage

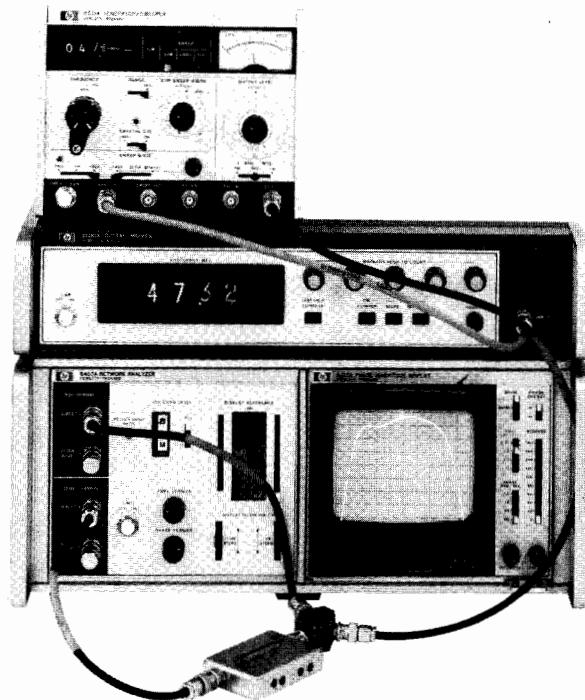

Swept measurements for either designing or testing are made with ease by HP's versatile 8407 Network Analyzer System. Since phase as well as magnitude is measured by this Network Analyzer, the behavior of both active and passive linear networks can be completely characterized from 100 kHz to 110 MHz by swept measurement.

Measurements of gain, loss, phase shift (compute a group delay), return loss, and complex reflection coefficient are all possible in either 50 Ω or 75 Ω systems. These measurements allow the linear behavior of the networks under test to be completely characterized by their complex S-Parameters. Swept complex impedance [Z] and θ as well as voltage and current transfer functions are also measured quickly and easily by the 8407 system. Typical linear networks designed and tested with the 8407 are filters, amplifiers, attenuators, antennas, detectors, cables, and recording heads.

Much of the 8407's versatility stems from its modular construction which allows the system to perform a variety of measurements or be economically tailored to one application. The basic instruments of the 8407 system are: The HP 8407A Network Analyzer, HP 8601A Sweeper/Generator, choice of two plug-in displays (HP 8412B Phase-Magnitude Display or HP 8414B Polar Display), an optional digital marker (HP 8600A), and one of the transducers (HP 11652A, or 1121A) depending on the measurement. Because the 8407A is a tracking receiver, the HP 8601A is the only source providing the VTO output required to operate the network analyzer. Thus, an operating system must be configured with the required source, the network analyzer, a display and one or more of the transducers depending on the device under test and the network parameters desired.

Specifications

8407A

General: 8407A is a two input tracking receiver, using both inputs (reference and test channels) to form their magnitude ratio and phase difference before routing to display.

Frequency range: 0.1–110 MHz.

Impedance: 50 Ω , SWR < 1.08; Option 008: 75 Ω , SWR < 1.08.

Dynamic range: 80 dB.

Test input: DIRECT –10 to –90 dBm signal range. ATTENUATED, +20 to –50 dBm signal range. Damage level +26 dBm/50 V dc.

Reference input: DIRECT level required, –10 to –60 dBm. ATTENUATED level required +20 to –20 dBm. Damage level +26 dBm/50 V dc.

Amplitude accuracy: FREQUENCY RESPONSE ± 0.2 dB for DIRECT input (test input > –60 dBm), 0.1–110 MHz; ± 0.05 dB over any 10 MHz portion; may be calibrated out. Typically ± 0.05 dB for DIRECT inputs (REFERENCE level of –10 dBm). DISPLAY REFERENCE, <0.05 dB/1 dB step, total error ≤ 0.1 dB; <0.1 dB/10 dB step, total error ≤ 0.25 dB. ATTENUATED INPUTS, 40 dB ± 0.5 dB. REFERENCE CHANNEL GAIN CONTROL, 20 dB and 40 dB steps ± 0.5 dB/step. CROSSTALK, <0.03 dB when test/ref = –40 dB to <4 dB when test/ref = –80 dB.

Power: 65 watts, 50–60 Hz, 115/230 $\pm 10\%$ V ac.

Weight: net, 14.6 kg (32 lb). Shipping, 17.8 kg (39 lb).

8412B

General: plug-in PHASE-MAGNITUDE CRT Display. Displays magnitude and/or phase vs. frequency.

Amplitude accuracy: display, 0.08 dB/dB from midscreen. Rear output: 0.03 dB/dB variation from 0 volt output.

Phase accuracy: DISPLAY, 0.065°/degree from midscreen. PHASE OFFSET, 0.3°/20° step, $\leq 3^\circ$ for 360° change, positive or negative direction. VS. DISPLAYED AMPLITUDE, <1°/10 dB; total <6° over 80 dB range.

Rear panel inputs: sweeping, ≤ 15 V dc. Blanking, –4 V dc blanks CRT. Z axis (marker), –5 V dc intensifies and +5 V dc blanks trace.

Power: 23 watts, supplied by 8407A.

Weight: net, 7.8 kg (17 lb). Shipping, 10 kg (22 lb).

Detailed Specifications on page 459.

8750A

General: the 8750A Storage-Normalizer provides digitally stored and normalized CRT displays when used with the 8412A Phase-Magnitude Display. Measurements are faster, easier, and more accurate when the 8750A is employed because the CRT is flicker-free and frequency response errors are eliminated. The 8750A is not compatible with the 8414A Polar Display.

Power: selection of 100, 120, 220, or 240 V +5%–10%, 48 to 440 Hz and ≤ 20 VA (≤ 20 watts).

Weight: net, 2.72 kg (6 lbs). Shipping, 5.0 kg (11 lbs).

Detailed Specifications on page 468.

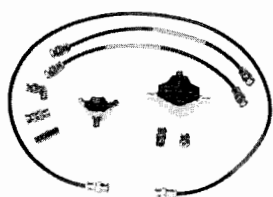

11652A



1121A

8414B

General: normalized POLAR coordinate display with magnitude calibration in 0.2 of full scale gradations. Full scale is determined by DISPLAY REFERENCE on 8407A; phase calibration is in 10° increments over 360° range. Smith Chart overlays available.

Accuracy: all errors in amplitude and phase due to display are contained within a circle of 3mm about measurement point.

Rear panel inputs: blanking, -4 to -10 V dc blanks CRT. Marker, intensified trace with -4 to -10 V dc.

Rear panel outputs: horizontal and vertical both ± 2.5 V for full scale deflection.

Power: 35 watts, supplied by 8407A.

Weight: net, 5.9 kg (13 lb). Shipping, 8.0 kg (18 lb).

Detailed specifications on page 459.

8601A

General: GENERATOR/SWEEPER operating in either CW or SWEPT modes. Sweep modes are full, variable stop frequency, and symmetrical (up to 10 MHz). Features very low residual FM, spurious, harmonics, and drift. 8601A provides the VTO signal required to operate the 8407A.

Frequency: 0.1-11 MHz in two sweep ranges, 0.1-11 MHz and 1-110 MHz.

Impedance: 50 Ω VSWR < 1.2. Option 008: 75 Ω . VSWR < 1.2.

Accuracy: 1% of frequency, 0.5% linearity, and 2% of sweep width.

Calibrated output: ± 0.25 dB flatness over full range, output accuracy ± 1 dBm from +10 to -110 dBm.

Auxiliary outputs: sweep out, blanking (for 8412 and 8414), VTO (required by 8407A), and auxiliary output (0.1-11 MHz both ranges) for 8600 counter/digital marker.

Detailed specifications on page 371.

8600A

General: DIGITAL MARKER used with 8601A generator/sweeper to provide five continuously variable markers on a display while reading out the frequency of any one marker. Six digit display.

Markers/accuracy: 5 markers accurate at desired frequency \pm (0.05% sweep width + sweep stability).

Counter frequency range: 0.1-15 MHz (automatically scales up by ten when 8601A on 0.1-110 MHz range).

Detailed specifications on page 371.

11652A

General: REFLECTION-TRANSMISSION KIT containing power splitter, 8721A DIRECTIONAL BRIDGE, precision termination, calibrating short, three BNC adapters, and four matched, low-leakage cables for both transmission and reflection measurements. All 50 Ω BNC connectors, Option 008 75 Ω .

Directional bridge: 8721A: 6 dB insertion loss and 6 dB coupled to auxiliary arm. Frequency response ± 0.5 dB (0.1-110 MHz). Directivity > 40 dB (1 to 110 MHz). Load port return loss > 30 dB ($\rho < 0.03$). Max input power + 20 dBm. 50 Ω , Option 008: 75 Ω .

Power splitter: 6 dB through each arm. Max input power + 20 dBm. 50 Ω .

50 Ω termination: return loss > 43 dB.

Weight: net, 0.7 kg (1.5 lb). Shipping, 1.2 kg (2.5 lb).

11658A

General: 50 Ω to 75 Ω matching resistor for matching the 50 Ω of the 8407A to a 75 Ω environment. Two 11658A's are very useful for frequent 50 Ω to 75 Ω changes. The 11658A's mount directly on the front panel, of 8407A, FREQUENCY, 0.1-110 MHz. INSERTION LOSS, 3.5 dB. RETURN LOSS, > 40 dB. CONNECTORS, 50 Ω BNC male and 75 Ω BNC female.

Net weight: 28 g (1 oz).

1121A

General: 1:1 active probe for making measurements without disturbing circuitry and measuring voltage transfer functions in systems different from 50 Ω . 10:1 and 100:1 dividers and BNC adapter also furnished.

Frequency response: ± 0.5 dB and $\pm 2\%$ from 0.1-110 MHz with a bandwidth (3 dB) of 1 kHz to > 500 MHz and gain 0 dB ± 1 dB.

Input impedance: 100 k Ω , shunt capacitance of 3 PF at 100 MHz. With 10:1 or 100:1 divider, 1 M Ω , shunt capacitance 1 PF at 100 MHz.

Output impedance: 50 Ω nominal.

Maximum input: 300 mV rms, +80 V dc; with 10:1 divider, 30 V rms, ± 350 V dc.

Power: supplied by 8407A through PROBE PWR jacks.

Weight: net, 0.7 kg (1.5 lb). Shipping, 1.2 kg (2.5 lb).

Ordering Information

8407A Network Analyzer

Opt 008: 75 Ω input

8412B Phase Magnitude Display

8750A Storage-Normalizer

8414B Polar Display

8601A Sweeper/Generator

Opt 008: 75 Ω output

8600A Digital Marker

11652A Reflection/Transmission Kit (50 Ω)

Opt 008: 75 Ω

11658A Matching Resistor

1121A AC Probe Kit

8721A Directional Bridge (50 Ω)

Opt 008: 75 Ω

NETWORK ANALYZERS

Microwave Network Analyzer, 110 MHz to 40 GHz
8410 Series

- Complete microwave measurement systems
- Measures all network parameters
- Multioctave swept frequency measurements
- Eliminate harmonic and spurious responses

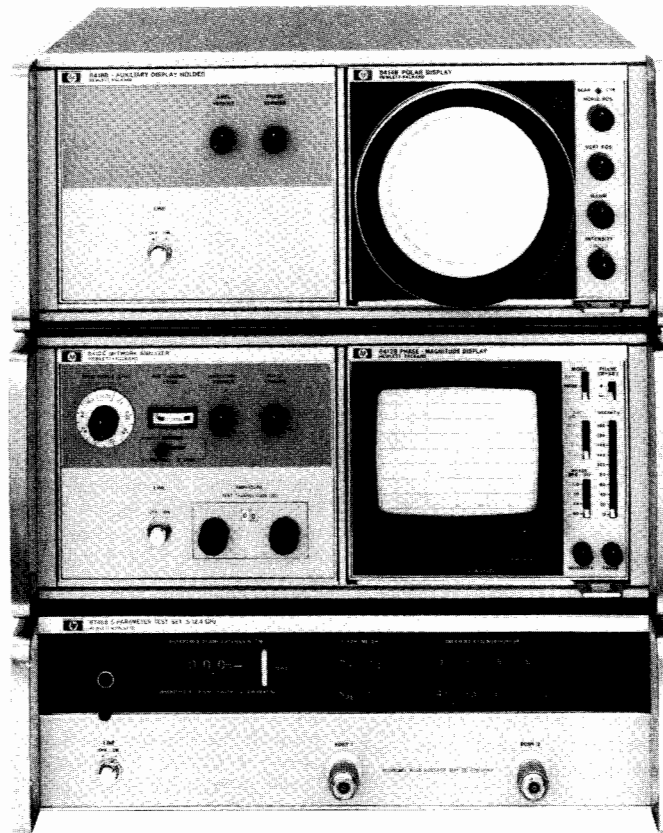

Receiver

- 8410C Network Analyzer
- 8411A Harmonic Frequency Converter
- Opt 018 Operation to 18 GHz

Displays

- 8412B Phase/Magnitude Display
- 8418B Auxiliary Display Holder
- 8414B Polar Display

Test Set

- 8746B S-Parameter Test Set

General

This configuration is the basis for the high performance 8409-series automatic network analyzer described on page 467. This building-block approach to system configuration allows HP-IB accessories such as an A/D converter and relay switching instruments to be added to a manual system to allow upgrading to fully automatic applications. Refer to HP application note AN 221A for information on automating the 8410C Microwave Network Analyzer.

Receiver

The 8410C Network Analyzer and 8411A Harmonic Frequency Converter comprise the nucleus of the swept-frequency system which provides magnitude and phase measurement capability from 110 MHz to 18 GHz in coax and 12.4 to 40 GHz in waveguide. Automatic frequency locking allows continuous multioctave sweeps. Frequency conversion from RF to IF gives high sensitivity and greater than 60 dB dynamic range, free of spurious and harmonic responses. Calibrated IF substitution makes possible accurate gain or insertion loss measurements.

Displays

The 8412B Phase/Magnitude Display displays magnitude and phase versus frequency. The 8414B Polar Display provides a polar plot of magnitude and phase. These displays are interchangeable plug-ins for the 8410C mainframe. The 8418B Auxiliary Display Unit can be added to provide simultaneous rectilinear and polar display capability.

Sources

Although the 8410C can produce octave-width sweeps using any swept source, continuous multi-octave sweeps limited only by the frequency range of the test set are possible with the 8620C or 8350A Sweep Oscillators.

Test Sets

The 8745A, 8743B, and 8746B test sets contain all necessary splitters and couplers required to provide stimulus to the device under test and route the reference and reflected or transmitted signals to the receiver. Accessories allow the test sets to be configured for active and passive coaxial measurements as well as for semiconductor measurement applications.

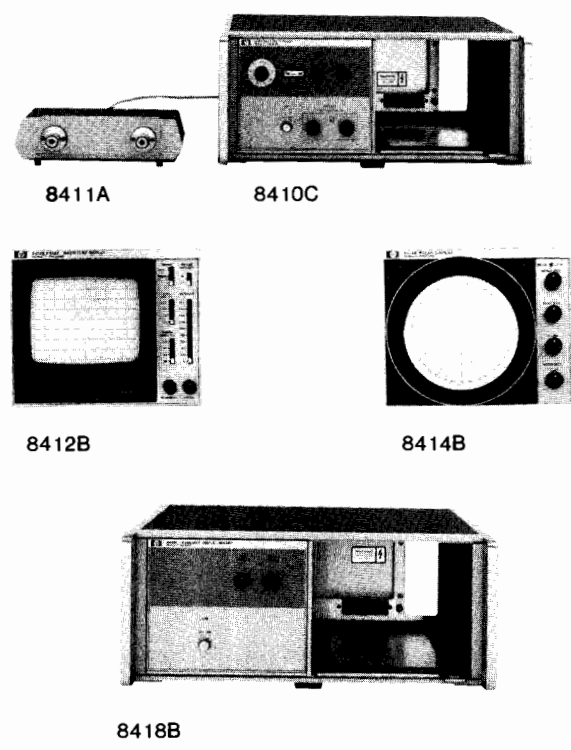

Phase

Phase range: 0 to 360°
Control: vernier control $\leq 90^\circ$
Connectors (8411A): APC-7.
Power: 115 or 230 V $\pm 10\%$, 50-60 Hz, 70 watts (includes 8411A).
Weight
8410C: net, 14.9 kg (33 lb). Shipping, 18.5 kg (41 lb).
8411A: net, 3.2 kg (7 lb). Shipping, 4.5 kg (10 lb).
Size
8410C: 191 H x 425 W x 467 mm D (7.5" x 16.75" x 18.38").
8411A: 67 x 228 W x 143 mm D (2.63" x 9" x 5.63") exclusive of connectors and cable.

8412B Phase-Magnitude Display

Function: plug in CRT display unit for 8410C. Displays relative amplitude in dB and/or relative phase in degrees between reference and test channel inputs versus frequency. Programmable 180° phase offset by ground closure.

Amplitude

Range: 80 dB display range with selectable resolutions of 10, 2.5, 1 and 0.25 dB/division.
Accuracy: 0.08 dB/dB from midscreen.

Phase

Range: $\pm 180^\circ$ display range with selectable resolutions of 90, 45, 10, and 1°/division.
Accuracy: 0.065°/degree from midscreen.
Phase offset: 0.3°/20° step cumulative $< 3^\circ$.
Power: 23 watts supplied by mainframe.
Weight: net, 7.8 kg (17 lb). Shipping, 10 kg (22 lb).
Size: 152 H x 186 W x 395 mm D (6" x 7.28" x 15.56") excluding front panel knobs.

8414B Polar Display

Function: plug-in CRT display unit for 8410C. Displays amplitude and phase data in polar coordinates on 5-in. cathode ray tube.
Range: normalized polar coordinate display; magnitude calibration 20% of full scale per division. Scale factor is a function of IF setting on 8410C. The beam center function is controllable by an external contact closure.
Accuracy: error circle on CRT ± 3 mm.
Power: 35 watts supplied by mainframe.
Weight: net, 5.8 kg (13 lb). Shipping 8.1 kg (18 lb).
Size: 152 H x 186 W x 395 mm D (6" x 7.28" x 15.56") excluding front panel knobs.

8418B Auxiliary Display Holder

Function: the 8418B Auxiliary Display Holder provides power for operating of the 8412B, 8413A or the 8414B display units. Used in conjunction with the 8410C Network Analyzer, it provides the capability of viewing amplitude and phase readout in both rectangular and polar coordinates simultaneously. Includes a remotely programmable 0-70 dB IF attenuator required for autoranging in automatic applications.
Weight: net, 11.2 kg (25 lb). Shipping, 19.7 kg (44 lb).
Size: 177 H x 483 W x 450 mm D (6.97" x 19" x 17.13").

Ordering Information

- 8410C mainframe
- Opt 908: Rack Flange Kit
- 8411A Frequency Converter
- Opt 018: 0.11 to 18 GHz
- 8412B Phase-Magnitude Display
- 8414B Polar Display
- 8418B Auxiliary Display Holder
- Opt 908: Rack Flange Kit

Specifications

8410C/8411A Network Analyzer

Function: 8411A converts RF signals to IF signals for processing in 8410C mainframe. 8410C is the mainframe for display plug-in units. Mainframe includes tuning circuits (octave bands or multioctave bands when used with HP 8620C or 8350A sweep oscillator), IF amplifiers and precision IF attenuator. 8410C allows injection of an external local oscillator used in automatic applications to lock the 8410C receiver to an external source such as the HP 3335A.

8410C frequency range: 0.11 to 18 GHz.
8411A frequency range: 0.11 to 12.4 GHz.
Opt 018: 0.11 to 18 GHz.
8411A input impedance: 50 ohms nominal. SWR < 1.5 , 0.11 to 2.0 GHz; < 2.0 , 2.0 to 16.0 GHz; 3, 6.0 to 18.0 GHz.
Channel isolation: > 65 dB, 0.1 to 6 GHz; > 60 dB, 6 to 12.4 GHz; > 50 dB, 12.4 to 18 GHz.

Magnitude Range

Reference channel: -18 to -35 dBm, 0.11 to 12.4 GHz; -18 to -25 dBm from 12.4 to 18.0 GHz.
Test channel: -10 to -75 dBm from 0.11 to 12.4 GHz; -10 to -68 dBm from 12.4 to 18 GHz.
Maximum RF input to either channel: 50 mW.
IF gain control: 69 dB range in 10 dB and 1 dB steps with a maximum cumulative error of ± 0.2 dB.

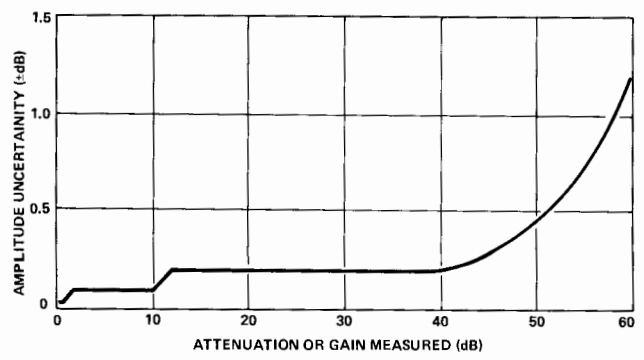

NETWORK ANALYZERS

Test Sets and Accessories

8410 Series

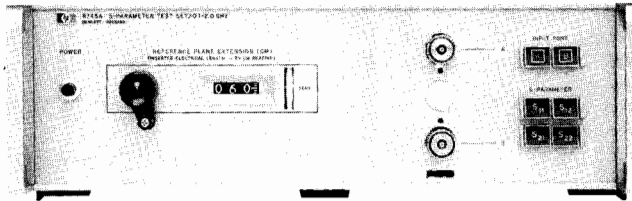

8745A

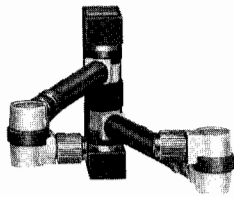

11604A



11602B



11600B

8745A S-Parameter Test Set

Function: wideband RF power splitter and reflectometer with calibrated line stretcher. Pushbutton operated for either forward or reverse transmission or reflection measurements with network analyzer.

Frequency range: 100 MHz to 2 GHz.

Impedance: 50 ohms nominal.

Source reflection coefficient: ≤ 0.057 , 0.11 to 2.0 GHz.

Termination reflection coefficient: < 0.10 , 100, to 200 MHz; < 0.063 , 200 MHz to 2.0 GHz.

Directivity: ≥ 36 dB, below 1 GHz; ≥ 32 dB, 1 to 2 GHz.

Reference plane extension: 0 to 15 cm for reflection; 0 to 30 cm for transmission.

Maximum RF power: 2 watts.

Connectors: RF input type N female; all other connectors APC-7; Option 001, type N female.

Remote programming: ground closure.

Power: 115 or 120 V $\pm 10\%$, 50 to 400 Hz, 40 watts.

Weight: net, 15.4 kg (34.25 lb). Shipping, 18.0 kg (40 lb).

Size: 140 H x 425 W x 654 mm D (5.50" x 16.75" x 25.75").

11604A Universal Extension

Function: mounts on front of 8745A; connects to device under test. Rotary air-lines and rotary joints connect to any two port geometry.

Frequency range: dc to 2 GHz.

Impedance: 50 ohms nominal.

Reflection coefficient: 0.035.

Acc. included: semi-rigid coax. cable, HP Part #11604-20021.

Weight: net, 1.8 kg (4 lb). Shipping, 2.2 kg (5 lb).

Size: 127 H x 32 W x 267 mm D (5" x 1.25" x 10.50").

11600B/11602B Transistor Fixtures

Function: mounts on front of 8745A S-parameter test set; holds devices for S-parameter measurements in a 50 ohm, coax circuit. Both fixtures provide bias for bipolar transistors and FETs. Other devices also fit the fixture (tunnel diodes, etc.).

Transistor Base Patterns

Model 11600B: accepts TO-18/TO-72 packages.

Model 11602B: accepts TO-5/TO-12 packages.

Calibration references: short circuit termination and a 50 ohm through-section.

Frequency ranges: dc to 2 GHz.

Impedance: 50 ohm nominal.

Reflection coefficient: < 0.05 , 100 MHz to 1.0 GHz; < 0.09 , 1.0 to 2 GHz.

Connectors: hybrid APC-7; Option 001, type N female.

Weight: net 1.1 kg (2.38 lb). Shipping, 1.8 kg (4 lb).

Size: 152 H x 44 W x 229 mm D (6" x 1.75" x 9").

8410S Opt 110 Specifications

Function: the 8410S option 110 measurement system configuration is described on page 465. Following are specifications describing measurement capabilities of the 8410C/8411A when used with the 8745A/11604A over the frequency range of 110 MHz to 2 GHz.

Frequency range: 0.11 to 2.0 GHz.

RF input: 20 dB range between +5 dBm and -12 dBm.

Source reflection coefficient: ≤ 0.067 , 0.11-2.0 GHz.

Termination reflection coefficient: ≤ 0.11 , 100-200 MHz; ≤ 0.07 , 200-2000 MHz.

Directivity: ≥ 28 dB 0.11-1.0 GHz; ≥ 27 dB 1.0-2.0 GHz.

Insertion loss, RF input to test port: 4 dB nominal.

Frequency Response

Transmission: typically $< \pm 0.35$ dB amplitude and $< \pm 5^\circ$ phase.

Reflection: typically $< \pm 0.06$ magnitude and $\pm 5^\circ$ phase with a short on the test port.

Transmission measurement accuracy: (see common performance specifications).

Reflection measurement accuracy (using 8414B): sources of error included in the accuracy equations are directivity, source match, and polar display accuracy.

Magnitude Accuracy

$\rho_u = \pm (0.0398 + 0.03 \rho_L + 0.067 \rho_L^2)$ 0.11-1.0 GHz.

$\rho_u = \pm (0.0447 + 0.03 \rho_L + 0.067 \rho_L^2)$ 1.0-2.0 GHz.

$\rho_u =$ magnitude uncertainty.

$\rho_L =$ measured reflection coefficient magnitude.

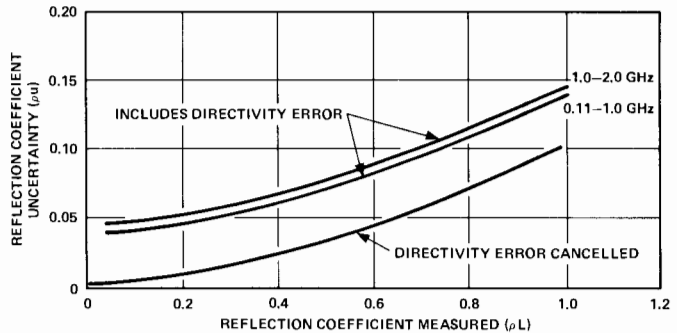

Phase Accuracy

$\Phi_u = \sin^{-1} \rho_u / \rho_L$ for $\Phi_u < 90^\circ$.

$\Phi_u =$ phase uncertainty.

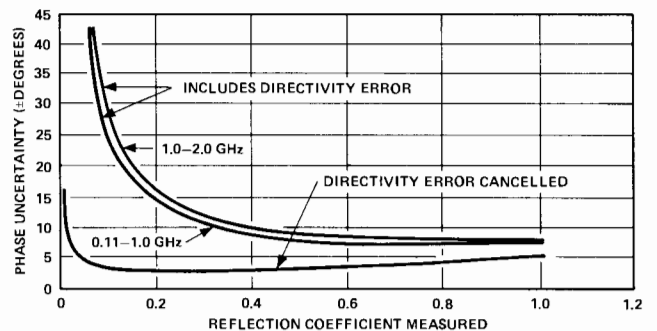

See 8410S Network Analyzer Systems Table for price and instrument breakdown.

Ordering Information

8745A Test Set

Opt 001: Type N Test Port Connectors

Opt 908: Rack Flange Kit

11604A Universal Arm Extension

11600B/11602B Transistor Fixtures

Opt 001: Type N Female Connectors

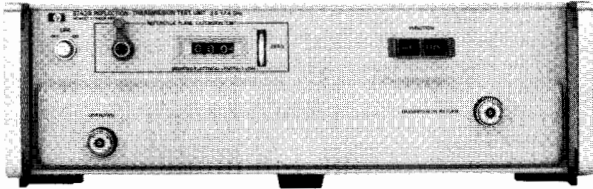

8743B

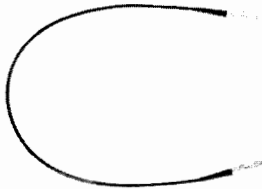

11610B

8743B Reflection/Transmission Test Unit

Function: wideband RF power splitter and reflectometer with calibrated line stretcher. Pushbutton operated for either transmission or reflection measurement with network analyzer. Designed for use with the 11610B Test Port Extension Cable.

Frequency range: 2 to 12.4 GHz, (Opt 018: 2 to 18 GHz).

Impedance: 50 ohms nominal.

Source reflection coefficient: ≤ 0.09 , 2.0 to 8.0 GHz; ≤ 0.13 , 8.0 to 12.4 GHz; < 0.2 , 12.4 to 18 GHz.

Termination reflection coefficient: ≤ 0.13 in reflection mode, 2.0 to 12.4 GHz; ≤ 0.2 in transmission mode, 2.0 to 12.4 GHz; typically < 0.2 , 12.4 to 18 GHz.

Directivity: ≥ 30 dB, 2.0 to 12.4 GHz; ≥ 18 dB, 12.4 to 18 GHz.

Reference plane extension: 0 to 15 cm for reflection; 0 to 30 cm for transmission.

Connectors: RF input, type N female; all other connectors APC-7.

Remote programming: ground closure.

Power: 115 or 230 V $\pm 10\%$, 50-400 Hz, 15 W.

Weight: net, 12.1 kg (29 lb). Shipping, 15.3 kg (34 lb).

Size: 140 H x 425 W x 467 mm D (5.50" x 16.75" x 18.38").

11610B Microwave Cable

Function: a high quality semirigid coaxial cable used with the 8409B Automatic Network Analyzer at frequencies up to 18 GHz. It is designed for applications which require excellent magnitude and phase repeatability from connection to connection. The cable exhibits minimum change in transmission characteristics when flexed during normal use. The 11610B is the recommended transmission return cable for use with the 8743B and the 8746B.

Frequency range: dc to 18 GHz.

Impedance: 50 ohms nominal. Reflection coefficient of ports < 0.14 .

Insertion loss: < 0.7 dB + 0.12 dB/GHz.

Stability with three repeated flexings: < 0.3 dB, < 0.5 degrees + 0.12 degrees/GHz change.

Connectors: APC-7.

Length: 1.07 m (42 inches)

8410S Opt 210 Specifications

Function: the 8410S Option 210 measurement system configuration is described on page 465. Following are specifications describing measurement capabilities of the 8410C/8411A when used with the 8743B/11610B over the frequency range of 2 GHz to 12.4 GHz.

Frequency range: 2.0 to 12.4 GHz.

RF input: 20 dB range between +12 dBm and -5 dBm.

Source reflection coefficient: ≤ 0.09 , 2-8 GHz; ≤ 0.13 , 8-12.4 GHz.

Termination reflection coefficient: ≤ 0.09 , 2-8 GHz; ≤ 0.13 , 8-12.4 GHz.

Directivity: ≥ 30 dB, 2-12.4 GHz.

Insertion loss, RF input to test port: 20 dB nominal.

Frequency Response

Transmission: typically $< \pm 0.5$ dB amplitude and $< \pm 5^\circ$ phase. **Reflection:** typically $< \pm 0.09$ magnitude and $< \pm 6^\circ$ phase, with a short on the unknown port.

Transmission measurement Accuracy (see Common Performance Specifications).

Reflection measurement accuracy (using 8414B): sources of error included in the accuracy equations are directivity, source match, and polar display accuracy.

Magnitude Accuracy

$\rho_u = \pm (0.0316 + 0.03 \rho_L + 0.09 \rho_L^2)$ 2-8 GHz.

$\rho_u = \pm (0.0316 + 0.03 \rho_L + 0.13 \rho_L^2)$ 8-12.4 GHz.

ρ_u = magnitude uncertainty.

ρ_u = measured reflection coefficient magnitude.

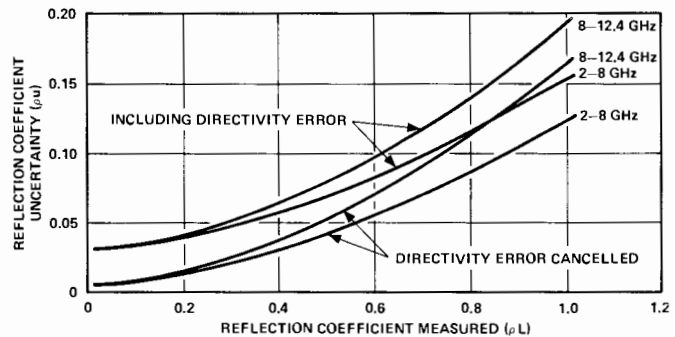

Phase Accuracy

$\Phi_u = \sin^{-1} \rho_u / \rho_L$ for $\Phi_u \leq \pm 90^\circ$.

Φ_u = phase uncertainty.

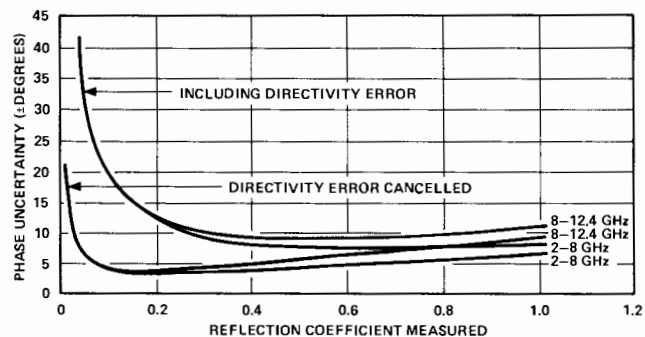

See 8410S Network Analyzer Systems Table for price and instrument breakdown.

Ordering Information

8743B Reflection/Transmission Test Unit

Opt 018: 2 to 18 GHz

Opt 908: Rack Flange Kit

11610B Microwave Cable

NETWORK ANALYZERS

Test Sets and Accessories (cont.)

8410 Series

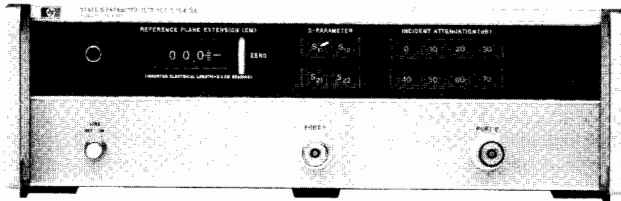

8746B



11608A

8746B S-Parameter Test Set

Function: wideband RF power divider and reflectometer with calibrated line stretcher and a selectable 0-70 dB incident signal attenuator. Provides internal bias for completely characterizing two port active devices.

Frequency range: 0.5 to 12.4 GHz.

Source and termination reflection coefficient: ≤ 0.13 .

Directivity: ≥ 30 dB, 0.5 to 4.0 GHz; ≥ 26 dB, 4.0 to 12.4 GHz.

Incident attenuation: 0-70 dB in 10 dB steps $\pm 5\%$.

Reference plane extension: adds 0 to 15 cm for reflection; 0 to 30 cm for transmission.

Remote programming: ground closure.

Transistor biasing: via 36 Pin connector.

Connectors: input type N female, test ports APC-7.

Opt 001: provides 10 dB higher power level at the test port.

Power: 115 or 230 V $\pm 10\%$, 48 to 440 Hz, 110 VA max.

Weight: net, 16.1 kg (35 lb). Shipping, 19.1 kg (42 lb).

Size: 140 H x 425 W x 467 mm D (5.5" x 16.75" x 18.38").

11608A Transistor Fixture

Function: provides the capability of completely characterizing stripline transistors. A through-line microstrip and bolt-in grounding structure machineable by customer is included.

Frequency range: dc to 12.4 GHz.

Reflection coefficient: < 0.05 , dc to 4 GHz; < 0.07 , 4.0 to 8.0 GHz; > 0.15 , 8 to 12.4 GHz.

Package Styles

Opt 003: 0.205 inch diameter packages.

Calibration references: option 003 only, short circuit termination and a 50-ohm through-section.

Connectors: APC-7 Hybrid.

Weight: net, 0.9 kg (2 lb). Shipping, 1.4 kg (3 lb).

Size: 25 H x 143 W x 89 mm D (1" x 5.63" x 3.5").

8410S Opt 500 Specifications

Function: the 8410S option 500 measurement system configuration is described on page 465. Following are specifications describing measurement capabilities of the 8410C/8411A when used with the 8746B/11608A over the frequency range of 500 MHz to 12.4 GHz.

Frequency range: 0.5 to 12.4 GHz.

Transistor dc bias selection; front panel slide switches establish proper dc biasing for both Bi-polar and FET transistors. The voltage and current controls operation independently and are continuously adjustable over a current range of 0 to 500 mA and a range of 0 to 30 Vdc.

RF input: 20 dB range between +12 and -5 dBm.

Incident attenuation range: 0 to 70 dB in 10 dB steps.

Source reflection coefficient: (typically) ≤ 0.132 , 0.5 to 4.0 GHz; ≤ 0.135 , 4.0 to 8.0 GHz; ± 0.141 , 8.0 to 12.4 GHz.

Termination reflection coefficient: (typically) < 0.139 , 0.5 to 4.0 GHz; < 0.148 , 4.0 to 8.0 GHz; GHz; ± 0.170 , 8.0 to 12.4 GHz.

Directivity: ≥ 28 dB, 0.5 to 4.0 GHz; ≥ 24 dB, 4 to 8.0 GHz; ≥ 23 dB, 8.0 to 12.4 GHz.

Frequency response: (typically) < 0.5 dB, ± 7 degrees, 0.05 to 4.0 GHz; < 0.75 dB, ± 7 degrees, 4.0 to 8.0 GHz; < 1.25 dB, ± 7 degrees, 8.0 to 12.4 GHz.

Transmission measurement accuracy: (see Common Performance Specifications).

Reflection measurement accuracy: sources of error included in the accuracy equation are directivity and source match.

Magnitude Accuracy

$\rho_u = \pm(0.04 + 0.08 \rho_L + 0.13 \rho_L^2)$ 0.5 to 4.0 GHz.

$\rho_u = \pm(0.06 + 0.09 \rho_L + 0.135 \rho_L^2)$ 4.0 to 8.0 GHz.

$\rho_u = \pm(0.074 + 0.098 \rho_L + 0.14 \rho_L^2)$ 8.0 to 12.4 GHz.

ρ_u = magnitude uncertainty.

ρ_L = measured reflection coefficient magnitude.

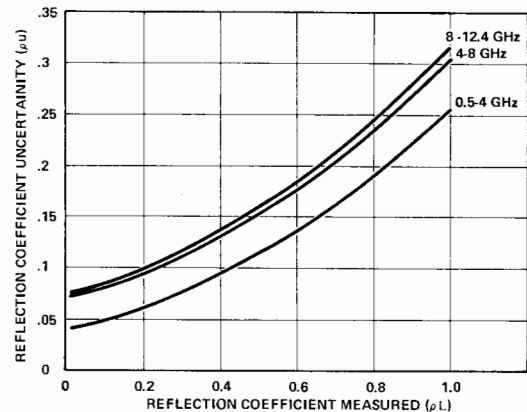

Phase Accuracy

$\Phi_u = \sin^{-1} \rho_u / \rho_L$ for $\Phi_u < 90^\circ$.

Φ_u = phase uncertainty.

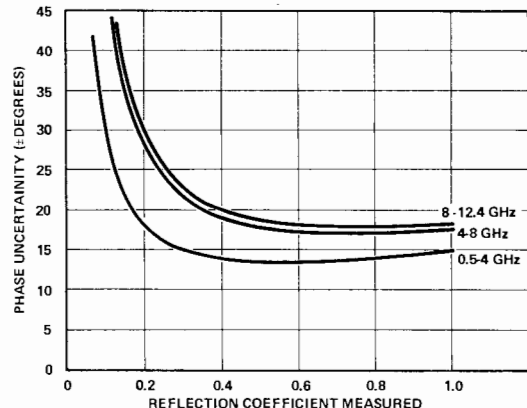

See 8410S Network Analyzer Systems Table for price and instrument breakdown.

Ordering Information

8746B Test Unit

Opt 001: Large Signal

Opt 908: Rack Flange Kit

11608A Transistor Fixture Customer Machineable

Opt 003: 0.205 inch diameter package style

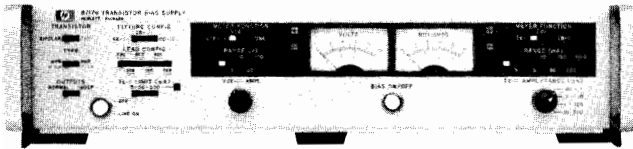

8717B

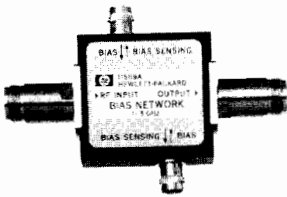

11589A and 11590A

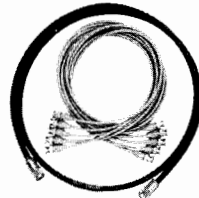

11609A



11650A



11866A

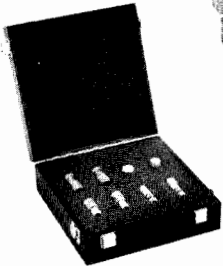

85032A



85033A

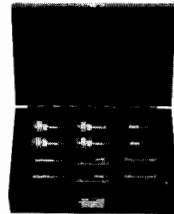

85033B

11589A and 11590A Bias Networks

Function: auxiliary units for use with the 11600B, 11602B and 11608A transistor fixtures. These bias networks provide dc bias to the center conductor of a coaxial line while blocking the dc bias from the input RF circuit.

Frequency range: 11589A—0.1 to 3.0 GHz; 11590A—1.0 to 12.4 GHz; 11590A Option 001—1.0 to 18.0 GHz.

Connectors: BNC for dc biasing; type N female for RF (Option 001; APC-7).

Weight: net, 0.3 kg (0.67 lb). Shipping, 0.5 kg (1 lb).

Size: 29 H x 76 W x 114 mm D (1.38" x 3" x 4.5").

11650A Accessory Kit

Function: accessories normally used for transmission and reflection tests with the 8745A and 8743B.

Weight: net, 1.34 kg (3 lb). Shipping, 2.23 kg (5 lb).

11609A Cable Kit

Function: interconnecting cables normally required for network measurements using the 8410C network analyzer.

Weight: net, 0.9 kg (2 lb). Shipping, 1.36 kg (3 lb).

11866A APC-7 Calibration Kit

Function: a 50 Ω (> 52 dB return loss @ 2 GHz) termination, a short circuit and a shielded open circuit are used with the 8409C to quantify directivity, source match, and frequency tracking errors.

Weight: net 0.57 kg (1.25 lb). Shipping 0.91 kg. (2.0 lb).

Size: 50.8 H x 7 W x 12.7 D (2.0" x 5.0" x 5.0").

85032A Type N Calibration Kit

Function: provides two Type N male to APC-7 adapters, two Type N female to APC-7 adapters, as well as one each Type N male and female short circuits and 50 Ω (<1.01 SWR at 2 GHz) terminations. Option 001 adds one each male and female Type N shielded open circuits.

85033A SMA Calibration Kit

Function: provides two SMA male to APC-7 adapters, two SMA female to APC-7 adapters, as well as one each SMA male and female short circuits and 50 Ω (<1.06 SWR at 1 GHz) terminations.

85033B APC-3.5 Calibration Kit

Function: provides two APC-3.5 male to APC-7 adapters, two APC-3.5 female to APC-7 adapters, as well as one each APC-3.5 male and female short circuits shielded open circuits with center pin extenders, and 50 Ω (<1.03 SWR at 2 GHz) terminations. This kit is specially designed for use with 8409-series Automatic Network Analyzer systems.

8717B Transistor Bias Supply

Function: for manual or programmable transistor testing. It is particularly useful with the 11600B, 11602B, and 11608A Transistor Fixtures. The 8717B has two meters for independently monitoring current and voltage on any of the three leads of a transistor under test. Bias connections are conveniently selected for all transistor configurations with a front panel switch. Special circuitry protects sensitive devices from excessive current transients which commonly occur in less sophisticated supplies.

Voltage ranges: 1, 3, 10, 30, 100 V.

Current ranges: 0.1, 0.3, 1, 3, 10, 30, 100, 300, 1000 mA.

Accuracy: 4% of full scale for both current and voltage.

Option 001: programmable D/A converter.

Weight: net, 9.0 kg (20 lb). Shipping, 11.0 kg (25 lb).

Size: 86 H x 425 W x 336 mm D (3.38" x 16.75" x 13.5").

Ordering Information

8717B Transistor Bias Supply

Opt 001: Programmable D/A Converter

Opt 908: Rack Flange Kit

11589A Bias Network

Opt 001: APC-7 Connectors

11590A Bias Network

Opt 001: APC-7 Connectors, 1–18 GHz

11650A Accessory Kit

11609A Cable Kit

11866A APC-7 Calibration Kit

85032A N Calibration Kit

Opt 001: Shielded Open Circuits

85033A SMA Calibration Kit

85033B APC-3.5 Calibration Kit

NETWORK ANALYZERS

Accessories, Waveguide Test Sets, 8410S Systems (cont.)
8410 Series

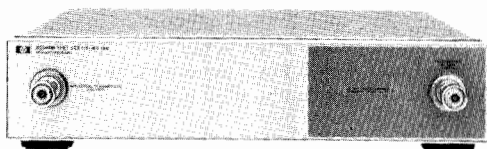

85040B

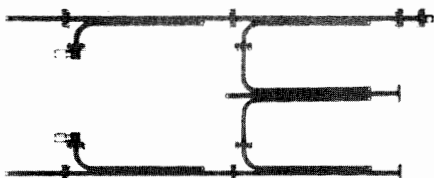

X8747A and P8747A

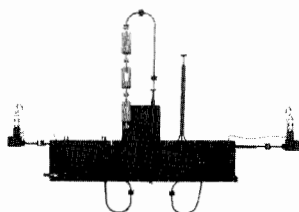

K8747A and R8747B

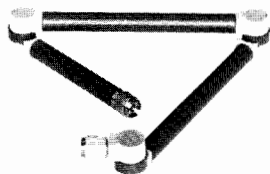

11605A

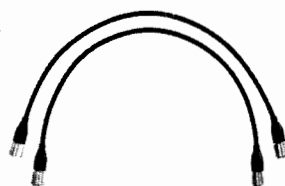

11857A

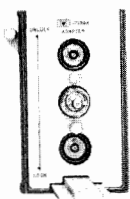

11599A

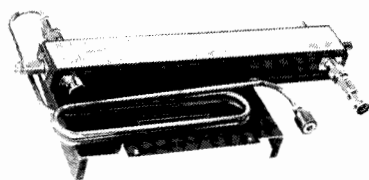

11607A

85040B 0.5–18 GHz Reflection/Transmission Test Set

The HP 85040B is a reflection/transmission test set designed for automatic systems, specifically the HP 8408B Automatic Network Analyzer. Switching between transmission and reflection is done with an external 24 Volt signal from the HP 11713A Attenuator/Switch Driver via a cable supplied with the 85040B.

Frequency range: 0.5 to 18 GHz, (0.1 to 18 GHz transmission only)
Impedance: 50 ohms nominal.

Maximum Operating Level (with 8411A installed)

RF input: +8 dBm.

Test port: +10 dBm.

Transmission return: -10 dBm, +17 dBm damage level.

Connectors: RF input type N female; all other RF connectors APC-7.

Source reflection coefficient: <0.2.

Directivity: >24 dB, 0.5 to 8 GHz; >20 dB, 8 to 18 GHz.

Typical Insertion Loss

RF In to RF Out: <9 dB.

RF Out to 8411A (Reflection Mode): <38 dB, 0.5 to 2 GHz; < 31 dB, 2 to 18 GHz.

Typical Performance with Accuracy Enhancement in 8408B System (in APC-7)

Reflection

Directivity: 40 dB.

Source match: 1.05 SWR.

Frequency response: <0.05 dB, <0.5 degree.

Transmission

Source match: 1.3 SWR

Load match: 1.2 SWR.

Frequency response: <0.05 dB, <0.5 degree.

X8747A, P8747A Reflection/Transmission Test Units

Function: waveguide setup for measuring reflection and transmission parameters of waveguide devices with the network analyzer.

Frequency range: X8747A: 8.2-12.4 GHz; P8747A: 12.4-18 GHz.

K8747A, R8747B Reflection/Transmission Test Units

Function: waveguide setup for measuring reflection and transmission parameters of waveguide devices with the network analyzer; down-converts with built-in mixers to the frequency range of the 8411A.

Frequency range: K8747A: 18-26.5 GHz; R8747B: 26.5-40 GHz.

11605A Flexible Arm

Function: mounts on front of 8743B Test Set; connects to device under test. Rotary air-lines and rotary joints connect to any two-port geometry. Primarily intended for use with existing 8743A's but can be used with 8743B (11610B recommended for use with 8743B).

Frequency range: dc to 12.4 GHz. (Opt 018, 2 to 18 GHz).

Impedance: 50 ohms nominal. Reflection coefficient of ports: ≤0.11, dc to 12.4.

Opt 018: ≤0.23, 2.0 to 12.4 GHz; ≤0.31, 12.4 to 18 GHz.

Connectors: APC-7,

Weight: net, 1.8 kg (4 lb). Shipping, 2.7 kg (6 lb).

Length: 257 mm (10.09") closed; 648 mm (25.50") extended.

11857A 50 Ω APC-7 Test Port Extension Cables

General: two precision 61 cm (24 in.) cables, for use with 8745A S-parameter test set. Connectors are 50 Ω APC-7.

Weight: net, 0.91 kg (2 lb). Shipping, 2.3 kg (5 lb).

11599A Quick Connect Adapter

Function: quickly connects and disconnects the 8745A and the transistor fixtures or 11604A universal extension.

Weight: net, 0.4 kg (0.88 lb). Shipping, 0.9 kg (2 lb).

Size: 127 H x 76 W x 108 mm D (5" x 3" x 4.5").

11607A Small Signal Adapter

Function: used with the 8745A S-parameter test set. The incident signal levels to the test device are reduced to the -20 to -40 dBm range.

Weight: net 4.1 kg (4.63 lb). Shipping, 4.5 kg (10 lb).

Size: 60 H x 413 W x 244 mm D (2.38" x 16.25" x 9.63").

Ordering Information

85040B 0.5–18 GHz Reflection/Transmission Test Set

11605A Flexible Arm

Opt 018: 0.11 to 18 GHz

11857A 50 Ω APC-7 Test Port Extension Cables

11599A Quick Connect Adapter

11607A Small Signal Adapter

X8747A Waveguide Test Set

P8747A Waveguide Test Set

K8747A Waveguide Test Set

R8747B Waveguide Test Set



8413A

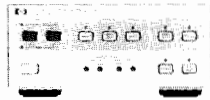

8750A

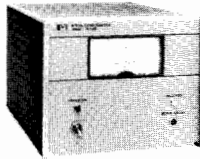

8709B

8413A Phase-Gain Indicator

Function: plug-in meter display unit for 8410C. Displays relative amplitude in dB or relative phase in degrees between reference and test channel inputs. Pushbutton selection of meter function and range.

Amplitude

Range: ± 30 , ± 10 , and ± 3 dB full scale.

Accuracy: $\pm 3\%$ of end scale.

Log output: 50 millivolts per dB up to 60 dB total.

Phase

Range: ± 180 , ± 60 , ± 6 degrees full scale.

Accuracy: $\pm 2\%$ of end scale.

Output: 10 millivolts per degree.

Phase offset: ± 180 degrees in 10-degree steps.

Accuracy: $\pm 2^\circ + 0.3^\circ/10^\circ$ step, cumulative $< 2^\circ$.

Power: 15 watts supplied by mainframe.

Weight: net, 4.9 kg (11 lb). Shipping, 6.7 kg (15 lb).

Size: 152 H x 186 W x 395 mm D (6" x 7.28" x 15.56").

8750A Storage-Normalizer

General: the 8750A Storage-Normalizer provides digitally stored and normalized CRT displays when used with the 8412B Phase Magnitude Display. Measurements are faster, easier and more accurate when the 8750A is employed because the CRT is flicker-free and frequency response errors are eliminated. The 8750A is not compatible with the 8414B Polar Display. Option 003 adds 8412B Compatibility. Detailed specifications on page 468.

8709B Phase Lock Synchronizer

The 8709B Synchronizer is designed for use in the source phase-lock subsystem of HP 8409 type automatic network analyzer systems. Using the 8709B, the HP 8620C or 8350A solid state sweeper is phase-locked to the HP 8410 IF frequency (20.278 MHz). This provides a stabilized, synthesizer class RF source with excellent frequency resolution and accuracy. The 8709B is a dedicated version of the 8709A Synchronizer. The 8709A has a locking frequency of 20 MHz.

Ordering Information

8413A Phase-Gain Display

8750A Storage-Normalizer

Opt 003: 8412B Plug-In Interface Card

8709B Phase Lock Synchronizer

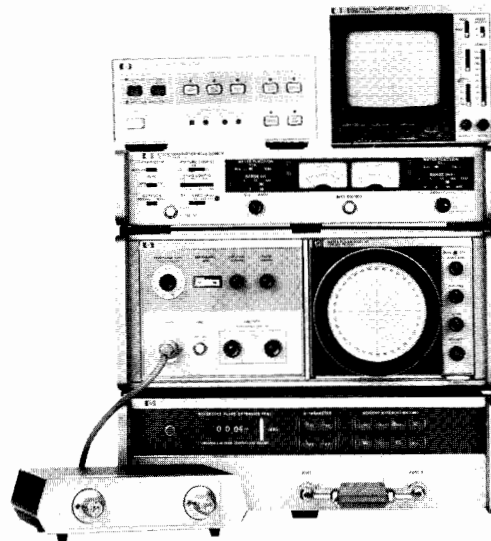

8410S Opt 500

8410S systems enable ordering a complete network analyzer system, except for source, using a single model number. Each option has been configured for making general measurements on coaxial or semiconductor devices. The 8410S Systems enable the operator to view a real time CRT display over octave or multioctave bands with a dynamic range of 60 dB amplitude and 360° phase. Multioctave, continuous network measurements over the frequency range of 2 to 18 GHz are possible when the 8410C is used with the HP 8620C or 8350A Sweep Oscillator.

The 8410S Systems' upper frequency limit for coaxial and semiconductor measurements is 12.4 GHz; however, individual instruments may be ordered that will expand coaxial measurement capability to 18 GHz (option 018 instruments) and waveguide measurements from 8.2 GHz to 40 GHz (8747A series).

8410S Network Analyzer Systems Table

GENERAL PURPOSE MEASUREMENTS			All 8410S Systems Include the Following Instrument Model Numbers: 8410C, 8411A, 8412B, 8414B, 11609A, and 8750A opt. 003									
Frequency Range	Option No.	Measurement Port Configuration	8743B	8745A	8746A	8717B	11600B	11602B	11608A	11604A	11610B	11650A
0.11 to 2 GHz	110	Coaxial (APC-7)		X						X		X
0.11 to 12.4 GHz	310	Coaxial (APC-7)	X	X						X	X	X
2 to 12.4 GHz	210	Coaxial (APC-7)	X								X	X
SEMICONDUCTOR CHARACTERIZATION												
0.11 to 2 GHz	400	T018/T072 Packages		X		X	X					
0.11 to 2 GHz	401	T05/T012 Packages		X		X		X				
0.5 to 12.4 GHz	500	Stripline			X	X			X			



NETWORK ANALYZERS

**Automatic Network Analyzer System, 500 MHz to 18 GHz
Model 8408S**

- 40 dB effective directivity
- Economical reflection and transmission measurements
- 8-term vector error-correction
- Friendly, easy-to-use

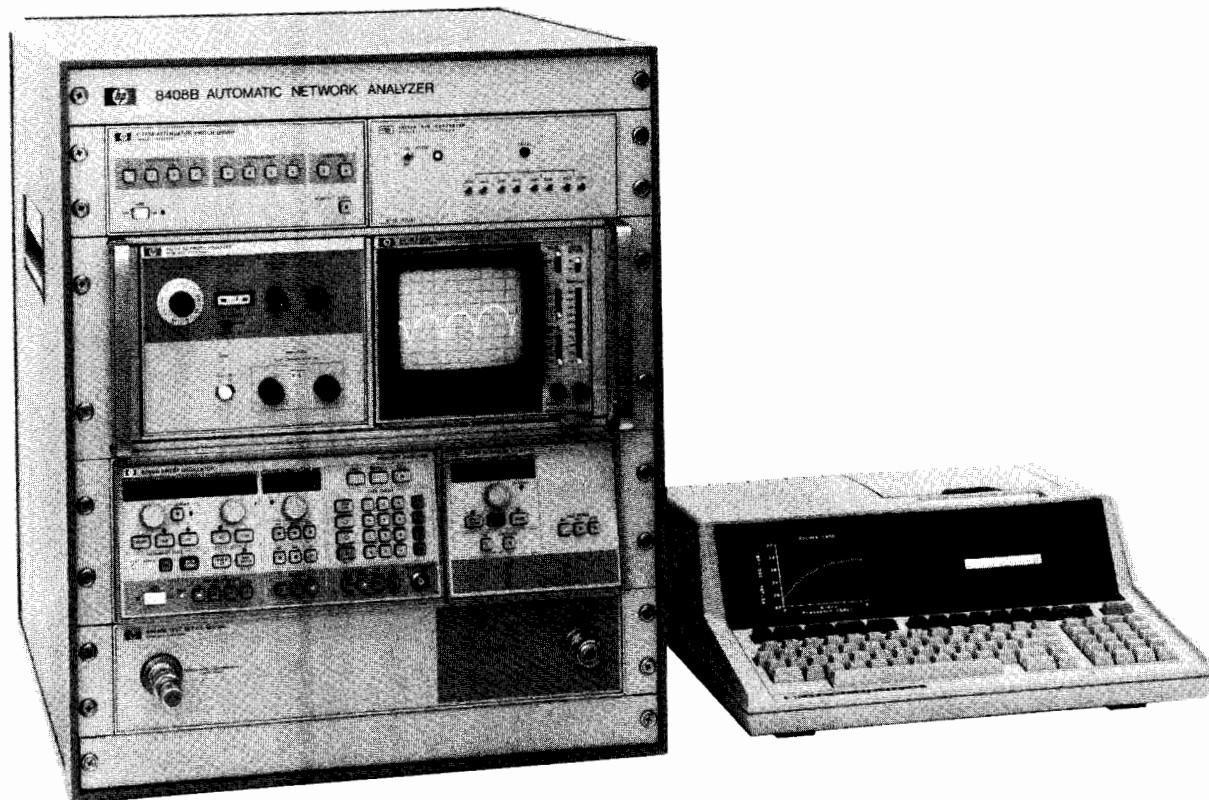

Description

The HP 8408S Automatic Network Analyzer is a complete microwave network measurement system composed of a network analyzer (receiver), reflection/transmission test set, programmable source, computing controller, and accuracy enhancement pac for making vector error-corrected measurements. The HP 8408S system is fully assembled and integrated at the factory. All accessories and cables necessary for making transmission and reflection measurements are supplied with the system, including calibration standards for measurements in APC-7.

Utilizing a single broadband source and test set, this system measures return loss and transmission (magnitude and phase) over the 500 MHz to 18 GHz frequency range. To verify that the proper connections have been made or to adjust the test device, a real-time CRT display of swept magnitude and phase is provided over the selected frequency range. The test set is a one path reflection transmission test set. The 85040B Test Set is a low cost test set designed for automatic systems. When used with the 11873B Accuracy Enhancement Pac in the 8408S system, measurements can be made from 500 MHz to 18 GHz with an effective system directivity better than 40 dB.

The HP 8408S is a tuned receiver that allows both magnitude and phase information of the test signal to be obtained. In comparison to a magnitude-only (scalar) measurement system, a tuned receiver provides a 60 dB measurement range that is immune to measurement ambiguities caused by source harmonics or spurious signals. Using phase information, system errors like directivity and source match can be measured and effectively removed. Hence magnitude measurements can be made with much greater accuracy than in scalar systems.

The HP 8408S makes vector error-corrected measurements by initially measuring several calibration standards in order to quantify and store the repeatable system errors. Then at each measurement

frequency the measured data is enhanced by using an 8-term error correction model that effectively removes these system errors. By using vector error-correction and the appropriate calibration standards, the effective system directivity is better than 40 dB at the measurement test port using the desired test connector type.

The 11873A Accuracy Enhancement Pac provided with the system allows the user to immediately make measurements at up to 100 frequencies. The software guides the user via simple prompts through the initial setup, calibration, measurement, and output sequences in order to simplify system operation. After measuring the test device, the data can be displayed in a tabular listing, plotted versus frequency in a rectangular format, or plotted in a polar format. Direct the output to the CRT or the internal thermal printer for hard copy results. When plotting, you even have the option of selecting the scale values or letting the software automatically scale the data for you.

For measurements in APC-3.5 or Type-N, the proper calibration standards and adapters are available. For APC-3.5, use the 85033B Calibration Kit and 911C Sliding Load. For Type-N, use the 85032A Option 001 Calibration Kit. The sliding load provided with the system can be used for APC-7 and Type-N.

Ordering Information

System Reference

8408S Automatic Network analyzer

Network Analyzer Subsystem

8408B Network Analyzer Subsystem 0.5-18 GHz

Option 001 2-18 GHz only

Option 003 Delete Sweep Oscillator Plug-in

Computer

Model 85F Personal Computer

82903A 16K byte Memory Module

00085-15002 Print/Plot ROM

00085-15004 Matrix ROM

ELECTRONIC COUNTERS

Automatic Network Analyzer System, 110 MHz to 18 GHz

Model 8409S



- Synthesized network analyzer with phase-locked source
- Full S-parameter and group delay measurement capability
- High performance calibration/metrology system
- 12-term vector error-correction

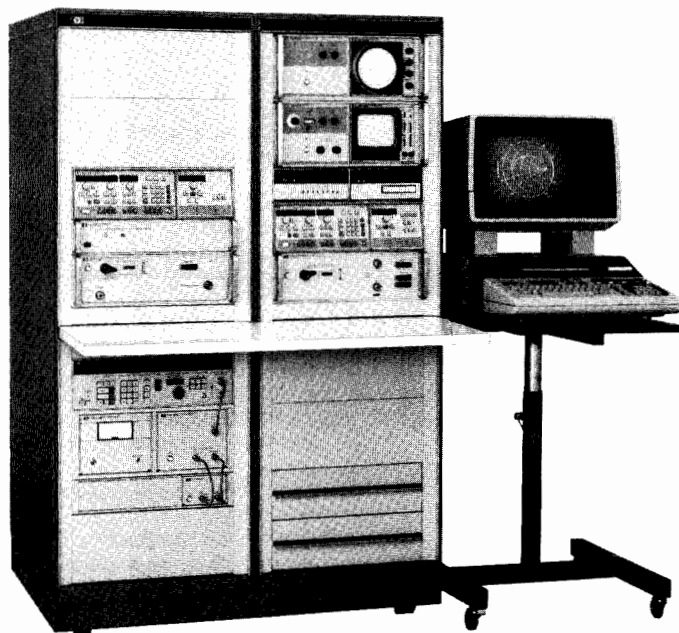

Description

The HP 8409S Automatic Network Analyzer is a complete, high performance microwave network measurement system for high accuracy, vector error-corrected S-Parameter and Group Delay measurements. The system includes a synthesized network analyzer, phase-locked source, S-Parameter test set, desktop computer, and software using a comprehensive vector error-correction model. The 8409S is ideal for calibration requirements and difficult to measure devices that have either very low or high input reflection coefficients, such as cables and transistors. All accessories are provided for vector error-corrected measurements in APC-7, APC-3.5, and Type N.

The Phase-lock subsystem provides a synthesized receiver for improved measurement accuracy and a synthesizer class phase-locked source for high resolution frequency control. For best measurement accuracy and dynamic range, phase and low level magnitude information is taken from a polar display, with a phase-magnitude display used for all other information. The vector error-correction model used in the system is user selectable between the simple 8-term model and a more comprehensive 12-term model. This allows flexibility in making tradeoffs between measurement accuracy and speed depending on unique measurement requirements.

System Configurations

The standard 8409S system is a two bay rack that covers the 110 MHz to 18 GHz frequency range in two bands: 110 MHz to 2 GHz, and 2 to 18 GHz, with the appropriate source and test set outputs automatically switched to the network analyzer. The system is controlled by a 9845B Desktop Computer that uses the 11863F Accuracy Enhancement Pac, a BASIC language program. Also available is the 9826A Desktop Computer and its associated 11863E Accuracy Enhancement Pac (an HPL program that provides the same measurement capability as the 11863F software).

For narrower frequency coverage, select either 2 to 18 GHz, or 500 MHz to 12.4 GHz, coverage. These single bay rack versions utilize a single source and test set combination. For active device measurements over the 500 MHz to 12.4 GHz frequency range, two configurations include a programmable bias supply (8717B) with the proper control hardware for use with either the 9845B or the 9826A Desktop Computer. For less demanding applications, the phase-lock subsystem can be deleted in any 8409C configuration.

Ordering Information

System Reference

8409S Automatic Network Analyzer

Network Analyzer Subsystem

8409C Network Analyzer Subsystem 110 MHz to 18 GHz

2 GHz to 18 GHz Frequency Range

Option 001 2 GHz to 18 GHz Frequency Range

500 MHz to 12.4 GHz Frequency Range

Option 010 No Bias Supply

Option 011 With Bias Supply and 9845B Interface

Option 012 With Bias Supply and Series 200 Interface

Delete Source Phase-Lock Subsystem

Option 100 8409C w/o Source Phase Lock

Option 101 8409C Opt. 001 w/o Source Phase Lock

Option 110 8409C Opt. 010 w/o Source Phase Lock

Option 111 8409C Opt. 011 w/o Source Phase Lock

Option 112 8409C Opt. 012 w/o Source Phase Lock

230 VAC Line Operation

Option 230 For Two Bay

Option 231 For Single Bay

Computer and Software

Series 200 Model 26A

9826A Model 26A Computer

98604A ROM-based HPL 2.0 Language System

Option 655 Internal 5¼ in.

98256A 256K byte memory board

2673A Thermal Printer

11863E Accuracy Enhancement Software, 5¼ in.

Series 200 Model 36A

9836A Model 36A Computer

98604A ROM-based HPL 2.0 Language System

98256A 256K byte memory board

2673A Thermal Printer

11863E Accuracy Enhancement Software, 5¼ in.

Model 9845

9845B Desktop Controller

Option 280 Data Base Management

Option 330 English Language Keyboard

11863F Accuracy Enhancement Software, Series

9845 Option 280 BASIC



NETWORK ANALYZERS

Storage-Normalizer

Model 8750A

- Digital storage and normalization
- Simple CRT photos and x-y recordings
- Use with HP network and spectrum analyzers

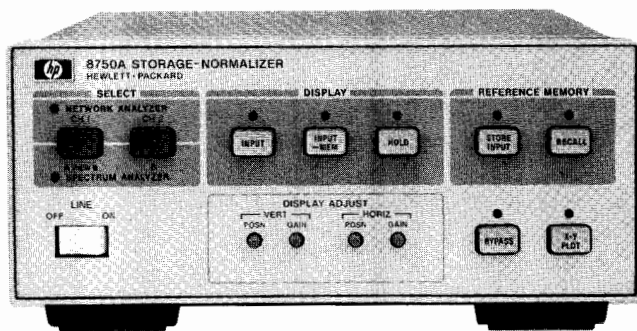

8750A

With HP's versatile 8750A Storage-Normalizer, you can make your network analyzer or spectrum analyzer measurements faster, easier, and more accurately through the simple addition of digital storage and normalization. This useful instrument accessory is directly compatible via a single interface cable with the following recently produced or appropriately modified Hewlett-Packard instruments; the 8755 Frequency Response Test Set, the 8407A/8412A, the 8410/8412A, the 8754A and the 8505A Networks Analyzers and 8557A, 8558B, 8565A and 8559A Spectrum Analyzers. A special I/O Adapter (opt 001 or opt 002) is available for interfacing instruments (like 140 Series Spectrum Analyzers) that are not directly compatible with the 8750A. An external oscilloscope can then be used for digitally stored and normalized displays. (The 8750A is not compatible with the 8414A Polar Display or the polar mode of the 8505A or the 8754A.)

In network analyzer applications, digital storage always yields a flicker-free display of the complete device response, facilitating easy adjustment of test devices under slow sweep conditions. Measurement accuracy is also improved since frequency response errors can be automatically removed through digital normalization. This effectively eliminates the need to manually record calibration traces on a CRT or x-y recorder and allows high resolution measurements of attenuator, amplifier, or filter passband flatness.

In spectrum analyzer applications, the 8750A's digital storage feature simplifies many difficult tests requiring slow scan times such as high resolution modulation measurements. Drift tests are also easy since two traces, a stored reference and the current input, can be displayed simultaneously.

Hard copy documentation can be obtained quickly and easily since data can be frozen on the CRT for straightforward CRT photography or outputted to an x-y recorder at a constant 30 second sweep rate.

Supplemental Performance Characteristics

Display

Horizontal memory resolution: two display channels, 256 points per channel (0.4% of full scale, 8 bit word)

Vertical memory resolution: 512 points displayed full scale (0.2% of full scale, 10 bit word) plus a 50% overrange (256 points) both above and below full screen.

Horizontal input sweep rates: 100 s. max./10 ms. min.

Display refresh rate: 6 ms.

Video Detection

Network analyzer: average detection (20 kHz).

Spectrum analyzer: peak detection.

Input/Output

A/D Horizontal Input

Network analyzer: 0 to 10 V nominal. Offset ± 0.5 V and Gain Adjust for 6 to 15 V sweep.

Spectrum analyzers: ± 5 V nominal. Offset ± 0.5 V and Gain Adjust for ± 4.5 to ± 5.5 V.

A/D Vertical Input

Network analyzer: ± 1 V min. and ± 2 V max, with continuous gain adjustment. Offset ± 0.3 V.

Spectrum analyzer: 0 to 0.8 V or 0 to -0.8 V. Offset ± 0.1 V and Gain Adjust $\pm 10\%$.

D/A Horizontal Output

Network analyzer: gain adjustment for 1 to 3 V peak. Offset adjustment $+5$ to -1.5 V.

Spectrum analyzer: gain adjustment for 1 to 3 V peak. Offset $+5$ to -1.5 V.

D/A Vertical Output

Network analyzer: same as Vertical Input with $\pm 10\%$ adjustment range.

Spectrum analyzer: same as Vertical Input with $\pm 10\%$ adjustment range.

X-Y Recorder Outputs

Horizontal range and accuracy: 0 ± 20 mV to 1 V nominal, settable within $\pm 3\%$ of full scale. BNC female output (rear panel).

Vertical range and accuracy: ± 4 V $\pm 3\%$ BNC female output (rear panel).

Sweep time: 30 sec per displayed trace.

Penlift output: BNC female (rear panel with open collector driver 20 V maximum.)

Controls

Select: LED display indicates Network or Spectrum Analyzer operation depending on the plug-in interface card.

Display

Input: initiates digital storage.

Input-mem (input minus memory): stored Reference trace is subtracted from input data (normalization).

Hold: freezes display for CRT photos or further analysis.

Reference Memory

Store input: current input trace is stored as Reference.

Recall: displays stored Reference trace.

Bypass: bypasses 8750A so display is returned to conventional analog operation.

X-Y Plot: initiates X-Y plots.

General

Interface cards: the 8750A is supplied with two general plug-in interface cards. One for use with the HP Spectrum Analyzers listed above, one for use with the 8407A/8412A and 8505A Network Analyzers. When the 8750A is to be used primarily with an 8755B/C Frequency Response Test Set and 8350A/8620C Sweeper, 8410B/8412A Network Analyzer and 8350A/8620C Sweeper, or the 8754A Network Analyzer, calibration and adjustment of the 8750A to these instruments can be greatly simplified by ordering one of the plug-in interface cards dedicated to these instruments (Opt. 003 and 004.) All offset and gain adjustments are significantly reduced. When Opt. 003 or 004 are ordered the two general interface cards are also included so you have the flexibility to change your test set up at any time.

Power: selection 100, 120, 220, or 240 V $+5\%$ -10% . 48 to 440 Hz and <20 VA (<20 watts).

Size: 102 H x 212 W x 280 mm D (4" x 8.4" x 11.2").

Weight: net. 2.72 kg (6.1 lbs). Shipping, 5.0 kg (11 lbs).

Ordering Information

8750A Storage-Normalizer

Opt 001: BNC Interface Adapter (Deletes direct interface cable)

Opt 002: BNC Interface Adapter (Retains direct interface cable)

Opt 003: 8755B/C or 8412A/8620C Plug-in Interface Card

Opt 004: 8754A Plug-in Interface Card

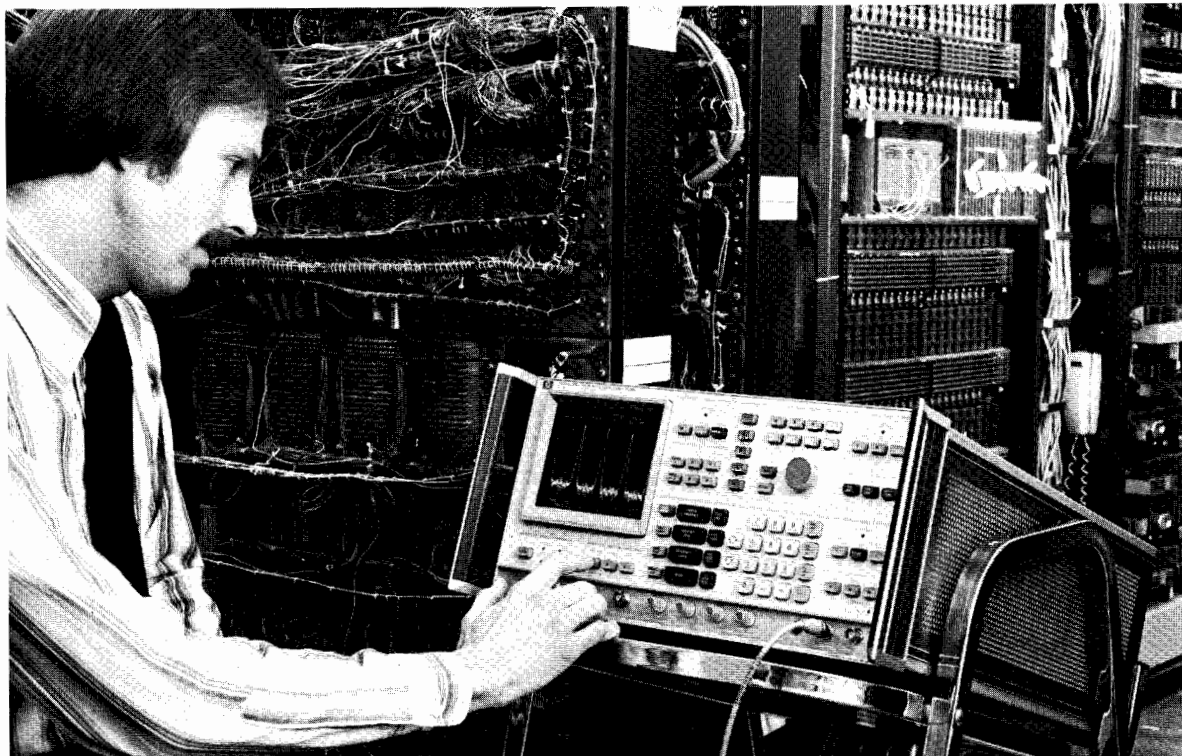

Analysis of signals in the frequency domain is an important measurement concept which is widely used for providing electrical and physical system performance information. Several examples will illustrate some important applications where signal analyzers are useful.

Mechanical Measurements

Noise and vibration levels are of major concern to manufacturers and users of mechanical structures such as aircraft, automobiles, and bridges. With an appropriate motion-to-electrical signal transducer the spectrum analyzer or the Fourier analyzer can examine vibration signals in the frequency domain. This makes it possible to monitor and analyze vibration components of rotating machines associated with unbalance, worn bearings or worn gears, and to identify a structure's natural modes of vibration.

Communications

In the fields of telecommunications, the spectrum, modulation, wave and audio analyzers provide vital operational performance verification of transceivers and multiplex systems. Unwanted signals such as carrier leak signals, out-of-band noise, and cross modulated signals must be identified. System gain, loss, distortion and pilot tone measurements must also be made. These measurements are discussed in more detail in the Telecommunications Test Equipment section of this catalog.

Electronic Testing

Finally, in the general field of electronics, there are four primary uses for the signal analyzer. First, the analyzer is used to identify and measure signals which result from non-linear effects in the process of amplification, filtering, and mixing. Second, the purity of signal sources is commonly observed. Third, the modulation analyzer serves a spe-

cial purpose in analyzing modulated communication signals by measuring and displaying RF power, frequency and modulation characteristics. Fourth, the signal analyzer with a companion tracking generator is used as an amplitude only network analyzer for frequency response measurements of filters, amplifiers, and many other types of networks.

Basic Analyzers

This section discusses the definition and use of several types of instruments for frequency response signal analysis: spectrum analyzers, digital Fourier analyzers, wave analyzers, distortion analyzers, audio analyzers, modulation analyzers and measuring receivers.

Each of these instruments measure basic properties of a signal in the frequency domain, but each uses a different technique. The spectrum analyzer is a swept receiver that provides a visual display of amplitude versus frequency. It shows on a single display how energy is distributed as a function of frequency, displaying the absolute value of Fourier components of a given waveform. The Fourier analyzer uses digital sampling and transformation techniques to form a Fourier spectrum display that has phase as well as amplitude information. The wave analyzer is the true tuned voltmeter, showing on a meter the amplitude of the energy in a specific frequency window which is tunable over a specific frequency range. The distortion analyzer performs an almost reciprocal function to that of the wave analyzer. It collectively measures the energy outside a specific bandwidth tuning out the fundamental signal and displaying the energy of the harmonics and other distortion products on a meter. The audio analyzer performs the same measurement function as a distortion analyzer but also includes the additional measurement functions of SINAD, signal to noise ratio, frequency count, true rms dvm

and dc dvm. The modulation analyzer tunes to the desired signal and recovers the entire modulation envelope of AM, FM and phase modulation for processing and display. The measuring receiver adds to the capabilities of the modulation analyzer the ability to very accurately measure signals down to -127 dBm.

Different Views

Figure 1 shows a graphical representation of the way five of the analyzers view a signal and one harmonic. The time domain scan of the signal is presented in Figure 1a. $A(t)$ is the complex voltage waveform as it would be viewed on an oscilloscope. The dashed lines represent the vector components of the signal: $A_1(t)$, the fundamental and $A_2(t)$ the second harmonic. In 1b, the spectrum analyzer displays the frequency spectrum showing both vector components and their amplitude relationship. Spectrum analysis is useful from 0.02 Hz to 220 GHz.

The Fourier analyzer uses digital signal processing techniques to extract both the amplitude and phase information about each spectral component. Conceptually the Fourier analyzer can be viewed as measuring a large number (up to 2048) of parallel filters as shown in Figure 1c. These filters are actually very specialized digital filters so that precise, repeatable results can be obtained. With this arrangement of parallel filters the complete display is generated in the time that it takes to analyze the lowest frequency component. HP Fourier analyzers presently cover the range of dc to 100 kHz.

The wave analyzer in Figure 1d, measures the amplitude and frequency of the signal in the frequency window to which it is tuned. This window can be moved to measure the amplitude of the second harmonic, thereby making a precise comparison with the fundamental. This technique is practical from 15 Hz to above 32 MHz.

SIGNAL ANALYZERS

Wave, Distortion, Modulation, Spectrum and Fourier Analyzers (cont.)

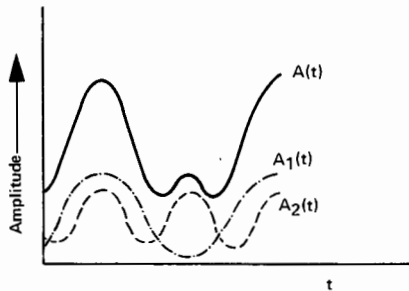

Figure 1a. Waveform

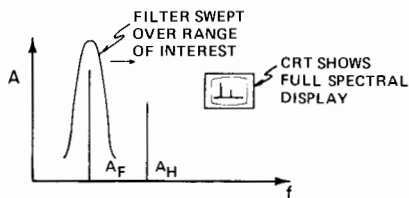

Figure 1b. Spectrum analyzer

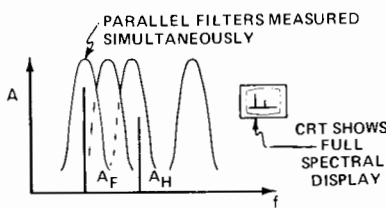

Figure 1c. Fourier analyzer

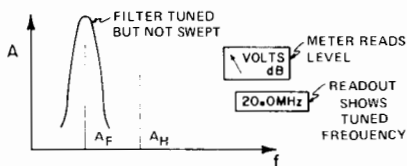

Figure 1d. Wave analyzer

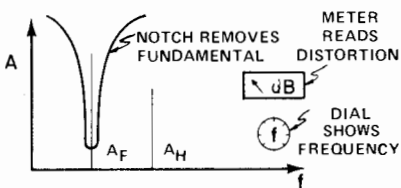

Figure 1e. Distortion analyzer

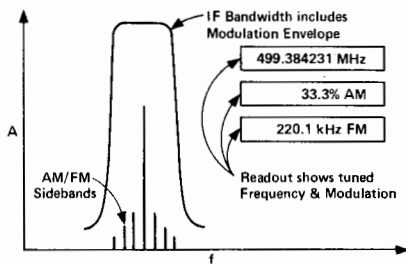

Figure 1f. Modulation analyzer

The distortion analyzer as pictured in Figure 1e. rejects the fundamental to which it has been tuned and measures the energy everywhere else within the instrument's frequency spectrum. Distortion, as a percentage or in dB down from the fundamental, is displayed directly on a meter. Hewlett-Packard distortion analyzers cover 5 Hz to 600 kHz.

The modulation analyzer of Figure 1f and the measuring receiver tune to a desired frequency just as the wave analyzer. Their IF bandwidths and detection systems are designed to pass the entire modulation envelope so that percent modulation, distortion, residual and peak deviation measurements can be made. All close-in spectral components are combined in the measurement.

The following section considers each instrument technique, showing the particular strength and flexibility of each.

Spectrum Analyzers

To display useful information about a frequency scan, a spectrum analyzer must be sensitive, frequency stable, free of spurious responses over a wide band, and have calibrated accuracy in the CRT display. The examples which follow best demonstrate the wide variety of information which can be measured on the spectrum analyzer.

Measurements with the Spectrum Analyzer

CW signal: the most basic spectrum analysis measurement is the single CW signal.

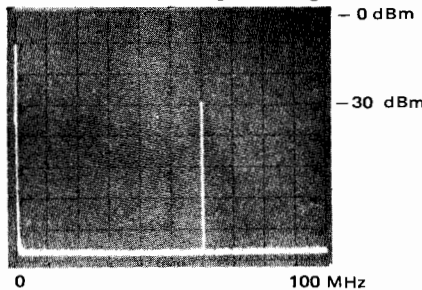

Pictured is a -30 dBm signal at 60 MHz. The zero frequency indicator is at the far left graticule line.

Spectral purity of a CW signal: one very important oscillator signal measurement is spectral purity. This 70 MHz carrier has power line related sidebands (± 60 Hz) which are 65 dB down.

Such sidebands may result from power supply ripple. The 50 Hz/division spectrum analyzer scan and the 10 Hz analyzer bandwidth provide the high degree of resolution required to see these sidebands.

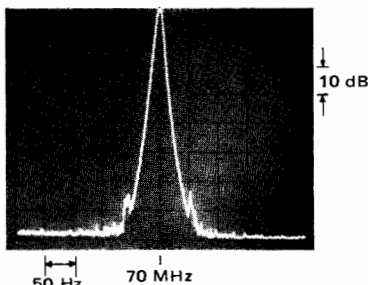

Frequency conversion products: the spectrum analyzer is well suited for frequency conversion measurements such as the output of a balanced mixer as shown.

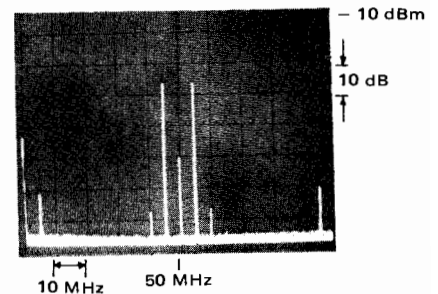

With the 50 MHz local oscillator input at 0 dBm and a 5 MHz, -30 dBm mixer signal, two sidebands at 45 MHz and 55 MHz result. The sidebands are -36 dBm, giving the mixer a 6 dB conversion loss. The local oscillator has 60 dB isolation and the 5 MHz signal has 41 dB isolation. Second order distortion products at 40 and 60 MHz are 40 dB below the desired mixer outputs.

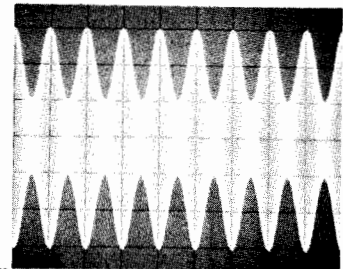

Oscilloscope

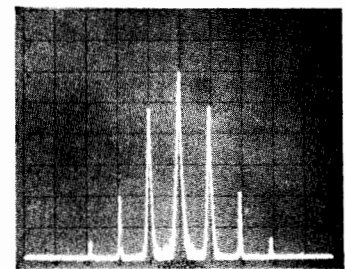

Spectrum Analyzer

Amplitude modulation: percent amplitude modulation is often more easily measured with the spectrum analyzer than it is with the oscilloscope. This is especially true for low level modulation.

With the oscilloscope time display, percent modulation, M , is measured as a ratio of the signal's dimensions: $M = 100(6-2)/(6+2) = 50\%$. In the spectrum analyzer display, whose vertical calibration is 10 dB/division, the carrier and sidebands differ by 12 dB, the voltages in the sidebands are $1/4$ of that of the carrier and again, $M = 50\%$. At the same time the second and third harmonic distortion of the sidebands can be measured at 28 and 44 dB respectively.

Frequency modulation: information transmitted by FM can be characterized by the spectrum analyzer.

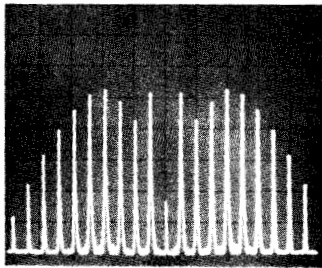

20 kHz Low Deviation FM

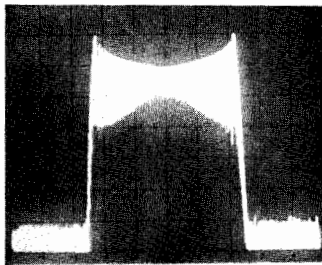

0.5 MHz High Deviation FM

Low deviation FM is applied to a 60 MHz carrier in the first photo. The deviation has been adjusted for the second carrier null ($M = 5.52$). The sideband spacing is 10 kHz, the modulation frequency; therefore, Δf peak = $5.52 \times 10 \text{ kHz} = 55.2 \text{ kHz}$.

The second photo is an example of a high deviation FM. The transmission bandwidth is 2.5 MHz.

Pulsed CW power: by viewing the spectra of a repetitive RF pulse on the spectrum analyzer, pulse width, average and peak power, occupied bandwidth, and duty cycle can be determined.

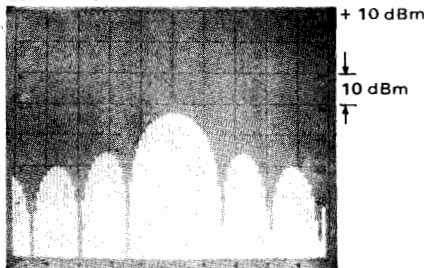

0.5 MHz 6.3 GHz

From the spectral output shown the pulse's complete characteristics are determined: 6.3 GHz RF at 0 dBm, pulsed at 50 kHz rate. The pulse width is 1.3 μs .

EMI: Spectrum analyzers have long been a useful tool in the evaluation of electromagnetic interference (EMI). They are valuable for preliminary design troubleshooting and qualification testing. The spectrum analyzer's ability to display wide frequency spans provides "quick look" capability for locating EMI "hot spots". The high performance spectrum analyzers (8566A and 8568A) of-

fer full programmability, allowing automatic EMI measurements. With the addition of the Quasi-Peak Adapter (HP 85650A), these analyzers can make quasi-peak measurements used in commercial EMI tests.

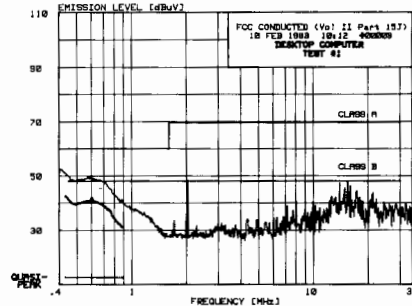

Plot of FCC conducted emissions test using peak and quasi-peak detection

Noise: spectrum analysis is effective in measuring impulse noise, random noise, carrier to noise ratio, and amplifier noise figure.

Phase noise: the short term frequency fluctuations of a sine wave source can be measured directly as phase modulation sidebands. Hewlett-Packard spectrum analyzers with narrow resolution and synthesized internal frequency sources can make many phase noise measurements directly. Bandwidth corrections, analyzer corrections, data averaging and setup calibration factors can be accounted for by Hewlett-Packard microprocessor controlled spectrum analyzers. All instrument controls, data transfer and data reduction can be handled by easy-to-write software for Automatic Spectrum Analyzers.

Frequency response: using a tracking signal source and a spectrum analyzer the frequency response of filters can be displayed with ease.

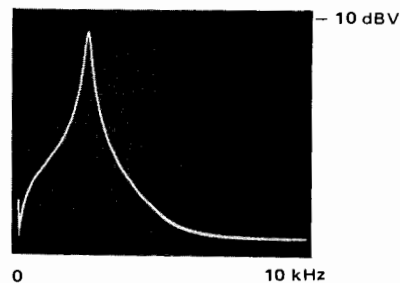

In this case, an audio filter used in a communications system is being measured. Since the input reference level to the filter is -13 dBV, the insertion loss at 2.4 kHz is 4 dB. Extremely high Q devices can be measured with this system.

Spectrum Analyzer Capabilities

To be useful in making measurements in the frequency domain, the analyzer must be capable of making quantitative measurements. Specifically, an analyzer must:

1. make absolute *frequency* measurements
2. make absolute *amplitude* measurements
3. operate over a *large amplitude dynamic range*

4. have *high resolution* of frequency and amplitude

5. have *high sensitivity*

6. provide means of *observing, preserving, and recording* its output in a convenient and rapid manner by using variable persistence, digital storage and adaptive sweep. Hewlett-Packard spectrum analyzers excel in these six measures of performance. Let us consider each of these performance standards in greater detail.

Absolute frequency measurements: frequency readout accuracy depends upon the tuning and readout techniques employed, as well as the stability of the spectrum analyzer's frequency reference. The absolute frequency accuracy read off the slide-rule type of frequency dial is approximately 1% of full scale. Synthesized local oscillators allow accuracies to $\pm 4 \text{ Hz}$ at 1500 MHz in narrow frequency spans. When the spectrum analyzer is used in conjunction with a tracking generator (a source whose frequency is the same as the analyzer tuning frequency) accuracy much better than 1% can be achieved by counting the generator output.

Extended frequency capabilities: the frequency range of microwave spectrum analyzers can be extended to the millimeter frequency bands where waveguide transmission lines are required. This frequency extension is accomplished by using external harmonic mixers to convert the millimeter signal frequency down into the range of the spectrum analyzer. Hewlett-Packard Harmonic Mixers provide a high level of performance for measurements in these millimeter frequency bands from 18 to 60 GHz. Their characteristics include excellent absolute amplitude accuracy and low conversion loss, the latter providing high sensitivity. In addition, no mixer bias is required, allowing full waveguide band measurements to be made easily and accurately. The non-biased feature also makes these mixers highly suitable for fully automatic systems, since there is no need to adjust a bias current over the frequency range to achieve the best flatness. For more information on millimeter measurements, refer to page 513.

Absolute amplitude measurements: all Hewlett-Packard spectrum analyzers are absolutely calibrated for amplitude measurements. This means the spectrum analyzer indicates to the user what the log/reference level or linear sensitivity is regardless of control settings. Either a warning light or CRT message indicates an uncalibrated condition, making operation of the analyzer easy and foolproof.

Microprocessor controlled analyzers feature built-in calibration routines which account for changes in analyzer controls such as the resolution bandwidth and RF attenuator.

Dynamic range: the dynamic range of a spectrum analyzer is defined as the difference between the input signal level and the average noise level or distortion products, whichever is greater. Hence, dynamic range can be either distortion limited, noise limited or display limited. Hewlett-Packard micro-

SIGNAL ANALYZERS

Wave, Distortion, Modulation, Spectrum and Fourier Analyzers (cont.)

processor controlled analyzers can be set to ensure that distortion products of on-screen signals will be below a certain level.

Frequency and amplitude resolution: frequency resolution is the ability of the analyzer to separate signals closely spaced in frequency. The frequency resolution of an analyzer is a function of three factors: 1) minimum IF bandwidth, 2) IF filter shape factor, 3) spectrum analyzer stability.

The minimum IF bandwidth ranges down to 1 Hz on Hewlett-Packard spectrum analyzers.

One way to define IF filter shape factor is the ratio of 60 dB bandwidth to 3 dB bandwidth. Filter shape factor specifies the selectivity of the IF filter. Hewlett-Packard spectrum analyzers have IF filter shape factors as low as 5:1.

Analyzer frequency stability also limits resolution. The residual FM (short term stability) should be less than the narrowest IF bandwidth. If not, the signal would drift in and out of the IF pass band. Hewlett-Packard analyzers have excellent stability. Low frequency and microwave frequency models are available with residual FM <1 Hz, enabling the measurement of noise sidebands. The stabilization circuitry is completely automatic and foolproof. No signal recentering, manual search, or checking is required.

Amplitude resolution is a function of the vertical scale calibration. Hewlett-Packard analyzers offer both log calibration for observing large amplitude variations (10, 5, 2 and 1 dB/div) and linear calibration for observing small amplitude variations.

Sensitivity: sensitivity is a measure of an analyzer's ability to detect small signals, and is often defined as the point where the signal level is equal to the noise level or (S+N)/N=2. Since noise level decreases as the bandwidth is decreased, sensitivity is a function of bandwidth. The maximum attainable sensitivity ranges from -150 dBm to -125 dBm with Hewlett-Packard analyzers.

Variable persistence, digital storage, and adaptive sweep: high resolution and sensitivity both require narrow bandwidths and consequently slow sweep rates. Because of these slow sweeps, both digital display and variable persistence are virtually indispensable in providing a bright, steady flicker-free trace.

The digital storage feature on Hewlett-Packard analyzers covering audio to microwave frequency ranges make measurements and CRT photography simple. It gives the CRT display a dot matrix connected by line generators for an unbroken and uniform intensity scan. In addition, the microprocessor controlled analyzers feature CRT annotation to completely describe the data characteristics displayed.

On low frequency analyzers, adaptive sweep effectively speeds the measurement times. On the very slow sweep times (required when using the 1 Hz bandwidth), adaptive sweep allows the scan to sweep rap-

idly when no signals occur and slow down when a signal is above a preset level. The measurement time savings can be greater than 20:1.

Tracking Preselector

The only way to simultaneously avoid spurious, multiple, harmonic and image responses is to filter the RF signal through a tracking preselector. This is an electronically tuned bandpass filter that automatically tracks the analyzer's tuning. A preselector improves the spurious-free range of the analyzer from 70 dB to 100 dB.

Tracking Generator

A tracking generator expands the measurement capability of the spectrum analyzer by providing a signal source which tracks the tuning frequency of the analyzer. The source/receiver combination can be used to measure insertion loss, frequency response, return loss and allow precision frequency counting.

It helps make these additional measurements with increased distortion-free dynamic range, sensitivity and selectivity. The tracking generator is also an excellent stable sweeping generator. The residual FM varies from <1 Hz to <200 Hz for Hewlett-Packard tracking generators.

Automatic Spectrum Analyzers

The measurement capability of a spectrum analyzer can be greatly enhanced by allowing a desktop computer to control instrument functions and record frequency and amplitude information. Data can be gathered and processed into a variety of formats at a very rapid rate. Through comprehensive self-calibration, automatic spectrum analysis offers amplitude accuracy of up to ±0.4 dB with 0.01 dB resolution. User cost savings are realized through faster measurements, lower operator skill requirements, and unattended operation capability.

Further discussion of computer based automatic spectrum analysis can be found on page 490.

Frequency Stability Analysis

Frequency stability and spectral purity are important parameters when characterizing most signal sources. Long term stability or frequency drift due to aging or temperature effects is generally measured with a precision frequency counter such as the HP 5345A; random fluctuations in frequency or period can also be measured in the time domain, using an electronic counter and the Allan Variance technique.

Another measure of frequency stability is the phase spectral density. The most common method of making this measurement is to phase-lock the unknown to a clean reference source, mixing the two signals together in a phase detector and analyzing the low frequency output on a wave or spectrum analyzer. This technique allows the phase noise sidebands to be measured in the absence of the carrier, and can result in measurement sensitivities of -170 dBc or better.

Analog spectrum analyzers are required for noise measurement at high offset fre-

quencies (above 25kHz). However, at lower offsets (below approximately 100 Hz), their bandwidths become large in comparison to the frequencies being measured. In these cases, the use of FFT-based spectrum analyzers becomes necessary.

Insuring the accuracy of a phase noise measurement can be quite a problem. Non-ideal phase detectors and amplifiers will introduce measurement errors, and the phase-locked loop used to control the reference source will attenuate the noise signal at certain frequencies.

The HP 3047A Spectrum Analyzer system contains both a conventional and an FFT spectrum analyzer, and allows measurement of phase noise sidebands over the offset frequency range 0.02 Hz to 40 MHz. Phase detectors are provided for carriers from 5 MHz to 18 GHz, and require only an appropriate external reference source such as the 8662A. An extensive software package handles all operator interface, graphics and data storage, as well as complete error characterization and correction. Overall accuracy is an excellent ±2 dB. -170 dBc sensitivity is provided by a special low noise input amplifier. The 3047A Spectrum Analyzer System is described on page 520.

Fourier Analyzers

The Fourier analyzer uses digital signal processing techniques to provide measurement capability over and above that of a swept spectrum analyzer. Some of these include the precise measurement of random signals obscured by noise, measurement of the joint properties or relationships of two or more signals, measurements of statistical properties of signals, and measurements of very low frequency (e.g. below 5 Hz) or very closely spaced (e.g. less than 1 Hz) signals.

Fourier analyzers are based on the calculation of the Discrete Fourier Transform using a highly efficient algorithm known as the Fast Fourier Transform. As shown in Figure 2, this algorithm calculates the magnitude and phase of each frequency component from a block of time domain samples of the input signal.

The block diagram that is involved is shown in Figure 3. First, the input signal is filtered to remove out-of-band components. Next, the input is sampled and digitized at regular Δt intervals until a full block of samples called a time record has been collected. The processor then executes the desired series of computations on the time data to produce the frequency domain results. These results, which are stored in memory, can be analyzed on a CRT display, plotted, or processed further to provide the user additional useful information.

$$X(k \Delta f) = \sum \{x(n \Delta t) e^{-j2\pi(n)k/N}\}$$

EACH FREQUENCY POINT IS COMPOSED OF A MAGNITUDE AND PHASE VALUE EACH FREQUENCY POINT CONTAINS INFORMATION FROM ALL TIME DOMAIN SAMPLES COMPLEX FACTOR

Figure 2

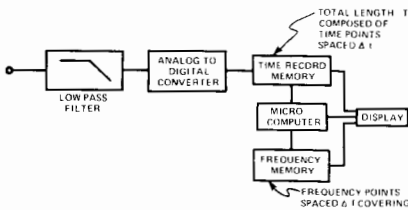

Figure 3

When two or more input channels are provided, signals can be sampled simultaneously. The processor can then additionally compute joint properties of the signals. This is useful for characterizing the transfer function of a linear device and for investigating cause/effect relationships.

The digital nature of Fourier analysis insures *high accuracy, stability and repeatability*. In addition, there are several specific advantages that are achieved.

Low Frequency Coverage

The Fourier transform calculates equally spaced frequency components from DC to the maximum frequency. By simply varying the sample rate it is possible to make measurements down to a few micro Hertz. For such low frequency measurements, the laws of physics dictate a long observation time. Since the Fourier transform simultaneously calculates all frequency points from one set of observation points, a one to two order of magnitude speed improvement over a swept measurement is possible.

High Frequency Resolution

By digitally translating a band of frequencies down to DC it is possible to provide very high frequency resolution over the entire range. This technique, known as Band Selectable Fourier Analysis, can provide resolution of a few millihertz as shown in Figure 4. Here a 5 Hz band of frequency located at 3 kHz is analyzed showing 0.48 Hz sidebands over 20 dB down.

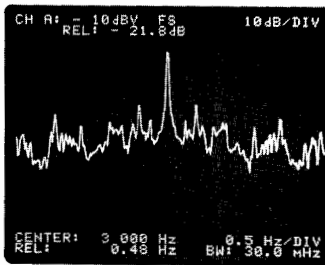

Figure 4

Direct Transfer Function Measurements

With simultaneous sampling of both the input and output of an electrical, mechanical, or acoustical system, it is possible to directly characterize transfer functions. Since the Fourier analyzer measures the frequency components simultaneously, energy must also be provided at these frequencies. This can be done with a broadband white noise signal, a pseudorandom noise signal or an impulse. Results presented in magnitude/phase or real/imaginary format help quickly illus-

trate the performance characteristics of a system.

The measurement of the coherence function can additionally provide a measure of the validity of a transfer function. It can distinguish portions of the output power that are not directly caused by the input, but may instead be due to additive noise, distortion products, or unmeasured inputs.

Systems Compatibility

Since the Fourier analyzer is basically all digital, interfacing to a computing controller or other digital peripherals is relatively simple. Remote programming and data input/output can considerably expand the range of potential applications.

Fourier Analyzer Applications

The versatility and performance of the Fourier analyzer make it an ideal tool for a variety of applications as a few specific examples will illustrate.

In the general area of electronics, the Fourier analyzer functions as a very high performance spectrum and network analyzer. It can be very useful for measuring phase noise or for characterizing filters.

In the field of communications, the Fourier analyzer can be very useful for characterizing audio signals, such as modems and touch tone signals.

When combined with a microphone the Fourier analyzer can be useful in characterizing acoustic devices, such as loud speakers.

With a motion transducer the Fourier analyzer can be used to analyze the vibration signatures of rotating machines. This can be very useful in helping to establish scientific maintenance policies.

The transfer function of a mechanical structure can illustrate how the structure responds to vibration inputs. This is extremely important in optimizing the design of structures that will be subjected to substantial vibration.

Wave Analyzers/SLM's

Wave analyzers are known by several different names: frequency selective voltmeter, carrier frequency voltmeter, and selective level meter. These names describe the instrument's function rather well.

As mentioned in the introduction to this section a wave analyzer can be thought of as a finite bandwidth window filter which can be tuned throughout a particular frequency range.

Signals will be selectively measured as they are framed by the frequency window. Thus, for a particular signal, the wave analyzer can indicate its frequency (window position) and amplitude. Amplitude is read on an analog meter; frequency is read on either a mechanical or electronic readout.

The uses of wave analyzers can be categorized into three broad areas: 1) amplitude measurement of a single component of a complex frequency system, 2) amplitude measurement in the presence of noise and interfering signals and, 3) measurement of signal energy appearing in a specified, well defined bandwidth.

Wave Analyzer/SLM Considerations

Frequency Characteristics

Range: should be selected with the future in mind as well as present requirements.

Accuracy and resolution: should be consistent with available bandwidths. Narrow bandwidths require frequency dial accuracy to place the narrow window in the proper position for measurement. Accuracy of instruments with selectable bandwidths is determined by the basic center frequency accuracy of the IF bandwidth filters in addition to the local oscillator frequency accuracy.

Readout: usually an LED display.

Stability: frequency stability is important when using narrow bandwidths and for long term signal monitoring. Stability is best achieved with automatic frequency control (AFC) or frequency synthesis. AFC locks the local oscillator to the incoming signal and eliminates any relative drift between the two. A frequency synthesized local oscillator allows frequency accuracy of $<1 \times 10^{-5}$ with 0.1 Hz resolution.

Sweep: some instruments are equipped with sweep to allow use as a spectrum analyzer. Readout is a CRT or X-Y recorder.

Amplitude Characteristics

Range: the amplitude range is determined by the input attenuator and the internal noise of the instrument. Sensitivity is defined as the lowest measurable signal equal to the noise level for a unity signal-to-noise ratio (often called tangential sensitivity). Sensitivity will vary with bandwidth and input impedance.

Dynamic range: defined as the dB ratio of the largest and smallest signals that can be simultaneously accommodated without causing an error in the measurement.

Attenuators: the amplitude range switch is an attenuator in the input and IF stages. Intermodulation distortion is lowest when the input amplifier has the minimum signal applied and the IF gain is greatest. Conversely the internal noise, important when making sensitive measurements, is lowest with maximum input signal and lowest IF gain. Newer instruments use auto-ranging techniques.

Accuracy: amplitude accuracy is a function of frequency, input attenuator response, IF attenuator performance, calibration oscillator stability and accuracy, and meter tracking. Often specifications are expanded to separately describe each contributor.

Readout: amplitude readout is usually a meter calibrated in dB and/or volts or a LED digital display. Linear voltage meters are used to allow the user to see down into the noise at the bottom of the scale. Digital readouts are often used with an analog meter to aid in tuning to signals. Expanded scale meters allowing expansion of any 1 or 2 dB portion of the scale into a full scale presentation allow resolution of input level changes of a few hundredths of a dB while LED displays allow .01 dB resolution. This is useful when the wave analyzer is used as a sensitive indi-



SIGNAL ANALYZERS

Wave, Distortion, Modulation, Spectrum and Fourier Analyzers (cont.)

ator in bridge or comparison measurements. The expanded scale meter is included in some instruments and is an optional accessory on others.

Input Characteristics

Impedance: may be high impedance bridging input or terminating impedance to match standard transmission lines. High frequency measurements require matched systems to avoid error-producing standing waves on interconnecting cables. The measure of impedance accuracy is usually return loss or reflection coefficient ($RL=20 \log \rho$). In low frequency instruments, percent accuracy is used. High input impedance instruments are usually poorer in high frequency and noise performance and are usually low frequency instruments. High impedance at high frequencies is accomplished by using a bridging probe to place the impedance at the point of measurement. The probe may be active with unity gain or passive with 20-30 dB insertion loss.

Input arrangement: input may be balanced to ground or unbalanced. Communications system usage typically requires balanced input. Standard 600 and 135/150 Ω balanced inputs are limited in frequency to less than 1 MHz and 124 Ω balanced to less than 10 MHz in most instruments. The impedance may be balanced to ground with the center point grounded or may be completely isolated from ground. Unbalanced inputs do not have frequency range limitations.

Network Analysis Application

Frequency response testing: with its tracking generator output, the wave analyzer is particularly useful for measuring filter and amplifier frequency responses. If a notch filter is being measured, for example, a narrow band measurement like that provided by a wave analyzer is essential for obtaining acceptable accuracy. A broadband technique will lead to some misleading results. For example, a notch filter may be driven with a flat oscillator and the response measured with a broadband voltmeter. The notch filter will reject the oscillator's fundamental tone, but pass its harmonics which are in the voltmeter's measurement range. Thus, an error results. If the voltmeter were frequency selective, like a wave analyzer, the harmonics would be rejected and the true level of the notch would be measured. Accurate and fast measurements can be made because Hewlett-Packard wave analyzers track and detect on the tracking generator frequency.

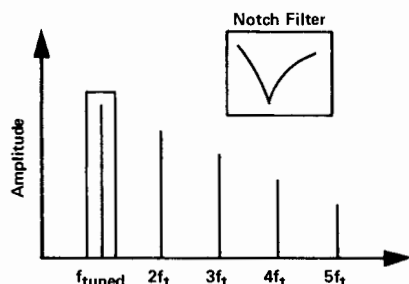

Only signal detected by wave analyzer. For example, the notch of a filter can be accurately measured to its full depth.

Distortion, Audio Analyzers

Harmonic distortion is one of many types of distortion created in communications equipment, audio and ultrasonic sound systems. Nonlinear elements in amplifiers cause harmonic related frequencies from a pure tone stimulus to be created at the output. Hence, to a listener, a poor reproduction quality becomes apparent. The total of these frequency components present in a signal, in addition to the fundamental frequency, can be measured quickly and easily with Hewlett-Packard distortion and audio analyzers.

The ratio of these frequency components to the amplitude of the fundamental is the total harmonic distortion (THD) as defined by the following equation (1):

$$THD = \frac{\sqrt{\sum (\text{harmonics})^2}}{\text{fundamental}}$$

The Hewlett-Packard distortion and audio analyzers consist of a narrow band rejection filter and broadband detector. Before the fundamental is rejected, the analyzer first measures the amplitude of the fundamental, all the harmonic components, and noise. Then the rejection filter is employed to remove the fundamental. The ratio of the two measurements is an approximation of equation (1) above and is defined by the following equation (2):

$$THD = \frac{\sqrt{\sum [(\text{harmonics})^2 + (\text{noise})^2]}}{\sqrt{\sum [(\text{fundamental})^2 + (\text{harmonics})^2 + (\text{noise})^2]}}$$

An approximation error of 1/2% can be expected for the THD levels of 10%. However, distortion levels as high as 10% are seldom encountered in most measurement situations. The harmonic content of the stimulus source must not be more than a third of the distortion expected to be caused by the system under test.

Audio Analyzers

The Audio Analyzer performs several basic low frequency measurements in addition to distortion, making it a general purpose audio test set. The audio analyzer includes the SINAD function for testing mobile radio receiver sensitivity. It contains a low distortion audio oscillator for stimulus response testing in combination with its distortion analyzer. It contains a true rms voltmeter and dc voltmeter for accurate measurement of complex waveform levels. Swept ac level and swept distortion measurements can be made when using the audio analyzer with a suitable X-Y recorder. Signal to noise ratio measurements are performed automatically when using the internal source and rms voltmeter. A reciprocal frequency counter is also included that continuously counts the frequency of the input signal.

These basic capabilities provide a general purpose instrument that represents high value in three major applications areas: 1) General audio component characterization, 2) radio transceiver audio measurements, 3) HP-1B systems. The Audio Analyzer provides sophisticated measurement capa-

bilities with significantly reduced operator interaction.

True Harmonic Distortion Measurements

The Hewlett-Packard desk-top computer controlled automatic spectrum analyzers provides the user a rapid means of measuring true harmonic distortion levels. The fundamental and its harmonic components are rapidly measured one at a time and the distortion is computed by applying equation (1). In production test situations, distortion calculations can be stored on tape for future reference and/or plotted for hard copy needs. Limit testing can also be applied.

Modulation Analyzers/Measuring Receivers

A modulation analyzer is a precision receiver, designed to detect the entire modulation envelope of a signal under test. It can measure and display the carrier characteristics of RF frequency and power as well as AM, FM and phase modulation characteristics such as AM depth, peak deviation, residual modulation, and various ratios associated with them. The modulation analyzer also faithfully recovers the actual modulating signal for further analysis such as distortion testing.

Applications for modulation analyzers center mostly in transmitter testing. The precision receiver capability allows comprehensive testing of the transmitter. All phases of design, production test, and maintenance of transmitters and their modules and subassemblies are applications. Because the measuring receiver can measure very low RF signal levels (to -127 dBm) as well as modulation and RF frequency, it is ideal for metrology and calibration labs for signal generator and attenuator calibration.

Capabilities

The unique measurement capabilities of modulation analyzers are easily shown on system tests with multiple-mode modulations such as simultaneous AM and FM. For example, if both amplitude and frequency modulation are present on a signal, a complex modulation spectrum is produced. To demonstrate this, an HP 8640B Signal Generator was 46.5% amplitude modulated with a 5 kHz triangular wave and 4.5 kHz peak frequency modulated with a 5 kHz sine wave simultaneously. The picture below shows the resulting signal as seen on a spectrum analyzer.

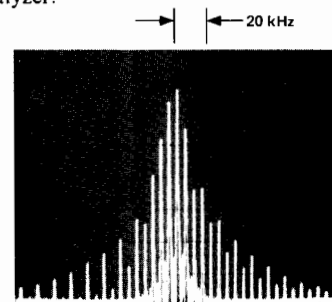

Spectrum Analyzer display of simultaneous AM (46.5%) and FM (4.5 kHz pk deviation) modulation.

Unequal, complex sidebands result and little data can be deduced. However, since a modulation analyzer faithfully recovers both modulation signals in independent detection systems insensitive to each other, it is easy to separate and read directly the various modulation components involved.

50000.184 MHz

46.5 %AM

9.942 - 3 Watts

4.49 kHz FM

Modulation Analyzer displays of RF signal parameters.

In addition, since the modulation analyzer handles the full complex modulation envelope, it measures and displays RF power and average frequency of the entire signal. The readings are all available at the push of a button.

The independent detection systems demodulate the waveforms. If further analysis is desired, the modulation analyzer characterizes audio signal level, frequency and dis-

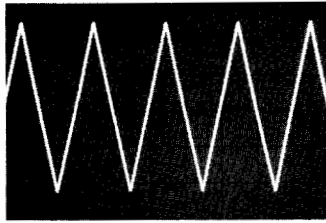

Recovered 5 kHz AM input signal viewed on oscilloscope.

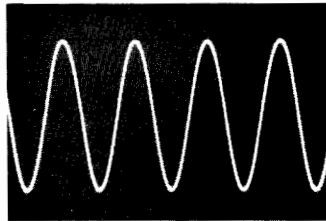

Recovered 5 kHz FM input signal.

ortion of both internally demodulated audio signals and external audio signals.

Since the AM and FM detection systems are independent and highly insensitive to each other, incidental modulation measurements can be made with high precision. For example, even with 90% amplitude modulation, the FM demodulator will accurately in-

dicade incidental FM. Such capability is valuable for design of oscillators, modulators, mixers and other components. It is very difficult to separate multiple modulation effects on spectrum analyzer displays because the effects are combined.

The HP 8901A/B Modulation Analyzers contain selectable filters to provide commonly used system characteristics for low-pass and high-pass filtering and FM de-emphasis. Thus measurement of transmitter modulation frequency response doesn't require additional equipment. Selectable detectors, including peak hold, allow measurements such as transmitter modulation limiting to be made very easily.

The measuring receiver can also serve as a high sensitivity, selective frequency counter and power meter. Since the superheterodyne design allows high sensitivity amplification of low level modulated signals, frequency counting of signals as low as -100 dBm is possible with good rejection of other signals.

Display and computational conveniences speed typical transmitter measurements and improve confidence in results. For example, ratio keys allow any measurement to be expressed in % or dB relative to any other measured or key-entered value. Such computations are valuable in applications such as mobile FM measurements, where hum and noise is expressed relative to an industry standard of 60% of maximum allowable deviation.

Signal Analyzers Selection Guide Spectrum Analyzers

Frequency Range	Amplitude Calibration Range	Bandwidths		Model Description	Companion Instruments	Page
		Min	Max			
0.02 Hz-25.6 kHz	-120 to +30 dBV	0.02 Hz	363 Hz	3582A Spectrum Analyzer		517
0.02 Hz-40 MHz (Extendable to 18 GHz)	-130 to +30 dBm	0.02 Hz	30 kHz	3047A Spectrum Analyzer (Direct Spectrum Mode)	8566A Spectrum Analyzer 8568A Spectrum Analyzer (Used as Downconverters)	520
0.02 Hz-40 MHz (Offset from Carrier) 5 MHz to 18 GHz (Carrier Range)	-170 dBc	0.02 Hz	30kHz	3047A Spectrum Analyzer (Phase Noise Mode)	8662A/8663A Synthesized Signal Generator 11729B Carrier Noise Test Set	520
5 Hz-50 kHz	-150 to +30 dBm	1 Hz	300 Hz	3580A Spectrum Analyzer		515
20 Hz-300 kHz	-142 to +10 dBm	10 Hz	10 kHz	8556A Tuning Section Plug-In ¹		504
10 Hz-13 kHz	-140 to +20 dBm	3 Hz	10 kHz	3044A Spectrum Analyzer		520
20 Hz to 40.1 MHz	-137 dB to +30 dBm	3 Hz	30 kHz	3585A Spectrum Analyzer		477
1 kHz-110 MHz	-140 to +10 dBm	10 Hz	300 kHz	8553B Tuning Section Plug-In ¹	8443A Tracking Generator	506
10 kHz-350 MHz	-117 to +20 dBm	1 kHz	3 MHz	8557A Spectrum Analyzer Plug-In ²		496
100 kHz-1250 MHz	-122 to +10 dBm	100 Hz	300 kHz	8554B Tuning Section Plug-In ¹	8444A Tracking Generator (500 kHz-1250 MHz)	508
100 kHz-1500 MHz	-117 to +30 dBm	1 kHz	3MHz	8558B Spectrum Analyzer Plug-In ²	8444A Opt. 059 Tracking Generator (500 kHz-1500 MHz)	498
100 Hz-1500 MHz	-137 dBm to +30 dBm	10 Hz	3 MHz	8568A Spectrum Analyzer and 8568S Automatic Spectrum Analyzer	8444A Opt. 059 Tracking Generator (500 kHz-1500 MHz) 85650A Quasi-Peak Adapter	484 490
10 MHz-21 GHz	-111 dBm to +30 dBm	1 kHz	3 MHz	8559A Spectrum Analyzer ²		500
100 Hz-22 GHz ³ (Extendable to 300 GHz)	-134 dBm to +30 dBm	10 Hz	3 MHz	8566A Spectrum Analyzer and 8566S Automatic Spectrum Analyzer	85650A Quasi-Peak Adapter 11970K/A/U Harmonic Mixers	487 490
10 MHz-22 GHz ³ (Extendable to 40 GHz and above)	-122 dBm to +30 dBm	100 Hz	3 MHz	8565A Spectrum Analyzer	8750A Storage-Normalizer 8444A Opt. 059 Tracking Generator (10 MHz-1500 MHz)	494
10 MHz-22 GHz ³ (Extendable to 115 GHz and above)	-123 to +30 dBm	100 Hz	3 MHz	8569B Spectrum Analyzer	8444A Opt. 059 Tracking Generator (10 MHz-1500 MHz) 11971K/A Harmonic Mixers	492
10 MHz-18 GHz (Extendable to 40 GHz and above)	-127 to +10 dBm	100 Hz	300 kHz	8555A Tuning Section Plug-In ¹	8444A Opt. 059 Tracking Generator (10 MHz-1500 MHz) 8445B Automatic Preselector (10 MHz-18 GHz)	510

NOTE 1: For use in display mainframes 140T and 141T with IF section plug-ins 8552A or 8552B (page 502).

NOTE 2: For use in display mainframes 853A, 180TR, 181T/TR and 182T.

NOTE 3: Frequency range extendable to 80 GHz through the use of the HP 11970 series Harmonic Mixers. For higher frequency coverage, other external mixers are commercially available.



SIGNAL ANALYZERS

Wave, Distortion, Modulation, Spectrum and Fourier Analyzers (cont.)

Modulation Analyzers/Measuring Receivers

Frequency Range	Modulation Measurements	Amplitude Measurement Range	Audio Frequency Count + Distortion Measurement	Model Number	Page
150 kHz-1300 MHz	AM, FM, Φ M	+30 to 0 dBm	No	8901A	530
150 kHz-1300 MHz	AM, FM, Φ M	+30 to -20 dBm	Yes	8901B	530
150 kHz-1300 MHz	AM, FM, Φ M	+30 to -127 dBm	Yes	8902A	532

Dynamic Signal Analyzers

Frequency Range	Amplitude Calibration Range	Resolution Points		Model Description	Functions Available	Page
		Min	Max			
DC-25 kHz	7 Steps From ± 0.1 to ± 10 V	256	32,000 (See Note 2)	5420B Digital Signal Analyzer 5423A Structural Dynamic Analyzer (See Note 3)	Time Average Linear Spectrum Auto Spectrum Transfer Function Coherence Function Histogram Correlation Impulse Response	523
0.1-25 kHz	7 steps from ± 0.125 to ± 8 V	256 PS 128 TF	1024 PS 512 TF	5427A Digital Vibration Control System (Analysis Mode)	Power Spectrum (PS) Transfer Function (TF) Transient Capture Shock Response Spectrum	525
0.02 Hz-25.6 kHz	9 steps from 3 mV to 30 V RMS	256	$> 1.3 \times 10^6$ (See note 2)	3582A Spectrum Analyzer	Voltage Spectrum Phase Spectrum Transfer Function Coherence Function Digital Averaging	517

NOTE 1: Standard range is DC to 50 kHz, expandable with options to 100 kHz.

NOTE 2: Equivalent number of points using Band Selectable Analysis.

NOTE 3: Also includes modal analysis capability.

Distortion / Audio Analyzers

Fundamental Frequency Range	Minimum Distortion	Auto Set Level	Auto Nulling	True RMS	AM Detector	Filters	Model No.	Internal Source	HP-IB	Page
5 Hz to 600 kHz	0.03% (-70 dB)		•		•	•	334A			528
			•		•	•	334A Opt 002			528
10 Hz-110 kHz	0.0018% (-95 dB)	•	•	•	•	•	339A	•		527
20 Hz-100 kHz	0.01% (-80 dB)	•	•	•	Note 1	•	8903A*	•	•	535

*The 8903A also performs Frequency Count, Signal/Noise, SINAD, watts, ac/dc volts measurements.

NOTE 1: The 8901A Modulation Analyzer (p. 530) provides complete demodulation of AM, FM, and Φ M signals.

Wave Analyzers/Selective Level Meters

Frequency Range	Selective Bandpass	Dynamic Range		Freq. Readouts	Type of Inputs	Type of Outputs	Modes of Operation	Model Number	Page
		Absolute	Relative						
15 Hz to 50 kHz	3 Hz 10 Hz 30 Hz 100 Hz 300 Hz	0.1 μ V-300 V full scale	> 85 dB	5-place digital	Banana Jacks	rec: 5 V full scale, with pen lift BFO, Local Oscillator, tuning loudspeaker, and headphone jack	AFC, normal, BFO	3581A/ 3581C	529 571
50 Hz to 32.5 MHz	20 Hz 400 Hz 3100 Hz	-130 to +20 dBm	> 80 dB	LED, 0.1 Hz Resolution	50/75 Ω , BNC 600 Ω Banana Jacks	Tracking Generator Audio/Loud Speaker 1 MHz Ref.	Wideband Selective USB/LSB	3586C (3336C*)	480 337
50 Hz to 32.5 MHz	20 Hz 400 Hz 1740/2000 Hz Optional 3100 Hz WTD	-130 to +20 dBm	> 70 dB	LED 0.1 Hz Resolution	75 Ω BNC/WECO 124 Ω WECO 135 Ω WECO 150 Ω Siemens 600 Ω WECO/ Siemens	Tracking Generator Audio/Loud Speaker 1 MHz Ref.	Wideband Selective SSB	3586A/B (3336A/B*) (3335A)	554 554 336

*Tracking Synthesizers.

SIGNAL ANALYZERS

20 Hz to 40 MHz Spectrum Analyzer

Model 3585A



- 80 dB dynamic range
- 3 Hz resolution bandwidth

- ± 0.4 dB amplitude accuracy
- Self-calibrating

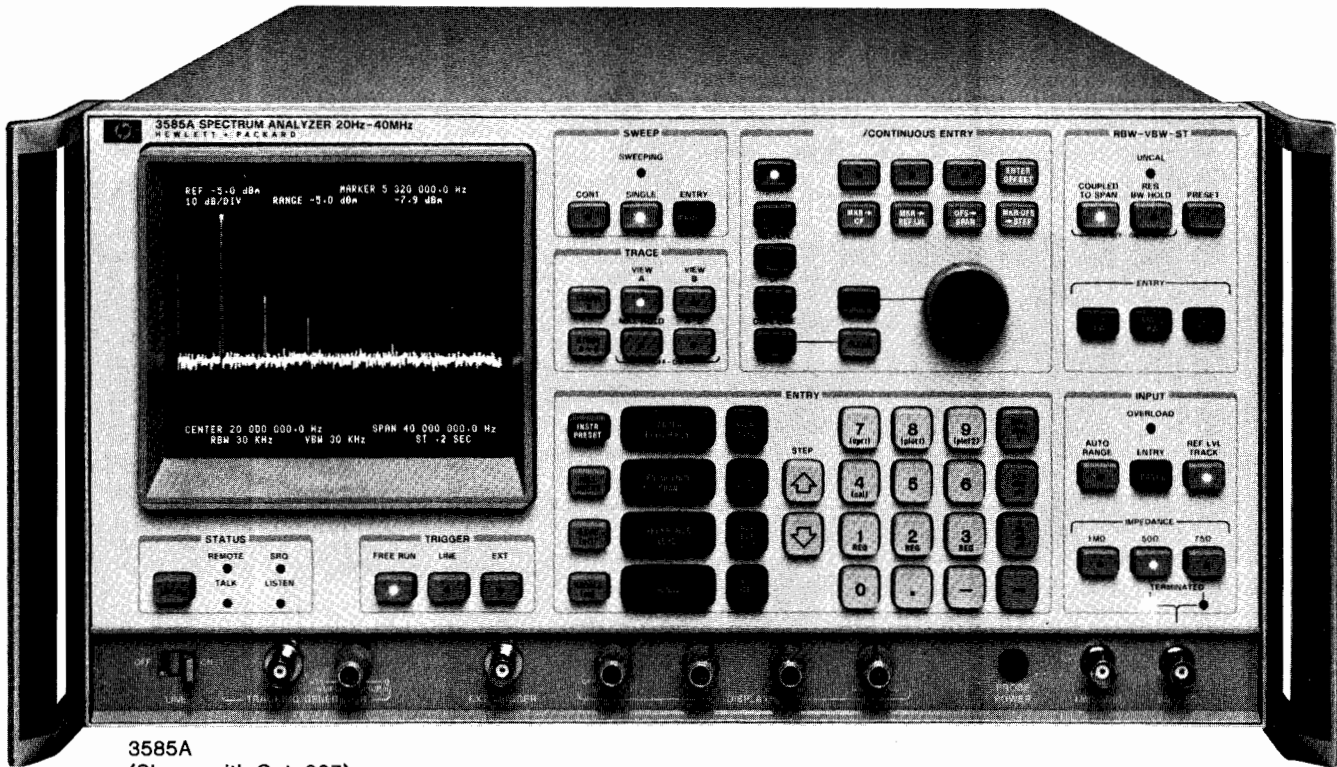

3585A
(Shown with Opt. 907)



Description

The HP 3585A Spectrum Analyzer has a fully synthesized local oscillator controlled by a microprocessor. The result of this state-of-the-art contribution offers outstanding performance over its frequency range of 20 Hz to 40.1 MHz. Center frequency and span settings have 0.1 Hz resolution and 1×10^{-7} /mo. stability over its entire operating range. The frequency precision and stability enables the 3 Hz resolution bandwidth filter to be used for close-in analysis even at 40 MHz.

An automatic internal calibration routine, administered by the microprocessor, provides up to ± 0.4 dB accuracy over most of the measurement range. Improvements in measurement performance of this magnitude cannot be realized by the user unless the basic limitations of the CRT display are bypassed. This has been accomplished by digitizing the detected video signal, which is then stored in memory. Photographic documentation of the display is greatly simplified by displaying all the essential frequency, amplitude and resolution parameters alpha-numerically around the edge of the CRT.

The power of the microprocessor provides a bonus by making this analyzer easier to use. Several of the usually tedious operations, such as centering a signal, raising it to the reference level, etc., are now simplified with dedicated key operated routines working in conjunction with the display marker. Adjustment of resolution and video bandwidth when modifying span is now an automatic function unless individual manual selection is required. In addition, new functions have been added, such as noise power density measurements and offset capability for both frequency and amplitude.

Measurement Power & Convenience

The power and convenience of the 3585A's microcomputer-based controls and CRT readout simplify and speed use in so many ways that previously impractical analyses now become routine. Functions such as center frequency and amplitude reference level may be keyboard-set with 0.1 Hz and 0.1 dB precision, varied with an 'analog' knob (actually a rotary pulse-generator), or incrementally key-stepped. The autoranging input attenuator eliminates the error-prone task of adjusting the attenuator to achieve the correct mixer level.

A tunable marker in the 3585A makes basic measurements precise and quick by directly measuring a signal or by speeding the process of magnifying the portion of the spectrum to be analyzed. With the marker set to the signal peak, signal amplitude and frequency (with counter accuracy) are numerically displayed on the CRT. A second marker makes relative measurements instantly available with numerical display of the difference in amplitude and frequency between the two markers. This is useful for modulation, distortion measurements, and bandwidth measurement. For example, in the case of telecommunications applications, the second marker can be set at harmonic or channel spacing from the first so the operator can simply step frequencies to track higher order harmonics or additional channels.

Amplitude and frequency may be offset to normalize values to some reference signal such as a pilot tone or to reflect the relative value of a signal. Other amplitude units, such as dBV or volts, can be chosen. On any occasion all settings can be stored, then later recalled with a short key sequence. As many as three sets of settings may be stored.



SIGNAL ANALYZERS

20 Hz to 40 MHz Spectrum Analyzer (cont.)

Model 3585A

Two different traces each of 1001 horizontal points, may be taken, stored in memory, then shown separately or together as desired while comparisons among them may be calculated and displayed digitally on the CRT. A Max Hold key causes the largest amplitude in successive sweeps to be displayed, making it easy to measure residual FM or drift. A built-in tracking generator, with a maximum output of 0 dBm, enables frequency response measurements to be made.

Automatic Measurements

Not only are all 3585A functions remotely-programmable via the HP Interface Bus (IEEE Standard 488-1975), the instrument also can be commanded to transfer its measurements out via the bus for interpretation and further interaction by a computing controller. The analyzer can be remotely tuned with the precision of the synthesizer, while retaining analog sweep and exceptional spectral purity. The result is a new and higher level of interaction between the user and the measurement system.

Frequency Accuracy

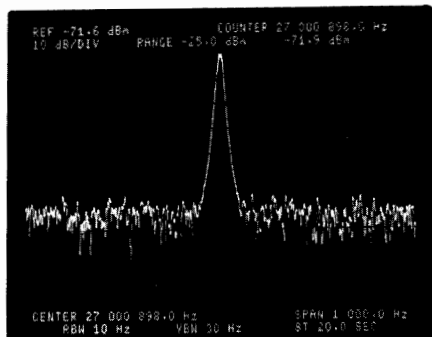

Counter measurements with spectrum analyzer selectivity and sensitivity can be made to 1×10^{-7} /mo. stability while sweeping or manually tuning.

Dynamic Range

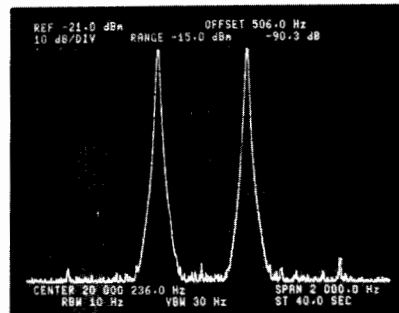

>80 dB spurious free dynamic range with full scale inputs of -25 dBm to +30 dBm in 5 dB steps. Autoranging input provides full dynamic range with no guesswork.

Internal Calibration

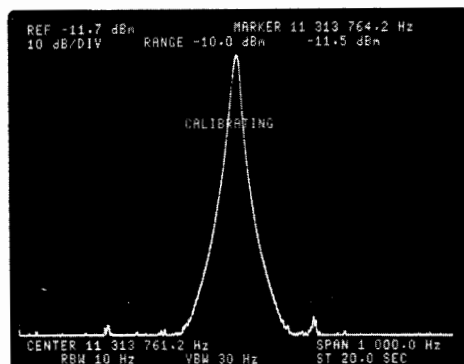

Maximum accuracy is assured at all times by an automatic internal calibration routine which compensates for frequency and amplitude errors in measurements made at the reference level at the center of the screen.

Swept Response Measurements

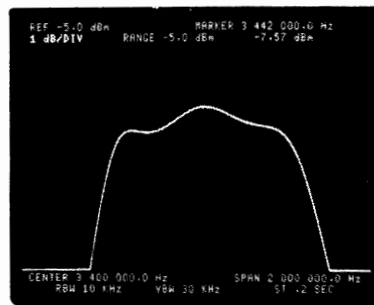

The built-in tracking generator offers superb stability and resolution for crystal filters as well as excellent flatness for wideband devices. The 1 dB/div. amplitude scale is used to expand and resolve small amplitude differences with .01 dB resolution using the marker readout.

Marker Aided Measurements

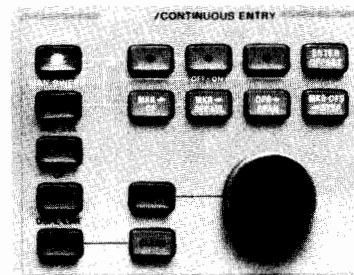

Along with the marker readout capability, there are three additional functions: counter measurements, noise level measurements, and offset (relative) measurements. The four operating aids just above the knob indicate that the marker or offset value can be directly entered into the center frequency, reference level, frequency span, or center frequency step size.

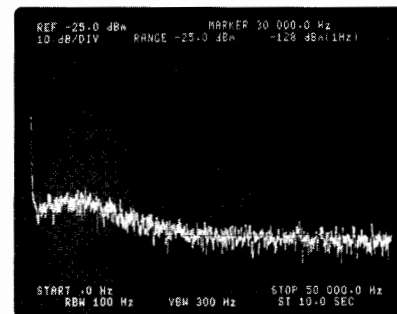

Noise Measurement

The noise level key displays RMS noise density normalized to a 1 Hz bandwidth at the marker position. All correction factors are accounted for in the internal measurement routine.

Terminal Interaction

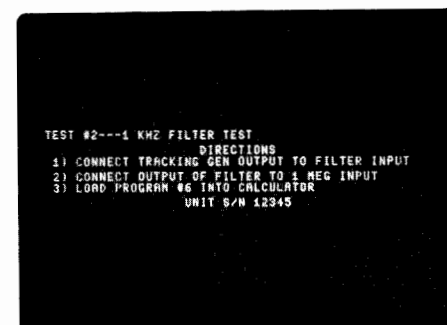

Measurement routines selected from the controller memory via the



analyzer keyboard, such as this filter test, can provide instructions to the operator to minimize errors and reduce training time for complex measurements.

Specifications

Frequency

Measurement range: 20 Hz to 40.1 MHz

Displayed Range

Frequency Span

Range: 0 Hz to 40.1 MHz variable with .1 Hz resolution or 10 Hz to 40 MHz in 1, 2, 5 steps

Accuracy: $-0\% + .2\%$ of frequency span setting

Center, Start/Stop, and Manual Frequency

Range: 0 Hz to 40.1 MHz with .1 Hz resolution

Accuracy: 1×10^{-7} /month of frequency

Marker

Readout accuracy: $\pm .2\%$ of frequency span \pm resolution bandwidth

Counter accuracy: $\pm .3$ Hz $\pm 1 \times 10^{-7}$ /month of counted frequency for a signal 20 dB greater than other signals and noise in the resolution bandwidth setting

Resolution

Resolution Bandwidths

Range: 3 dB bandwidths of 3 Hz to 30 kHz in a 1, 3, 10 sequence

Accuracy: $\pm 20\%$ at the 3 dB points

Selectivity: 60 dB/3 dB $< 11:1$

Amplitude

Measurement range: -137 dBm to $+30$ dBm (50/75 Ω) or equivalent level in dBV or volts, 31 nV to 22 V (1 M Ω)

Displayed Range

Scale: 10 division CRT vertical axis with Reference Level at the top graticule line

Calibration: 10, 5, 2 and 1 dB/division from the Reference Level

Input range: -25 dBm to $+30$ dBm in 5 dB steps

Reference Level (relative to input range)

Range: -100 dB to $+10$ dB

Accuracy (using 1 or 2 dB/div., at midscreen with sweep rate reduced by 4 or at the manual frequency)

50/75 Ω Input

+10 dB	-50 dB	-70 dB	-90 dB
$\pm .4$ dB	$\pm .7$ dB	± 1.5 dB	

1 M Ω Input - add to above

20 Hz	10 MHz	40.1 MHz
$\pm .7$ dB	± 1.5 dB	

Amplitude Linearity (referred to reference level)

0 dB	-20 dB	-50 dB	-80 dB	-95 dB
$\pm .3$ dB	$\pm .6$ dB	± 1.0 dB	± 2.0 dB	

Frequency Response (referred to center of span)

50/75 Ω input: $\pm .5$ dB

1 M Ω Input

20 Hz	10 MHz	40.1 MHz
$\pm .7$ dB	± 1.5 dB	

Marker

Amplitude Accuracy

Midscreen at the reference level: use Reference Level accuracy from $+30$ dBm to -115 dBm, add Amplitude Linearity below -115 dBm.

Anywhere on screen: add Reference Level Accuracy, Amplitude Linearity and Frequency Response.

Dynamic Range

Spurious Responses (image, out of band, and harmonic distortion)

50/75 Ω input: < -80 dB referred to a single signal equal to or less than Input Range

1 M Ω input: < -80 dB except second harmonic distortion < -70 dB

Intermodulation Distortion

50/75 Ω input: < -80 dB referred to the larger of two signals

each ≥ 6 dB below Input Range except 2nd order IM from 10 MHz to 40 MHz < -70 dB

1 M Ω input: < -70 dB

Residual responses (no signal at input): < -120 dBm using -25 dBm range

Average Noise Level

50/75 Ω Input

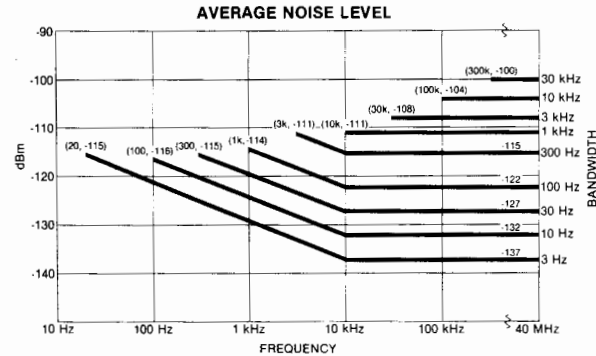

1 M Ω input: Below 500 kHz add 12 dB to above

Sweep

Modes: continuous, single or manual

Trigger: free Run, Line, or External

Time: .2 s full sweep to 200 s/Hz of Frequency Span (swept time excluding auto calibration cycles)

Input

Signal Inputs

50/75 Ω : > 26 dB return loss, BNC connector

1 M Ω : $\pm 3\%$ shunted by < 30 pf, BNC connector

Maximum Input Level

50/75 Ω : 13 V peak ac plus dc relay protected against overloads to 42 V peak.

1 M Ω input: 42 V peak ac plus dc (derate by factor of two for each octave above 5 MHz).

External trigger input: negative going TTL level or contact closure required to initiate sweep.

External reference input: 10MHz (or subharmonic to 1 MHz), 0 dBm minimum level

Output

Tracking Generator

Level: 0 dBm to -11 dBm with a single turn knob

Frequency accuracy: ± 1 Hz relative to analyzer tuning

Frequency response: $\pm .7$ dB

Impedance: 50 Ω ; > 14 dB return loss

Probe power: $+15$ Vdc, -12.6 Vdc; 150 ma max.

Suitable for powering HP 1120A Active Probe

External Display

X, Y: 1 volt full deflection; **Z:** < 0 V to > 2.4 V

Recorder:

X Axis: 10 V full scale

Y Axis: 10 V full scale

Z — penlift output TTL

IF: 350 kHz, -11 dBV to -15 dBV at the reference level

Video: 10 V at the reference level

Frequency reference: 10.000 MHz $\pm 1 \times 10^{-7}$ /mo., $+10$ dBm into 50 Ω

General

Environmental

Temperature: operating 0°C to 55°C

Humidity: $< 95\%$ RH except 300 Hz BW $< 40\%$ RH

Warm-up time: 20 minutes at ambient temperature

Power requirements: 115 V ($+11\%$ -25%), 48–440 Hz

230V ($+11\%$ -18%), 48–66 Hz

180 Watts 3A max

Weight: 39.9 kg (88 lb.)

Size: 22.9 cm (9") H \times 42.6 cm (16.75") W \times 63.5 cm (25") D

Ordering Information

Opt. 907: Front Handle Kit

Opt. 908: Rack Flange Kit

Opt. 909: Combined Opt. 907 and 908

Opt. 910: Extra Manual

Model 3585A Signal Analyzer



SIGNAL ANALYZERS

50 Hz to 32.5 MHz Selective Level Meter

Model 3586C

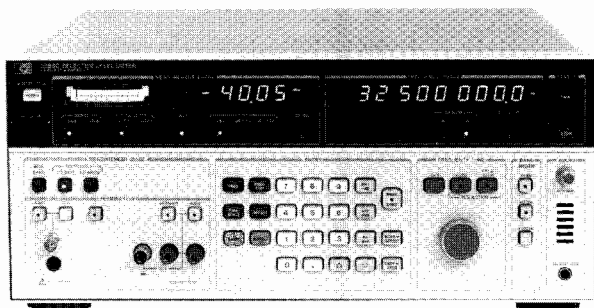

3586C



Description

The 3586C selective Level Meter is designed for general purpose wave analysis applications in the design, manufacture, and maintenance of electronic systems.

Microprocessor control and HP-developed fractional-N synthesis provides precise frequency setting and time saving ease-of-use features, and the 3586C is fully HP-IB programmable.

The 3586C Selective Level Meter covers the frequency range from 50 Hz to 32.5 MHz allowing measurement of audio, sonar, and other low frequency systems as well as high frequency communications and sub-systems. Input impedances of 50, 75, or 600 Ω with 10 k Ω bridging adds measurement flexibility for a wide variety of applications.

Wideband power measurements can be made up to 32.5 MHz and down to -45 dBm. Measure selectively in LO Distortion or LO noise modes or use USB or LSB for single sideband demodulation of a carrier.

Measurement Precision

Signal levels are measured with up to ± 0.2 dB accuracy down to -80 dBm with .01 dB resolution and bandwidth choices of 20, 400, or 3100 Hz. Automatic level calibration eliminates the need for manual calibration operations prior to critical level measurements. Frequency can be set precisely with 0.1 Hz resolution and $\pm 1 \times 10^{-5}$ stability ($\pm 2 \times 10^{-7}$ optional). The built-in frequency counter allows you to measure the frequency of a signal greater than -100 dBm within the filter bandwidth chosen and then tune the center of the filter passband precisely to that signal with one keystroke.

Selective Measurements

Make measurements on signals as close as 80 Hz spacing with 50 dB rejection using the 20 Hz filter. Use the extremely selective 3100 Hz filter for telecommunications channel level or noise measurements with 60 dB carrier rejection and 75 dB adjacent channel rejection, or demodulate the upper or lower sideband signal for further processing and listen to it with the speaker output.

Digital or Analog Frequency Control

Frequencies may be entered directly on the keyboard with 0.1 Hz resolution and then changed by entering any step size and stepping up or down in frequency, or use the analog frequency tune control. The analog frequency tune control will change frequency in automatically chosen steps proportional to the bandwidth chosen, or in the step size entered.

Tracking Synthesizer

The 3586C will operate in the frequency tracking mode with either the 3336C Synthesizer (see page 337) for measurements up to 20.9 MHz, or the 3335A Synthesizer (see page 336) for full frequency coverage up to 32.5 MHz. The tracking synthesizer will automatically tune to the frequency programmed on the 3586C in the tracking mode when their HP-IB interfaces are connected together with a bus cable.

Use the tracking mode to save time in amplitude-only network analysis or for loop-around measurements in telecommunications systems.

Frequency Response Measurements

The 3586C includes a rear panel tracking output of approximately 0 dBm amplitude and $\pm .5$ dB flatness at the same frequency as the passband center frequency. The tracking output has the same accuracy, stability and resolution as the 3586C center frequency specifications. This means the tracking output can be used for frequency response testing of high-Q filters and other selective networks. External attenuators can be used to adjust the input and output levels of the device under test to acceptable ranges.

For applications requiring improved amplitude accuracy and flatness, full amplitude range control without external attenuators, or better signal purity, use the 3336C or 3335A tracking synthesizer in place of the 3586C tracking output. By automatically tracking the frequency of the 3586C, the tracking synthesizers improve the accuracy and flexibility of frequency response measurements without increasing the measurement time.

Distortion Measurements

The front panel convenience features of the 3586C allow fast, accurate measurement of individual harmonic levels. To measure harmonic levels relative to the fundamental, first measure the fundamental signal level, and enter that level as an offset. Then, enter a frequency step size equal to the fundamental frequency. Now you can quickly step to the harmonic frequencies and measure the harmonic distortion directly without time-consuming calculations. When the exact fundamental frequency is unknown, the built-in counter can be used to measure the fundamental frequency, thereby ensuring precise tuning and accurate measurement.

Intermodulation distortion can also be measured quickly by storing the intermod frequencies and front panel settings in the non-volatile storage registers of the 3586C.

Verifying the total harmonic distortion specifications of sources and amplifiers is a laborious measurement unless a special purpose distortion analyzer is used. With a simple routine in a controller such as the HP 85F Personal Computer, the HP 3586C can be used to quickly measure total harmonic distortion as well as individual harmonic levels.

TOTAL HARMONIC DISTORTION TEST	
FUNDAMENTAL FREQ	ABSOLUTE AMP
10.805.1 Hz	1.18 dBm
HARMONIC FREQ	RELATIVE AMP
2 21.610.2 Hz	-50.65 dB
3 32.415.3 Hz	-50.36 dB
4 43.220.4 Hz	-72.35 dB
5 54.025.5 Hz	-50.55 dB
6 64.830.6 Hz	-67.73 dB
THD = -46.89 dB OR 0.45 %	

The 3586C and an HP computer were used to characterize a function generator for total harmonic distortion as well as harmonic level.

3586C Specifications

Frequency

Frequency range: 50/75 Ω Unbalanced Input; 50 Hz to 32.5 MHz, 600 Ω Balanced Input; 50 Hz to 108 kHz

Frequency resolution: 0.1 Hz

Center frequency accuracy: ±1 x 10⁻⁵/year, (±2 x 10⁻⁷/year with option 004).

Counter accuracy: ±1.0 Hz in addition to center frequency accuracy for signals within the 60 dB bandwidth of the IF filter chosen or greater than -100 dBm (largest signal is measured).

Frequency display: 9 digit LED

Selectivity

3 dB bandwidth,* ±10%: 20 Hz, 400 Hz, 3100 Hz

*Noise bandwidth is the same as the 3 dB bandwidth

60 dB bandwidth: 3100 Hz BW, ±1850 Hz; 400 Hz BW, ±1100 Hz; 20 Hz BW, ±90 Hz

Adjacent channel rejection: 75 dB minimum at ±2850 Hz, 3100 Hz BW

Passband flatness ±0.3 dB

Passband Flatness

Bandwidth	Flatness Range	Flatness
3100 Hz	±1000 Hz	±0.3 dB
400 Hz	± 50 Hz	
20 Hz	± 3 Hz	

Amplitude

Measurement range: +20 to -120 dBm

Amplitude resolution: .01 dB

Level accuracy: 10 dB auto range, low distortion mode, after calibration, signal at ±1 Hz from center frequency.

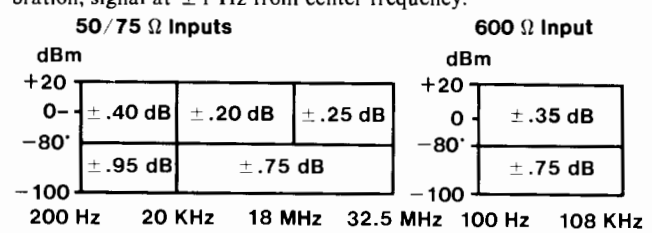

*20 Hz & 400 Hz BW below -90 dBm

Level accuracy: 100 dB Range (after calibration), add correction to 10 dB auto range accuracy for dB below full scale. (Not required when in 10 dB auto-range.)

dB Below Full Scale	Accuracy Correction
0 to -20 dB	±.25 dB
-20 to -40 dB	±.50 dB
-40 to -80 dB	±2.0 dB

Wideband power accuracy: after calibration, 100 dB range, average on, -45 to +20 dBm.

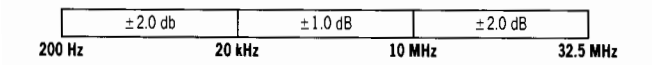

Dynamic Range

Spurious Responses

-110 dBm maximum or the following, whichever is greater.

Image rejection (100-132 MHz): -80 dBc

IF rejection: 15625 Hz, -80 dBc; 50 MHz, -60 dBc

Spurious signals: > 1600 Hz offset, > -80 dBc; 300 Hz to 1600 Hz, > -75 dBc

Residual spurious: -110 dBm maximum; <350 Hz, -95 dBm

Distortion

Harmonic distortion: -75 dB below full scale, low distortion mode, above 4 kHz.

Intermodulation distortion: two-tone second and third order, separation 10 kHz to 1 MHz, -78 dB below full scale. Either tone ≥ 10 MHz, -70 dB.

Noise Floor (full scale setting -35 to -120 dBm)

Frequency	Bandwidth	Noise Level
100 kHz to 32.5 MHz	3100	-114 dBm
	20 Hz, 400 Hz	-120 dBm
2 kHz to 100 kHz	All	-105 dBm

The noise floor for full scale settings of -30 to +25 dBm will be 75 dB below full scale for >100 kHz, or 55 dB below full scale for <100 kHz.

Signal Inputs

Impedance	Frequency	Mating Connector
50/75 ohms unbalanced 600 ohms balanced	50 Hz to 32.5 MHz 50 Hz to 108 kHz	BNC Dual Banana Plug 0.75 inch Spacing

Return loss: 50/75 Ω, 30 dB; 600 Ω, 25 dB

Balance: 600 Ω; 40 dB

Demodulated Audio Output

Output level: 0 dBm into a 600 Ω load

Output connector: 1/4" jack, mates with WECO 347.

Auxiliary Signal Inputs/Outputs

Tracking output: 0 dBm rear panel tracking output

Ext. reference input: 1 MHz to 10 MHz or sub-harmonic input.

Reference output: 10 MHz at 8 dBm output (also 10 MHz oven oscillator on instruments with option 004).

Probe power: front panel DC output for HP active high impedance accessory probes, (+15, -12 VDC)

HP-IB interface: rear panel interface meeting IEEE 488-1978 for remote operation. Used for tracking synthesizer interface.

Additional outputs: audio, phase jitter and meter output.

Options

Option 004: High stability frequency reference: 10 MHz oven stabilized reference oscillator, improves frequency stability to ±2 x 10⁻⁷/year.

General

Operating Environment

Temperature: 0° to 55°C

Relative humidity: 95%, 0° to 40°C

Altitude: ≤15,000 ft., ≤4600 metres

Storage environment temperature: -40°C to 75°C

Storage altitude: ≤50,000 ft., ≤15,240 metres

Power: 100/120/220/240 V, +5%, -10%, 48 to 66 Hz, 150 VA

Weight: 23 kg. (50 lbs.) net; 30 kg. (65 lbs.) shipping

Size: 177 mm H x 425.5 mm W x 475.5 mm D (7" x 16.75" x 16.75")

3586C Selective Level Meter*

Opt 004: High Stability Frequency Reference

Opt 907: Front Panel Handles

Opt 908: Rack Flange Kit

Opt 909: Rack Flange & Handle Combination Kit

Accessories

1124A: High Impedance Probe

*HP-IB cables not supplied. See page 37.

SIGNAL ANALYZERS

Spectrum Analyzers, 100 Hz to 300 GHz

Models 8568A & 8566A

- 100 Hz to 1.5 GHz coverage with counter accuracy
- 10 Hz resolution bandwidth
- Trace markers with amplitude and frequency readout

- 100 Hz to 300 GHz coverage with synthesizer accuracy
- 2 to 22 GHz preselected range
- Comprehensive HP-IB capability

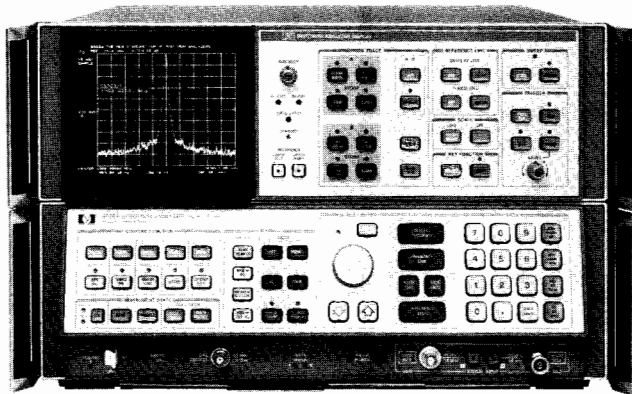

8568A

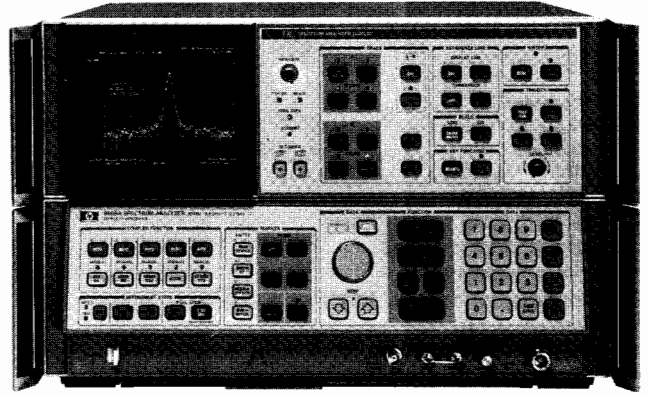

8566A



The 8568A and 8566A are high performance spectrum analyzers for bench and HP-IB system use. The 8568A operates over the 100 Hz to 1500 MHz frequency range, the 8566A operates over a 100 Hz to 22 GHz internal mixing range with preselection from 2 GHz to 22 GHz. The frequency range may be extended to 60 GHz with the Option E70 External Mixer Set (see page 513 for specifications of the 11970 series external mixers) and to 300 GHz with commercially available external mixers. (For more information on external mixing, see Product Note 8566A-1 or contact your local HP field engineer). Each analyzer is designed around its own internal bus and controlled by its own microcomputer to yield significant improvements in RF measurement performance, new operational features, and unparalleled flexibility under program control.

The performance specifications for the 8568A and 8566A are described on pages 484 and 487.

Performance

Exceptional frequency stability in both the 8568A and 8566A enables the use of a 10 Hz resolution bandwidth over their respective frequency ranges. Superior spectral purity and narrow resolution make it possible to measure clean oscillators directly at RF frequencies. 10 Hz resolution also results in sensitivities to -135 dBm which makes greater than 85 dB spurious-free dynamic range achievable. A frequency reference error of 1×10^{-9} /day together with the analyzers' resolution and sensitivity allow small signals in the presence of large ones to be measured with unequalled accuracy.

Usability

All the control settings are conveniently read on the CRT display. The operator changes control settings through the data controls. To activate a function the user pushes the appropriate key; he then has the option of setting the function's value using the knob, step keys or numeric/unit keyboard.

Measurements can be made following conventional "zoom" techniques using the center frequency, frequency span and reference level

functions, or with the help of certain measurement aids. A preset button sets all analyzer controls to a convenient starting point; coupled functions, such as resolution bandwidth and sweep time change automatically as frequency span is reduced to maintain a calibrated display.

A tunable marker is available for directly measuring a signal or speeding the process of magnifying the portion of the spectrum to be analyzed. With the marker set to the signal peak, the signal's *amplitude* and *frequency* are displayed on the CRT. A second marker, useful for modulation or distortion measurements, makes relative measurements by displaying the difference in amplitude and frequency between the two markers. Marker information enables the operator to step between evenly spaced portions of the frequency spectrum such as communication channels or signal harmonics; the noise level at the marker can be converted to the RMS noise density normalized to a 1 Hz bandwidth. The marker may also be positioned at the peak of the largest signal on the screen and used to zoom-in on signals *automatically*.

Once the analyzer's controls have been adjusted, all settings can be *saved* in memory and later *recalled* to repeat the measurements. An internal battery maintains the contents of memory in the event of a power failure.

All displayed information resides in a digital memory from which the CRT is refreshed at a flicker-free rate. Display titles may be added. A trace may be viewed real-time or stored; max hold displays the largest amplitude at 1001 points across the CRT over successive sweeps to aid in the measurement of residual FM or drift. Up to three traces may be observed simultaneously and arithmetic between traces or a trace and reference display line is possible for comparison or frequency response normalization.

Automatic Measurement Capability

The 8568A and 8566A analyzers lend themselves to automatic control via the HP Interface Bus (IEEE Standard 488-1975). The analyzers can be tuned with the precision of a synthesizer while retaining analog sweep and exceptional resolution. The analyzers' control ar-

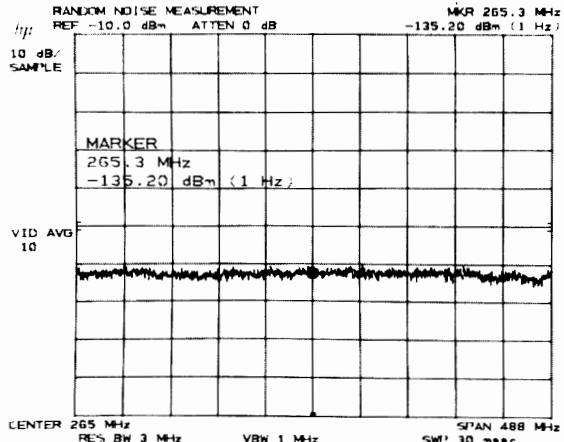
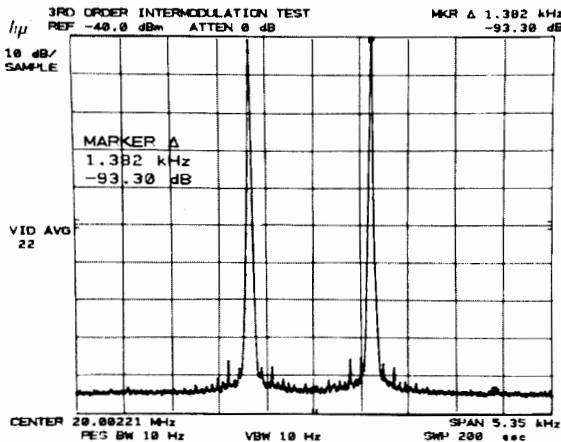
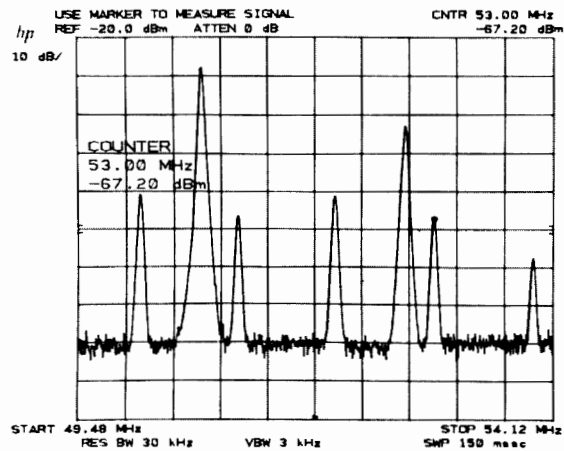
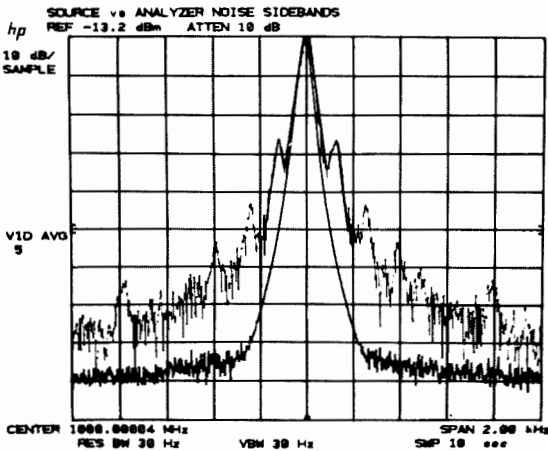
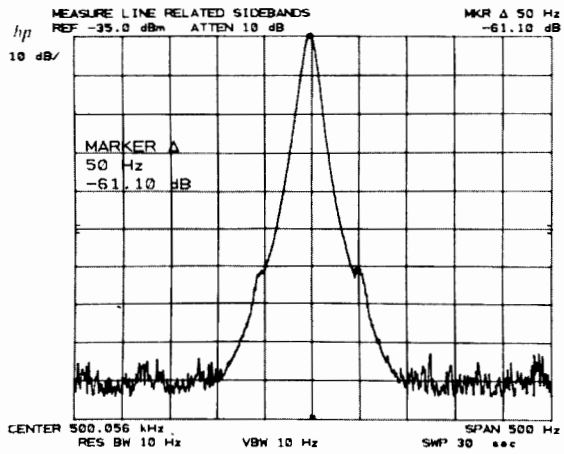
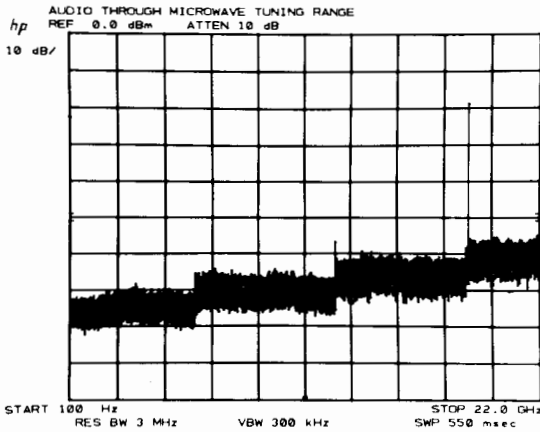

chitecture facilitates the remote operation of all function settings and the output of CRT trace information; the display itself is accessible for annotation and graphing purposes.

Friendly analyzer codes and HP-IB commands are used to program the analyzer; for example, CF 20 MZ instructs the analyzer to set center frequency to 20 MHz. Built-in firmware features such as instrument preset, peak search and automatic zoom further simplify writing software.

The primary advantage of computer control is the execution of complicated or time consuming measurement routines with a minimum of involvement by the operator. This capability is especially useful in production line testing or unattended measurement situations such as spectrum monitoring. An analyzer may be joined by other instruments in a distributed system, or be controlled remotely through a data communications network. External control is desirable for setting the proper analyzer function values, reading data, performing any numerical manipulation required (including error

correction), analyzing the results, and providing output data in a convenient format on a printer, plotter, or the analyzer CRT.

Operation Training Course HP 8566A + 24D or 8568A + 24D

This four day course is designed for engineers and senior technicians who will be integrating the 8566A or 8568A Spectrum Analyzers into their own automatic test systems. The course teaches manual and remote operation techniques using the HP 9826A Computer and HP-IB. The use of interactive lectures, hands-on oriented labs and small class size give students a solid understanding of spectrum analyzer remote measurement capabilities. Contact your local HP sales office for enrollment information.

Automatic capability is available in two configured systems, the 8568S and 8566S Automatic Spectrum Analyzers. These are specified on page 490.

SIGNAL ANALYZERS

Spectrum Analyzer, 100 Hz to 1500 MHz

Model 8568A

- 100 Hz to 1.5 GHz frequency range
- 10 Hz resolution bandwidth
- Frequency counter accuracy
- Digital display
- Tunable marker with amplitude and frequency readout
- Store and recall of control settings

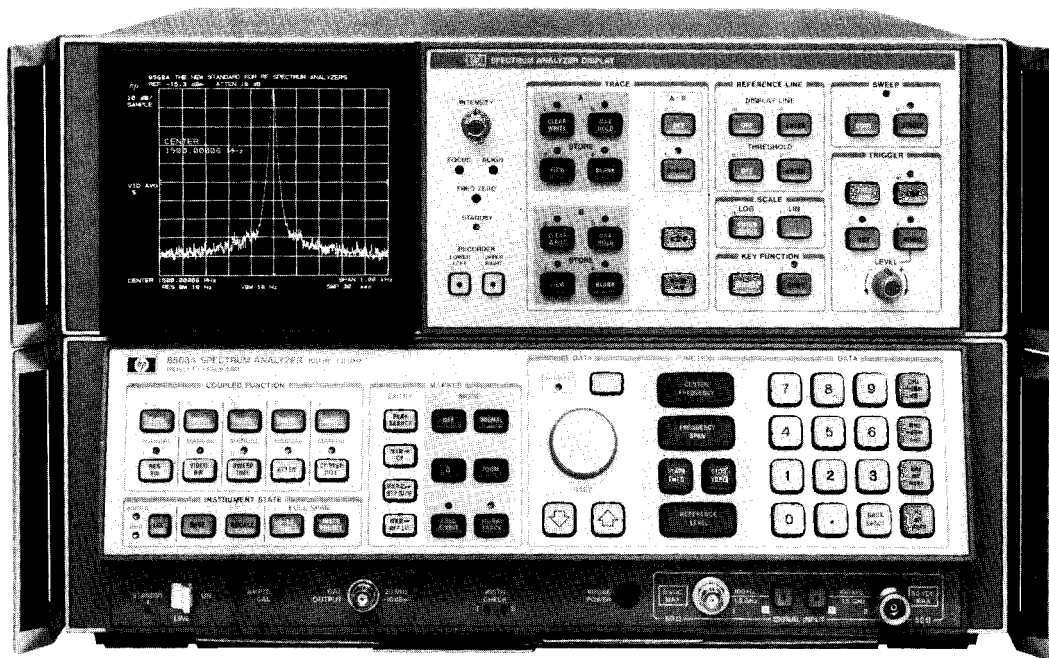

DESIGNED FOR
HP-IB
SYSTEMS

The 8568A Spectrum Analyzer is a high performance spectrum analyzer for bench and remote operation which covers the 100 Hz to 1.5 GHz frequency range. Frequency stabilized local oscillators and an internal counter bring unequalled measurement precision to RF spectrum analysis. Exceptional frequency stability and local oscillator spectral purity enables the use of a 10 Hz resolution bandwidth to make difficult, close-in sideband measurements on RF signals.

An internal microprocessor opens new horizons of operator convenience features. Digital display, store and recall of control settings, automatic zoom-in and signal track functions are administered by powerful firmware within the 8568A, thus simplifying operation of the analyzer.

All 8568A functions are programmable via HP-IB (IEEE 488-1975). Programming is as straightforward as encoding the steps used in a manual measurement. Friendly programming codes and easily recognizable mnemonics facilitate learning the analyzer language.

8568A Specifications

Frequency

Displayed Range

Frequency span: 100 Hz to 1500 MHz over 10 division CRT horizontal axis. In zero span, the instrument is fixed tuned at the center frequency.

Full span (0-1500 MHz): is immediately executed with a 0-1.5 GHz or INSTR PRESET keys.

Frequency span accuracy: for spans >1 MHz, $\pm(2\%$ of the indicated frequency separation between two points +0.5% span); for span ≤ 1 MHz, $\pm(5\%$ of frequency separation +0.5% span).

Center frequency: 0 Hz to 1500 MHz. Center frequency step size may be set using the numeric keyboard or MKR/ Δ —STP SIZE key.

Readout accuracy: span ≥ 100 Hz: $\pm(2\%$ of frequency span + frequency reference error \times tune frequency +10 Hz) in AUTO resolution bandwidth after adjusting freq zero at stabilized temperature, and using the error correction function, SHIFT W and SHIFT X.

Start-stop frequency: permissible values must be consistent with those for center frequency and frequency span. SHIFT O sets the analyzer start and stop frequencies equal to the frequencies of the two Δ markers.

Readout accuracy: center frequency accuracy + $\frac{1}{2}$ frequency span accuracy.

Marker

Normal: displays the frequency at the horizontal position of the tunable marker.

Accuracy: center frequency accuracy + frequency span accuracy between the marker and center frequencies.

PEAK SEARCH positions the marker at the center of the largest signal response present on the display to within $\pm 10\%$ of resolution bandwidth. MKR \rightarrow CF sets the analyzer center frequency equal to the marker frequency; MKR/ Δ \rightarrow STP SIZE sets the center frequency step equal to the marker frequency.

Frequency count: displays the frequency signal on whose response the marker is positioned. The marker must be positioned at least 20 dB above the noise or the intersection of the signal with an adjacent signal and more than four divisions up from the bottom of the CRT.

Accuracy: for span ≤ 100 kHz: frequency reference error \times displayed frequency ± 2 counts. For span >100 kHz but ≤ 1 MHz: freq. ref. error \times displayed frequency $\pm(10$ Hz + 2 counts). For span >1 MHz: $\pm(10$ kHz + 1 count).

Frequency reference error: aging rate $< 1 \times 10^{-9}$ /day; temp stability $< 7 \times 10^{-8}$, 0° to 55°C (after 30 day warm-up).

Signal track: re-tunes the analyzer to place a signal identified by the marker at the center of the CRT and maintain its position. Useful when reducing frequency span to zoom-in on a signal; also keeps a drifting input signal centered.

Δ : displays the frequency difference between the stationary and tunable markers. Reference frequency need not be displayed.

Accuracy: same as frequency span accuracy; in the FREQ COUNT mode, twice the frequency count uncertainty plus drift during the period of the sweep (typically < 10 Hz/minute). MKR/ Δ \rightarrow STP SIZE sets the center frequency step size equal to the frequency difference between the markers. SHIFT O sets the analyzer start stop frequencies equal to the frequencies of the two markers.

Zoom: makes it possible to reduce the frequency span about the marker (or signal in the signal track and freq count modes) using the step down key.

Resolution

Resolution bandwidth: 3 dB bandwidths of 10 Hz to 3 MHz in a 1, 3, 10 sequence. Bandwidth may be selected manually or coupled to frequency span.

Bandwidth accuracy: calibrated to: $\pm 10\%$, 1 MHz to 3 kHz; $\pm 20\%$, 1 kHz to 10 Hz, 3 MHz bandwidths.



Bandwidth selectivity: 60 dB/3 dB bandwidth ratio: <15:1, 3 MHz to 100 kHz; <13:1, 30 kHz to 10 kHz; <11:1, 3 kHz to 30 Hz. 60 dB points on 10 Hz bandwidth are separated by <100 Hz.

Stability

Residual FM: <3 Hz peak-to-peak for sweep time ≤ 10 sec; span <100 kHz, resolution bandwidth ≤ 30 Hz, video bandwidth ≤ 30 Hz.

Drift: <10 Hz/minute of SWEETIME after 1 hr. warmup at stabilized temperature, for frequency span ≤ 100 kHz. Spans >100 kHz but ≤ 1 MHz, <100 Hz/minute of SWEETIME; >1 MHz, <300 kHz/minute of SWEETIME.

Spectral Purity

Noise sidebands: >80 dB below the peak of a CW signal at frequency offsets $\geq 30 \times$ resolution bandwidth setting, for resolution bandwidths ≤ 1 kHz.

Line related sidebands: >85 dB below the peak of a CW signal.

Amplitude

Measurement range: -135 dBm to +30 dBm.

Displayed Range

Scale: over a 10 division CRT vertical axis with the Reference Level at the top graticule line.

Calibration

Log: 10 dB/div for 90 dB display from Reference Level.
5 dB/div for 50 dB display
2 dB/div for 20 dB display expanded from
1 dB/div for 10 dB display reference level

Linear

10% of Reference Level/div when calibrated in voltage.

Fidelity

Log: (over 0 to 90 dB display)

Incremental accuracy: ± 0.1 dB/dB

Maximum cumulative error: (from the reference level)

$\leq \pm 1.0$ dB; ≥ 30 Hz resolution bandwidth

$\leq \pm 2.1$ dB; 10 Hz resolution bandwidth

Linear: $\pm 3\%$ of Reference Level.

Reference Level

Range

Log

+60.0¹ to -139.9 dBm or equivalent in dBmV, dB μ V, volts.

Linear

228.6¹ volts to 0.22 μ volts full scale.

Accuracy: the sum of the following factors determines the accuracy of the reference level readout. Depending upon the measurement technique followed after calibration, various of these sources of uncertainty may not be applicable.

An internal error correction function calibrates and reduces the uncertainty introduced by analyzer control changes from the error calibration state (-7 dBm reference level, 1 dB/div scale, 10 dB RF attenuation, 1 MHz bandwidth) when SHIFT W is executed just prior to the signal measurement (i.e., at the same temperature) within the 20°-30° range.

Calibrator uncertainty: ± 0.2 dB.

Frequency response (flatness) uncertainty²: input #1: ± 1 dB, 100 Hz to 500 MHz; ± 1.5 dB 100 Hz to 1500 MHz; input #2: ± 1 dB, 100 kHz to 1500 MHz.

Amplitude temperature drift: at -10 dBm reference level with 10 dB input attenuation and 1 MHz resolution bandwidth, ± 0.05 dB/°C (eliminated by recalibration).

Input connector switching uncertainty: ± 0.5 dB when calibration and measurement do not use the same RF input.

Input attenuation switching uncertainty: ± 1.0 dB over 10 dB to 70 dB range.

Resolution bandwidth switching uncertainty² (referenced to 1 MHz bandwidth)—corrected (uncorrected)

Resolution BW	20-30°C	0-55°C
	(After 1 Hour Warm-up)	
10 Hz	± 1.1 dB (± 2.0 dB)	(± 4.0 dB)
30 Hz	± 0.4 dB (± 0.8 dB)	(± 2.3 dB)
100 Hz to 1 MHz	± 0.2 dB (± 0.5 dB)	(± 2.0 dB)
3 MHz	± 0.2 dB (± 1.0 dB)	(± 2.0 dB)

Log scale switching uncertainty: ± 0.1 dB corrected (± 0.5 dB uncorrected).

IF Gain uncertainty: corrected (uncorrected). Assuming the internal calibration signal is used to calibrate the reference level at -10 dBm and the input attenuator is fixed at 10 dB, any changes

in reference level in the following ranges will contribute IF gain uncertainty:

Reference Level	20-30°C	0-55°C
0 to -55.9 dBm		
10 Hz Res BW	± 1.0 dB (± 1.6 dB)	(± 2.0 dB)
≥ 30 Hz Res BW	0 dB (± 0.6 dB)	(± 1.0 dB)
-56.0 to -129.9 dBm		
10 Hz Res BW	(± 2.0 dB) ³	(± 2.5 dB)
≥ 30 Hz Res BW	(± 1.0 dB) ³	(± 1.5 dB)

Each 10 dB decrease (or increase) in the amount of input attenuation at the time of calibration and measurement will cause a corresponding 10 dB decrease (or increase) in the absolute reference level settings described above.

RF Gain uncertainty (due to 2nd LO shift): ± 0.1 dB corrected (± 1.0 dB uncorrected)

Error correction accuracy: (applicable when controls are changed from the error calibration state if SHIFT W and SHIFT X are used): ± 0.4 dB.

Marker

Normal: displays the amplitude at the vertical position of the tunable marker.

Accuracy: equals the sum of calibrator uncertainty, reference level uncertainty, and scale fidelity between the reference level and marker position.

PEAK SEARCH positions the marker at the peak of the largest signal present on the display. MKR \rightarrow REF LVL set the analyzer reference level equal to the marker amplitude. RMS noise density in a 1 Hz bandwidth is read out using SHIFT M, by sampling the displayed trace and arithmetically correcting for the analyzer envelope detector response, log shaping, and measurement bandwidth.

Δ : displays the amplitude difference between the stationary and tunable markers. Reference frequency need not be displayed.

Accuracy: equals the sum of scale fidelity and frequency between the two markers.

Reference Lines

Display line: movable horizontal line with amplitude readout.

Threshold: movable horizontal trace threshold with amplitude readout.

Accuracy: equals the sum of calibrator uncertainty, reference level uncertainty, and scale fidelity between the reference level and reference line.

Dynamic Range

Spurious responses: for a total signal power ≤ -40 dBm at the input mixer of the analyzer, all image and out-of-band mixing responses, harmonic and intermodulation distortion products are >75 dB below the total signal power for inputs 10 MHz to 1500 MHz; >70 dB below the total signal power for input signals 100 Hz to 10 MHz.

Video bandwidth: post detection low pass filter used to average displayed noise: bandwidth variable from 1 Hz to 3 MHz in a 1, 3, 10 sequence. All bandwidths are nominal except 3 MHz, which is a minimum. Video bandwidth may be selected manually or coupled to resolution bandwidth.

Displayed noise: bandwidth variable from 1 Hz to 3 MHz in a 1, 3, 10 sequence. Video bandwidth may be selected manually or coupled to resolution bandwidth.

Digital video averaging: displays the sweep-to-sweep average of the trace over a specifiable number of sweeps with SHIFT G, video averaging is turned off with SHIFT H.

Gain compression: <0.5 dB for signal levels ≤ -10 dBm at the input mixer.

Sweep

Trigger

Free run: sweep triggered by internal source.

Line: sweep triggered by power line frequency.

Video: sweep triggered by detected waveform of input signal at an adjustable level; signal must be ≥ 0.5 div peak-to-peak.

External: sweep triggered by rising edge of signal input to rear panel BNC connector; trigger source must be >2.4 volt (5 volt max).

Continuous

Sequential sweeps initiated by the trigger: 20 msec full span to 1500 sec full span in 1, 1.5, 3, 5, 7.5, 10 sequence.

¹Maximum input must not exceed +30 dBm (damage level).

²30 kHz and 100 kHz bandwidth switching uncertainty figures only applicable $\leq 90\%$ relative humidity.

³Correction only applies over the 0 dBm to -55.9 dBm range.

SIGNAL ANALYZERS

Spectrum Analyzer, 100 Hz to 1500 MHz

Model 8568A (cont.)

Accuracy: sweep time ≤ 100 sec, $\pm 10\%$; >100 sec, $\pm 20\%$.

Zero frequency span: 1 μ sec full sweep (10 divisions) to 10 msec full sweep in 1, 2, 5 sequence; 20 msec full sweep to 1500 sec full sweep in 1, 1.5, 2, 3, 5, 7.5, 10 sequence.

Accuracy: same as continuous.

Sweep time may be set manually or automatically for the frequency span, resolution bandwidth and video bandwidth selected.

Single: single sweep armed on activation and initiated by trigger (sweep ≥ 20 msec only).

Display

Trace: A and B are two independent signal response memories each having 1001 horizontal data positions and vertical resolution of 0.1%. Memory contents are displayed on the CRT at a rate independent of the analyzer sweep time. Trace A is displayed brighter than trace B.

Clear/write: clears memory contents when first activated, then writes the analyzer signal response into the memory each sweep and displays memory.

Max hold: retains in memory and displays the largest signal level occurring at each horizontal data position over the repetitive sweeps beginning at the time the function is activated.

View: stops writing into memory and displays memory without changing its contents.

Blank: stops writing into memory and blanks the trace while retaining the last response in memory.

Arithmetic

A-B-A: initially subtracts the stored memory contents of B from the current memory contents of A and writes the difference into A; this process continues as the A memory is updated at the sweep rate. To accomplish A+B-A use SHIFT c.

A \rightleftharpoons B: exchanges A and B display memory contents.

B-DL-B: subtracts the amplitude of the display line from the memory contents of B and writes the difference into B.

A third signal response memory, C (also with a 1001 data positions), can be used for signal response storage. It is accessed indirectly by transferring memory contents between B and C.

B-C: SHIFT l.

B \rightleftharpoons C: SHIFT i.

View C: SHIFT j.

Blank C: SHIFT k.

Annotation

Title: allows the user to write characters into a specified area on the CRT by pushing SHIFT E and typing the keys next to the blue front panel characters and data numbers desired. Use BACKSPACE for corrections.

Blank: SHIFT o blanks (SHIFT p unblanks) all CRT characters and control setting readouts. SHIFT m blanks (SHIFT n unblanks) the CRT graticule.

Input

RF Inputs

The standard instrument configuration is as follows:

Input # 1: 100 Hz to 1500 MHz, 50 Ω , BNC connector (Fused); dc coupled.

Reflection coefficient: typically <0.20 (1.5 SWR) to 500 MHz, <0.33 (2.0 SWR) 500 MHz to 1500 MHz; ≥ 10 dB input attenuation.

Input # 2: 100 kHz to 1500 MHz, 50 Ω , Type N connector; ac coupled.

Reflection coefficient: typically <0.20 (1.5 SWR); ≥ 10 dB input attenuation.

LO emission: typically <-75 dBm (0 dB RF Atten).

Isolation: >90 dB between inputs.

Also available: input #1, 100 kHz to 1500 MHz, 75 Ω , BNC connector, ac coupled (Opt 001).

Maximum Input Level

AC: continuous power, +30 dBm (1 watt); 100 watts, 10 μ sec pulse into ≥ 50 dB attenuation.

DC: Input #1, 0 volts; Input #2, ± 50 volts.

Input attenuator: 70 dB range in 10 dB steps. Zero dB attenuation accessible only through numeric/unit keyboard. Attenuation may be selected manually or coupled to reference level to insure a -10 dBm input mixer drive level for full-screen signals; other mixer levels may be specified using SHIFT, (comma) and entering the desired amplitude through the keyboard.

Accuracy: ± 1.0 dB over 10-70 dB range.

External frequency reference input (rear panel)

Must equal 10 MHz ± 50 Hz, 0 dBm (+10 dBm max.), 50 Ω nominal input impedance. Analyzer phase noise performance may be degraded when an external frequency reference is used.

Quasi-peak (rear panel; nominal values)

Video input: 0-2 Volts. 139 Ω input impedance.

21.4 MHz input: input is nominally -11 dBm (with spectrum analyzer input attenuator set to 10 dB). 50 Ω input impedance.

Output

Calibrator: 20 MHz ± 20 MHz x frequency reference error (1×10^{-9} /Day), -10 dBm ± 0.2 dB; 50 Ω .

Probe power: +15 V, -12.6 V; 150 mA max.

Auxiliary (rear panel; nominal values)

Display: X, Y and Z outputs for auxiliary CRT displays. X, Y: 1 volt full deflection; Z: 0 to 1 V intensity modulation, -1 V blank. BLANK output (TTL level >2.4 V for blanking) compatible with most oscilloscopes.

Recorder

Horizontal sweep output (x axis): a voltage proportional to the horizontal sweep; 0 V for left edge to +10 V for right edge.

Video output (y axis): detected video output proportional to vertical deflection of CRT trace. Output increases 100 mV/div from 0 to 1 V. Output impedance $\leq 475\Omega$.

Penlift output (z axis): 15 V blanking output during retrace.

21.4 MHz IF: a 50 Ω , 21.4 MHz output related to RF input to the analyzer. Output nominally -20 dBm for a signal at the reference level. Bandwidth controlled by the analyzer's resolution bandwidth setting.

1st LO: 2-3.7 GHz, $>+4$ dBm; 50 Ω output impedance.

Frequency reference: 10.000 MHz, 0 dBm; 50 Ω output impedance.

Quasi-peak (rear panel; nominal values)

Video output: 0-2 volts. Output impedance $<10\Omega$.

21.4 MHz output: output is nominally -11 dBm (with spectrum analyzer input attenuator set to 10 dB). 50 Ω output impedance.

Instrument State Storage

Up to 6 complete sets of user-defined control settings may be stored and recalled by pressing SAVE or RECALL and the desired register number (1 to 6) from the keyboard. Instrument state information is retained in memory approximately 30 days in STANDBY mode or after line power is removed.

Remote Operation

The standard 8568A operates on the Hewlett-Packard Interface Bus (HP-IB). All analyzer control settings (with the exception of VIDEO TRIGGER LEVEL, FOCUS, ALIGN, INTENSITY, FREQ ZERO and AMPLD CAL) are remotely programmable. Function values, marker frequency/amplitude, and A/B traces may be output; CRT labels and graphics may be input. An HP-IB cable (not supplied) is required for remote operation.

General

Environmental

Temperature: operating 0°C to 55°C, storage -40 °C to +75°C.

Humidity: operating $<95\%$ R.H., 0°C to 40°C except as noted.

EMI: 8568A conducted and radiated interference is within the requirements of CE03 and RE02 of MIL STD 461A, VDE 0871, and CISPR pub'n 11.

Power requirements: 50 to 60 Hz; 100, 120, 220 or 240 volts (+5%, -10%); approximately 450 VA (40 VA in standby). 400 Hz operation is available as Opt 400.

Weight: total net, 45 kg (100 lb); Display/1F Section, 21 kg (46 lb); RF Section, 24 kg (54 lb). Shipping net, 72 kg (158 lb); Display/1F Section, 27 kg (60 lb); RF Section, 32 kg (70 lb); Manuals and Accessories, 13 kg (28 lb).

Size: 267 H x 425.5 W x 558.8 mm D (10.5" x 16.75" x 22").

Ordering Information

8568A Spectrum Analyzer

Opt 001: 75 Ω (BNC), 100 kHz to 1500 MHz RF Input #1

Opt 010: Rack Slide Kit

Opt 400: 400 Hz Power Line Frequency Operation

Opt 908: Rack Flange Kit

Opt 910: Extra Manual

Opt 913: Rack Flange Kit to Mount Instruments With Handles

8568A + 24D Spectrum Analyzer Operation Course



SIGNAL ANALYZERS

Spectrum Analyzer, 100 Hz to 300 GHz

Model 8566A



- 100 Hz to 22 GHz, external mixing to 300 GHz
- Synthesizer frequency accuracy
- 10 Hz frequency resolution

- Tunable marker with amplitude and frequency readout
- Integrated preselector with automatic peaking feature
- Store and recall of instrument settings

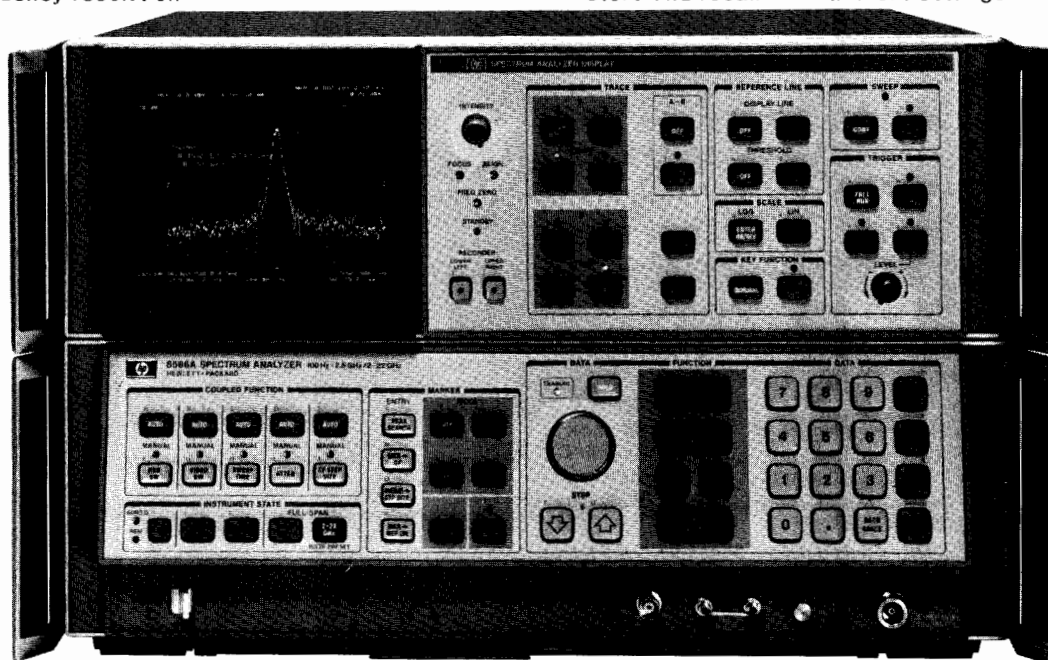

The 8566A Spectrum Analyzer is a high performance spectrum analyzer for bench and remote operation which operates from 100 Hz to 22 GHz using internal mixing. The frequency range may be extended to 60 GHz with the Option E70 External Mixer set (see page 513 for specifications of the 11970 series external mixers) and to 300 GHz with commercially available mixers. (For more information on external mixing, see Product Note 8566A-1 or contact your local HP field engineer). A synthesized local oscillator yields counter-like accuracy at microwave and millimeter wave frequencies. 10 Hz resolution bandwidth and superior frequency stability allow difficult measurements such as line-related sideband characterization at 22 GHz.

A unique integrated preselector/mixer provides high sensitivity with preselection from 2 GHz to 22 GHz. For example, in a 10 Hz resolution bandwidth, the sensitivity at 18 GHz is < -119 dBm.

8566A Specifications

Frequency

Measurement range: 100 Hz to 22 GHz with internal mixer, dc coupled input; 18.6 GHz to 60 GHz with the Option E70 External Mixer Set; 60 GHz to 300 GHz with commercially available external mixers.

Displayed Values

Center frequency: 0 Hz to 300 GHz.

Readout accuracy: (AUTO resolution bandwidth after adjusting frequency zero at stabilized temperature, and using the error correction function, SHIFT W and SHIFT X) spans $\leq n \times 5$ MHz: $\pm(2\%$ of frequency span + frequency reference error \times center frequency + 10 Hz); spans $> n \times 5$ MHz: $\pm(2\%$ of frequency span + $n \times 100$ kHz + frequency reference error \times center frequency) where n is the harmonic number, depending on center frequency:

n	Center Frequency (internal mixing)	n	Center Frequency (external mixing)
1	0 Hz to 5.8 GHz	6	18.6 GHz to 26.5 GHz
2	5.8 GHz to 12.5 GHz	8	26.5 GHz to 40.0 GHz
3	12.5 GHz to 18.6 GHz	10	40.0 GHz to 60.0 GHz
4	18.6 GHz to 22 GHz		

For center frequencies >60.0 GHz, refer to the Frequency Diagnostic (KSR) display for the value of n .

Frequency span: 0 Hz to 22 GHz over 10 division CRT horizontal axis; variable in approximately 1% increments.

Full span: 0 to 2.5 GHz and 2 to 22 GHz. 2 to 22 GHz is selected with INSTR PRESET.

Readout accuracy: spans $\leq n \times 5$ MHz, $\pm 1\%$ of indicated frequency separation; spans $> n \times 5$ MHz, $\pm 3\%$ of indicated frequency separation.

Start/stop frequency: SHIFT O sets the analyzer start and stop frequencies equal to the frequencies of the two Δ markers.

Readout accuracy: same as center frequency.

Frequency reference error: $< 1 \times 10^{-7}$ /day and $< 2 \times 10^{-7}$ /year.

Resolution

Resolution bandwidth: 3 dB bandwidths of 10 Hz to 3 MHz in a 1, 3, 10 sequence. Bandwidth may be selected manually or coupled to frequency span.

Bandwidth accuracy: calibrated to: $\pm 20\%$, 3 MHz to 10 Hz; $\pm 10\%$, 1 MHz to 3 kHz.

Bandwidth selectivity: 60 dB/3 dB bandwidth ratio: $< 15:1$, 3 MHz to 100 kHz; $< 13:1$, 30 kHz to 10 kHz; $< 11:1$, 3 kHz to 30 Hz. 60 dB points on 10 Hz bandwidth are separated by < 100 Hz.

Stability

Residual FM (typical): for fundamental mixing ($n = 1$); < 50 kHz peak-to-peak, frequency span ≥ 5 MHz; < 200 Hz peak-to-peak, frequency span ≤ 5 MHz; < 5 Hz peak-to-peak, frequency span < 100 kHz; < 0.2 Hz peak-to-peak, frequency span < 5 kHz.

Drift (typical): after 1 hour warm-up at stabilized temperature. COUPLED FUNCTION not required.

Frequency Span	Center Frequency Drift
< 100 kHz	< 10 Hz/minute of sweep time
100 kHz to 5 MHz	< 500 Hz/minute of sweep time
≥ 5 MHz	< 5 kHz/minute of sweep time

Because the analyzer is phase locked at the beginning of each sweep, drift occurs only during the time of one sweep.

Spectral Purity

Noise sidebands: > 85 dB below the peak of a 5.8 GHz CW signal at 1 kHz offset; > 79 dB for 12.5 GHz signal; > 75 dB for 18.6 GHz signal; > 73 dB for 22 GHz signal; all for resolution bandwidth ≤ 100 Hz.

Power line related sidebands: > 80 dB below the peak of a 5.8 GHz CW signal, < 360 Hz offset.

Amplitude

Measurement range: -134 dBm to $+30$ dBm.

Display Range

Scale: over a 10 division CRT vertical axis with the Reference Level at the top graticule line.

SIGNAL ANALYZERS

Spectrum Analyzer, 100 Hz to 300 GHz

Model 8566A (cont.)

Calibration

Log: 10 dB/div for 90 dB display from Reference Level.
 5 dB/div for 50 dB display
 2 dB/div for 20 dB display
 1 dB/div for 10 dB display

expanded from
Reference Level

Linear: 10% of Reference Level/div when calibrated in voltage.

Fidelity

Log	Incremental	Cumulative
	±0.1 dB/dB over 0 to 80 dB display	< ±1.0 dB max over 0 to 80 dB display, 20–30°C. < ±1.5 dB max over 0 to 90 dB display.

Linear: ±3% of Reference Level

Reference Level

Range

Log: +30.0 to -99.9 dBm or equivalent in dBmV, dBμV, Volts
 Readout expandable to +60.0¹ volts to -119.9 dBm (-139.9
 dBm for <1 kHz resolution bandwidth) using SHIFT I.

Linear: 7.07 volts to 2.2 μvolts full scale. Readout expandable to
 223.6¹ volts to 2.2 μvolts (0.22 μvolts for <1 kHz resolution
 bandwidth) using SHIFT I.

Accuracy: the sum of the following factors determines the accuracy of the reference level readout. Depending upon the measurement technique followed after calibration with the CAL signal, various of these sources of uncertainty may not be applicable. Specifications are with the preselector tracking optimized with MARKER PRE-SELECTOR PEAK function.

An internal error correction function calibrates and reduces the uncertainty introduced by analyzer control changes from the error calibration state (-7 dBm reference level, and 100 MHz center frequency) when SHIFT W and SHIFT X are executed just prior to the signal measurement (i.e. at the same temperature) within 20–30°C. range.

Calibration uncertainty: ±0.3 dB.

Frequency response (flatness) uncertainty: ±0.6 dB, 100 Hz to 2.5 GHz; ±1.7 dB, 2.0 GHz to 12.5 GHz; ±2.2 dB, 12.5 GHz to 20 GHz; ±3.0 dB, 20 GHz to 22 GHz; for 10 dB attenuator setting. Cumulative flatness ±2.2 dB, 100 Hz to 20 GHz. COUPLED FUNCTION not required as long as display remains calibrated.

Absolute amplitude calibration uncertainty: ±0.6 dB. The certainty of setting the frequency response curve absolutely when using the internal CAL signal or any other calibration signal in the 100 Hz to 2.5 GHz band.

Amplitude temperature drift: at -10 dBm reference level with 10 dB input attenuation and 1 MHz resolution bandwidth. ±0.03 dB/°C (eliminated after recalibration).

Scale Fidelity

Log	Incremental	Cumulative
	±0.1 dB/dB	over 0 to 90 dB display ±1.0 dB ≥ 30 Hz Resolution BW ±2.1 dB 10 Hz Resolution BW

Linear: ±3% of reference level

Resolution bandwidth switching uncertainty²: referenced to 1 MHz bandwidth, corrected (uncorrected).

Resolution BW	Uncertainty
10 Hz	±1.1 dB (±2.0 dB)
30 Hz	±0.4 dB (±0.8 dB)
100 Hz to 1 MHz	±0.2 dB (±0.2 dB)
3 MHz	±0.2 dB (±0.2 dB)

Log scale switching uncertainty: corrected (uncorrected). ±0.1 dB (±0.5 dB).

IF gain uncertainty: corrected (uncorrected). Assuming the internal calibration signal is used to calibrate the reference level at -10 dBm and the input attenuator is fixed at 10 dB, any changes to the reference level function value from -10 dBm will contribute IF gain uncertainty.

Range	Uncertainty
0 to -55.0 dBm	
10 Hz Resolution BW	±1.0 dB (±1.6 dB)
≥30 Hz Resolution BW	0 dB (±0.6 dB)
-56.0 to -129.9 dBm ³	
10 Hz Resolution BW	±2.0 dB (±2.0 dB)
≥30 Hz Resolution BW	±1.0 dB (±1.0 dB)

¹Maximum input must not exceed +30 dBm (damage level).

²Accounted for under Error Correction Accuracy.

The range values change with different input attenuator settings. Each 10 dB decrease (or increase) in the amount of input attenuation at the time of calibration and measurement will cause a corresponding 10 dB decrease (increase) in absolute reference level settings described above.

RF gain uncertainty: corrected (uncorrected) 0 dB (±0.2 dB). The gain change between preselected and non-preselected bands.

Error correction: ±0.4 dB

When the error correction function is used (SHIFT W and SHIFT X), amplitude uncertainty is introduced because additional IF gain is used to offset errors in the switching of resolution BW, amplitude scales and RF gain.

Dynamic Range

Spurious responses: (signals generated by the analyzer due to input signals). For signals <-40 dBm all harmonic and intermodulation distortion >70 dB below input signal.

Second order harmonic distortion: for mixer levels ≤-40 dBm: <-70 dBc, 100 Hz to 50 MHz; <-80 dBc, 50 MHz to 700 MHz; <-70 dBc, 700 MHz to 2.5 GHz. For mixer levels ≤-10 dBm: <-100 dBc, 2 to 22 GHz.

Third order intermodulation distortion: third order intercept (TOI): >+5 dBm, 100 Hz to 5 MHz; >+7 dBm, 5 MHz to 5.8 GHz; >+5 dBm, 5.8 to 18.6 GHz; >+5 dBm (typical), 18.6 GHz to 22 GHz; >+50 dBm (typical), 2 to 22 GHz for >100 MHz signal separation.

Image responses: (due to input signals 642.8 MHz above or below the tuned frequency) <-70 dBc, 100 Hz to 18.6 GHz; <-60 dBc, 18.6 GHz to 22 GHz.

Multiple responses: (due to the input signal mixing with more than one L.O. harmonic) <-70 dBc, 100 Hz to 22 GHz.

Out-of-band responses: (due to input signals outside the preselector's frequency span) <-60 dBc, 2 to 22 GHz.

Synthesis related spurious sidebands: <-90 dBc.

Residual responses: (signals displayed by the analyzer independent of input signals) With 0 dB input attenuation and no input signal: <-100 dBm, 100 Hz to 5.8 GHz; <-95 dBm, 5.8 GHz to 12.5 GHz; <-85 dBm, 12.5 GHz to 18.6 GHz; <-80 dBm, 18.6 GHz to 22 GHz.

Gain compression: <1.0 dB, 100 Hz to 22 GHz with ≤-5 dBm at input mixer.

Average noise level: with 0 dB input attenuation and 10 Hz resolution bandwidth. <-95 dBm, 100 Hz to 50 kHz; <-112 dBm, 50 kHz to 1.0 MHz; <-134 dBm, 1.0 MHz to 2.5 GHz; <-132 dBm, 2.0 GHz to 5.8 GHz; <-125 dBm, 5.8 GHz to 12.5 GHz; <-119 dBm, 12.5 GHz to 18.6 GHz; <-114 dBm, 18.6 GHz to 22 GHz.

Video bandwidth: post detection low pass filter used to average displayed noise bandwidth variable from 1 Hz to 3 MHz in a 1,3,10 sequence. Video bandwidth may be selected manually or coupled to resolution bandwidth.

Digital video averaging: displays the sweep-to-sweep average of the trace over a specifiable number of sweeps with SHIFT G, video averaging is turned off with SHIFT H.

Reference Lines

Display line: movable horizontal line with amplitude readout.

Threshold: movable horizontal trace threshold with amplitude read-out.

Accuracy: equals the sum of calibrator uncertainty, and scale fidelity between the reference level and reference line.

Marker

The marker is a bright dot placed upon the display trace which is positioned horizontally by the DATA controls. The marker amplitude and frequency are read out continuously.

Frequency

Normal: displays the frequency at the horizontal position of the tunable marker. PEAK SEARCH positions the marker at the center of the largest signal response present on the display to within ±10% of resolution bandwidth. Following peak search, SHIFT K moves marker to next higher trace maximum. Subsequent SHIFT K entries move marker to sequentially lower maxima. MKR→CF sets the analyzer center frequency equal to the marker frequency; MKR/Δ→STP SIZE sets the center frequency step size equal to the marker frequency.

Accuracy: same as center frequency accuracy.

³Correction only applies over the 0 dBm to -55.9 dBm range.



Signal track: re-tunes the analyzer to place a signal identified by the marker at the center of the CRT and maintain its position (provided the signal remains on-screen during the period of one sweep). Useful when reducing frequency span to zoom-in on a signal; also keeps a drifting input signal centered.

Δ : displays the frequency difference between the stationary and tunable markers. Reference frequency may be outside current frequency span accuracy. MKR/ Δ →STP SIZE sets the center frequency difference between the markers. SHIFT O sets the analyzer start and stop frequencies equal to the frequencies of the two markers.

Accuracy: same as frequency span accuracy.

Zoom: makes it possible to reduce the frequency span about the marker (or signal in the track mode) using the step down key.

Amplitude

Normal: displays the amplitude at the vertical position of the tunable marker. PEAK SEARCH positions the marker at the peak of the largest signal present on the display.

MKR→REF LVL sets the analyzer reference level equal to the marker amplitude. RMS noise density in a 1 Hz bandwidth is read out using SHIFT M, by sampling the displayed trace and arithmetically correcting for the analyzer detector response, log shaping, and measurement bandwidth.

Accuracy: same as reference level accuracy plus scale fidelity between the reference level and marker position.

Δ : displays the amplitude difference between the stationary and tunable marker. Reference frequency may be outside current frequency span.

Accuracy: same as frequency response uncertainty and scale fidelity between two markers.

Preselector peak: with the marker at the peak of a displayed input signal, preselector peak automatically adjusts preselector tracking for maximum response. SHIFT = resets the preselector tuning to the nominal factory preset condition. If the marker is not activated when preselector peak is used, a peak search will be exercised prior to preselector peaking.

Sweep

Trigger, continuous and single is the same as the 8568A, pages 486 and 485.

Sweptime

Zero Frequency Span

With digital storage: 20 msec full sweep to 1500 sec full sweep n ~ 1% increments.

Without digital storage: 1 μ sec full sweep to 10 msec in 1, 2, 5 sequence.

Marker (sweeps > 20 msec only)

Normal: displays time from beginning of sweep to marker position.

Δ : displays time difference between stationary and tunable marker.

Display

The display functions are the same as the 8568A, page 486.

Input

RF input: 100 Hz to 22 GHz, precision female type N connector, dc coupled.

SWR (typical): 1.2, 100 Hz to 2.5 GHz; 1.5, 2 GHz to 5.8 GHz; 1.9, 5.8 GHz to 22 GHz; with 10 dB input attenuation.

LO emission (typical): < -80 dBm when preselected; < -90 dBm when not preselected.

Maximum Input Level

AC: +30 dBm (1 watt), continuous power, from 50 ohm source. Mixer protected by diode limiter, 100 Hz to 2.5 GHz. < 100 watts, 10 μ sec pulse with \geq 50 dB RF attenuation (\leq 0 dBm peak to input mixer).

DC: < 100 mA current damage level.

Input attenuator: 70 dB steps. Zero dB attenuation accessible only through numeric/unit keyboard. Attenuation may be selected manually or coupled to reference level to insure a -10 dBm input mixer drive level for full-screen signals; other mixer levels may be specified using SHIFT , and entering the desired amplitude through the keyboard.

Accuracy: \pm 1.0 dB over 10-70 dB range.

IF Input

Maximum Input Level

AC: +10 dBm, continuous power, from 50 Ω source.

DC: 20 volts with rise time of < 1 volt/ μ sec.

Sensitivity: -30 dBm at 321.4 MHz produces full-scale CRT deflection \pm 1.0 dB when KSU has been executed.

Quasi-Peak (rear panel; nominal values)

Video input: 0-2 Volts. 139 Ω input impedance.

21.4 MHz input: input is nominally -11 dBm (with spectrum analyzer input attenuator set to 10 dB). 50 Ω input impedance.

Output

Calibrator: 100 MHz \pm (frequency reference error). -10 dBm \pm 0.3 dB, 50 Ω impedance.

Auxiliary

Auxiliary outputs are the same as the 8568A, page 486.

21.4 MHz IF (rear panel): a 50 Ω , 21.4 MHz output related to the RF input to the analyzer. In log scales, the IF output is logarithmically related to the RF input signal; in linear, the output is linearly related. The output is nominally -20 dBm for a signal at the reference level. Bandwidth is controlled by the analyzer's resolution bandwidth setting; amplitude controlled by the input attenuator, and IF step gain positions.

IF Output (front panel)

Maximum Input Level

AC: +10 dBm, continuous power, from 50 Ω source.

DC: 20 volts with rise time of < 1 volt/ μ sec.

1st LO output (front panel): 2.3 to 6.2 GHz, > +8 dBm., 50 Ω output impedance.

Maximum input level: +27 dBm (0.5 watt) total power into 50 Ω impedance.

Frequency reference (rear panel): > -5 dBm, 50 Ω output impedance

Sweep plus tune output (rear panel): 10.000 MHz, 0 dBm; 50 Ω output impedance.

10 MHz output (rear panel): > -5 dBm, 50 Ω output impedance.

Sweep plus tune output (rear panel): -1.0 volt per GHz of tune frequency, > 10 k Ω load.

Accuracy: -1 V/GHz \pm 20% \pm 10 mV.

Quasi-Peak (rear panel; nominal values)

Video output: 0-2 volts. Output impedance > 10 Ω .

21.4 MHz output: output is nominally -11 dBm (with spectrum analyzer input attenuator set to 10 dB). 50 Ω input impedance.

Instrument State Storage

Up to 6 complete sets of user-defined control settings may be stored and recalled by pressing SAVE or RECALL and the desired register number (1 to 6) from the keyboard. Instrument state information is retained in memory indefinitely in STANDBY and approximately 30 days after line power is terminated.

Remote Operation

The standard 8566A operates on the Hewlett-Packard Interface Bus (HP-IB). All analyzer control settings (with the exception of VIDEO TRIGGER LEVEL, FOCUS, ALIGN, INTENSITY, FREQ ZERO and AMPLD CAL) are remotely programmable. Function values, marker frequency/amplitude, and A/B traces may be output; CRT labels and graphics may be input. An HP-IB cable (not supplied) is required for remote operation.

General

Environmental

Temperature: operating 0 $^{\circ}$ C to 55 $^{\circ}$ C, storage -40 $^{\circ}$ C to +75 $^{\circ}$ C.

Humidity: operating < 95% R.H., 0 $^{\circ}$ C to 40 $^{\circ}$ C except as noted.

EMI: conducted and radiated interference is within the requirements of CE03 and RE02 of MIL STD 461A, VDE 0871, and CISPR pub'n 11.

Power requirements: 50 to 60 Hz; 100, 120, 220, or 240 volts (+5%, -10%); approximately 650 VA (40 VA in standby). 400 Hz operation is available as Opt 400.

Weight: total net 50 kg (112 lb); Display/IF Section, 21 kg (47 lb); RF Section, 24 kg (53 lb). Shipping, Display/IF Section 31 kg (69 lb); RF Section 39 kg (87 lb).

Size: 267 H x 425.5 W x 598.5 mm D (10.5" x 16.75" x 23.56").

Ordering Information

8566A Spectrum Analyzer

Opt 010: Rack Slide Kit

Opt 400: 400 Hz Power Line Frequency Operation

Opt 908: Rack Flange Kit

Opt 910: Extra Manual

Opt 913: Rack Flange Kit to Mount Instruments with Handles

Opt E70: 60 GHz External Mixer Set

8566A +24D Spectrum Analyzer Operation Course



SIGNAL ANALYZERS

Automatic Spectrum Analyzers, 100 Hz to 22 GHz

Models 8566S & 8568S

- Choice of BASIC or HPL system software
- Series 200 computer for powerful computer capability
- Assortment of printers and plotters to choose from
- Software to minimize program development time
- Ease of operation via HP-IB



8568S

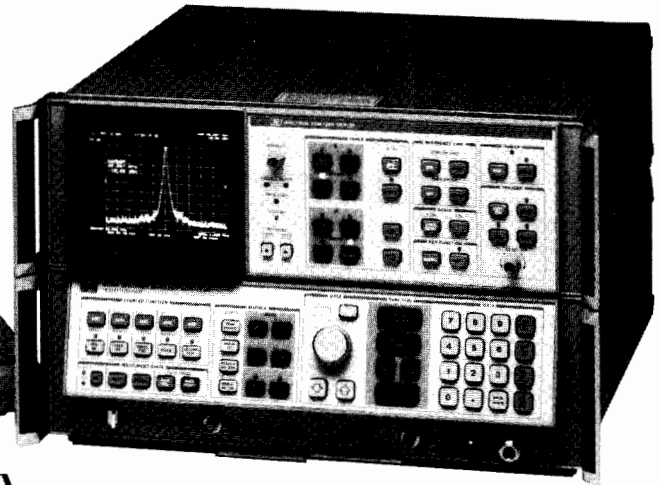

The 8566S and 8568S Automatic Spectrum Analyzers are systems based on the 8566A and 8568A Spectrum Analyzers respectively. The synthesized local oscillators and full programmability of these analyzers make them ideal for automatic systems applications. Each system has an HP Series 200 Desktop Computer, which has the powerful Motorola MC68000 16-bit microprocessor and up to 2 megabytes of main memory. System Software is available in either BASIC or HPL languages. A wide variety of HP-IB printers and plotters are available for this system to provide the user with a great deal of flexibility to tailor the system for his or her needs. Operator training is available through the 8566A +24D or 8568A +24D Spectrum Analyzer Operation Course which provides an intensive 4-day program to provide in-depth knowledge of these two spectrum analyzers. Course size is purposely kept small and hands-on operation is emphasized to facilitate getting the full benefits of the course. The frequency range of the 8566S can be extended above 22 GHz by using external mixers. (See page 513 for more information on the 11970 series mixers.)

System Software

System software is available in both HPL (85862A Software PAC) and BASIC (85863A Software Library) languages for maximum user flexibility. Either package supplies high level software routines (subprograms) to aid the system programmer in developing custom programs for specific applications. In effect, they act as extensions of the spectrum analyzer's built-in firmware, thus enabling a user to write programs on a more conceptual level. For example, many measurements require the maximum amount of dynamic range available

on the spectrum analyzer, given its current settings of center frequency, resolution bandwidth, and the maximum input level expected. Choosing the correct value of input attenuation which will result in the greatest dynamic range normally requires knowledge of the spectrum analyzer's distortion and sensitivity characteristics. Subprogram *OPT-RANGE will automatically compute the optimum value of attenuation and set the spectrum analyzer's attenuator accordingly. Thus, by including *OPT-RANGE as part of the program, a user no longer needs to be concerned with the details of this aspect of the measurement. The 85862A HPL Software Pac also includes a set of Measurement Programs and Utility Programs which make extensive use of the Subprogram Library and illustrate how the subprograms can be utilized. The system software comes on a 5¼ inch flexible disc (3½-inch discs are also available) for use with a series 200 computer. Also included is a manual which provides extensive documentation and line-by-line annotation of each program.

Major System Components

Spectrum Analyzer:	8566A or 8568A
Desktop Computer:	Series 200, Model 16, 26, or 36
Printer:	2671A, 2671G, or 2673A
Plotter:	7470A or 9872C
Software:	85862A (HPL) or 85863A (BASIC)
Operation Training Course:	8566A +24D or 8568A +24D

Ordering Information

8566S Automatic Spectrum Analyzer (8566A based system)

8568S Automatic Spectrum Analyzer (8568A based system)

For complete ordering information, prices, delivery, and available options, contact your local HP field engineer.

SIGNAL ANALYZERS

Quasi-Peak Adapter
Model 85650A

491



- Quasi-peak detection for the 8566A and 8568A
- CISPR specified bandwidths
- Bypass made for regular spectrum analyzer operation

- Fully programmable via HP-IB
- Built-in speaker with volume control
- Auxiliary switches for accessories control

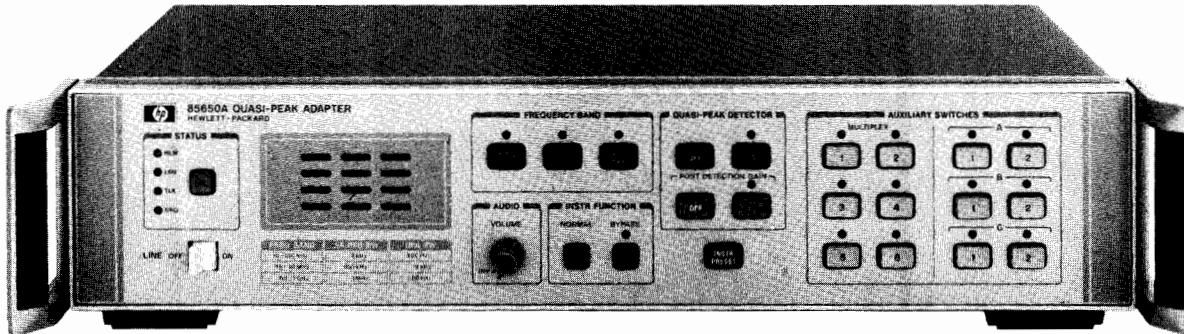

85650A



The 85650A Quasi-Peak Adapter is an accessory to the 8568A and 8566A Spectrum Analyzers. It adds to the spectrum analyzer the resolution bandwidth filters and quasi-peak detection capability specified by Publication 16 of the Comite International Special des Perturbations Radioelectriques (CISPR). Together, the quasi-peak adapter and spectrum analyzer provide many of the elements needed for an EMI receiver system. The 85650A is fully programmable via HP-IB, making automated measurements possible. CISPR bandwidths can be selected using either peak or quasi-peak detection allowing "quick look" peak measurements. A bypass switch is provided to enable the spectrum analyzer to bypass the quasi-peak adapter entirely and operate as a stand-alone instrument.

The pulsed RF signal must not cause gain compression and τ must be less than $1/(3 BW_{qp})$ (BW_{qp} = the 6 dB resolution bandwidth specified by CISPR).

The quasi-peak response to a pulsed RF test signal of peak amplitude V and pulse width τ , will be given by:

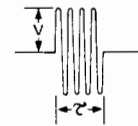

$$\text{Quasi-peak response to test pulse} = \text{Quasi-peak response to CISPR pulse} + 20 \log \frac{V\tau}{(V\tau)_{\text{CISPR}}}$$

85650A Specifications

Fundamental Characteristics

Nominal values for fundamental quasi-peak characteristics are given in the following table:

Frequency Band (MHz)	Bandwidth at 6 dB (kHz)	Charge Time Constant (ms)	Discharge Time Constant (ms)	Display Time Constant (ms)
0.01-0.15	0.2	45	500	160
0.15-30	9	1	160	160
30-1000	120	1	550	100

Filter Selectivity

Response characteristics of the IF filter that determines the overall resolution of the system conform to the limits of overall selectivity given by CISPR Publication 16.

Pulse Response Characteristics¹

In CISPR Publication 16 part 2.1 the CISPR pulse is given by:

- $(V\tau)_{\text{CISPR}} = 0.044 \mu\text{Vs}$ for frequency range of 30-1000 MHz
- $= 0.316 \mu\text{Vs}$ for frequency range of 0.15-30 MHz
- $= 13.5 \mu\text{Vs}$ for frequency range of 10-150 kHz

Pulse Repetition Frequency (Hz)	Quasi-Peak Response To CISPR Pulse (dB μ V)		
	Frequency Band		
	10 to 150 kHz	0.15 to 30 MHz	30 to 1000 MHz
1000	—	64.5 ± 2.5	68.0 ± 2.5
100	64.0 ± 2.5	60.0 ± 1.5	60.0 ± 1.5
60	63.0 ± 2.5	—	—
25	60.0 ± 1.5	—	—
20	—	53.5 ± 2.5	51.0 ± 2.5
10	56.0 ± 2.5	50.0 ± 3.0	46.0 ± 3.0
5	52.5 ± 3.0	—	—
2	47.0 ± 3.5	39.5 ± 3.5	34.0 ± 3.5
1	43.0 ± 3.5	37.5 ± 3.5	31.5 ± 3.5
Isolated Pulse	41.0 ± 3.5	36.5 ± 3.5	28.5 ± 3.5

General

Accessories Furnished

- HP 10833D HP-IB Interconnection Cable 0.5 m (1.6 ft.)
- Four HP 11170A Cable Assemblies, 30 cm (12 in.)
- Front Panel Handles are included as standard.

Compatibility

The HP 85650A is compatible with standard HP 8566A and HP 8568A Spectrum Analyzers having Display Section serial number 2237A04428 and above.

An HP Retrofit Modification Kit Part No. 85650-60050 is available to make prior HP 8566A or HP 8568A Spectrum Analyzers compatible. For HP 8568A Display Sections prefixed 1745A or lower, additional modifications are required as explained in HP Service Note 8568A-40.

Environmental

Temperature: Operating 0°C to 55°C, storage -40°C to +75°C.

EMI

Conducted and radiated interference characteristics are in compliance with methods CE03 and RE02 of MIL-STD 461A, VDE 0871 Level B, and CISPR Publication 11.

Warm-up Time

Requires 10 minute warm-up from cold start, 0°C - 55°C.

Power Requirements

50 to 60 Hz; 100, 120, 220 or 240 volts; 50 to 440 Hz; 100 or 120 volts (+5%, -10%); approximately 22 VA.

Weight

Net 10 kg (22 lb.). Shipping 15.5 kg (34 lb.)

Size

102.6 H x 425.5 W x 558.5 mm D (4.11" x 16.75" x 22").

Ordering Information

85650A Quasi-Peak Adapter

Opt 908: Rack Flange Kit for use with Handles Removed

Opt 910: Extra Manual

Opt 913: Rack Flange Kit for use with Handles Installed

¹This specification was derived by combining CISPR Publication 16 parts 2.1, "Amplitude relationship," and 2.2, "Variation with repetition frequency."

SIGNAL ANALYZERS

Microwave Spectrum Analyzer, 10 MHz to 115 GHz

Model 8569B

- 10 MHz to 22 GHz, external mixing to 115 GHz & above
- Simplified three knob operation
- Internal preselection, 1.7 to 22 GHz
- Wide resolution range, 100 Hz to 3 MHz
- Digital display of traces, control settings
- Unique HP-IB display interface

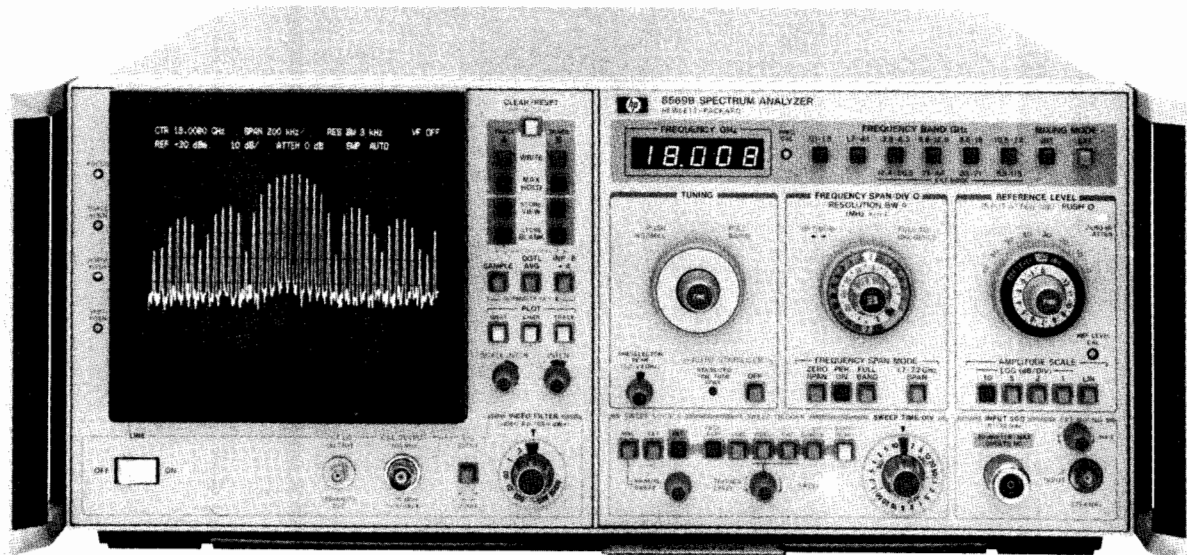

8569B



8569B Spectrum Analyzer

High performance and simple operation are combined with unique new microprocessor-controlled capabilities in the 8569B Microwave Spectrum Analyzer. Excellent sensitivity and internal preselection assure the wide, spurious-free measurement range necessary for production applications, while the digital display and coupled controls speed measurement routines. The internal frequency range of 10 MHz to 22 GHz is extended to 60 GHz using external mixers with the 8569B Option E71 and to 115 GHz and above with other commercially available mixers. For more information on external harmonic mixers see page 513. For semi-automatic operation, connect a desktop computer to the 8569B via HP-IB to allow access to the displayed trace data and the control settings necessary to analyze or record measurements, or display operator messages and prompts on the CRT. Direct, hard copy output to a digital plotter is possible without the need of a controller or programming.

Wide Range of Signal Resolution

Optimum resolution is possible for a wide range of signal characteristics with ten IF filters available from 100 Hz to 3 MHz. Fully automatic stabilization in narrow spans reduces residual FM to allow accurate measurements of closely spaced signals using the narrow bandwidths. The wide 1 and 3 MHz resolution bandwidths allow fast sweeps in wide spans and increased dynamic range for pulsed RF applications. All resolution filters are Gaussian-shaped for repeatable measurements, faster non-distortion sweep speeds, and best pulse response.

High Accuracy and Wide Dynamic Range

Absolute signal levels from -123 to $+30$ dBm are easily and accurately measured using IF substitution because the 8569B displays the reference level value directly on the CRT above the graticule. Damage to the mixer is prevented for signal levels of $+30$ dBm with a built-in limiter below 1.8 GHz and a preselector from 1.7 to 22 GHz. The internal preselector also assures maximum use of this wide measurement range by reducing internal distortion products as much as 120 dB. In addition, flat frequency response insures accuracy for relative as well as absolute power measurements.

Convenient Operation with Digital Display

Preset the 8569B to the color-coded, "basic operation," settings and use the coupled controls to make most measurements in three easy

steps: tune to the signal, select a span and raise it to the reference level. While in the AUTO sweeptime position, a calibrated amplitude display is insured. However, the microprocessor also monitors manually-selected sweeptimes and displays a warning if the sweep speed chosen is too fast for calibrated measurements. Signals are displayed on either of two independent digitally stored traces with all major control settings annotated above the graticule area. Display processing capabilities include Max Hold, digital averaging and trace normalization for extended measurement capability.

HP-IB Includes Direct Plotter Control

A hard-copy record of the displayed traces, control settings and graticule can be made on a digital plotter via HP-IB quickly and simply using the 8569B's front-panel pushbuttons without need for a controller. For maximum capability, attach a controller to the 8569B to read the trace data and control settings for a measurement analysis or recording on tape. Also, you can illustrate the test parameters for each measurement with display lines and instruct the operator with messages on the CRT. The controller can verify correct control settings before taking the test data or going on to the next step.

8444A Option 059 Tracking Generator

Characterize the frequency response of devices up to 1500 MHz by using the 8444A Option 059 Tracking Generator with the 8569B. Dynamic range is greater than 90 dB and system response errors can be removed using trace normalization. In addition, increase the analyzer's frequency accuracy to ± 10 kHz using a counter with the tracking generator. To configure a stimulus response system above 1500 MHz see Application Note 150-13.

8569B Specifications

Frequency Specifications

Frequency range: 0.01 to 22 GHz with internal mixer, 18 to 60 GHz with 8569B Opt. E71 external mixers. Extendable to 115 GHz and above with other commercially available mixers. See page 513 for more information on external harmonic mixers.

Tuning Accuracy (digital frequency readout in any span mode)

10 MHz to 115 GHz: ± 5 MHz or 0.2% of center frequency, whichever is greater, $+20\%$ of Frequency Span/Div).



Frequency Spans

1.7 to 22 GHz: multiband span from 1.7 to 22 GHz in one sweep.

Full band: displays spectrum of entire band selected.

Per division: 1 kHz to 500 MHz/div in a 1, 2, 5 sequence.

Span width accuracy: $\pm 5\%$, 500 MHz to 20 kHz/div unstabilized; $\pm 15\%$, 100 kHz to 1 kHz/div, stabilized.

Zero span: analyzer becomes a manually tuned receiver.

Spectral Resolution and Stability

Resolution bandwidths: resolution (3 dB) bandwidths from 100 Hz to 3 MHz in 1, 3, sequence. Bandwidth and span width are independently variable or may be coupled for optimum display when control markers are aligned (\blacktriangleleft).

Resolution bandwidth accuracy: 3 dB points are $\pm 15\%$.

Selectivity: (60 dB/3 dB bandwidth ratio): $<11:1$, 100 Hz to 1 kHz; $<15:1$, 3 kHz to 3 MHz.

Total residual FM: (fundamental mixing 0.01 to 4.1 GHz): <100 Hz p-p in 0.1 sec. First LO automatically stabilized for frequency spans ≤ 100 kHz/div.

Noise sidebands: >75 dB down, ≥ 30 kHz from signal in a 1 kHz Res. Bandwidth and a 10 Hz (0.01) Video Filter.

Amplitude Specifications

Amplitude Range—Internal Mixer

Total power: +30 dBm, +137 dB μ V (1 watt).

Damage levels: (50 ohm nominal source impedance):

dc: 0 V with 0 dB input attenuation (1 amp), ± 7 V with ≥ 10 dB input attenuation (0.14 amp).

Peak pulse power: +50 dBm (<10 μ sec pulse width, 0.01% duty cycle with ≥ 20 dB input attenuation).

Gain compression: <1 dB for -7 dBm signal, 0 dB input atten.

Average noise level: see table below for max. avg. noise level with 1 kHz Res. bandwidth (0 dB Atten. and 3 Hz video filter).

Frequency Band (GHz)	First IF in MHz	Harmonic Mode	Noise Level (dBm)	Frequency Response* (\pm dB max)
0.01–1.8	2050	1–	-113	1.2
1.7–4.1	321.4	1–	-110	1.5
3.8–8.5	321.4	2–	-107	2.5
5.8–12.9	321.4	3–	-100	2.5
8.5–18	321.4	4+	-95	3.0
10.5–22	321.4	5+	-90	4.5
12.4–26.5	321.4	6+	Depends on the external mixer that is used with the 8569B.	See page 513.
21–44	321.4	10+		
33–71	321.4	16+		
53–115	321.4	26+		

*Frequency response includes input attenuator, preselector and mixer frequency response plus mixing mode gain variation (band to band).

Reference Level

Reference level range: +60 dBm (+30 dBm max. input) to -112 dBm in 10 dB steps and continuous 0 to -12 dB calibrated vernier.

Reference level accuracy: auto Sweep setting of Sweep Time/Div control insures a calibrated display within these limits:

Calibrator output: (100 MHz ± 10 kHz): -10 dBm ± 0.3 dB.

Reference level variation: (input atten. at 0 dB, 20° to 30°C): -10 to -70 dBm: ± 0.5 dB; -80 to -100 dBm: ± 1.0 dB.

Vernier: (0 to -12 dB continuous); maximum error ± 0.5 dB.

Input attenuator: 0–70 dB in 10 dB steps.

Step size variation: ± 1.0 dB, 0.01 to 18 GHz; ± 1.5 dB, 0.01 to 22 GHz. Maximum cumulative error: ± 2.5 dB.

Frequency response: see table above.

Switching between bandwidths: 3 MHz to 100 Hz, ± 1.0 dB.

Calibrated Display Range

Log: 1, 2, 5, and 10 dB/div over 8 divisions.

Linear: 0.56 μ V to 224 V in 50 ohm.

Display Accuracy

Log: ± 0.1 dB/dB; maximum cumulative error: ± 1.5 dB.

Linear: $< \pm 3\%$ over full 8 division deflection.

Residual responses: (no signal present at input): < -90 dBm.

Signal identifier: available from 10 MHz to 115 GHz.

Signal Input/Output Characteristics

Input SWR: (input impedance 50 ohm nominal)

Input atten. at 0 dB: <1.5 , 0.01–1.8 GHz; <2.0 , 1.7–22 GHz.

Input atten. at ≥ 10 dB: <1.3 , 0.01–1.8 GHz; <2.0 , 1.7–22 GHz.

LO emission from RF input: (1.4 to 5.2 GHz): < -60 dBm, 0.01 to 1.8 GHz; < -80 dBm, 1.7 to 22 GHz.

Input Protection: (for input signals from 0.01 to 22 GHz)

0.01 to 1.8 GHz: internal diode limiter.

1.7 to 22 GHz: preselector protects mixer to +30 dBm.

321.4 MHz IF input: SMA female connector is a port for bias current output (± 5 mA) and IF return from an external mixer.

LO output: 2 to 4.46 GHz with minimum power of +8 dBm.

Sweep Specifications

Sweep Time

Auto: sweep time is automatically controlled by Frequency Span/Div, Resolution Bandwidth and Video Filter controls to maintain an absolute amplitude calibrated display.

Calibrated sweep times: 2 μ sec to 10 sec/div in 1, 2, 5 sequence.

Digital Display

Traces: dual trace, digitally stored display with a resolution of 481 horizontal by 801 vertical points for each trace.

Control readout: major control settings annotated on the CRT include Center or Marker frequency, Frequency Span/Div, Resolution BW, Video Filter, Reference Level, Scale Factor, RF Input Attenuator and Sweep Time/Div.

Signal processing: Max Hold, trace normalization, sample detection mode, digital avg. and dB μ V Reference Level readout.

Internal service routines: front-panel pushbuttons access test patterns to perform maintenance of digital hardware.

HP-IB

Direct plotter control: all displayed information can be transferred to an HP-IB plotter with front-panel pushbuttons.

Controller Interface Functions

Trace data transfer: all trace data values can be transferred to or from an 8569B with a controller.

Control readout: all displayed control settings can be transferred to a controller to check measurement conditions.

Input messages: controller-input instructions or annotation can be displayed within two 63 character lines on the CRT.

Sweep control: sweeps can be initiated and monitored.

Note: HP-IB cables are not supplied with the 8569B.

General Specifications

Temperature range: operating 0° to +55°C, storage -40° to +75°C.

Humidity range: (operating): 95% R.H., 0°C to 40°C.

EMI: conducted and radiated interference is in compliance with MIL-STD 461A Methods CE03 and RE02, CISPR Publication 11 (1975), and Messemphaenger-Postverfuegung 526/527/79 (Kennzeichnung Mit F-Nummer/Funkschutzzeichen).

Power requirements: 48–66 Hz, 100, 120, 220 or 240 volts (-10% to +5%), 280 VA max (400 Hz operation available as Opt 400).

Size: 188 H x 426 W x 552 mm D (7" x 16.8" x 21.8").

Weight: net 29.2 kg (64 lb). Shipping 41 kg (90 lb).

Standard Options Available

Opt 001, Internal Comb Generator: 100 MHz comb signals visible through 22 GHz for increased frequency accuracy (error $<0.007\%$, typically ± 1 MHz at 22 GHz) and preselector peaking verification.

Opt 002, Delete 100, 300 Hz Bandwidths: standard specifications apply except minimum resolution bandwidth is 1 kHz with 15:1 shape factor, residual FM <200 Hz when stabilized.

Opt 400, 50 to 400 Hz Power Supply

Part No. 1450–0654—Transit Case: Order Part No. 1490–0913 also for castors.

Ordering Information

8569B Spectrum Analyzer

Opt 001: Internal Comb Generator

Opt 002: Delete 100, 300 Hz Bandwidths

Opt 400: Internal 50 to 400 Hz Power Supply

Opt 908: Rack Flange Kit Without Handles

Opt 910: Extra Operating & Service Manual

Opt 913: Rack Flange Kit with Handles

Opt E71: 18 to 60 GHz External Mixer Set

8444A Opt 059 Tracking Generator

SIGNAL ANALYZERS

Spectrum Analyzer, 10 MHz to 40 GHz

Model 8565A

- 0.01 to 22 GHz, external mixing to 40 GHz
- Internal preselection 1.7 to 22 GHz
- Wide choice of resolution bandwidths
- Simple three knob operation
- Absolute amplitude calibration
- CRT bezel readout displays control settings

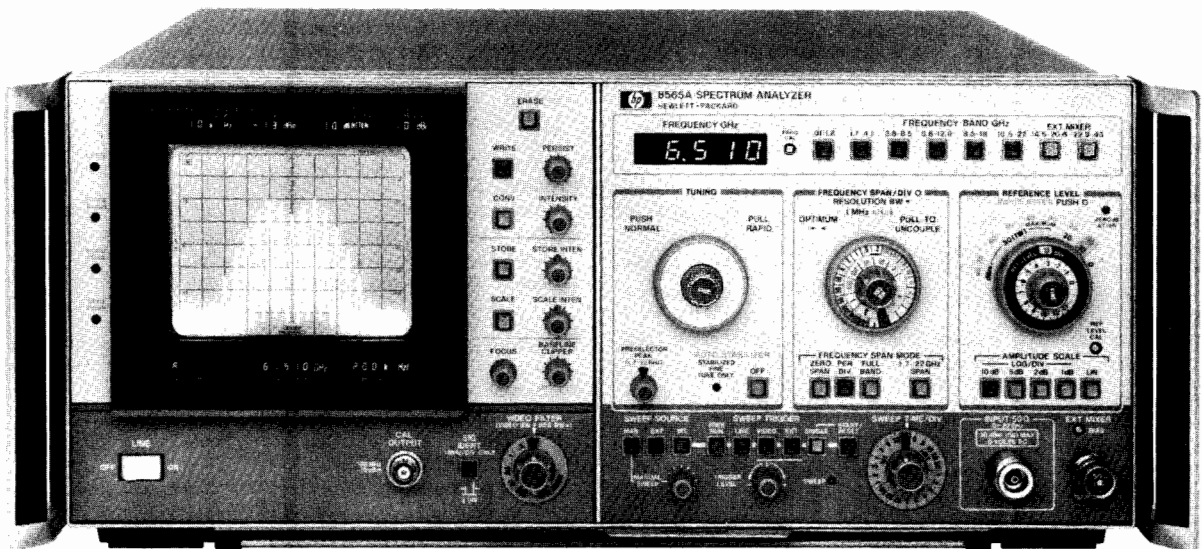

8565A

8565A Spectrum Analyzer

Covering from 0.01 to 22 GHz with its internal mixer, the 8565A has built-in preselection and brings accuracy plus convenience to microwave spectrum analysis. The wide range, spurious-free display, compact design and ease of use make it well suited for lab, production, or field applications requiring accurate measurement from 1F thru microwave frequencies. The 8565A can cover 0.01 to 22 GHz in just two spans for rapid location of signals prior to close-in analysis in one of six bands. Coverage is easily extended up to 40 GHz with the HP 11517A External Mixer.

High Resolution

Fully automatic stabilization in narrow spans reduces residual FM and drift. Standard resolution bandwidths range from 1 kHz to 3 MHz. The 1 and 3 MHz bandwidths allow fast sweeps in wide spans and increased dynamic range for pulsed RF; the narrow bandwidths allow measurement of closely spaced signals. Option 100 provides additional 100 Hz and 300 Hz IF bandwidth filters, and residual FM is <100 Hz when stabilized. This 100 Hz resolution is usable up to 8.5 GHz and the 300 Hz resolution bandwidth to 22 GHz. All resolution filters are gaussian-shaped for repeatable measurements, faster non-distorting sweeps and best pulse response.

Absolute Amplitude Calibration

Absolute signal levels from -112 dBm to +30 dBm are easily measured because the HP 8565A always displays the value of the reference line with LED's in the CRT bezel and at the reference level control. Changes in RF, IF gain, and preselector loss are automatically included. In addition, flat frequency response insures accuracy for relative as well as absolute power measurements.

Wide Dynamic Range

Internal preselection (1.7 to 22 GHz) enables you to measure distortion products as much as 100 dB down. Even for closely spaced signals or measurements below 1.7 GHz, all distortion products are greater than 70 dB down. In either case, maximum dynamic range is assured even for 1 watt signals with the 70 dB input attenuator. An input limiter (0.01 to 1.8 GHz) and the internal preselector (1.7 to 22 GHz) enable the 8565A to withstand RF signals up to +30 dBm for all input attenuator settings.

Designed for Convenience

Coupled controls allow you to make most measurements in 3 simple steps. Green color coded keys preset the 8565A for normal operation so a measurement only requires that you tune to a signal, select a desired span, and raise it to the reference level. Automatically selected sweep times insure a calibrated display for all combinations of fre-

quency span, resolution bandwidth and video filtering.

The CRT bezel LED's display all pertinent control settings to give you all the information needed for signal evaluations in one central location. These data are also captured in CRT photos.

8444A Option 059 Tracking Generator

Make swept frequency response measurements to ± 1.7 dB from 10 to 1300 MHz (± 2.7 dB up to 1500 MHz) with greater than 90 dB of dynamic range. The output is absolutely calibrated at 0 dBm and continuously variable to < -10 dBm. The frequency of unknown signals as well as the frequency of any point on the frequency response curve can be measured from the external counter output using the low-cost HP 5300/5305B Counter.

8750A Storage-Normalizer

The analyzer is made even easier to use with the digital storage of the 8750A because there is no need to re-adjust intensity or persistence as the sweep time changes. With the push of a button, a signal can be frozen on the CRT and then compared directly to the current input signal. Traces can also be compared arithmetically (i.e., normalized) to automatically remove frequency response variations. This is especially useful when used with the HP 8444A Opt. 059 Tracking Generator.

8565A Specifications

Frequency Specifications

Frequency range: 0.01 to 22 GHz with internal mixer, 14.5 to 40 GHz with HP 11517A External Mixer. Extendable to 220 GHz with other commercially available mixers and using signal ID as in Application Note 150-14.

Tuning Accuracy (digital frequency readout in any span mode)

Internal mixing: 0.01 to 2.5 GHz $\leq \pm (5 \text{ MHz} + 20\% \text{ of Frequency Span/Div.})$; 2.5 to 22 GHz $\leq \pm (0.2\% \text{ of center frequency} + 20\% \text{ of Frequency Span/Div.})$.

External mixing: 14.5 to 40 GHz $\leq \pm (0.7\% \text{ of center frequency} + 20\% \text{ of Frequency Span/Div.})$.

Frequency Spans

1.7 to 22 GHz: multiband span from 1.7 to 22 GHz in one sweep.

Full band: displays spectrum of entire band selected.

Per division: eighteen calibrated spans from 1 kHz per div. to 500 MHz per div. in a 1, 2, 5 sequence, plus a full band span, "F".

Span width accuracy: the frequency error for any two points on the display for spans from 500 MHz/div to 20 kHz/div (unstabilized) is less than $\pm 5\%$ of the indicated separation; for stabilized spans 100 kHz/div and less, the error is less than $\pm 15\%$.

Zero span: analyzer becomes a manually tuned receiver.



Spectral Resolution and Stability

Resolution bandwidths: resolution (3 dB) bandwidths from 1 kHz to 3 MHz in 1, 3 sequence. Bandwidth and span width are independently variable or may be coupled for optimum display when control markers are aligned (▶◀).

Resolution bandwidth accuracy: 3 dB points: $< \pm 15\%$.

Selectivity (60 dB/3 dB bandwidth ratio): $< 15:1$.

Stability: total residual FM (fundamental mixing 0.01 to 4.1 GHz): stabilized, < 200 Hz p-p in 0.1 s; unstabilized < 10 kHz p-p in 0.1 s.

Stabilization range: first LO automatically stabilized for frequency spans 100 kHz/div or less. First LO residual FM typically 30 Hz p-p when stabilized.

Noise sidebands: > 70 dB down, > 30 kHz from center of CW signal in a 1 kHz Res. Bandwidth and a 10 Hz (0.01) Video Filter.

Amplitude Specifications

Amplitude Range – Internal Mixer

Measurement Range

Total power: +30 dBm (1 watt).

Damage levels: (50 Ω nominal source impedance.)

dc: 0 V with 0 dB input atten, ± 7 V with ≥ 10 dB input atten.

ac: 0 V with 0 dB input atten, 10 V peak with ≥ 10 dB input atten.

RF: (signals above 10 MHz) + 30 dBm for any attenuator setting.

Gain compression: < 1 dB for 0 dBm input level with 0 dB attenuation.

Average noise level: max. avg. noise level with 1 kHz Res. Bandwidth (0 dB atten and 3 Hz video filter) is in the table below:

Frequency Band (GHz)	First IF in MHz	Harmonic Mode	Noise Level (dBm)	Frequency Response* (\pm dB MAX)
0.01-1.8	2050	1-	-112	1.2
1.7-4.1	321.4	1-	-109	1.7
3.8-8.5	321.4	2-	-103	2.5
5.8-12.9	321.4	3-	-94	2.5
8.5-18	321.4	4+	-87	3.5
10.5-22	321.4	5+	-75	4.5

*Frequency response includes input attenuator, preselector and mixer frequency response plus mixing mode gain variation (band to band).

Amplitude Range - HP 11517A External Mixer

Measurement range: saturation (gain compression < 1 dB), -15 dBm. Damage level $> +10$ dBm.

Sensitivity (average noise level in a 10 kHz IF bandwidth): 14.5–18 GHz < -80 dBm, 18–26.5 GHz < -70 dBm, 26.5–40 GHz < -60 dBm. Typical sensitivity is 10 dB better for each band. **> 40 GHz:** for signal analysis above 40 GHz with commercially available mixers see Application Note 150-14.

Reference Level

Reference level range +70 dBm (+30 dBm max. input) to -102 dBm in 10 dB steps and continuous 0 to -12 dB calibrated vernier. **Reference level accuracy:** the Auto Sweep setting of the sweep time/div control insures a calibrated display within these limits:

Calibrator output (100 MHz \pm 10 kHz): -10 dBm ± 0.3 dB.

Reference level variation (input attenuator at 0 dB): 10 dB steps $< \pm 0.5$ dB (0 to -70 dBm); $< \pm 1.0$ dB (0 to -90 dBm).

Vernier (0 to -12 dB) continuous: maximum error < 0.5 dB.

Input attenuator: (at preselector input, 0-70 dB in 10 dB steps).

Step size variation: $< \pm 1.0$ dB, 0.01 to 18 GHz; $< \pm 1.5$ dB, 0.01 to 22 GHz.

Maximum cumulative error over the 0 to 60 dB range: $< \pm 2.4$ dB, 0.01 to 18 GHz, 0 to 60 dB; $< \pm 2.5$ dB, 0.01 to 22 GHz, 0 to 40 dB.

Frequency response: see table above.

Switching between bandwidths: 3 MHz to 1 kHz, ± 1.0 dB

Calibrated Display Range

Log: (expanded from reference level down): 70 dB @ 10 dB/div, 40 dB @ 5 dB/div, 16 dB @ 2 dB/div and 8 dB @ 1 dB/div.

Linear: full scale from 1.8 μ V (-102 dBm in 50 Ω to 707 volts (+70 dBm) in 10 dB steps and continuous 0 to -12 dB vernier.

Display Accuracy

Log: $< \pm 0.1$ dB/dB, but $< \pm 1.5$ dB over full 70 dB display range.

Linear: $< \pm 3\%$ over full 8 division deflection.

Residual responses (no signal present at input): with 0 dB input atten, fundamental mixing (0.01 to 4.1 GHz) < -90 dBm.

Signal identifier: available from 10 MHz to 40 GHz and in all Freq. Span/Div settings for signal identification.

Signal Input Characteristics

Input impedance: 50 ohm nominal, 0.01 to 22 GHz.

Input connector: precision Type N female.

Input SWR

Input attenuator at 0 dB: < 1.5 , 0.01 to 1.8 GHz; < 2.0 , 1.7 to 22 GHz.

Input attenuator at ≥ 10 dB: < 1.3 , 0.01 to 1.8 GHz, < 2.0 , 1.7 to 22 GHz.

LO Emission (2.00 to 4.46 GHz): -50 dBm, 0.01 to 1.8 GHz; -85 dBm, 1.7 to 22 GHz.

Input Protection (for input signals from 0.01 to 22 GHz)

0.01 to 1.8 GHz frequency band: internal diode limiter.

1.7 to 22 GHz frequency bands: saturation of YIG filter (pre-selector) occurs at total input signal power levels below input mixer damage.

External mixer input: BNC female connector is a port for LO power transfer, bias current and IF return.

Sweep Specifications

Sweep Time

Auto: sweep time is automatically controlled by Frequency Span/Div, Resolution Bandwidth and Video Filter controls to maintain an absolute amplitude calibrated display.

Calibrated sweep times: 21 internal sweep times from 2 μ s/div to 10 s/div in 1, 2, 5 sequence.

Display Characteristics

Cathode Ray Tube (aluminized P31 phosphor, 8 \times 10 div internal graticule)

Persistence

Conventional: natural persistence of P31 phosphor.

Write: continuously adjustable from 0.2 s to full storage.

Storage time: continuously adjustable from 1 minute (full brightness) to > 30 minutes (minimum brightness).

Write speed: continuously adjustable to vary CRT sensitivity to capture large signal deflections in fast sweeps.

CRT Bezel readout: bezel LEDs display the following measurement data (included in CRT photographs taken with the HP 197B Opt 001, 006 Oscilloscope Camera): Ampl. Scale Factor, Ref. Level, Input Atten., Res. Bandwidth, Sweeptime/Div., Freq., Freq. Span/Div.

General Specifications

Temperature range: operating 0°C to 55°C, storage -40° to $+75^\circ$ C.

Humidity range (operating): $< 95\%$ R.H. 0°C to 40°C.

EMI: Conducted and radiated interference is in compliance with MIL-STD 461A Methods CE03 and RE02, CISPR publication 11 (1975), and Messemphaenger-Postverfuegung 526/527/79 (Kennzeichnung Mit F-Nummer/Funkschutzzeichen).

Power requirements: 48-66 Hz, 100, 120, 200 or 240 volts (-10% to $+5\%$) 220 VA max (400 Hz operation available as Opt 400).

Size: 188 H x 426 W x 552 mm D (7" x 16.8" x 21.8").

Weight: net 29.5 kg (64 lb). Shipping 39 kg (85 lb).

Standard Options Available

Opt 100, 100 and 300 Hz resolution bandwidths: adds 100 Hz and 300 Hz resolution bandwidths with 11:1 shape factor, residual FM < 100 Hz when stabilized and improves sensitivity by 10 dB.

Opt 200—Calibration in dB μ V

Opt 400—400 Hz Power Supply

Part No. 1540-0654 - Transit Case. Order Part No. 1490-0913 also for castors.

Ordering Information

8565A Spectrum Analyzer

Opt 100: 100 Hz and 300 Hz Resolution

Bandwidths

Opt 200: Calibration in dB μ V

Opt 400: Internal 50 to 400 Hz Power Supply

Opt 908: Rack Flange Kit

Opt 910: Extra Operating and Service Manual

Opt 913: Rack Flange Kit for instruments with handles

11517A External Mixer (taper section req'd)

11518A Taper Section, 12.4 to 18 GHz

11519A Taper Section, 18 to 26.5 GHz

11520A Taper Section, 26.5 to 40 GHz

8444A Opt 059 Tracking Generator, 10 to 1500 MHz

8750A Storage-Normalizer

SIGNAL ANALYZERS

Spectrum Analyzer, 0.01 to 350 MHz

Models 8557A/853A

- Rugged portability
- Simple, three knob operation
- Direct plotter control
- ± 2.25 dB amplitude accuracy
- Resolution bandwidths from 1 kHz to 3 MHz
- Optional 75 Ω input with dBm or dBmV calibration

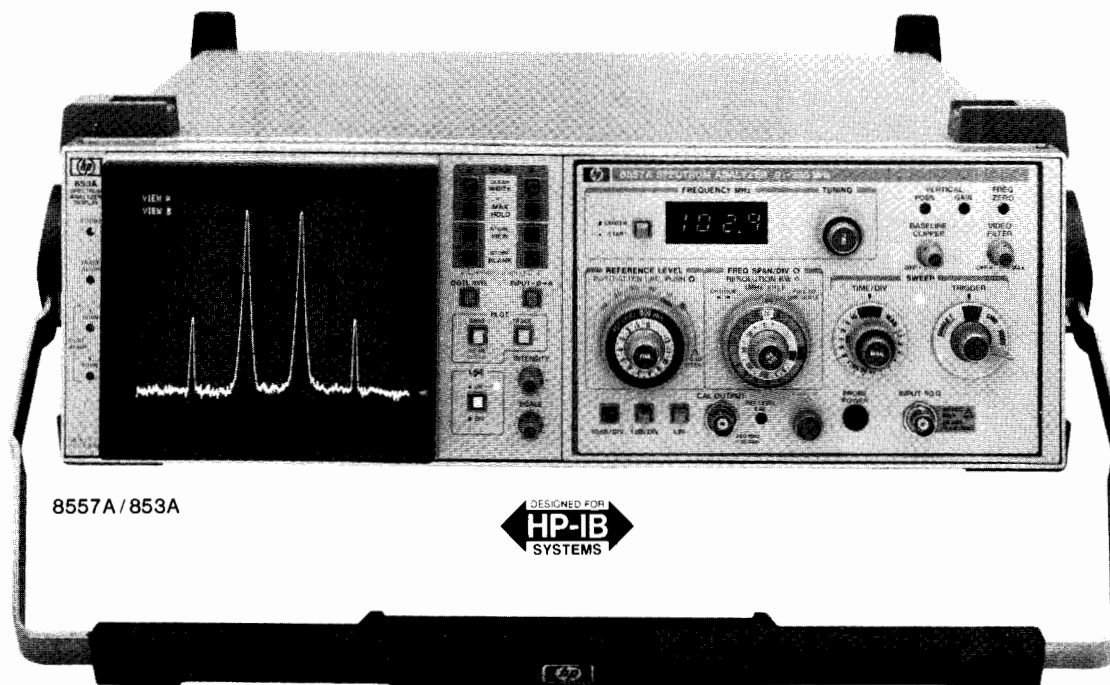

8557A Spectrum Analyzer Plug-In

Performance Plus Economy

The 8557A is a 10 kHz to 350 MHz spectrum analyzer plug-in for use with the 853A or 180-series display. The high performance and convenient operation of this economical unit is ideally suited for a variety of applications in production, R & D or field service measurements.

Simple 3-Knob Operation

Preset the 8557A to the color-coded, "basic-operation" settings, and use the coupled controls to make most measurements in three easy steps. Tune to the signal; the LED readout displays its frequency. Zoom-in on the signal by reducing the span width; the resolution bandwidth, video filter, and sweeptime automatically change to an optimum value for a calibrated display. Then, change the reference level to bring the peak of the signal to the top of the screen for the most accurate amplitude measurement.

Absolute Amplitude Calibration

Signal levels can be read directly from the CRT in dBm (dBmV for Option 002) without the use of external standards or calculations. The signal level represented by the top CRT graticule line is always indicated by the reference level control, and vertical scale factors of 10 dB/div, 1 dB/div or linear can be selected.

Optional 75 Ω Input

Two options are available which allow measurements in 75 Ω systems. Option 001 has 75 Ω impedance, but retains the dBm power calibration. Option 002 is also 75 Ω , but the amplitude is calibrated in dBmV for measurements on systems such as CATV.

853A Spectrum Analyzer Display

Digital Display

The 853A is a digital display mainframe for use with the 8557A spectrum analyzer plug-in. Signals are displayed on either of two independently stored digital traces. Display processing capabilities include maximum hold, digital averaging, and trace normalization for extended measurement capability. A built-in microprocessor

manages the display operation and provides built-in test routines for display calibration and test (accessible via the front panel).

HP-IB Capability Includes Direct Plotter Control

A hard-copy record of the displayed traces and graticule can be made on a digital plotter via HP-IB by simply using the 853A's front-panel pushbuttons; a controller is not required. Although the analyzer controls are not programmable, some HP-IB capabilities include using a controller for recording trace data or for operator prompts on the 853A CRT. The digital display and processing functions can be remotely programmed, and analyzer sweeps can be initiated via HP-IB.

Two Configurations

The display is offered in two styles. The 853A (pictured) is a ruggedized, portable mainframe complete with tilt-bail handle and drip proof, protective front cover. The 853A is ideally suited for rugged, field service environments and any areas where system mobility is required. The 853A Option 001 offers the digital display in a full module bench or rack mount configuration.

8557A Specifications

Frequency Specifications

Frequency range: 0.01 to 350 MHz.

Frequency Spans

Full band: displays entire spectrum, 0.01 to 350 MHz.

Per division: 5 kHz to 20 MHz/div in a 1, 2, 5 sequence.

Zero span: analyzer functions as a manually tuned receiver.

Frequency Accuracy

Tuning accuracy: $\pm (3 \text{ MHz} + 10\% \text{ of frequency span per division})$.

Frequency span accuracy: $\pm 10\%$ of displayed frequency separation.

Spectral Resolution

Resolution bandwidths: eight selectable resolution (3-dB) bandwidths from 1 kHz to 3 MHz in a 1, 3 sequence. Bandwidth and frequency span are independently variable or may be coupled for optimum display when control markers are aligned (▶◀).



Resolution bandwidth accuracy: 3-dB points are $\pm 20\%$ ($+10^\circ$ to $+40^\circ\text{C}$).

Selectivity: (60-dB/3-dB bandwidth ratio) $< 15:1$.

Spectral Stability

Residual FM: < 1 kHz p-p in 0.1 second.

Noise sidebands: ≥ 75 dB down, > 50 kHz from center of CW signal with 1 kHz resolution bandwidth and full video filtering.

Amplitude Specifications

Amplitude range: -117 dBm to $+20$ dBm.

Maximum Input (damage) Levels

Total power: $+20$ dBm (100 mW, 2.24 Vrms).

DC or AC (< 100 Hz): ± 30 V.

Gain compression: typically < 1 dB for -10 dBm signal, 0 dB input attenuation.

Average noise level: < -107 dBm with 10 kHz resolution bandwidth, 0 dB input attenuation, and maximum (MAX) video filtering.

Calibrated Display Range

Log: 70 dB with 10 dB/div scale; 8 dB with 1 dB/div scale.

Linear: 8 divisions with linear (LIN) amplitude scale.

Amplitude Accuracy

Calibrator: -30 dBm ± 1 dB (into 50 Ω), 250 MHz ± 50 kHz.

Reference level: 10 dB steps and a 12 dB vernier for calibrated adjustment from -112 dBm to $+40$ dBm¹.

Step accuracy (with 0 dB input attenuation): -10 to -80 dBm: ± 0.5 dB; -10 to -100 dBm: ± 1.0 dB.

Vernier accuracy: ± 0.5 dB.

Frequency response: $\leq \pm 0.75$ dB with 10 dB input attenuation (includes input attenuator and mixer flatness).

Input attenuator: 0 to 50 dB, selectable in 10 dB steps.

Step accuracy: $< \pm 0.5$ dB per 10 dB step.

Maximum cumulative error: $< \pm 1.0$ dB.

Bandwidth Switching (amplitude variation)

3 MHz to 300 kHz: $< \pm 0.5$ dB.

3 MHz to 1 kHz: $< \pm 1.0$ dB.

Display Fidelity

Log incremental accuracy: ± 0.1 dB/dB from Reference Level.

Log maximum cumulative error: $\leq \pm 1.5$ dB over 70 dB range.

Linear accuracy: $\pm 3\%$ of Reference Level.

Spurious Responses

Second harmonic distortion: > 70 dB below a -40 dBm signal (> 1 MHz) with 0 dB input attenuation; > 60 dB below for signals 20 kHz to 1 MHz.

Third order intermodulation distortion: > 70 dB below two -40 dBm input signals (> 1 MHz) separated by ≥ 50 kHz and with 0 dB input attenuation; > 60 dB below for signals 10 kHz to 1 MHz.

Image and multiple responses: > 70 dB below a -40 dBm input signal (> 1 MHz) with 0 dB input attenuation; > 60 dB below for signals 20 kHz to 1 MHz.

Residual responses: < -100 dBm with 0 dB input attenuation and no signal present at input.

Sweep Characteristics

Sweep Time

Automatic: sweep time is automatically adjusted to maintain absolute amplitude calibration for any combination of frequency span, resolution bandwidth, and video filter bandwidth.

Calibrated sweep times: 0.1 msec to 10 sec/div in 1, 2, 5 sequence with $\pm 10\%$ typical accuracy.

Manual sweep: spectrum analyzer may be swept manually in either direction with front panel control.

Signal Input Characteristics

Input impedance: 50 Ω nominal; type BNC female connector.

Input SWR: typically < 1.5 with ≥ 10 dB input attenuation.

Output Characteristics

Probe power: $+15$ V, -12.6 V, and GND (150 mA max). Use HP 1120A, 1121A, or 1124A high impedance probes.

Vertical output, AUX A: BNC output (50 Ω) provides detected video from 0 to 0.8 V for 8 divisions deflection on CRT display.

Penlift/blinking, AUX B: BNC output provides 0V pen down/unblinking signal at low impedance; 15V penlift/blinking at 10 k Ω impedance.

21.4 MHz IF output, AUX C: BNC output (50 Ω) provides a signal which is proportional to the RF input. Level is about -10 dBm (into 50 Ω) with a signal displayed at the Reference Level. Output is controlled by settings of Resolution BW, Input Atten, and Reference Level.

Horizontal output, AUX D: BNC output (5 k Ω) provides horizontal sweep from -5 V to $+5$ V for full 10 division CRT horizontal deflection.

853A Characteristics

Digital Display

Traces: dual trace, digitally stored display with resolution of 481 horizontal by 801 vertical points for each trace.

Signal processing: maximum hold, digital averaging, and trace normalization.

Internal service routines: front panel pushbuttons access test routines to perform maintenance of digital hardware.

HP-IB

Direct plotter control: all displayed information can be transferred to an HP-IB plotter with front panel pushbuttons.

Controller Interface Functions

Trace data transfer: all trace data values can be transferred to or from 853A with a controller.

Input messages: controller input instructions or annotation can be displayed on either of two 60 character lines.

Display control: all trace processing functions can be remotely controlled.

Sweep control: analyzer sweeps can be initiated and monitored.

General

General Specifications

180-Series compatibility: the HP 8557A Spectrum Analyzer is compatible with the 180T-Series displays as well as the 853A². The 182T is a normal persistence cabinet style display; the 181T offers variable persistence and storage; the 181TR is a rack mount configuration with normal persistence. All 180T-Series displays provide non-buffered, rear panel, auxiliary outputs (for unattenuated vertical, horizontal, and penlift outputs). However, they do not offer the digital display, HP-IB and direct plotter control, nor the portability features of the 853A.

Temperature range: operating 0° to $+55^\circ\text{C}$; storage -40° to $+75^\circ\text{C}$.

EMI: conducted and radiated interference is within requirements of Methods CE03 and RE02 of MIL-STD 461A, CISPR Publication 11 (1975), and Messemppaenger Postverfuegung 526/527/79 (Kennzeichnung Mit F-Nummer/Funkschutzzeichen).

Power: < 200 VA with display, 48 to 440 Hz (48 to 66 Hz at 220 or 240 Vac); with 853A: 100, 120, 220, or 240 Vac, $+5\%$, -10% ; with 180-series: 115 or 230 Vac, $\pm 10\%$.

Weight

Model 8557A: net, 5.0 kg (10 lb). Shipping 8.5 kg (18 lb).

Model 853A: net, 15.9 kg (35 lb). Shipping 18.6 kg (41 lb).

Model 853A Opt 001: net, 14.5 kg (32 lb). Shipping, 17.3 kg (38 lb).

Size

Model 853A/8557A: 158.8 H x 501.7 W x 524.5 mm D (6.25" x 19.75" x 20.65").

Model 853A Opt 001/8557A: 133 H x 425.5 W x 473.3 mm D (5.25" x 16.75" x 18.65").

Ordering Information

8557A Spectrum Analyzer

Opt 001: 75 ohm input, dBm calibration

Opt 002: 75 ohm input, dBmV calibration

Opt 910: Extra Operation and Service Manual

853A Portable Spectrum Analyzer Display

Opt 001: Full Module Bench/Rack Configuration

Opt 910: Extra Operation and Service Manual

182T Cabinet Style, Normal Persistence Display

180TR Rack Mount, Normal Persistence Display

181T Cabinet Style, Variable Persistence Display

181TR Rack Mount 181T Display

¹ Input not to exceed maximum levels.

² A simple modification is required for 8557A plug-ins with serial prefix 2106A and lower (modification kit, HP part number 00853-80057).

SIGNAL ANALYZERS

Spectrum Analyzer, 0.1 to 1500 MHz

Models 8558B/853A & 8444A Option 059

- Rugged portability
- Simple three knob operation
- Direct plotter control

- Resolution bandwidths from 1 kHz to 3 MHz
- 0.5 to 1500 MHz tracking generator available
- Optional 75 Ω input with dBm or dBmV calibration

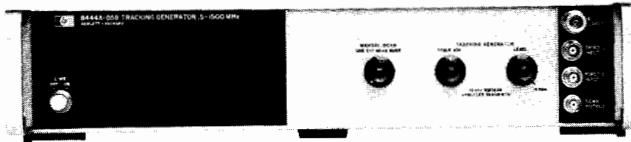
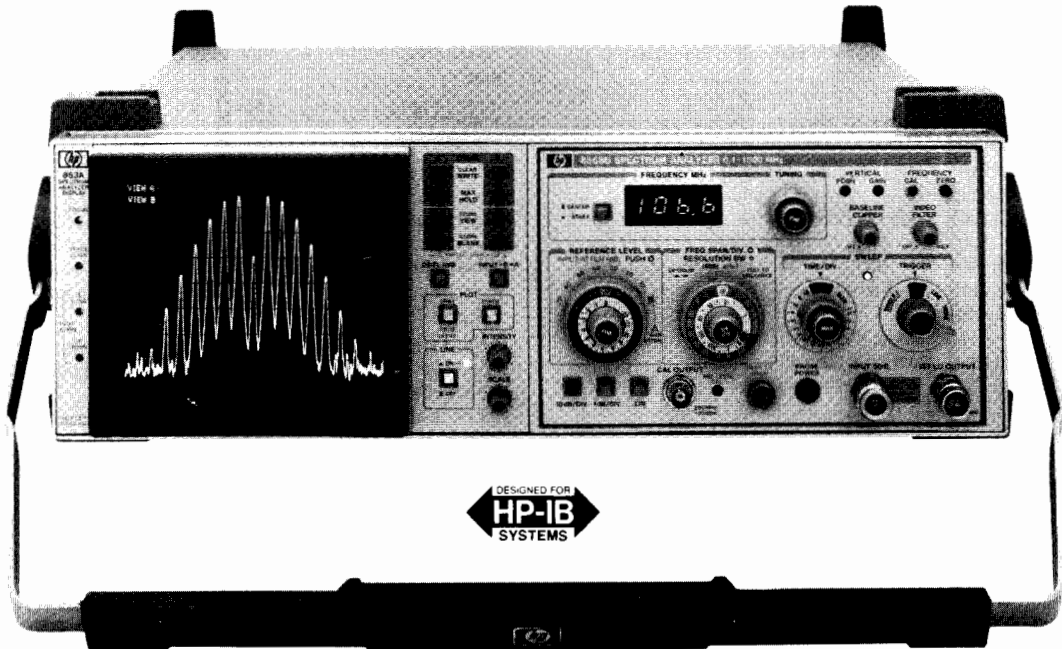

8444A Opt. 059

8558B Spectrum Analyzer Plug-in

Performance Plus Economy

The 8558B is a 100 kHz to 1500 MHz spectrum analyzer plug-in for use with the 853A or 180 series display. The high performance and convenient operation of this economical unit is ideally suited for a variety of applications in production, R&D or field service measurements.

Simple, 3-knob Operation

Preset the 8558B to the color coded, "basic-operation" settings, and use the coupled controls to make most measurements in three easy steps. Tune to the signal; the LED readout displays its frequency. Zoom-in on the signal by reducing the span width; the resolution bandwidth, video filter, and sweep time automatically change to an optimum value for a calibrated display. Then, change the reference level to bring the peak of the signal to the top of the screen for the most accurate amplitude measurement.

Absolute Amplitude Calibration

Signal levels can be read directly from the CRT in dBm (dBmV for Option 002) without the use of external standards or calculations. The signal level represented by the top CRT graticule line is always indicated by the reference level control, and vertical scale factors of 10 dB/div, 1 dB/div, or linear can be selected.

Optional 75 Ohm Input

Two options are available which allow measurements in 75 ohm systems. Option 001 has 75 Ω impedance but retains the dBm power calibration. Option 002 is also 75 Ω , but the amplitude is calibrated in dBmV for measurements on systems such as CATV.

8444A Option 059 Tracking Generator (0.5-1500 MHz)

Make swept frequency response measurements from 0.5 to 1500 MHz with greater than 90 dB of dynamic range. The output is absolutely calibrated at 0 dBm and continuously variable to -10 dBm.

Frequency of an unknown signal, as well as any point on a frequency response curve, can be measured by using the external counter output and a frequency counter such as the Model 5300B/5305B.

853A Spectrum Analyzer Display Digital Display

The 853A is a digital display mainframe for use with the 8558B Spectrum Analyzer plug-in. Signals are displayed on either of two independently stored digital traces. Display processing capabilities include maximum hold, digital averaging, and trace normalization for extended measurement capability. A built-in microprocessor manages the display operation and provides built-in test routines for display calibration and test (accessible via the front panel).

HP-IB Capability Includes Direct Plotter Control

A hardcopy record of the displayed traces and graticules can be made on an HP-IB digital plotter by simply using the 853A's front-panel pushbuttons; a controller is not required. Although analyzer controls are not programmable, some HP-IB applications include using a controller for recording trace data or for placing operator prompts on the 853A CRT. The digital display and processing functions can be remotely programmed, and analyzer sweeps can be initiated via HP-IB.

Two Configurations

The display is offered in two styles. The 853A (pictured) is a ruggedized, portable mainframe complete with tilt-bail handle and drip-proof, protective front cover. The 853A is ideally suited for rugged, field environments and any areas where system mobility is required. The 853A Option 001 offers the digital display in a full module bench or rack mount configuration.

8558B Specifications

Frequency Specifications

Frequency range: 0.1 to 1500 MHz.

Frequency Spans

Per division: 5 kHz to 100 MHz/div in a 1, 2, 5 sequence.

Zero span: analyzer functions as a manually tuned receiver.

Frequency Accuracy

Tuning accuracy: (+10°C to +40°C)

0-195 MHz: $\pm(1 \text{ MHz} + 20\% \text{ frequency span per division})$.

195-1500 MHz: $\pm(5 \text{ MHz} + 20\% \text{ frequency span per division})$.

Frequency span accuracy: $\pm 5\%$ of displayed frequency separation.



Spectral Resolution

Resolution bandwidths: eight selectable resolution (3-dB) bandwidths from 1 kHz to 3 MHz in a 1, 3 sequence. Bandwidth and frequency span are independently variable or may be coupled for optimum display when control markers are aligned (▶◀).

Resolution bandwidth accuracy: 3-dB points are $\pm 20\%$ ($+10^\circ$ to $+40^\circ\text{C}$).

Selectivity: (60-dB/3-dB bandwidth ratio) $< 15:1$.

Spectral Stability

Residual FM: < 1 kHz p-p in 0.1 second.

Noise sidebands: ≥ 65 dB down, ≥ 50 kHz from center of CW signal with 1 kHz resolution bandwidth and full video filtering.

Amplitude Specifications

Amplitude range: -117 to $+30$ dBm.

Maximum Input (damage) Levels

Total power: $+30$ dBm (1W, 7.1 Vrms).

dc or ac (< 100 Hz): ± 50 V.

Peak pulse power: $+50$ dBm (100W, < 10 μs pulse width, 0.01% duty cycle) with ≥ 20 dB input attenuation.

Gain compression: typically < 1 dB for -10 dBm signal, 0 dB input attenuation.

Average noise level: < -107 dBm with 10 kHz resolution bandwidth, 0 dB input attenuation, and maximum (MAX) video filtering.

Calibrated Display Range

Log: 70 dB with 10 dB/div scale; 8 dB with 1 dB/div scale.

Linear: 8 divisions with linear (LIN) amplitude scale.

Amplitude Accuracy

Calibrator: -30 dBm ± 1 dB (into 50 Ω), 280 MHz ± 300 kHz.

Reference level: 10 dB steps and a 12 dB vernier for calibrated adjustment from -112 dBm to $+60$ dBm.¹

Step accuracy (with 0 dB input attenuation): -10 to -80 dBm: ± 0.5 dB; -10 to -100 dBm: ± 1.0 dB.

Vernier accuracy: ± 0.5 dB.

Frequency response: $\leq \pm 1.0$ dB with 10 dB input attenuation (includes input attenuator, mixer flatness, and internal limiter).

Input attenuator: 0 to 70 dB, selectable in 10 dB steps.

Step accuracy: $< \pm 0.5$ dB per 10 dB step.

Maximum cumulative error: $< \pm 1.0$ dB.

Bandwidth Switching (amplitude variation)

3 MHz to 300 kHz: $< \pm 0.5$ dB.

3 MHz to 1 kHz: $< \pm 1.0$ dB.

Display Fidelity

Log incremental accuracy: ± 0.1 dB/dB from Reference Level.

Log maximum cumulative error: $\leq \pm 1.5$ dB over 70 dB range.

Linear accuracy: $\pm 3\%$ of Reference Level.

Spurious Responses

Second harmonic distortion: > 70 dB below a -40 dBm input signal with 0 dB input attenuation; > 60 dB below for signals 100 kHz to 5 MHz.

Third order intermodulation distortion: > 70 dB below two -30 dBm input signals (> 5 MHz) separated by ≥ 50 kHz and with 0 dB input attenuation; > 60 dB below for signals 100 kHz to 5 MHz.

Image and multiple responses: > 70 dB below a -40 dBm input signal (> 5 MHz) with 0 dB input attenuation; > 60 dB below for signals 100 kHz to 5 MHz.

Residual responses: < -100 dBm with 0 dB input attenuation and no signal present at input.

Sweep Characteristics

Sweep Time

Automatic: sweep time is automatically adjusted to maintain absolute amplitude calibration for any combination of frequency span, resolution bandwidth, and video filter bandwidth.

Calibrated sweep times: 0.1 ms to 10 sec/div in 1, 2, 5 sequence with $\pm 10\%$ typical accuracy.

Manual sweep: spectrum analyzer may be swept manually in either direction with front panel control.

Signal Input Characteristics

Input impedance: 50 Ω nominal; precision Type-N female connector.

Input SWR: typically < 1.5 with ≥ 10 dB input attenuation.

Output Characteristics

1st LO output: BNC output provides $+10$ dBm nominal signal (into 50 Ω), 2.05 to 3.55 GHz.

Probe power: $+15$ V, -12.6 V, and GND (150 mA max). Use HP 1120A, 1121A, 1123A, or 1124A high impedance probes.

Vertical output, AUX A: BNC output (50 Ω) provides detected video from 0 to 0.8 V for 8 division deflection on CRT display.

Penlift/blanking, AUX B: BNC output provides 0 V pen down/unblanking signal at low impedance; 15 V penlift/blanking at 10 k Ω impedance.

21.4 MHz IF output, AUX C: BNC output (50 Ω) provides a signal which is proportional to the RF input. Level is about -10 dBm (into 50 Ω) with a signal displayed at the Reference Level. Output is controlled by settings of Resolution BW, Input Atten, and Reference Level.

Horizontal output, AUX D: BNC output (5 k Ω) provides horizontal sweep from -5 V to $+5$ V for full 10 division CRT horizontal deflection.

853A Characteristics

Digital Display

Traces: dual trace, digitally stored display with resolution of 481 horizontal by 801 vertical points for each trace.

Signal processing: maximum hold, digital averaging, and trace normalization.

Internal service routines: front panel pushbuttons access test routines useful to perform maintenance of digital hardware.

HP-IB

Direct plotter control: all displayed information can be transferred to an HP-IB plotter with front panel pushbuttons.

Controller Interface Functions

Trace data transfer: all trace data values can be transferred to or from 853A with a controller.

Input messages: controller-input instructions or annotation can be displayed on either of two 60 character lines.

Display control: all trace processing functions can be remotely controlled.

Sweep control: analyzer sweeps can be initiated and monitored.

General

General Specifications

180-Series compatibility: the HP 8558B Spectrum Analyzer is compatible with the 180T-Series displays as well as the 853A². The 182T is a normal persistence cabinet style display; the 181T offers variable persistence and storage; the 181TR is a rack mount configuration with normal persistence. All 180T-Series displays provide non-buffered, rear panel, auxiliary outputs (for unattenuated vertical, horizontal, and penlift outputs). However, they do not offer the digital display, HP-IB and direct plotter control, nor the portability features of the 853A.

Temperature range: operating 0° to $+55^\circ\text{C}$; storage -40° to $+75^\circ\text{C}$.

EMI: conducted and radiated interference is within requirements of methods CE03 and RE02 of MIL STD 461A, CISPR Publication 11 (1975), and Messenpfaenger Postverfuegung 526/527/79 (Kennzeichnung Mit F-Nummer/Funkschutzzeichen).

Power: < 200 VA with display, 48 to 440 Hz (48 to 66 Hz at 220 or 240 Vac); with 853A: 100, 120, 220, or 240 Vac, $+5\%$, -10% ; with 180-series: 115 or 230 Vac, $\pm 10\%$.

Weight

Model 8558B: net, 5.5 kg (12 lb). Shipping 10.5 kg (23 lb).

Model 853A: net, 15.9 kg (35 lb). Shipping 18.6 kg (41 lb).

Model 853A Opt 001: net, 14.5 kg (32 lb.) Shipping, 17.3 kg (38 lb.).

Size

Model 853A/8558B: 158.8 H x 501.7 W x 524.5 mm D (6.25" x 19.75" x 20.65").

Model 853A Opt 001/8558B: 133 H x 425.5 W x 473.3 mm D (5.25" x 16.75" x 18.65").

Ordering Information

8558B Spectrum Analyzer

Opt 001: 75 Ω input, dBm calibration

Opt 002: 75 Ω input, dBmV calibration

Opt 910: Extra Operating and Service Manual

853A Portable Spectrum Analyzer Display

Opt 001: Full Module Bench/Rack Configuration

Opt 910: Extra Operation and Service Manual

182T Cabinet Style, Normal Persistence Display

180TR Rack Mount, Normal Persistence Display

181T Cabinet Style, Variable Persistence Display

181TR Rack Mount 181T Display

¹ Input not to exceed maximum levels.

² A simple modification is required for 8558B plug-ins with serial prefix 2145A and lower (modification kit, HP part number 00853-80058).

SIGNAL ANALYZERS

Spectrum Analyzer, 0.01 to 21 GHz

Models 8559A/853A

- Rugged portability
- Simple three-knob operation
- Direct plotter control
- Resolution bandwidths from 1 kHz to 3 MHz
- Absolute amplitude calibration in all bands

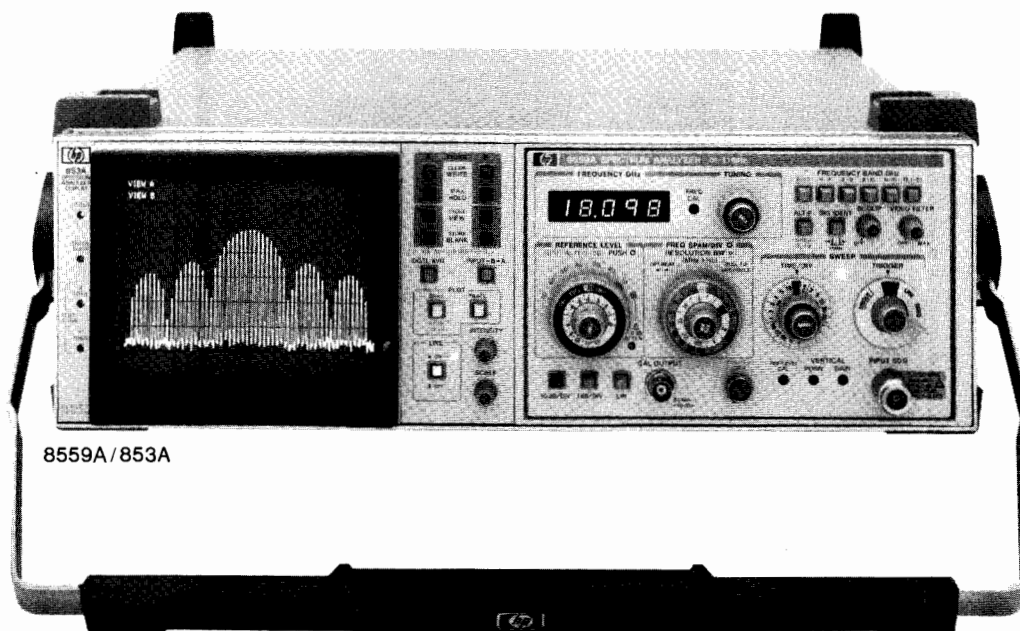

8559A/853A

8559A Spectrum Analyzer Plug-in

Performance Plus Economy

The 8559A is a 0.01 to 21 GHz spectrum analyzer plug-in for use with both the 853A and 180-series display. The high performance and convenient operation of this economical unit is ideally suited for a variety of applications in production, R&D or field service environments.

Simple 3-Knob Operation

Preset the 8559A to the color coded, "basic operation" settings, and use the coupled controls to make most measurements in three easy steps. Tune to the signal; the LED readout displays its frequency. Zoom-in on the signal by reducing the span width; the resolution bandwidth, video filter, and sweep time automatically change to an optimum value for a calibrated display. Then, change the reference level to bring the peak of the signal to the top of the screen for the most accurate amplitude measurement. A signal identifier is available in all bands to provide assurance of correct measurements.

Absolute Amplitude Calibration

Signal levels can be read directly in dBm from the CRT without the use of external standards or calculations. The signal level represented by the top CRT graticule line is always indicated by the reference level control, and vertical scale factors of 10 dB/Div, 1 dB/Div, or linear can be selected.

11870A Low Pass Filter (dc to 2.6 GHz)

For RF measurement applications needing extended coverage to 2.6 GHz, the 11870A low pass filter will reject signals above 3 GHz by more than 60 dB for image-free measurements over the entire 10 MHz to 2.6 GHz range.

853A Spectrum Analyzer Display

Digital Display

The 853A is a digital display mainframe for use with the 8559A spectrum analyzer plug-in. Signals are displayed on either of two independently stored digital traces. Display processing capabilities include maximum hold, digital averaging, and trace normalization for extended measurement capability. A built-in microprocessor manages the display operation and provides access to built-in test routines for display calibration and test (accessible via the front panel).

HP-IB Capability Includes Direct Plotter Control

A hard-copy record of the displayed traces and graticule can be made on a digital plotter via HP-IB by simply using the 853A's front-panel pushbuttons; a controller is not required. Although analyzer controls are not programmable, some HP-IB applications include

using a controller for recording trace data or for operator prompts on the 853A CRT. The digital display and processing functions can be remotely programmed, and analyzer sweeps can be initiated via HP-IB.

Two Configurations

The display is offered in two styles. The 853A (pictured) is a ruggedized, portable mainframe complete with tilt-bail handle and drip proof, protective front cover. The 853A is ideally suited for rugged, field service environments and any areas where system mobility is required. The 853A Option 001 offers the digital display in a full module bench or rack mount configuration.

8559A Specifications

Frequency Specifications

Frequency range: 0.01 to 21 GHz in six selectable ranges.

Frequency Spans

Fullband: displays entire spectrum of selected band.

Per division: 10 kHz to 200 MHz/div in a 1, 2, 5 sequence.

Zero span: analyzer functions as a manually tuned receiver.

Frequency Accuracy

Tuning accuracy: 0.01 to 3 GHz: $< \pm (1 \text{ MHz} + 0.3\% \text{ of center frequency})$; 3 to 21 GHz: $< \pm (5 \text{ MHz} + 0.2\% \text{ of center frequency})$.

Frequency span accuracy: $< \pm 5\%$ of displayed frequency separation.

Spectral Resolution

Resolution bandwidths: eight selectable resolution (3-dB) bandwidths from 1 kHz to 3 MHz in a 1, 3 sequence. Bandwidth and frequency span are independently variable or may be coupled for optimum display when control markers are aligned (▶◀).

Resolution bandwidth accuracy: 3-dB points are $< \pm 15\%$ (except for 3 MHz bandwidth: $< \pm 30\%$).

Selectivity: (60-dB/3-dB bandwidth ratio) $< 15:1$

Spectral stability: (fundamental mixing, bands 0.01–3 GHz and 6–9 GHz)

Residual FM: $< 1 \text{ kHz p-p}$ in 0.1 second.

Noise sidebands: $\geq 70 \text{ dB}$ down, $\geq 30 \text{ kHz}$ from center of CW signal with 1 kHz resolution bandwidth and full video filtering.

Amplitude Specifications

Amplitude range: -111 to $+30 \text{ dBm}$.

Maximum Input (damage) Levels

Total power: $+20 \text{ dBm}$ (100 mW, 2.2 Vrms) with 0 dB input attenuation; $+30 \text{ dBm}$ (1 watt, 7.1 Vrms) with $\geq 10 \text{ dB}$ input attenuation.

DC or AC (<100 Hz): ± 7.1 V.

Peak pulse power: +50 dBm (100 watts, 10 μ sec pulse width, 0.01% duty cycle) with ≥ 30 dB input attenuation.

Gain compression: <0.5 dB for a -10 dBm input level, with 0 dB input attenuation.

Average noise level: see table below for maximum average noise level with 1 kHz resolution bandwidth, 0 dB input attenuation, and maximum (MAX) video filtering.

Frequency Range (GHz)	Avg. Noise Level (dBm/1 kHz)	Frequency Response (\pm dB max.)	Amplitude Accuracy ¹ (\pm dB max.)
0.01-3	-111	1.0	2.3
6.0-9	-108	1.0	2.3
3.0-9	-103	1.5	2.8
9.0-15	-98	1.8	3.1
6.0-15	-93	2.1	3.4
12.1-18	-92	2.3	3.6
18.0-21	-90	3.0	4.3

Alternate IF: regular IF at 3.0075 GHz; alternate IF available at 2.9925 GHz for all frequency bands (minimum frequency is 25 MHz).

Calibrated Display Range

Log: 70 dB with 10 dB/div scale; 8 dB with 1 dB/div scale.

Linear: 8 divisions with linear (LIN) amplitude scale.

Amplitude Accuracy

Calibrator: -10 dBm \pm 0.3 dB (into 50 Ω), 35 MHz \pm 400 kHz.

Reference level: 10 dB steps and a 12 dB vernier for calibrated adjustment from -112 dBm to +60 dBm².

Step accuracy (with 0 dB input attenuation): -10 to -80 dBm: ± 0.5 dB; -10 to -100 dBm: ± 1.0 dB.

Vernier accuracy: ± 0.5 dB.

Frequency response: see table above; includes input attenuator, mixer flatness, and mixing mode gain variation (band to band), with 0 or 10 dB input attenuation.

Input attenuator: 0 to 70 dB, selectable in 10 dB steps.

Step accuracy: $< \pm 1.0$ dB per 10 dB step (0 to 60 dB, 0.01 to 18 GHz).

Maximum cumulative error: $< \pm 2.4$ dB (0 to 60 dB, 0.01 to 18 GHz).

Bandwidth Switching (amplitude variation)

3 MHz to 300 kHz: $< \pm 0.5$ dB.

3 MHz to 1 kHz: $< \pm 1.0$ dB.

Display Fidelity

Log incremental accuracy: ± 0.1 dB/dB from Reference Level.

Log maximum cumulative error: $\leq \pm 1.5$ dB over 70 dB range.

Linear accuracy: $\pm 3\%$ of Reference Level.

Spurious Responses

Second harmonic distortion: typically > 70 dB below a -40 dBm signal with 0 dB input attenuation.

Third order intermodulation distortion: typically > 70 dB below two -30 dBm input signals separated by ≥ 50 kHz with 0 dB input attenuation.

Residual responses: < -90 dBm with 0 dB input attenuation and no signal present at input (0.01³-3 GHz, 6-9 GHz).

Signal identifier: available in all frequency bands and spans, useable from 10 MHz to 100 kHz/div.

Sweep Characteristics

Sweep Time

Automatic: sweep time is automatically adjusted to maintain absolute amplitude calibration for any combination of frequency span, resolution bandwidth and video filter bandwidth.

Calibrated sweep times: 2 μ sec to 10 sec/div in a 1, 2, 5 sequence (except 2 sec/div), $\pm 10\%$ accuracy ($\pm 20\%$ for 5/10 sec/div).

Manual sweep: spectrum analyzer may be swept manually in either direction with front panel control.

Signal Input Characteristics

Input impedance: 50 Ω nominal; precision type-N female connector.

Input SWR: typically < 2.0 , 0 dB input attenuation; < 1.3 , 10 dB input attenuation.

Output Characteristics

Vertical output, AUX A: BNC output (50 Ω) provides detected video from 0 to 0.8 V for 8 division deflection on CRT display.

Penlift/blinking, AUX B: BNC output provides 0 V pen down/unblanking signal at low impedance; 15 V penlift/blinking at 10 k Ω impedance.

21.4 MHz IF output, AUX C: BNC output (50 Ω) provides a signal which is proportional to the RF input. Level is about -10 dBm (into 50 Ω) with a signal displayed at the Reference Level. Output is controlled by setting of Resolution BW, Input Atten, and Reference Level.

Horizontal output, AUX D: BNC output (5 k Ω) provides horizontal sweep from -5 to +5 V for full 10 division CRT horizontal deflection.

853A Characteristics

Digital Display

Traces: dual trace, digitally stored display with resolution of 481 horizontal by 801 vertical points for each trace.

Signal processing: maximum hold, digital averaging, and trace normalization.

Internal service routines: front panel pushbuttons access test routines to perform maintenance of digital hardware.

HP-IB

Direct plotter control: all displayed information can be transferred to an HP-IB plotter with front panel pushbuttons.

Controller Interface Functions

Trace data transfer: all trace data values can be transferred to or from 853A with a controller.

Input messages: controller-input instructions or annotation can be displayed on either of two 60 character lines.

Display control: all trace processing functions can be remotely controlled.

Sweep control: analyzer sweeps can be initiated and monitored.

General

General Specifications

180-Series compatibility: the HP 8559A Spectrum Analyzer is compatible with the 180T-Series displays as well as the 853A⁴. The 182T is a normal persistence cabinet style display; the 181T offers variable persistence and storage; the 181TR is a rack mount configuration with normal persistence. All 180T-Series displays provide non-buffered, rear panel, auxiliary outputs (for unattenuated vertical, horizontal, and penlift outputs). However, they do not offer the digital display, HP-IB and direct plotter control, nor the portability features of the 853A.

Temperature range operating 0° to +55°C; storage -40° to +75°C.

EMI: conducted and radiated interference is within requirements of methods CE03 and RE02 of MIL-STD 461A, CISPR Publication 11 (1975), and Messempefaenger Postverfuegung 526/527/79 (Kennzeichnung Mit F-Nummer/Funkschutzzeichen).

Power: < 200 VA with display, 48 to 440 Hz (48 to 66 Hz at 220 or 240 Vac); with 853A: 100, 120, 220, or 240 Vac, +5%, -10%; with 180 series: 115 or 230 Vac, $\pm 10\%$.

Weight

Model 8559A: net, 5.5 kg (12.1 lb). Shipping 9.1 kg (20 lb).

Model 853A: net, 15.9 kg (35 lb). Shipping 18.6 kg (41 lb).

Model 853A Opt 001: net, 14.5 kg (32 lb). Shipping, 17.3 kg (38 lb).

Size

Model 853A/8559A: 158.8 H x 501.7 W x 524.3 mm D (6.25" x 19.75" x 20.65").

Model 853A Opt 001/8559A: 133 H x 425.5 W x 473.7 mm D (5.25" x 16.75" x 18.65").

Ordering Information

8559A Spectrum Analyzer

Opt 910: Extra Operating and Service Manual

853A Portable Spectrum Analyzer Display

Opt 001: Full Module Bench/Rack Configuration

Opt. 910: Extra Operation and Service Manual

182T Cabinet Style, Normal Persistence Display

180TR Rack Mount Normal Persistence Display

181T Cabinet Style, Variable Persistence Display

181TR Rack Mount 181T Display

¹Using IF substitution, total accuracy is sum of frequency response, calibration, and reference level errors.

²Input level not to exceed maximum levels.

³0.02 GHz with Alternate IF ON.

⁴A simple modification is required for 8559A plug-ins with serial prefix 2208A and lower (modification kit, HP part number 00853-60059).

SIGNAL ANALYZERS

Modular Spectrum Analyzer System, 20 Hz to 40 GHz

Model 141T System

- 20 Hz to 18 GHz, external mixing to 40 GHz
- Absolute amplitude calibration
- Tracking generators for component test
- Tracking preselector simplifies measurements



Hewlett Packard's modular spectrum analyzer permits measurements at frequencies ranging from 20 Hz to 18 GHz with four plug-in tuning sections. For measurements in the 18 to 40 GHz an accessory external mixer may be used with the microwave tuning section. The modularity of the system allows you to keep pace with changing measurement requirements.

The modular spectrum analyzer is comprised of a mainframe/display, one tuning section, and one IF section. Each tuning section covers a different frequency range permitting purchase of those which best meet current requirements. The 8556A covers from 20 Hz to 300 kHz, the 8553B from 1 kHz to 110 MHz, the 8554B from 100 kHz to 1250 MHz, and the 8555A from 10 MHz to 18 GHz. The IF sections, the 8552A or 8552B, provide bandwidth/gain selection and detection. Unless otherwise noted, the specifications shown here apply to a modular spectrum analyzer which contains an 8552B IF section.

For swept frequency testing of components, the 8443A or 8444A Tracking Generator function as a swept signal source which, through locking, accurately tracks the frequency to which the analyzer is tuned. A microwave tracking preselector, the 8445B, simplifies measurements and improves the dynamic range of the 8555A Tuning Section for dense signal environments.

The modular spectrum analyzer displays amplitude and frequency accurately with a large dynamic range.

The following pages contain detailed performance specifications for each configuration of the spectrum analyzer, preselector, and tracking generators.

Absolute Amplitude Calibration

Calibrated frequency and amplitude measurements may be made over the entire frequency range. Logarithmic or linear scaling allow display of amplitude in dBm or voltage respectively. A warning light is provided to indicate uncalibrated conditions due to improper control settings.

Frequency Calibration

Three scan modes allow simple, accurate measurements. In the FULL SCAN mode the entire tuning section band is displayed. A marker is provided to identify and select signals of interest.

After a signal is selected in the FULL SCAN mode, switching to PER DIVISION mode allows analysis of the signal in narrow scans. Noise sidebands and low deviation FM are examples of measurements that might be made in this mode.

The analyzer can be used as a fixed tuned receiver by selecting the ZERO SCAN mode. In this mode the analyzer provides a time domain display with a calibrated time base, controlled by the scan time setting.

High Resolution

In frequency domain analysis it is often necessary to resolve close-in sidebands, such as line related modulation. Bandwidths as narrow as 10 Hz are provided in the 8553B to obtain this resolution. Use of such narrow bandwidths is made possible by frequency stabilization.

High Sensitivity, Low Distortion

For best measurement accuracy, a wide dynamic range is essential. Wide dynamic range requires both high sensitivity and low internal distortion.

Signals as low as -142 dBm can be measured using the 8553B tuning section. For most measurements the 141T Modular System offers in excess of 70 dB distortion free dynamic range. For many measurements with the 8555A Tuning section, the 8445B Preselector can increase dynamic range to greater than 100 dB.

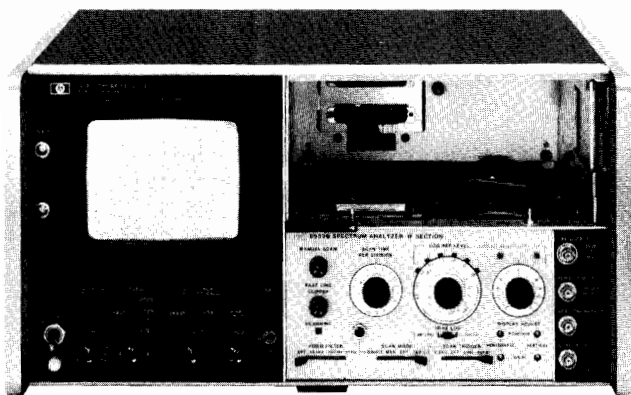

141T, 8552B

Mainframe/Storage Display

The 141T Mainframe provides variable persistence and storage. When narrow bandwidths are selected, sweep time must be reduced to maintain amplitude calibration. Variable persistence permits displayed traces of constant intensity even for long sweep times. The storage feature allows traces to be held for comparison or photographing. For measurements that do not require trace storage, the 140T Standard Persistence mainframe is available.

IF Section Features

In addition to providing calibrated bandpass filtering the IF Section offers several user convenience features. Selectable video filters improve signal discernibility when S/N is low and permit display of average noise level. Recorder outputs, compatible with analog XY recorders, are provided. Amplitude and frequency calibration from the front panel are possible using the internal calibration source.

Tracking Generators for Component Test

Tracking generators—leveled sources which track the tuned frequency of the analyzer—allow precise frequency measurements on two port devices with high dynamic range. Three tracking generators permit characterization of device performance up to 1500 MHz with a nominal dynamic range of 100 dB. The 8556B includes a tracking generator and the 8443A and 8444A may be used with the 8553B and 8554B Tuning Sections respectively.

8750A Storage-Normalizer

Digital trace storage and display with the 141T System is possible with the 8750A (Opt. 001) and an external oscilloscope. Digital storage provides a flicker-free display for any sweep speed and allows comparison of two traces. When a tracking generator is used, the normalization feature of the 8750A reduces the effect of system frequency response on the measurement.

General Specifications

141T Spectrum Analyzer System

Input impedance: 50 Ω nominal. Reflection coefficient <0.30 (1.85 SWR), input attenuator ≥ 10 dB.

Maximum input level: peak or average power +13 dBm (1.4 V ac peak), ± 50 V dc.

Attenuator: 0 to 50 dB in 10 dB steps.

Scan time: 16 internal scan rates from 0.1 ms/div to 10 sec/div in a 1, 2, 5 sequence, and manual scan (8552B only).

Scan Time Accuracy

0.1 ms/div to 20 ms/div: $\pm 10\%$.

50 ms/div to 10 s/div: $\pm 20\%$.

Scan Mode

Int: analyzer repetitively scanned by internally generated ramp; synchronization selected by scan trigger

Single: single scan with front panel reset.

Ext: scan determined by 0 to +8 volt external signal.

Manual: scan determined by front panel control.

Scan trigger: for internal scan mode, select between

Auto: scan free-runs.

Line: scan synchronized with power line frequency.

Ext: scan synchronized with >2 volt (20 volt max.) signal.

Video: scan internally synchronized to envelope of RF input.

Auxiliary Outputs

Vertical output: 0 to -0.8 V for full deflection.

Scan output: -5 V to $+5$ V for 10 div CRT deflection.

Pen lift output: 0 to 14 V (0 V, pen down).

Display Characteristics

141T, 140T

Plug-ins: accepts Models 8552A/B, 8553B, 8554B, 8555A and 8556A.

Cathode-Ray Tube Type

Model 141T: post-accelerator storage tube, 9000 volt accelerating potential; aluminized P31 phosphor.

Model 140T: post-accelerator, 7300 volt potential medium-short persistence (P39) phosphor.

Cathode-Ray Tube Graticule

Model 141T: 8 \times 10 division (approx, 7.1 cm \times 8.9 cm) parallax-free internal graticule.

Persistence, Model 141T Only

Normal: natural persistence of P31 phosphor (0.1 second).

Variable

Normal writing rate mode: continuously variable from less than 0.2 second to more than one minute.

Maximum writing rate mode: from 0.2 second to 15 seconds.

Erase: manual; erasure takes approximately 350 ms.

Storage time model 141T only: normal writing rate; more than 2 hours at reduced brightness (typically 4 hours).

Fast writing speed, model 141T only: more than 15 minutes.

EMI: conducted and radiated interference is in compliance with MIL-STD 461A Methods CEO3 and REO2, CISPR publication 11 (1975), and Messempefaenger-Postverfuegung 526/527/79 (Kennzeichnung Mit F-Nummer/Funkschutzzeichen).

Temperature range: operating, 0°C to $+55^{\circ}\text{C}$; storage, -40°C to $+75^{\circ}\text{C}$.

Power requirements: 100, 120, 220, or 240 V $\pm 5\%$. -10% . 50 to 60 Hz, normally less than 225 watts (includes plug-ins used).

Weight

Model 8552A or 8552B IF section: net, 4.1 kg (9 lb). Shipping 6.4 kg (14 lb).

Model 140T display section: net, 18 kg (40 lb). Shipping, 25 kg (54 lb).

Model 141T display section: net, 19.2 kg (43 lb). Shipping, 26 kg (57 lb).

Tuning section: see following pages.

Size: model 140T or 141T with plug-ins: 221 H \times 425 W \times 416 mm D (8.8" \times 16.8" \times 16.4").

Special order: chassis slides and adapter kit.

Ordering Information

140T Normal Persistence Display

Opt 908: Rack Flange Kit

141T Variable Persistence Display

Opt 908: Rack Flange Kit

8552A Economy IF Section

8552B High Resolution IF Section

SIGNAL ANALYZERS

141T Spectrum Analyzer System: 20 Hz to 300 kHz

Model 8556A

- Accurate signal level measurements (± 0.95 dB)
- Accurate frequency measurements (± 3 Hz)
- High sensitivity (-152 dBV)
- Built-in tracking generator

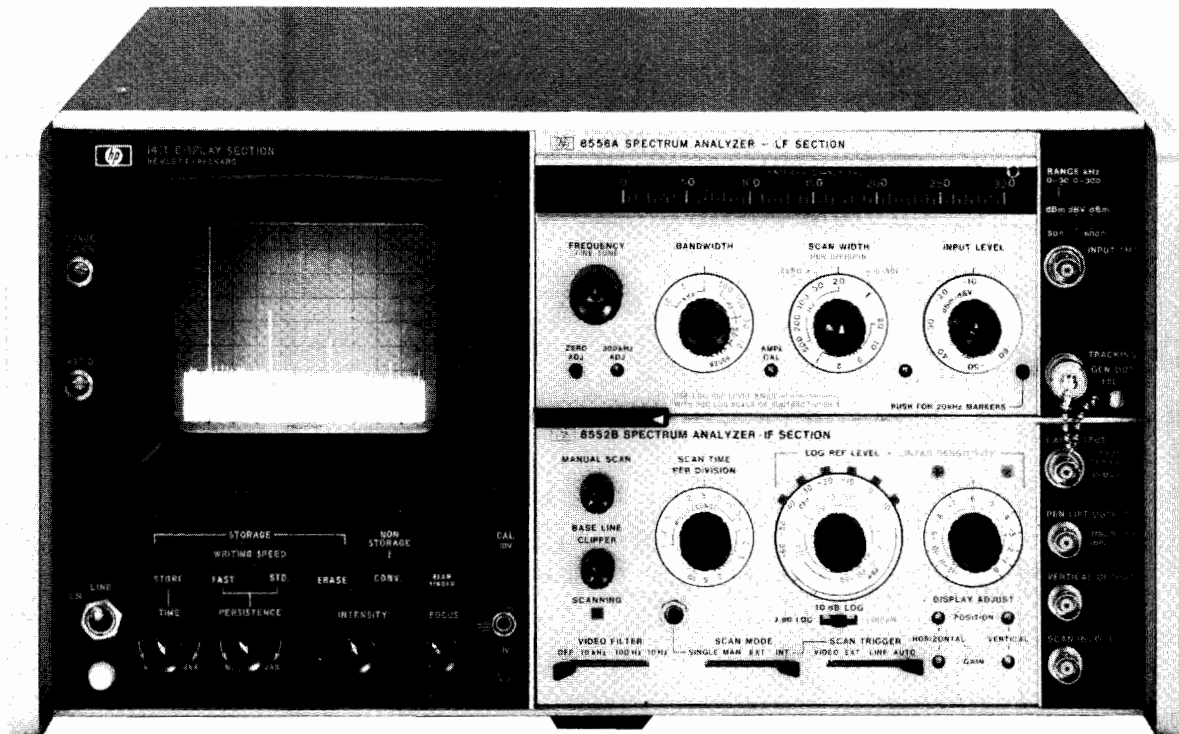

8556A (141T, 8552B)

Measurement Flexibility

The 8556A offers a frequency range of 20 Hz to 300 kHz. It is compatible with impedances normally encountered at audio frequencies. The input may be either balanced or unbalanced and measurement units may be dBV, dBm or Volts.

Frequency Range

In addition to the 300 kHz tuning scale, a 30 kHz tuning scale is provided for greater tuning resolution at low frequencies. The 8556A may be swept about the tuned frequency, from 0 Hz to a selectable stop frequency, or fixed tuned to any frequency in its tuning range. Crystal markers with 20 kHz spacing may be selected to ensure accurate frequency measurements.

Amplitude Calibration

The 8556A is calibrated for dBm in 600 and 50 ohms, as well as dBV and volts. Accurate reference level control (± 0.2 dB) and vernier (± 0.25 dB) allow accurate amplitude measurements when using the IF substitution method.

Resolution—Sensitivity

Bandwidths of from 10 Hz to 10 kHz are provided with the 8556A. The 10 Hz bandwidth is useful for measurements close to the carrier such as power line sidebands. The 10 Hz bandwidth together with the low noise figure of the 8556A, allow signals as low as -152 dBV (25 nV) to be measured.

Isolated Input

The isolated input prevents spurious signal pickup due to ground currents between the analyzer and the signal source. The high input impedance permits the use of an oscilloscope probe. An optional balanced input is transformer coupled to provide isolation and high common mode rejection.

Tracking Generator

The frequency of low level signals can be measured to ± 3 Hz accuracy with a frequency counter connected to the output of the built-in tracking generator. Swept insertion loss measurements with 140 dB dynamic range and return loss measurements are also possible using the tracking generator.

Specifications—with 8552B IF Section

Frequency Specifications

Frequency range: 20 Hz to 300 kHz. Tuning dial ranges of 0–30 kHz and 0–300 kHz.

Scan width: (on a 10-division CRT horizontal axis)

Per division: 10 calibrated scan widths from 20 Hz/div to 20 kHz/div in a 1, 2, 5 sequence.

0–10 f: 10 calibrated preset scans, from 200 Hz to 200 kHz in a 1, 2, 5 sequence. Analyzer scans from zero frequency to ten times the scan width per division setting.

Zero: analyzer is a fixed tuned receiver.

Frequency Accuracy

Center frequency accuracy: 0–30 kHz Range: ± 500 Hz; 0–300 kHz Range: ± 3 kHz.

Marker accuracy: RF markers every 20 kHz accurate to within $\pm 0.01\%$. Markers controlled by front panel on/off switch.

Scan width accuracy: frequency error between any two points on the display is less than $\pm 3\%$ of the indicated frequency separation.

Stability

Residual FM: sidebands >60 dB down 50 Hz or more from CW signal, scan time ≥ 1 sec/div, 10 Hz bandwidth.

Noise sidebands: more than 90 dB below CW signal, 3 kHz away from signal, with a 100 Hz IF bandwidth.

Frequency drift: less than 200 Hz/10 min.

Resolution

Bandwidth ranges: IF bandwidths of 10 Hz to 10 kHz are provided in a 1, 3, 10 sequence.

Bandwidth accuracy: individual IF bandwidth 3 dB points calibrated to $\pm 20\%$ (10 kHz bandwidth $\pm 5\%$).

Bandwidth selectivity: 60 dB/3 dB IF bandwidth ratios, with IF section: <11:1 for IF bandwidths from 10 Hz to 3 kHz; <20:1 for 10 kHz bandwidth. For 10 Hz bandwidth, 60 dB points are separated by less than 100 Hz.

Amplitude Specifications

Absolute Amplitude Calibration

Log Calibration Modes

dBV	0 dBV = 1 V rms
dBm-600 Ω	0 dBm = 1 mW-600 Ω
dBm-50 Ω	0 dBm = 1 mW-50 Ω

Input impedance is 1 M Ω . dBm ranges are referenced with input properly terminated externally.

Log calibration range: from -150 dBm/dBV to +10 dBm/dBV.

Log display range: 10 dB/div on a 70 dB display, or 2 dB/div on a 16 dB display.

Linear sensitivity: from 0.1 μ V/div to 1 V/div in a 1, 2, 10 sequence. Linear sensitivity vernier X1 to X0.25 continuously.

Dynamic Range

INPUT LEVEL control: -10 to -60 dBm/dBV in 10 dB steps. Accuracy ± 0.2 dB. Marking indicates maximum input levels for 70 dB spurious-free dynamic range.

Average noise level: (specified with a 600 Ω or less source impedance and INPUT LEVEL at -60 dBm/dBV)

Mode	1 kHz IF Bandwidth	10 Hz IF Bandwidth
dBm-50 Ω	<-122 dBm (180 nV)	<-142 dBm (18 nV)
dBm-600 Ω	<-130 dBm (250 nV)	<-150 dBm (25 nV)
dBV	<-132 dBV (250 nV)	<-152 dBV (25 nV)
Linear	<400 nV	<40 nV

Video filter: averages displayed noise; bandwidth of 10 kHz, 100 Hz, and 10 Hz. Bandwidth accuracy $\pm 20\%$.

Spurious responses: input signal level \leq INPUT LEVEL setting: out of band mixing responses, harmonic and intermodulation distortion products are all more than 70 dB below the input signal level 5 kHz to 300 kHz; 60 dB, 20 Hz to 5 kHz. Third order intermodulation products are more than 70 dB below the input signal level, 5 kHz to 300 kHz with signal separation >300 Hz.

Residual responses (no signal present at input): with the INPUT LEVEL at -60 dBm/dBV and the input terminated with 600 Ω or less, all line related residual responses from 0 to 500 Hz are below -120 dBm/dBV. All other residual responses are below -130 dBm/dBV.

Amplitude Accuracy	Log	Linear
Frequency response	± 0.2 dB	$\pm 2.3\%$
Amplitude display	± 0.25 dB/dB but not more than ± 1.5 dB over 70 dB display range	$\pm 2.8\%$ of full 8 div display

Log reference level control: provides 90 dB IF gain control in 10 dB steps. Accurate to ± 0.2 dB ($\pm 2.3\%$).

Log reference level vernier: provides continuous 12 dB range. Accurate to ± 0.1 dB ($\pm 1.2\%$) in 0, -6, -12 dB positions; otherwise ± 0.25 dB ($\pm 2.8\%$).

Amplitude measurement accuracy: ± 0.95 dB with proper technique.

General

Scan time: 16 internal scan rates from 0.1 ms/div to 10 sec/div in a 1, 2, 5 sequence.

Scan Mode

Int: analyzer repetitively scanned internally.

Ext: scan determined by 0 to +8 volt external signal.

Single: single scan actuated by front panel button.

Manual: scan determined by front panel control.

Input level: provides 50 dB control of input preamplification and attenuation to prevent input overload. INPUT LEVEL markings of -60 dBm/dBV to -10 dBm/dBV indicate maximum input level for a minimum of 70 dB spurious-free dynamic range. Accuracy ± 0.2 dB (2.3%).

Input impedance: 1 M Ω shunted by ≈ 32 pF.

Maximum input level: 10 V rms, ± 200 V dc. Ground terminals of BNC input connectors are isolated from the analyzer chassis ground to minimize ground loop pickup at low frequencies.

Maximum voltage, isolated ground to chassis ground: ± 100 V dc.

Isolated ground to chassis ground impedance: 100 k Ω shunted by approximately 0.3 μ F.

Gain compression: for input signal level 20 dB above INPUT LEVEL setting, gain compression is less than 1 dB.

Tracking Generator Specifications

Frequency range: tracks the analyzer tuning, 20 Hz to 300 kHz.

Amplitude range: continuously variable from 100 mV rms to greater than 3 V rms into an open circuit.

Amplitude accuracy: with TRACKING GEN LEVEL in CAL position and 20 kHz markers off, output level at 100 kHz is 100 mV ± 0.3 dB into an open circuit.

Frequency response: ± 0.25 dB 50 Hz to 300 kHz.

Output impedance: 600 Ω .

Residual FM: <1 Hz peak-to-peak.

Power requirements: 100, 120, 200, or 240 V +5%, -10%, 50 to 60 Hz, normally less than 225 watts.

Weight: Model 8556A LF section: net, 3.7 kg (8 lb). Shipping, 5.3 kg (12 lb).

Size: 102 H x 226 W x 344 mm D (4" x 8.9" x 13.5").

Specifications with 8556A Options 001, 002-Balanced Input

Amplitude

Log Calibration Modes-Balanced (bridged) Input

dBm-135 Ω (Option 001)	0 dBm = 1 mW-135 Ω
dBm-150 Ω (Option 002)	0 dBm = 1 mW-150 Ω
dBm-600 Ω	0 dBm = 1 mW-600 Ω
dBm-900 Ω	0 dBm = 1 mW-900 Ω

Input impedance is typically 15 k Ω . dBm ranges are referenced with input properly terminated externally.

Input

Maximum input levels: normal Mode, ± 20 V rms or ± 150 V dc for normal mode (symmetrical) signals between input signal connectors; Common Mode, 200 V rms at 60 Hz or ± 500 V dc for common mode (asymmetrical) voltages between input signal connectors and GUARD or instrument chassis; GUARD, ± 100 V dc from GUARD to instrument chassis. (GUARD to chassis impedance is approximately 100 k Ω shunted by 0.3 μ F.)

Balance (symmetry): 0 -30kHz Range, greater than 80 dB, 50 Hz to 1 kHz; 1 -300 kHz range, greater than 60 dB, 1 kHz to 20 kHz.

Ordering Information

8556A RF Section

Opt 001: Balanced input

Opt 002: Balanced input

SIGNAL ANALYZERS

141T Spectrum Analyzer System: 1 kHz to 110 MHz

Models 8553B & 8443A

- 10 Hz resolution bandwidth
- High sensitivity (-140 dBm)
- Accurate amplitude measurements (± 1.25 dB)
- 10 Hz frequency accuracy with tracking generator



8553B (141T, 8552B) 8443A

The 8553B covers the frequency range 1 kHz to 110 MHz. This frequency range includes audio, video, navigation aids, communications basebands, broadcast AM and FM, and TV. This analyzer features high sensitivity, stability and resolution. The 8443A Tracking Generator improves frequency measurement accuracy and provides a tracking source for swept frequency testing of components.

Frequency Range

The frequency range of the 8553B extends from audio through the FM broadcast band. In the PER DIVISION mode, scan widths from 200 Hz to 100 MHz can be selected. ZERO SCAN mode allows operation as a fixed tuned receiver with a time domain display. In addition to the full range dial scale, a 0-11 MHz dial scale provides better tuning resolution at low frequencies.

Resolution-Stability

Bandwidths ranging from 10 Hz to 300 kHz may be selected when using an 8553B. Wide bandwidths are useful for measurement of FM or other broadband spectra. The 10 Hz bandwidth allows measurement of 60 Hz sidebands which are greater than 60 dB down from the carrier. Low residual FM due to phase-lock stabilization makes this resolution possible. This low residual FM also permits characterization of oscillator stability.

Amplitude Calibration

The 8553B is calibrated for either dBm or Volts over the range -142 dBm (18 nV) to $+10$ dBm (0.7 V). An accurate amplitude reference is provided by the internal calibrator. This reference together with low frequency response variations (± 0.5 dB) make possible accurate measurements of absolute amplitude. Calibrated in-circuit made measurements may be made at frequencies from 100 kHz to 110 MHz when using the 1121A Active Probe with the 8553B.

Sensitivity

Low noise figure and 10 Hz bandwidth result in high sensitivity for the 8553B. In a 10 Hz bandwidth signal levels of -140 dBm may be measured. With the addition of a low noise preamp, such as the 8447, sensitivity can be improved by at least 15 dB.

8443A Tracking Generator-Counter

To complement the 8553B, the 8443A Tracking Generator provides a tracking source with a frequency range of 100 kHz to 110 MHz. A built-in counter permits precision frequency measurements and RF attenuators allow precise control of output amplitude.

Frequency Accuracy

Frequency measurements with an accuracy of ± 10 Hz are possible when using an 8443A. In the TRACK ANALYZER mode, the 8443A displays the counted frequency of a tunable marker. The RESTORE mode allows individual signals to be counted in a wide scan without fine tuning.

Swept Frequency Measurements

With the 8443A, the 8553B can be used to measure both insertion and return loss over the 100 kHz to 110 MHz frequency range. The excellent stability of the 8443A permits use of the 10 Hz bandwidth, providing a 130 dB dynamic range for swept frequency response measurements. A system (8553B/8443A) frequency response of ± 1.0 dB insures accurate characterization of DUT frequency response.

Specifications—with 8552B IF Section

Frequency Specifications

Frequency range: 1 kHz–110 MHz (0–11 MHz and 0–110 MHz tuning ranges).

Scan Width (on 10-division CRT horizontal axis)

Per division: 18 calibrated scan widths from 20 Hz/div to 10 MHz/div in a 1, 2, 5 sequence.

Preset: 0–100 MHz, automatically selects 300 kHz bandwidth IF Filter.

Zero: analyzer is fixed tuned receiver with selectable bandwidth.

Frequency Accuracy

Center frequency accuracy: the dial indicates the display center frequency within ± 1 MHz on the 0–110 MHz tuning range; ± 200 kHz on the 0–11 MHz tuning range with FINE TUNE centered, and temperature range of 20°C to 30°C.

Scan width accuracy: scan widths 10 MHz/div to 2 MHz/div and 20 kHz/div to 20 Hz/div: Frequency error between two points on the display is less than $\pm 3\%$ of the indicated frequency separation between the two points. Scan widths 1 MHz/div to 50 kHz/div: Frequency error between two points on the display is less than $\pm 10\%$ of the indicated frequency separation.

Resolution

Bandwidth: IF Bandwidths of 10 Hz to 300 kHz are provided in a 1, 3, 10 sequence.

Bandwidth accuracy: individual IF bandwidths' 3 dB points calibrated $\pm 20\%$ (10 kHz bandwidth $\pm 5\%$).

Bandwidth selectivity: 60 dB/3 dB IF bandwidth ratios: 10 Hz to 3 kHz bandwidths, $<11:1$, 10 kHz to 300 kHz bandwidths, $<20:1$; 60 dB points on 10 Hz bandwidth separated by <100 Hz.

Stability

Residual FM stabilized: sidebands >60 dB down 50 Hz or more from CW signal, scan time ≥ 1 sec/div, 10 Hz bandwidth (typically less than 1 Hz peak-to-peak).

Residual FM unstabilized: <1 kHz peak-to-peak.

Noise sidebands: more than 70 dB below CW signal, 50 kHz or more away from signal, with 1 kHz IF bandwidth.

Long term drift (after 1-hour warm-up), stabilized: 100 Hz/10 min; unstabilized: 5 kHz/min, 20 kHz/10 min.

Amplitude Specifications

Absolute Amplitude Calibration Range

Log: from -130 to $+10$ dBm, 10 dB/div on a 70 dB display or 2 dB/div on a 16 dB display.

Linear: from $0.1 \mu\text{V/div}$ to 100 mV/div in a 1, 2 sequence on an 8-division display.

Dynamic Range

Average noise level: <-110 dBm with 10 kHz IF bandwidth.

Video filter: averages displayed noise; 10 kHz, 100 Hz, and 10 Hz bandwidths.

Spurious responses: are below a -40 dBm signal at the input mixer as follows: All image and out-of-band mixing responses, harmonic and intermodulation distortion more than 70 dB down, 2 MHz to 110 MHz; more than 60 dB down, 1 kHz to 2 MHz. Third order intermodulation products more than 70 dB down, 1 kHz to 110 MHz (Signal separation >300 Hz).

Residual responses (no signal present at input): with input attenuation at 0 dB: <-110 dBm (200 kHz to 110 MHz); <-95 dBm (20 kHz to 200 kHz).

Amplitude Accuracy

Frequency response (Flatness: attenuator settings >10 dB): 1 kHz to 110 MHz

Amplitude Display

	Log	Linear
Frequency response (Flatness: attenuator settings >10 dB): 1 kHz to 110 MHz	± 0.5 dB	$\pm 5.8\%$
Amplitude Display	± 0.25 dB/dB but not more than ± 1.5 dB over the full 70 dB display range	$\pm 2.8\%$ of full 8 div deflection

Calibrator amplitude: -30 dBm, ± 0.3 dB

Calibrator frequency: 30 MHz, ± 3 kHz.

Log reference level control: provides 70 dB range (60 dB below 200 kHz), in 10 dB steps. Accurate to ± 0.2 dB ($\pm 2.3\%$, Linear Sensitivity).

Log reference level vernier: provides continuous 12 dB range. Accurate to ± 0.1 dB ($\pm 1.2\%$) in 0, -6 , and -12 dB positions; otherwise ± 0.25 dB ($\pm 2.8\%$).

Amplitude measurement accuracy: ± 1.25 dB with proper technique.

General

Input impedance: 50 Ω nominal, BNC connector. Reflection coefficient <0.13 (1.3 SWR), input attenuator ≥ 10 dB. A special 75 Ω 8553B/8552B is available.

Maximum input level: peak or average power $+13$ dBm (1.4 V ac peak), ± 50 V dc, 1 dB compression point, -10 dBm.

Scan time: 16 internal scan rates from 0.1 ms/div to 10 sec/div in a 1, 2, 5 sequence, or manual scan.

Scan Mode

Int: analyzer repetitively scanned internally.

Ext: scan determined by 0 to $+8$ -volt external signal.

Manual: scan determined by front panel control.

Attenuator: 0 to 50 dB, in 10 dB increments, coupled to Log Reference Level indicator; automatically maintains absolute calibration. Attenuator accuracy ± 0.2 dB.

Power requirements: 100, 120, 220, or 240 V $+5\%$, -10% , 50 to 60 Hz, normally less than 225 watts.

Weight: Model 8553B RF Section: net, 5.5 kg (12 lb). Shipping, 7.8 kg (17 lb).

Size: 102 H x 226 W x 334 mm D (4" x 8.9" x 13.5").

Tracking Generator-Counter (8443A)

Frequency range: 100 kHz to 110 MHz.

Amplitude range: <-120 dBm to $+10$ dBm in 10 and 1 dB steps with a continuous 1.2 dB vernier.

Amplitude Accuracy

Frequency response (flatness): ± 0.5 dB.

Absolute: 0 dBm at 30 MHz: ± 0.3 dB.

Output impedance: 50 Ω , BNC connector, ac coupled, reflection coefficient ≤ 0.09 (1.2 SWR) with output <0 dBm.

Counter

Display: 7 digits with 1 digit over-range. Reads to ± 10 Hz increments.

Resolution (gate time): 1 kHz (1 ms), 100 Hz (10 ms), 10 Hz (100 ms).

Accuracy: ± 1 count \pm time base accuracy.

Time base aging rate: $<3 \times 10^{-9}$ /day (0.3 Hz/day) after warm-up.

External counter inputs: 10 kHz to 120 MHz, 50 Ω , -10 dBm min.

Power: 100, 120, 220, or 240 V $+5\%$, -10% , 48 to 440 Hz 75 watts.

Weight: Model 8443A: net, 11.04 kg (24.3 lb). Shipping, 14.47 kg (31.9 lb).

Size: 88.2 H x 425 W x 467 mm D (3.5" x 16.8" x 18.4").

Ordering Information

8553B RF Section

8443A Tracking Generator-Counter

SIGNAL ANALYZERS

141T Spectrum Analyzer System: 100 kHz to 1250 MHz

Models 8554B & 8444A

- High resolution (100 Hz)
- Frequency response ± 1 dB
- Companion tracking generator
- Optional internal limiter



8554B (141T, 8552B) 8444A

The 8554B RF Section covers the frequency range from 100 kHz to 1250 MHz. This band includes baseband, AM/FM Broadcast, VHF/UHF TV, mobile communications, and VHF/UHF navigation systems. Typical measurements include modulation, intermodulation, harmonics and spurious. Noise power density and carrier to noise ratio can also be measured. The frequency response of filters, amplifiers, mixers or modulators can be measured and displayed when a companion tracking generator is used.

Absolute Calibration

Amplitude measurements can be made with an accuracy of ± 2.8 dB over the range +10 to -122 dBm. This accuracy can be improved to ± 1.75 dB with IF substitution techniques. The log display mode (dBm) provides a 70 dB calibrated range, while the linear display mode (volts) provides maximum resolution of $1 \mu\text{V}$ per division. The calibrated reference level (top graticule line) can be set with IF gain to values from +10 to -72 dBm. An UNCAL light warns of control settings which may cause loss of amplitude calibration.

Frequency Response

Excellent flatness (± 1 dB) insures high accuracies for relative amplitude measurements such as harmonic distortion. Full band sweep allows display of the entire tuning range, 100 kHz to 1250 MHz.

Frequency Resolution

Low residual FM allows selection of bandwidths as narrow as 100 Hz. This bandwidth provides the resolution needed to measure close-in sidebands such as those due to power line harmonics or third order

intermodulation distortion. Available bandwidths range from 100 Hz to 300 kHz in a 1, 3, 10 sequence. The filters used are synchronously-tuned which have an excellent response to pulsed signals and permit the lowest sweep time for a given bandwidth.

Sensitivity

High sensitivity (-122 dBm/100 Hz) and low spurious (-65 dBc) allow accurate measurements of low level signals such as might be encountered in EMI applications. The sensitivity/spurious performance also provides dynamic range required for signals with large amplitude separation such as intermodulation distortion or incidental AM.

Frequency Stabilization

Frequency stabilization reduces residual FM to less than 100 Hz peak-to-peak for scans of 200 kHz or less. The stabilization in narrow scans is implemented by phase-locking the local oscillators to a crystal reference.

8444A Tracking Generator

The 8444A Tracking Generator utilizes the LO's of the 8554B to generate an output signal whose frequency equals the tuned frequency of the 8554B. The tracking generator can provide a swept source for frequency response measurements. The 8444A also provides control of output signal amplitude to prevent overdriving the DUT.

For precise frequency measurements of low level signals, the tracking generator provides a constant amplitude signal which can be used to drive a frequency counter.

8554B Specifications—with 8552B IF Section

Frequency Specifications

Frequency range: 100 kHz to 1250 MHz.

Scan Width (on 10-division CRT horizontal axis)

Per division: 15 calibrated scan widths from 100 MHz/div to 2 kHz/div in a 1, 2, 5 sequence.

Preset: 0-1250 MHz, automatically selects 300 kHz bandwidth IF filter.

Zero: analyzer is fixed-tuned receiver.

Frequency Accuracy

Center frequency accuracy: the dial indicates the display center frequency within 10 MHz.

Scan width accuracy: frequency error between two points on the display is less than 10% of the indicated separation.

Resolution

Bandwidth: IF bandwidths of 0.1 to 300 kHz provided in a 1, 3, 10 sequence.

Bandwidth accuracy: individual IF bandwidth 3 dB points calibrated to $\pm 20\%$ (10 kHz bandwidth $\pm 5\%$).

Bandwidth selectivity: 60 dB/3 dB IF bandwidth ratio $< 20:1$ for IF bandwidths from 10 kHz to 200 kHz. 60 dB/3 dB bandwidth ratio $< 11:1$ for IF bandwidths 100 Hz to 3 kHz.

Stability (residual FM)

Stabilized: < 100 Hz peak-to-peak.

Unstabilized: < 10 kHz peak-to-peak.

Noise sidebands: more than 70 dB below CW signal, 50 kHz or more away from signal, with 1 kHz IF bandwidth.

Amplitude Specifications

Absolute Amplitude Calibration Range

Log: from -122 to $+10$ dBm. 10 dB/div on a 70 dB display, or 2 dB/div on a 16 dB display.

Linear: from $0.1 \mu\text{V/div}$ to 100 mV/div in a 1, 2 sequence on an 8-division display.

Dynamic Range

Average noise level: < -102 dBm with 10 kHz IF bandwidth.

Spurious responses: all image and out-of-band mixing responses, harmonic and intermodulation distortion products are more than 65 dB below a -40 dBm signal at the input mixer.

Residual responses (no signal present at input): with input attenuation at 0 dB: < -100 dBm.

Amplitude Accuracy

	Log	Linear
Frequency response (flatness)		
100 kHz to 1250 MHz	± 1 dB	$\pm 12\%$
Switching between bandwidths (at 25°C)	± 0.5 dB	$\pm 5.8\%$
Amplitude display	± 0.25 dB/dB but not more than ± 1.5 dB over the full 70 dB display range.	2.8% of full 8 div deflection

Calibrator Output

Amplitude: -30 dBm, ± 0.3 dB.

Frequency: 30 MHz, ± 3 kHz.

Log reference level control: provides 70 dB range (60 dB below 200 kHz), in 10 dB steps. Accurate to ± 0.2 dB ($\pm 2.3\%$, Linear Sensitivity).

Log reference level vernier: provides continuous 12 dB range. Accurate to ± 0.1 dB ($\pm 1.2\%$) in 0, -6 , and -12 dB positions; otherwise ± 0.25 dB ($\pm 2.8\%$).

Amplitude measurement accuracy: ± 1.75 dB with proper technique.

RF Input Specifications

Input impedance: 50 Ω nominal. Typical reflection coefficient < 0.30 (1.85 SWR), input attenuator ≥ 10 dB.

Maximum input level: peak or average power $+13$ dBm (1.4 V ac peak), ± 50 V dc.

General

Scan time: 16 internal scan rates from 0.1 ms/div to 10 sec/div in a 1, 2, 5 sequence, and manual scan.

Scan Time Accuracy

0.1 ms/div to 20 ms/div: $\pm 10\%$.

50 ms/div to 10 s/div: $\pm 20\%$.

Weight

Model 8554B RF section: net, 4.7 kg (10.3 lb). Shipping 7.8 kg (17 lb).

Size: 102 H x 226 W x 344 mm D (4" x 8.9" x 13.5").

8444A Specifications

Specifications for Swept Frequency Response

Measurements

Dynamic range: > 90 dB from spectrum analyzer 1 dB gain compression point to average noise level (approximately -10 dBm to -100 dBm). Spurious responses not displayed.

Gain compression: for -10 dBm signal level at the input mixer, gain compression < 1 dB.

Absolute Amplitude Calibration Range

Tracking generator (drive level to test device: 0 to -10 dBm continuously variable. 0 dBm absolutely calibrated to ± 0.5 dB at 30 MHz.

Frequency range: 500 kHz to 1250 MHz.

Frequency resolution: 1 kHz.

Stability

Residual FM (peak-to-peak): stabilized, < 200 Hz; unstabilized, < 10 kHz.

Amplitude Accuracy

System frequency response: ± 1.50 dB.

Tracking generator calibration: 0 dBm at 30 MHz to ± 0.5 dB.

Specifications for Precision Frequency Measurements

Frequency accuracy: for unknown signals ± 10 kHz. (Tracking drift typically 50 kHz/10 min after 2-hour warm-up). For points on frequency response curve, counter accuracy \pm Residual FM (200 Hz).

Counter Mode of Operation

Manual scan: scan determined either by front panel control of 8552B IF Section or by external scan signal provided by the 8444A.

Zero scan: analyzer is fixed-tuned receiver. Counter reads center frequency to accuracy of tracking drift.

Counter output level: typically 0.1 V rms.

Specifications for Sweep/CW Generator

Frequency: controlled by spectrum analyzer. Range 500 kHz to 1250 MHz with 8554B. Scan widths are as enumerated on this page.

Frequency accuracy: ± 10 MHz using spectrum analyzer tuning dial. Can be substantially improved using external counter output.

Flatness: ± 0.5 dB.

Spectral Purity

Residual FM (peak-to-peak): 200 Hz.

Harmonic distortion: 25 dB below output level (typical).

Nonharmonic (spurious) signals: > 35 dB below output level.

Long term stability: drift typically less than 30 kHz/hour when stabilized after 2-hour warm-up.

Sweep width: 20 kHz to 1000 MHz.

Sweep rates: selected by Scan Time per Division on spectrum analyzer.

General

Temperature range: operation, 0°C to 55°C , storage -40°C to 75°C .

EMI: conducted and radiated interference is in compliance with MIL-STD 461A Methods CE03 and RE02, CISPR publication 11 (1975), and Messempfaenger-Postverfuegung 526/527/79 (Kennzeichnung Mit F-Nummer/Funkschutzzeichen).

Power: 115 V and 230 V, 48 to 440 Hz, 12 watts max.

Weight: net, 7.1 kg (15.6 lb). Shipping, 9.5 kg (21 lb).

Size: 88.2 H x 425 W x 467 mm D (3.5" x 16.8" x 18.4").

Ordering Information

8554B RF Section

Opt 003: Internal Limiter

8444A Tracking Generator



SIGNAL ANALYZERS

141T Spectrum Analyzer System: 10 MHz to 40 GHz

Models 8555A, 8444A Option 059 & 8445B

- 10 MHz to 18 GHz, external mixing to 40 GHz
- High sensitivity (-125 dBm)
- 100 Hz resolution
- Companion tracking generator to 1.5 GHz



8555A (141T, 8552B) 8444A Opt 059, 8445B

The 8555A Tuning Section offers multiband coverage from 10 MHz to 18 GHz. The range can be extended to 40 GHz with the 11517A external waveguide mixer (see page 513). The 8555A provides high sensitivity (-125 dBm), high resolution (100 Hz) and frequency scans as wide as 8 GHz. The 8555A is well suited for measurements necessary during both the design and production phases of microwave devices and systems.

Amplitude Calibration

Absolute amplitude calibration permits accurate amplitude measurements over the range from +10 to -125 dBm. The exceptional flatness of the 8555A, which is ± 2 dB at 18 GHz, enhances the accuracy of relative power measurements.

High Sensitivity

With the 100 Hz bandwidth selected, the sensitivity of the 8555A is -125 dBm in the fundamental mixing band and -100 dBm in the 4th harmonic band. This sensitivity permits measurements of low level signals. When these signals are close to the noise floor, a video filter of 10 kHz, 100 Hz or 10 Hz can be selected to improve discernability of the signal.

High Resolution/Stability

The low residual FM of the 8555A (<100 Hz p-p) allows a 100 Hz bandwidth to be selected which permits the user to resolve sidebands due to low frequency modulations. The stability of the 8555A also allows measurement of the spectral purity of a DUT.



8445B Tracking Preselector

The 8445B Tracking Preselector contains a YIG filter which tracks the tuned frequency of the analyzer over the range 1.8 to 18 GHz. The preselector suppresses the image and multiple responses which result from harmonic mixing. The preselector can also reduce distortion and increase dynamic range when signal separation exceeds the preselector bandwidth. For tuned frequencies below 1.8 GHz, a low pass filter prevents image and multiple responses.

An optional LED display provides a readout of marker frequency with 1 MHz resolution.

8444A Option 059 Tracking Generator

The tracking generator provides a leveled, calibrated signal output with a frequency equal to the tuned frequency of the 8555A. This enables swept frequency tests such as insertion loss and return loss at frequencies up to 1500 MHz. With the addition of an external frequency counter, precise measurement of frequency is possible.

8555A Specifications—with 8552B IF Section

Frequency Specifications

Frequency range: 0.01–40 GHz.

Tuning Range

With internal mixer: 0.01–18.0 GHz.

With external mixer: 12.4–40 GHz.

Harmonic Mixing Mode

Signal identification: not required when preselector is used. The signal identifier allows positive identification of all responses.

Scan Width

Full scan: the width of the scan depends on mixing mode. Scan width = $n \times 2000$ MHz, where n is the mixing mode; e.g. for $n = 2$, scan width is 4 GHz. Maximum scan width full screen is 8 GHz with coaxial mixer. Preselector necessary to make wide scans usable.

Per division: 16 calibrated scan widths from 2 kHz/div to 200 MHz/div in a 2, 5, 10 sequence.

Zero scan: analyzer becomes fixed-tuned receiver.

Frequency Accuracy

Dial accuracy: $n \times (\pm 15 \text{ MHz})$ where n is the mixing mode.

Scan accuracy: frequency error between two points on the display is less than $\pm 10\%$ of the indicated separation.

Stability: residual FM stabilized < 100 Hz peak-to-peak (fundamental mixing).

Noise sidebands: for fundamental mixing. More than 70 dB below CW signal 50 kHz or more away from signal, with 1 kHz IF bandwidth and 100 Hz video filter.

Frequency Drift

Long term drift: at fixed center frequency after 2-hour warm-up (Typical).

Stabilized: ± 3.0 kHz/10 min.

Unstabilized: ± 25 kHz/10 min.

Stabilization range: first LO can be automatically stabilized to internal crystal reference for scan widths of 100 kHz/div or less.

Resolution

Bandwidth range: selectable 3 dB bandwidths from 100 Hz to 300 kHz in a 1, 3, 10 sequence.

Bandwidth shape: approximately gaussian.

Bandwidth selectivity: 11:1 to 20:1 (60 dB/3 dB).

Bandwidth accuracy: individual IF bandwidth 3 dB points calibrated to $\pm 20\%$ (10 kHz bandwidth, $\pm 5\%$).

Amplitude Specifications

Measurement Range

Log reference level: from -60 dBm to $+10$ dBm.

Linear sensitivity: from $0.1 \mu\text{V}/\text{div}$ to $100 \text{ mV}/\text{div}$.

Sensitivity and frequency response with internal coaxial mixer noise level: specified for 1 kHz bandwidth.

Frequency Response with 10 dB Input Attenuator Setting

Frequency Range (GHz)	Mixing Mode (n)	Average Noise Level (dBm max.)	Frequency Response* (dB max.)
0.01-2.05	1-	-115	± 1.0
1.50-3.55	1-	-117	± 1.0
2.07-6.15	2-	-108	± 1.3
2.60-4.65	1+	-117	± 1.0
4.11-6.15	1+	-115	± 1.0
4.13-10.25	3-	-103	± 1.5
6.17-10.25	2+	-105	± 1.5
6.19-14.35	4-	-95	± 2.0
8.23-14.35	3+	-100	± 2.0
10.29-18.00	4+	-90	± 2.0

*Includes mixer frequency response, RF attenuator frequency response, mixing mode gain variation, RF input VSWR.

Sensitivity and Frequency Response with 11517A External Waveguide Mixer and Appropriate Waveguide Tapers

Average Noise Level 10 kHz Bandwidth (dBm typical)

Frequency Range (GHz)	Mixing Mode (n)	Average Noise Level (dBm)
12.4-18.0	6-	-90
18.0-26.5	6+	-85
26.5-40.0	10+	-75

Frequency response: typically ± 3 dB over 1 GHz frequency scans.

Residual responses: referred to input on fundamental mixing: < -90 dBm.

Display Range

Log: 70 dB, 10 dB/div and 2 dB/div, expanded on a 16 dB display.

Linear: from $0.1 \mu\text{V}/\text{div}$ to $100 \text{ mV}/\text{div}$ in a 1, 2, sequence on an 8-division display.

Spurious Responses Due to Second Harmonic Distortion with Preselector

Frequency Range	Power Incident on Input Mixer	2nd Harmonic Distortion
0.01-1.85 GHz	-40 dBm	-63 dB
1.85-18.0 GHz	0 dBm	-100 dB

Spurious Responses Due to Third Order Intermodulation Distortion with Preselector

Frequency Range	Signal Separation	Power Incident on Input Mixer	Third Order Intermodulation Distortion
0.01-18.0 GHz	> 1 MHz < 20 MHz	-30 dBm	-70 dB
0.01-1.85 GHz	> 70 MHz	-30 dBm	-70 dB
1.85-18.0 GHz	> 70 MHz	0 dBm	-100 dB

Video filter: post detection filter used to average displayed noise. Nominal bandwidths: 10 kHz, 100 Hz, and 10 Hz.

Gain compression: for internal mixer gain compression < 1 dB for -10 dBm peak or average signal level to input mixer. 11517A External Mixer (12.4-40 GHz) gain compression < 1 dB for -15 dBm peak or average signal level to input mixer.

Amplitude Accuracy

IF gain variation with different bandwidth settings: (at 20°C .)

Log: ± 0.5 dB.

Linear: $\pm 5.8\%$



SIGNAL ANALYZERS

141T Spectrum Analyzer System: 10 MHz to 40 GHz

Models 8555A, 8444A & 8445B (cont.)

Amplitude Display

Log: ± 0.25 dB/dB, but not more than ± 1.5 dB over the full 70 dB display range.

Linear: $\pm 2.8\%$ of full 8-division deflection.

Log reference level: accurate to ± 0.2 dB ($\pm 2.3\%$ linear sensitivity).

Log reference level vernier: accurate to ± 0.1 dB (1.2%) in 0, -6, and -12 dB positions; otherwise, ± 0.25 dB ($\pm 2.8\%$).

Input attenuator range: 0-50 dB in 10 dB steps, manual safety lock-out for 0 dB position.

Frequency response: typically ± 0.6 dB from 10 MHz to 18 GHz.

Calibrator output: amplitude -30 dBm, ± 0.3 dB. Frequency 30 MHz ± 3 kHz.

Absolute calibration accuracy: overall accuracy is a function of measurement technique. With the appropriate technique, absolute accuracy of ± 1.6 dB (fundamental mixing) and ± 2.6 dB (4th harmonic mixing) is achievable.

Input Characteristics

Input impedance: 50 ohms nominal (0.01-18 GHz).

Reflection coefficient: < 0.130 (1.30 SWR) for input RF attenuator settings ≥ 10 dB.

Maximum input level: peak or average power +13 dBm (1.0 V ac rms) incident on mixer (+30 dBm with Opt 002), +33 dBm incident on input attenuator.

RF input connector: type N female.

LO emission: -10 dBm without preselector, -80 dBm with preselector over recommended operating ranges (10 dB input attenuator setting).

General

Scan time: 16 internal scan rates from 0.1 ms/div to 10 sec/div in a 1, 2, 5 sequence.

Power requirements: 100, 120, 220 240 V +5%, -10%, 50-60 Hz, normally less than 225 watts (varies with plug-in units used).

Weight: net, 16.8 kg (14.9 lb). Shipping, 8.7 kg (19 lb).

Size: 102 H x 226 W x 344 mm D (4" x 8.9" x 13.5").

Specifications with Option 002;

Internal Limiter Installed

All specifications are the same as for the standard unit except the following:

Frequency range: 0.1-12.4 GHz, usable over 0.01-18 GHz range.

Maximum Input Level

Continuous: 1 W (+30 dBm).

Pulse: 75 watts peak, pulse width ≤ 1 μ s, 0.001 duty cycle.

Reflection coefficient: < 0.33 (2.0 SWR).

Frequency response (flatness): $< \pm 0.5$ dB degradation in response, 0.1-12.4 GHz.

8445B Tracking Preselector

Frequency Specifications

Frequency range: dc-1.8 GHz low-pass filter. 1.8-18 GHz tracking filter.

Tracking filter 3 dB bandwidth: typically 20-45 MHz.

Tracking filter skirt roll-off: characteristics of a three-pole filter. (Nominal: 18 dB/octave.)

Insertion Loss

	Frequency	Insertion Loss (Except Opt. 004)	Insertion Loss (Opt. 004)
Low-Pass Filter	DC-1.8 GHz	< 2.5 dB	*
	@2.05 GHz	> 50 dB	*
Tracking Filter	1.8-12 GHz	< 8 dB	< 7 dB
	12-18 GHz	< 10 dB	< 8 dB

*Low-Pass Filter deleted with Opt 004.

Typical Preselector Minimum Insertion Loss at 25°C.

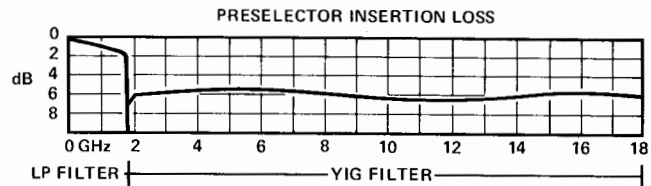

Out-of-band rejection: for YIG filter 1 GHz from center of pass-band > 70 dB.

Digital Frequency Readout (option 003)

Function

Full scan mode: displays frequency at inverted marker.

Per division scan: displays center frequency.

Manual or remote operation of preselector: displays tuned frequency of filter.

Resolution: 1 MHz.

Accuracy: 0.01-1.0 GHz: ± 6 MHz.

1.0-4.0 GHz: ± 8 MHz.

4.0-18 GHz: $\pm 0.2\%$

Input Specifications

Input connector: precision Type N female.

Input VSWR: typically < 2.0 (1.8-18 GHz).

Limiting level: (maximum input level for < 1 dB signal compression), $> +5$ dBm.

Damage level: $> +20$ dBm.

General

Remote function: YIG filter frequency can be set by externally supplied voltage.

Power requirements: 100, 120, 220, or 240 V + 5%, -10%, 48 to 440 Hz, less than 110 watts.

Weight: net, 8.8 kg (19.5 lb). Shipping, 11.9 kg (26 lb).

Size: 88.2 H x 425 W x 467 mm D (3.5" x 16.8" x 18.4").

8444A Opt 059 Tracking Generator

Frequency range: 0.5 MHz to 1500 MHz.

Frequency resolution: 1 kHz.

Residual FM (peak-to-peak): 200 Hz (stabilized).

Amplitude Range

Spectrum analyzer display: from -130 dBm to +10 dBm, 10 dB/div on a 70 dB display or 2 dB/div on a 16 dB display (8552B only).

Tracking generator (drive level to test device): 0 to -10 dBm continuously variable.

Amplitude Accuracy

System frequency response: ± 2.7 dB.

Tracking generator calibration: 0 dBm at 30 MHz to ± 0.5 dB.

Dynamic range: > 90 dB.

Counter output: typically 0.1 V rms.

General

Power: 115 V and 230 V, 48 to 440 Hz, 12 watts max.

Weight: net, 7.1 kg (15.6 lb). Shipping, 9.5 kg (21 lb).

Size: 85.2 H x 425 W x 467 mm D (3.5" x 16.8" x 18.4").

Ordering Information

8555A Tuning Section

Opt 001: APC-7 connectors

Opt 002: Internal limiter

Opt 005: Video tape

8445B Tracking Preselector, dc -18GHz

Opt 001: APC-7 connectors

Opt 002: Add manual controls

Opt 003: Add digital frequency readout

Opt 004: Delete low-pass filter

Opt 005: Delete interconnect rigid coax

8444A Opt 059 Tracking Generator

11517A External Mixer (taper section req'd)

11518A Taper Section, 12.4 to 18 GHz

11519A Taper Section, 18 to 26.5 GHz

11520A Taper Section, 26.5 to 40 GHz



- Low conversion loss
- Individually amplitude calibrated

- No bias or tuning adjustments
- High 100 mW safe input level

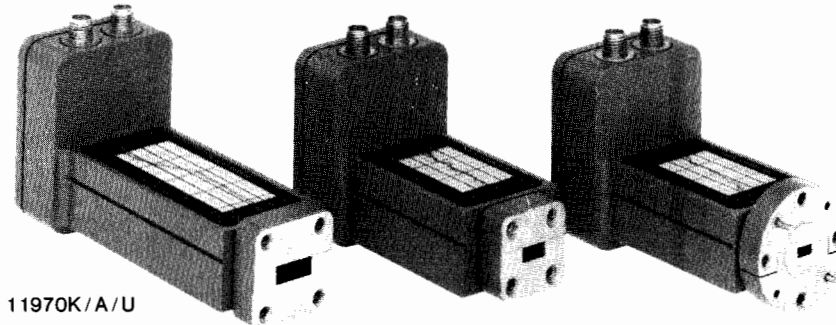

11970K/A/U

11970 and 11971: Exceptional Performance

The 11970 and 11971 Series of waveguide mixers are general purpose harmonic mixers employing a state-of-the-art, dual-diode design to achieve very flat frequency response and low conversion loss. Mixers are available in three waveguide frequency bands: 11970K/11971K: 18 to 26.5 GHz; 11970A/11971A: 26.5 to 40 GHz; and 11970U: 40 to 60 GHz. The 11970K/A/U mixers are designed for a LO of 3 to 6.1 GHz and the 11971 K/A mixers are optimized for a 2 to 4.5 GHz LO. Conversion loss of each mixer is calibrated to an accuracy of ± 2.0 dB.

Easy to Use

The excellent frequency response and low conversion losses of the 11970 and 11971 Harmonic Mixers are achieved without external dc bias or tuning stubs. With no adjustments to make, the measurement process for a manual operator is simplified, as well as the software and computer controlled hardware of an automated measurement system.

11517A Harmonic Mixer

The low cost and wide frequency range of the 11517A Harmonic Mixer provides a very economical solution covering 12.4 to 40 GHz for measurements not requiring amplitude calibration. Making measurements in more than one waveguide band is accomplished quickly and easily with a change of the waveguide adapter. The IF range of DC to 2 GHz and LO range of 2 to 6 GHz makes this biased mixer compatible with a wide range of test instruments.

Frequency Extenders for Spectrum Analyzers

The 11970 and 11971 Harmonic Mixers are fully compatible with the HP 8566A and HP 8569B Spectrum Analyzers respectively. The HP 11975A 2 to 8 GHz Amplifier provides the optimum LO power level to the mixers from these spectrum analyzers. The low conversion loss of the mixers yields excellent sensitivity over the full waveguide band without the inconvenience of any signal-peaking adjustments. Very accurate frequency and amplitude measurements are read directly from the spectrum analyzer's display after calibration using each mixer's individual calibration report.

The 11517A Harmonic Mixer provides a very economical frequency extension for the 8555A and 8565A Spectrum Analyzers. DC bias for the 11517A is provided by the spectrum analyzers and the built-in signal identifier allows quick verification of the frequency of any signal displayed.

11970 and 11971 Specifications

IF range: DC to 1300 MHz.
LO amplitude range: +14 to +19 dBm, +16 dBm optimum.¹
Calibration accuracy: ± 2.0 dB with optimum LO amplitude.
Typical RF input SWR: < 2.2:1.
Bias requirements: None.
Typical odd order suppression: > 20 dB.
Maximum CW RF input level: +20 dBm (100 mW).
Maximum peak pulse power: +24 dBm (250 mW) with <1 usec pulse (avg. power: +20 dBm).
Environmental: Meets MIL-T-28800C, Type III, Class 5, Style C.
IF/LO connectors: SMA female.

11970 Series Specifications

LO input frequency range: 3.0 to 6.1 GHz.

Model	Frequency Range (GHz)	LO Harmonic Number	Maximum Conversion Loss (dB)	8566A Noise Level, 1 kHz BW (dBm)	Frequency Response (dB)	8566A Amplitude Accuracy (corr'd, dB)	Typical Gain Compression (<1 dB, dBm)
11970K	18-26.5	6	24	-110	± 1.9	± 3.2	-3
11970A	26.5-40	8	26	-108	± 1.9	± 3.2	-5
11970U	40-60	10	28	-106	± 1.9	± 3.2	-7

11971 Series Specifications

LO input frequency range: 2.0 to 4.5 GHz.

Model	Frequency Range (GHz)	LO Harmonic Number	Maximum Conversion Loss (dB)	8569B Noise Level, 1 kHz BW (dBm)	Frequency Response (dB)	8569B Amplitude Accuracy (corr'd, dB)	Typical Gain Compression (<1 dB, dBm)
11971K	18-26.5	6	24	-110	± 2.1	± 3.3	-3
11971A	26.5-40	10	28	-106	± 2.1	± 3.3	-7

11517A Specifications

IF range: DC to 2000 MHz.
LO frequency range: 2.1 to 6.1 GHz.
LO amplitude range: 0 to +10 dBm, +10 dBm optimum.¹
Typical flatness: (with bias peaked): ± 3 dB, over 1 GHz frequency span.
Maximum CW RF input level: +10 dBm (10 mW).
Typical DC bias range: 0 to 3.5 mA.
Typical 3 dB gain compression level: -15 dBm.
Noise level (using 8555A or 8565A with 1 kHz BW): -85 dBm, 12.4 to 18 GHz; -80 dBm, 18 to 26.5 GHz; -70 dB, 26.5 to 40 GHz.
Waveguide adapters: 12.4-18 GHz: 11518A; 18-26.5 GHz: 11519A; 26.5-40 GHz: 11520A.

Ordering Information

11970K 18 to 26.5 GHz Mixer
11970A 26.5 to 40 GHz Mixer
11970U 40 to 60 GHz Mixer
11970T 18 to 40 GHz Mixer Set and Case
Opt 001: Adds 40 to 60 GHz Mixer to 11970T
11971K 18 to 26.5 GHz Mixer
11971A 26.5 to 40 GHz Mixer
11971T 18 to 40 GHz Mixer Set and Case
Opt 009: Mixer Connection Set contains three 1 meter low-loss SMA cables for use with any of the mixers listed above.
11517A Harmonic Mixer (Waveguide Adapter required)
11518A 12.4 to 18 GHz Waveguide Adapter
11519A 18 to 26.5 GHz Waveguide Adapter
11520A 26.5 to 40 GHz Waveguide Adapter
11975A 2 to 8 GHz Amplifier

¹ The HP 11975A Amplifier or a similar amplifier with leveled output power (typically ± 0.5 dB) can be used to provide sufficient LO power to the mixers.

SIGNAL ANALYZERS

Spectrum Analyzer Accessories

Models 11975A, 8447 Series & 11970/11971 Series

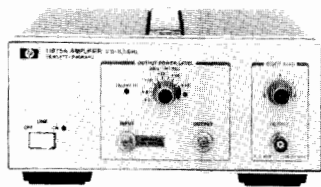

11975A

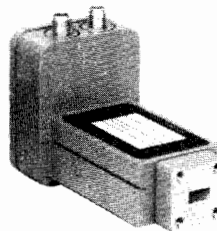

11970/11971 Series

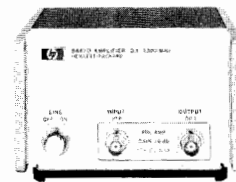

8447 Series



11693A



11867A



11694A

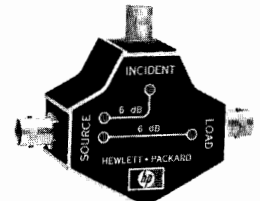

8721A



8406A



1121A

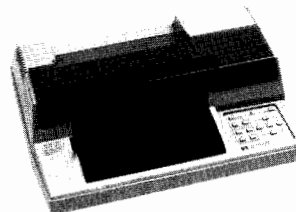

7470A

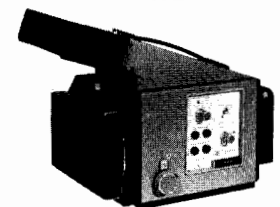

197B

8447 Series Amplifiers (0.1 to 1300 MHz)

The 8447 Series Amplifiers feature low noise and wide bandwidth. This makes them ideal for improving spectrum analyzer sensitivity and noise figure while providing input isolation. Accurate measurements over a wide frequency range are assured due to the broad frequency coverage, flat frequency response, and low distortion of these amplifiers. (See page 74.)

11975A Amplifier (2 to 8 GHz)

A wide variety of sources can be leveled to ± 1 dB and amplitude calibrated up to +16 dBm using the 11975A in a stimulus response system. As a preamp, the small signal gain of the 11975A varies between 9 and 15 dB depending on the frequency. For measurements above 18 GHz, the 11975A is ideal for amplifying the local oscillator signal from a spectrum analyzer or network analyzer to drive a waveguide mixer like the 11970 or 11971 Series Harmonic Mixers. (See page 72.)

11970 and 11971 Series Harmonic Mixers (18 to 60 GHz)

Each of these mixers provides low conversion loss and flat frequency response (typically ± 1.5 dB) over a full waveguide band of the 18 to 60 GHz frequency range. Optimized for 2 to 6 GHz local oscillator signals, the mixers are characterized for conversion loss and require no dc bias or tuning adjustments which could affect measurement accuracy and repeatability. (See page 513.)

11867A and 11693A Limiters

The input circuits of spectrum analyzers, counters, amplifiers, and other instrumentation is protected against high power levels with minimum affect on measurement performance. The 11867A RF Limiter (dc-1800 MHz) begins reflecting signal levels over 1 milliwatt without damage up to 10 watts avg. power and 100 watts peak power. Insertion loss is < 0.75 dB. The 11693A Microwave Limiter (0.1-12.4 GHz, useable to 18 GHz) guards against input signals over 1 milliwatt up to 1 watt avg. power and 10 watts peak power.

11694A 75 Ω Matching Transformer (3 to 500 MHz)

Allows measurements in 75 Ω systems while retaining amplitude calibration. VSWR is < 1.2 , and insertion loss is < 0.75 dB. See Options 001 and 002 for 75 Ω versions of the 8557A and 8558B.

8721A Directional Bridge (100 kHz to 100 MHz)

For making return loss measurements using a swept source such as the 8443A Tracking Generator and a spectrum analyzer. (See page 457 under "11652A: Directional Bridge".)

1121A Active Probe (0.1 to 500 MHz)

Provides high impedance input (> 100 k Ω shunted by < 3 pF) input to spectrum analyzer for measurements on sensitive circuits. Probe power is supplied by most HP Spectrum Analyzers and flat response with unity gain assures accurate, convenient measurements. (See page 457.)

8406A Frequency Comb Generator

Produces frequency markers at 1, 10, and 100 MHz increments accurate to $\pm 0.01\%$ and useable to beyond 5 GHz. An external oscillator can be used to generate precision interpolation sidebands. For an internal comb generator option to the 8569B, see page 493.

7470A Plotter

Produce hard copy records of measurement data in either a computer-based system or directly from a plotter-controlling instrument. Plotter controls on the 8569B Spectrum Analyzer or the 853A Spectrum Analyzer Display send the displayed information directly to the 7470A. (See page 628.)

197B CRT Camera

For a permanent record of a CRT display. See page 209 for the necessary adapters.

Ordering Information

- 8447A 0.1 to 400 MHz Preamp
- 8447D 0.1 to 1300 MHz Preamp
- 8447E 0.1 to 1300 MHz Power Amplifier
- 8447F 0.1 to 1300 MHz Preamp and Power Amplifier
- 11975A 2 to 8 GHz Amplifier
- 11970/11971 Series Harmonic Mixers see page 513
- 11867A RF Limiter
- 11693A Microwave Limiter
- 11694A 75 Matching Transformer
- 8721A Directional Bridge
- 1121A Active Probe
- 8406A Frequency Comb Generator
- 7470A Plotter
- 197B CRT Camera

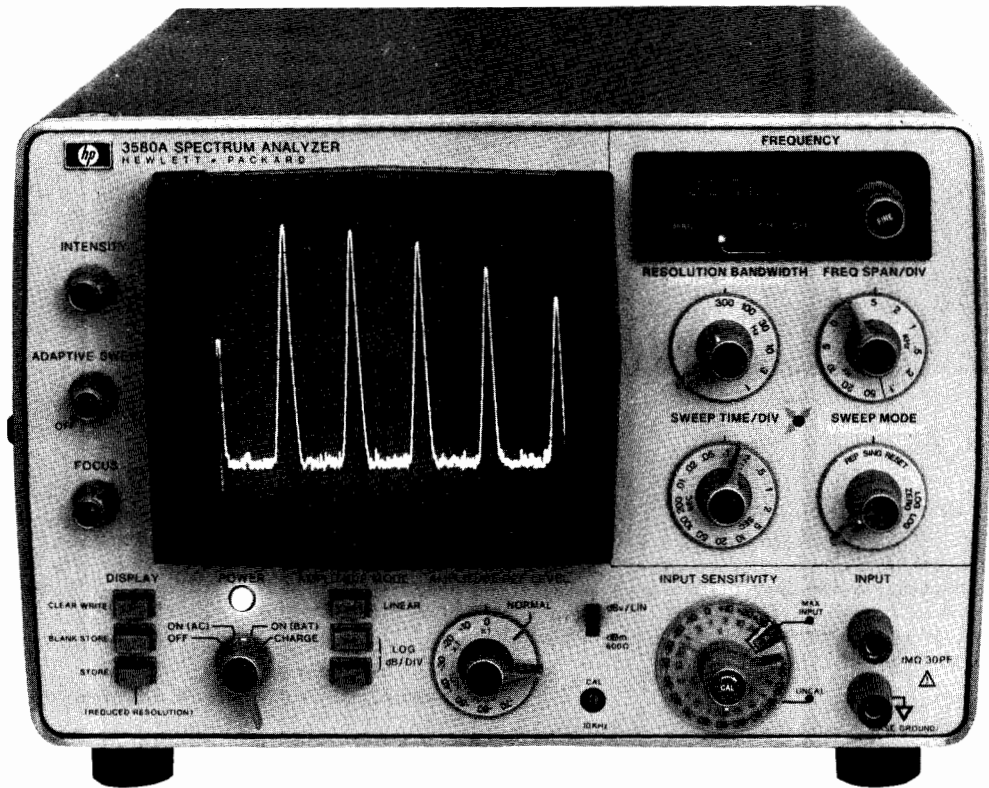

Description

Hewlett Packard's 3580A Spectrum Analyzer is a low frequency high performance analyzer. Its 1 Hz bandwidth allows the user to examine noise and extraneous signal content close in to a signal of interest.

For low frequency applications where sweep speeds can be slow and time-consuming, a special feature, adaptive sweep, allows the user to set a threshold above which only the spectra of interest are observed. In this mode, the CRT is rapidly swept. When a signal is encountered, the sweep slows down to reproduce full response. A factor of ten speed gain is possible.

Digital storage is another important feature which enhances the display for slowly swept low frequency signals. The analyzed signals are digitized and stored in memory. Trace information is then read from memory at a rate appropriate for obtaining an analog-like display.

Digital Storage for Spectra Comparison

Digital storage makes it possible to store one or two traces. When two are stored, both may be simultaneously displayed for easy comparison as shown below.

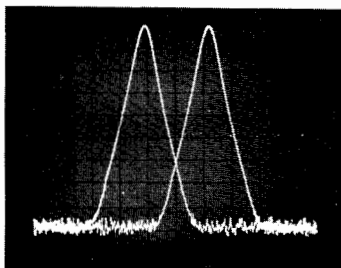

Adaptive Sweep

A tremendous savings in sweep time can be achieved by using adaptive sweep. In the left trace below, over 80 dB of dynamic range is used to look at low level signals and noise. Two hundred seconds were required to make the sweep. In the right trace, the baseline is raised to give 50 dB of dynamic range. Noise and other responses are not analyzed so the sweep now takes only 14 seconds.

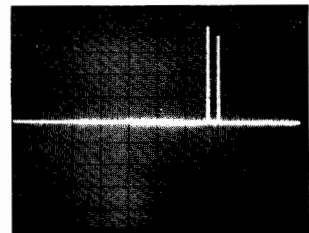
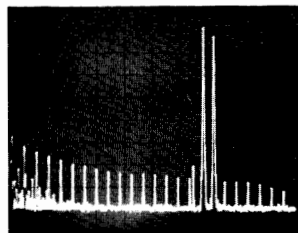

1 Hz Bandwidth

When using a 1 Hz bandwidth 60 Hz line related spectra are clearly exposed as shown in the left trace. An analysis of the same signal with a 10 Hz bandwidth will not resolve the line related spectra as shown on the right.

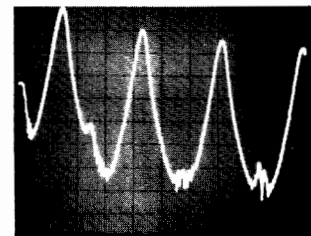
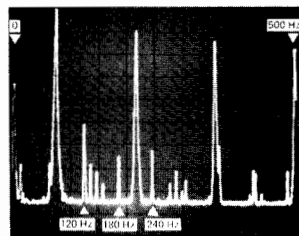

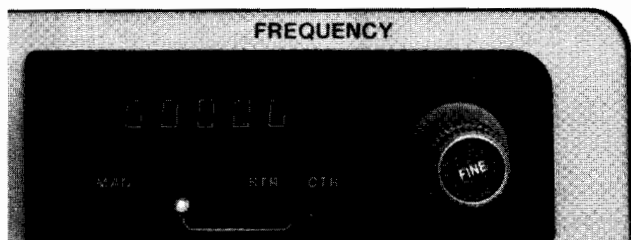

Digital Frequency Display

This display provides 1 Hz resolution for setting analysis range and for determining tuned frequency. In the automatic sweep modes, the sweep start or center frequency is displayed. In the manual sweep mode, actual tuned frequency is indicated. This mode effectively provides a cursor function for easy and accurate determination of the frequency at any point on the screen.

Internal Calibration Signal

A 10 kHz pulse derived from a crystal can be used to compensate for internal errors. A 10 kHz calibration potentiometer is provided so the 10 kHz fundamental can be adjusted to fall on the top line of the display. With this feature, operation and calibration can be verified for most of the instrument.

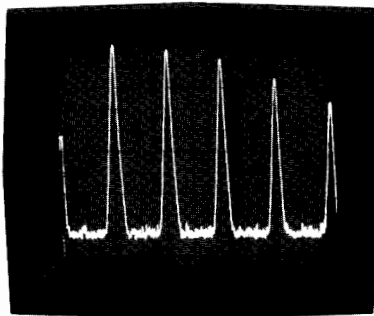

Specifications

Frequency Characteristics

Range: 5 Hz to 50 kHz.

Digital Frequency Display

Resolution: 1 Hz

Accuracy: ± 3.5 Hz, 0 to 55°C.

Typical stability: ± 10 Hz/hr after 1 hour; ± 5 Hz/°C.

Bandwidths:
(accuracy $\pm 15\%$)

1 Hz (25°C \pm 5°C)	3 Hz	10 Hz	30 Hz	100 Hz	300 Hz
10					8

Shape factor:

Out of range blank: if controls are set so portions of displayed signal lie below 0 Hz or above 50 kHz, the baseline is displayed.

Amplitude Characteristics

Overall Instrument Range

Linear: 20 V -100 nV full scale

Log: +30 dBm or dB V;

-150 dBm or dB V

Amplitude Accuracy

Frequency response:

20 Hz–20 kHz

5 Hz–50 kHz

Switching between bandwidths (25°C):

3 Hz–300 Hz

1 Hz–300 Hz

Amplitude display

Input attenuator

Amplitude reference level:

(IF attenuator)

Most sensitive range

All other ranges

Log Linear

± 3 dB $\pm 3\%$

± 5 dB $\pm 5\%$

± 5 dB $\pm 5\%$

± 1 dB $\pm 10\%$

± 2 dB $\pm 2\%$

± 3 dB $\pm 3\%$

± 1 dB $\pm 10\%$

± 1 dB $\pm 3\%$

Dynamic range: 80 dB

IF feedthru: input level > 10 V, -60 dB; < 10 V, -70 dB.

Spurious responses: > 80 dB below input reference level.

Smoothing: 3 positions, rolloff is a function of bandwidth.

Overload indicator: this LED indicator warns of possible input amplifier overloading. Without this indication it would be possible to introduce spurious responses without knowing it.

Sweep Characteristics

Scan width: 50 Hz to 50 kHz.

Log sweep: 20 Hz to 43 kHz $\pm 20\%$ after 3 sweeps.

Sweep times: .1 s to 2000 s.

Rep: repetitive sweeps over the specified band.

Reset: resets to the beginning of the sweep—used to adjust start or center frequency.

Manual: in combination with the concentric knob, manual sweep fully duplicates the span of the electronic sweep.

Adaptive sweep: when in adaptive sweep below the threshold level, scan speed is 20 to 25 times faster. Threshold is adjustable to cover 0–60% of screen. Signals greater than about 6 dB above threshold are detected and swept slowly.

Sweep error light: this LED indicates a sweep that is too fast to capture full response. When the light is on, response can be $> 5\%$ lower than it should.

Zero scan: to look at the time varying signal at the center or start frequency within the bandwidth selected, the zero scan is used.

Output Characteristics

Tracking generator output: (also known as BFO or tracking oscillator output).

Range: 0 to 1 V rms into 600 Ω .

Frequency response: $\pm 3\%$, 5 Hz to 50 kHz.

Impedance: 600 Ω .

Total harmonic and spurious content: 40 dB below 1 volt signal level.

X-Y Recorder Analog Outputs

Vertical: 0 to +5 V $\pm 2.5\%$.

Horizontal: 0 to +5 V $\pm 2.5\%$.

Impedance: 1 k Ω .

Pen lift: contact closure to ground during sweep.

Size: 203.2mm H x 285.8mm W x 412.8mm D (8" x 11 $\frac{1}{4}$ " x 16 $\frac{1}{4}$ ").

Weight: net, 12.25 kg (27 lb); 3580A Opt 001: net, 15.88 kg (35 lb).

Temperature range: 0°C to 55°C.

Power: 100 V, 120 V, 220 V, or 240 V $+5\% - 10\%$. 48 to 440 Hz, 35 VA max.

Opt 001 battery: 5 hours from full charge. 14 hours to fully recharge. The internal battery is protected from deep discharge by an automatic turn off. Useful life of batteries is over 100 cycles.

Ordering Information

3580A Spectrum Analyzer

Opt 001: internal rechargeable battery

Opt 002: balanced input

Opt 003: rack mount



- Transfer function magnitude and phase measurements
- Coherence function measurement
- Phase spectrum measurement
- Transient capture and frequency domain analysis
- Internal periodic and random noise source
- Band selectable analysis for 0.02 Hz resolution
- Alphanumeric CRT annotation and marker readout

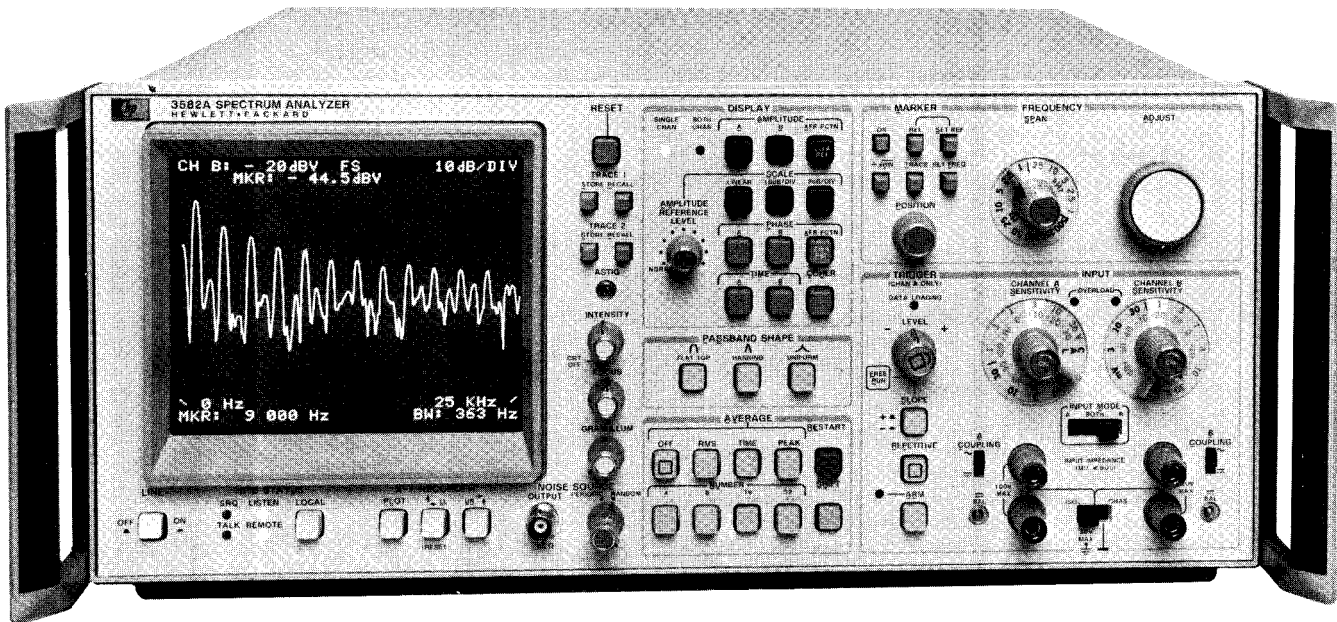

Description

The 3582A is a powerful dual-channel, real-time spectrum analyzer that solves bench or systems measurement problems in the frequency range of 0.02 Hz to 25.599 kHz. Sophisticated LSI digital filtering combined with microcomputer execution of the Fast Fourier Transform (FFT) provides exceptional measurement capability and performance.

Exceptional Frequency Resolution

The ability to resolve closely spaced spectral components is often critical in the study of subtle phenomena such as structural transfer functions. Unlike conventional dynamic signal analysis which extends from DC to some maximum frequency, the Model 3582A can "zoom in" to analyze any selected band of frequencies with dramatically improved resolution. The start or center frequency of the 5 Hz to 25 kHz band analysis spans can be adjusted in 1 Hz increments to cover the entire frequency range of the instrument. This provides resolution down to 20 milliHertz across the entire range for spectrum analysis or 40 milliHertz for transfer functions, representing as much as 5000 to 1 improvement over conventional "baseband" analysis.

Excellent Low Frequency Coverage

Many electrical and physical measurements have significant spectral information in the audio and sub-audio range. With frequency ranges from 25 kHz down to 1 Hz full scale, the Model 3582A is extremely well suited to these types of measurements. The display shown in fig. 1 represents the phase noise of a frequency synthesizer over the range of 0 to 1 Hz with a frequency resolution of 6 milli-Hertz.

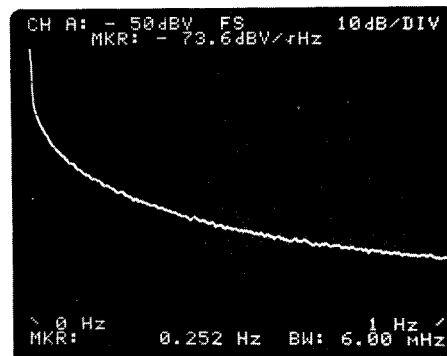

Figure 1: Phase Noise Measurement

Real Time Measurement Speed

Long measurement times can be a major limitation of swept low frequency spectrum analyzers. In high volume testing or in applications requiring substantial on-line tuning these long measurement times are both expensive and inconvenient. Since the Model 3582A uses an advanced microcomputer to execute the Fast Fourier Transform (FFT), it can perform equivalent measurements as much as one to two orders of magnitude faster than a swept analyzer.



SIGNAL ANALYZERS

Dual-Channel, Dynamic Signal Analyzer 0.02 Hz to 25.5 kHz

Model 3582A (cont.)

Wide Amplitude Range

When examining the sensitivity of an analyzer, it is important to consider the full range of potential applications. If the analyzer does not directly cover the range of anticipated signals, external amplifiers or attenuators will be required. These devices can add their own noise and can distort the signal being measured. The Model 3582A offers 150 dB of calibrated measurement range covering +30 dBV (31.6 volts) to -120 dBV (1 μ volt) and thus minimizes the need for external signal conditioning. Even with input sensitivities down to -120 dBV the input circuit is fully protected against accidental overloads of 100 Volts DC or 120 Volts RMS for short periods.

Wide Dynamic Range

In many applications the information of interest is contained not in the high amplitude fundamental, but rather in the low amplitude components. For a spectrum analyzer to provide useful information about these low level components in the presence of a large signal, it must offer wide dynamic range. The Model 3582A dynamic range is specified as 70 dB.

Phase Spectrum Measurement

Most spectrum analyzers can measure only the amplitude spectrum of a signal, yet complete characterization in the frequency domain also requires phase information. Signals with identical amplitude spectra, but different phase spectra can differ significantly. The advanced digital signal processing techniques incorporated in the Model 3582A provide direct measurement of phase spectra.

Transient Capture and Analysis

Many signals such as mechanical shocks and electrical transients may occur infrequently and spontaneously and may last only for a brief period of time. Swept spectrum analyzers generally cannot handle these transient signals. By using digital processing techniques, the Model 3582A can capture and analyze transients as short as a few milliseconds. This means that spectrum analysis and transfer function analysis are no longer limited to stable, time invariant signals.

Transfer Function Measurement with the Internal Noise Source

Many electrical circuits and mechanical systems can be treated as linear networks and can be characterized by the magnitude and phase of their transfer functions.

Most spectrum analyzers can measure only the magnitude portion of the transfer function—and even then only by assuming a flat drive signal. The Model 3582A directly measures the complete transfer function, both magnitude and phase. With dual channels the actual drive signal is measured on Channel A and thus does not have to be totally flat; drive signal variations are taken out in the computation process to give valid results. The major constraint on the input signal is that, unlike a swept source, it must stimulate all frequencies of interest simultaneously. Two sources are provided in the Model 3582A which meet this constraint. They are pseudo-random and random noise. For linear networks, the pseudo-random noise source gives you accurate results in the fastest theoretically possible time. When non-

Figure 2: Capture and analyze transients.

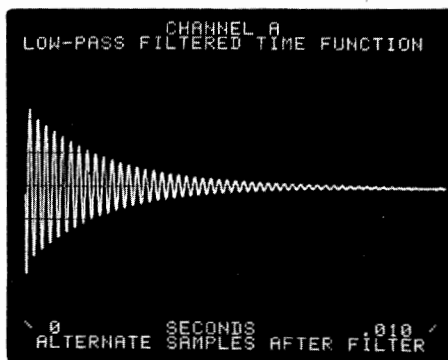

linearities are a problem, random noise gives the best estimate of the transfer function at the operating point. In addition, both noise sources are bandlimited to concentrate all stimulus energy in the band of frequencies analyzed. This minimizes test time because it improves the signal to noise ratio of the measurements. This also minimizes the disturbance to the network under test, which can be very important in control applications.

With this drive signal functioning as a "tracking generator" substitute, the Model 3582A is a low frequency network analyzer with "real-time" measurement speed. As with spectrum measurements, portions of the transfer function as narrow as 5 Hz can be examined anywhere over the 25 kHz frequency range.

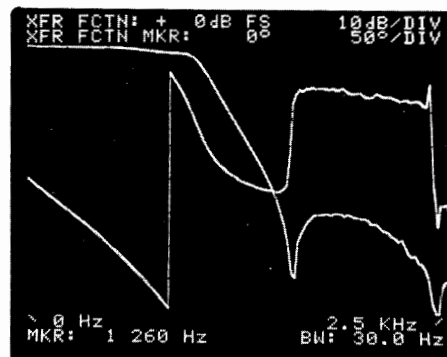

Figure 3: Filter Transfer Function

Coherence Function Measurement

The measurement of a device transfer function assumes that the device under test is linear and that no portion of the output is caused by noise or extraneous signal sources. In active electronic circuits or mechanical structures these conditions can easily be violated - yet such violations are very difficult to identify. The Model 3582A considerably simplifies this problem by providing the direct measurement of the coherence function. This is a frequency domain measure of the fraction of the power in one signal (e.g., the output) caused by the other measured signal (e.g., the input). If this fraction is 1.0, the output at that frequency is caused by the input and the transfer function is valid. If the fraction is near 0.0, the output is caused by something other than the measured input. This cause could be noise, nonlinearities or an unanticipated input, but the result is the same - the transfer function data at that frequency is suspect.

In addition to serving as a valuable check on the validity of transfer functions, the coherence function can be useful when investigating cause/effect relationships particularly in multiple input systems.

Powerful Marker Operations

The intensified dot marker is a major operational convenience. When active, the frequency and corresponding amplitude, phase or coherence value of the dot, are displayed alphanumerically on the display. Since the results are calibrated, there is no need to go through the time consuming, error-prone process of visually interpreting display points.

For operations such as determining frequency and amplitude separation, the marker can read out in units relative to a previous marker setting which was defined as a reference point.

When making band analysis measurements, the marker can be used in place of the frequency adjust control to define a new start or center analysis frequency.

Digital Averaging Capability

Many spectral measurements contain both discrete signals and random noise components. Obtaining proper amplitude readings can be difficult if the random components are really the ones of interest or are of nearly the same amplitude as the discrete signals.

The digital averaging techniques incorporated in the Model 3582A help solve these problems. The RMS averaging mode takes the power average of 4 to 256 successive spectra in order to reduce the uncertainty of the estimate of random spectral components. For measurements where the spectral information is not stable but varies slowly with time, a running exponential form of RMS averaging is provided. By continually reducing the importance of older spectra, this mode prevents old data from completely obscuring new data yet still retains the basic advantages of averaging.

When a synchronizing trigger signal is available, the TIME average can enhance the signal-to-noise ratio by as much as 24 dB. Since it involves the averaging of successive time records before transformation it is also significantly faster than other types of averaging.

Powerful HP-IB Capability

The Hewlett-Packard Interface Bus (HP-IB) is an interface concept that allows two-way communication among as many as fifteen different devices. Generally, at least one of these devices is a "computing controller" which exercises overall system control. This controller directs and coordinates the activities of the other devices in the system.

All major front panel controls with the exception of the verniers are fully programmable via the HP-IB. The programming codes are simple and are logically derived from the front panel control labels. The states of the various controls occupy only ten 8-bit bytes of data that can be read and written by the HP-IB. This allows you to manually set up a test from the front panel and store it in a compact form.

From the HP-IB it is a simple matter to command the Model 3582A to output results in a usable form. Not only can the various control settings be retrieved, but numeric marker data can be extracted. More importantly, the full display can be read in ASCII format along with complete annotation.

The HP-IB structure is entirely flexible, allowing any of the RAM (random access memory) in the instrument to be read or written into. This means that intermediate computational results such as the cross power spectrum can be read by a computing controller. In applications where speed is critical, the controller can transfer the displayed traces in binary, direct from the RAM.

3582A Specifications

Frequency

Range: 0.02 Hz to 25.5 kHz with the low frequency limit the result of dc response.

Spans: 1 Hz to 25 kHz in a 1-2.5-5-10 sequence. The 1 Hz and 2.5 Hz spans are usable only in the 0-start mode.

Accuracy: $\pm 0.003\%$ of display center frequency.

Resolution: 0.4% of the frequency span for single channel or 0.8% of the frequency span for dual channels.

Filter Passband Shape

	Flat Top	Hanning	Uniform
3 dB Bandwidth (single channel)	$1.4 \pm 0.1\%$ of span)	$(0.58 \pm 0.05\%$ of span)	$(0.35 \pm 0.02\%$ of span)
Shape Factor	2.6 ± 0.1	9.1 ± 0.2	716 ± 20

Amplitude

Display Modes

Log: 10 dB/division or 2 dB/division

Linear: constant voltage/division

Measurement Range

Log: +30 dBV to -120 dBV noise floor

Linear: +30 V to $1\mu\text{V}$ noise floor

Dynamic range: 70 dB

DC response: adjustable to >40 dB below maximum input level

Accuracy

Accuracy at the Passband Center ± 0.5 dB

Flat top filter: +0, -0.1 dB

Hanning filter: +0, -1.5 dB

Uniform filter: +0, -4.0 dB

Note: overall accuracy is the sum of the accuracy at the passband center plus the selected filter accuracy.

Resolution

Log: 0.1 dB

Linear: 3 digits

Phase

Display range: +200 degrees to -200 degrees

Accuracy: ± 10 degrees

Resolution: 1 degree

Transfer Function

Measurement Range

Log: +160 dB full scale to -80 dB full scale

Linear: 4×10^8 full scale to 4×10^{-8} full scale

Phase display range: +200 degrees to -200 degrees

Accuracy

Amplitude ϕ	0.4 dB	0.8 dB
	$\pm 2^\circ$	$\pm 5^\circ$

.02 Hz 5 kHz 25.5 kHz

Coherence

Measurement range: 0.0 bottom display line to 1.0 top display line

Resolution: 0.01

Input

Impedance: $10^\circ \Omega \pm 5\%$ shunted by <60 pF from input high to low (for less than 75% relative humidity)

Isolation: input low may be floated up to 30V

Coupling: switch selection of ac or dc coupling. The low frequency 3 dB roll off is <1 Hz.

Common Mode Rejection

50 Hz: >60 dB

60 Hz: >58 dB

Crosstalk: <-140 dB between channels with 1 k Ω source impedance driving one channel and the other terminated in 1 k Ω .

Output

X-Y Recorder

Level: 0V to 5.25 V $\pm 5\%$

Impedance: 1 k Ω

Pen lift: contact closure during sweep

Noise Source

Type: periodic pseudorandom noise or random noise signal with switch selection. Both are band limited and band translated to match the analysis.

Level: From <10 mV to >500 mV RMS into $>50 \Omega$

Impedance: $<2 \Omega$

General

Environmental

Temperature: 0°C to 55°C operating; -40°C to +75°C storage

Humidity: $<95\%$ R.H. 0°C to 40°C

Power requirements: 100, 120, 220, or 240 volts (+5%, -10%); 48-66 Hz; less than 150 VA

Dimensions

Size: 425.5 W x 552.5 D x 188 mmH (16.75" x 21.75" x 7.4")

Weight: 24.5 kg (54 lbs.). Shipping weight: 29 kg (63 lbs.)

3582A Spectrum Analyzer

SIGNAL ANALYZERS

Automated Spectrum Analysis

Model 3047A Spectrum Analyzer System

Calibrated, Automatic Measurement of

- Phase noise
- Amplitude noise
- Spurious signals
- Close-in sidebands



The HP 3047A Spectrum Analyzer System combines the speed and millihertz resolution of Fast Fourier Transform (FFT) Spectrum Analysis with the frequency range of Swept Spectrum Analysis. This unique measurement combination is joined with the powerful computational and control capabilities of a desktop computer to give a wide variety of calibrated spectrum analyzer measurements, including phase noise.

Phase Noise Measurements

When used with the 3047A, the term phase noise includes all forms of frequency and phase instability. Frequency and phase noise as well as undesired modulation like power-line phase modulation and phase jitter are included in the term and can be measured by the 3047A Spectrum Analyzer System.

The complexity of phase noise measurements increases with increasing source performance. For relatively noisy sources, the noise can be measured directly on an existing spectrum analyzer. However, for many sources this measurement is not sensitive enough. If the spectrum analyzer is preceded by a frequency discriminator or phase detector, the system sensitivity can be increased at the cost of additional measurement hardware. The Phase Noise Measurement Mode of the 3047A is designed to reduce the difficulty of making accurate phase noise measurements with either the frequency discriminator or quadrature phase detector techniques.

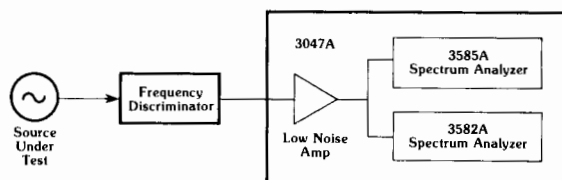

Frequency Discriminator Method

Frequency Discriminator

With the 3047A, fully calibrated measurements are possible with user-supplied frequency discriminators. The 3047A software gives instructions for setting up an input signal of known characteristics, and then calibrates the system (plus discriminator) as a whole. Overall accuracy is an excellent ± 2 dB. Although this approach does not optimize sensitivity or bandwidth, it is simple, which makes it quite attractive for a number of applications.

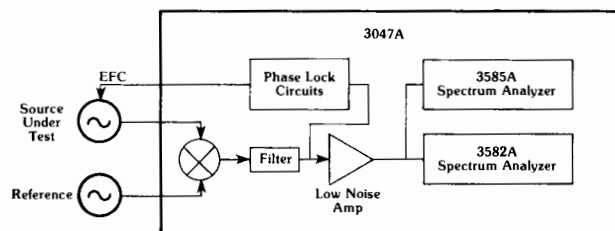

Phase Detector Method

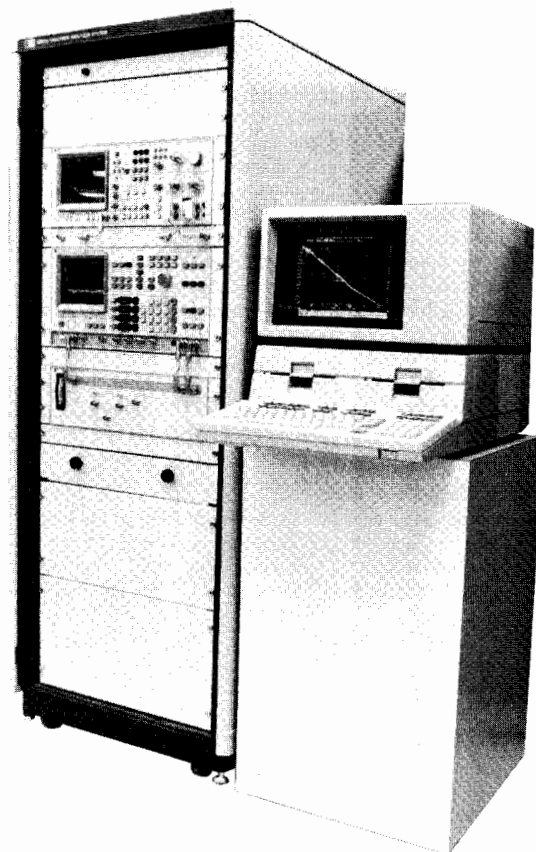

9836A-based 3047A system

Quadrature Phase Detector

This phase detection scheme offers the dual benefits of high sensitivity and broad band operation. Until now, these benefits were difficult to realize, due to the need to set up and characterize a phase locked loop. Thanks to the power of the 9836A (or 9845B) desktop computer, these procedures are now fully automated. After the user has connected his unknown and reference sources to the 3047A, system software establishes the phase locked loop, fully characterizes it and performs all the calculations involved in producing a fully calibrated measurement. Accuracy is again ± 2 db.

Phase Noise Measurement Mode—Abbreviated Specifications

Phase Detector Inputs

Carrier Frequency Range: 5 MHz to 18 GHz in two ranges

	Frequency Range	Return Loss	Isolation
Low Frequency Inputs:	5 MHz to 1.6 GHz	5 dB (3.5 VSWR)	15 dB
High Frequency Inputs: (may be deleted with Option 110)	1.2 GHz to 18 GHz	5 dB (3.5 VSWR)	15 dB

(The frequency range can be extended with a customer supplied mixer or frequency discriminator)

**Typical 3047A
Phase Noise
Measurement**

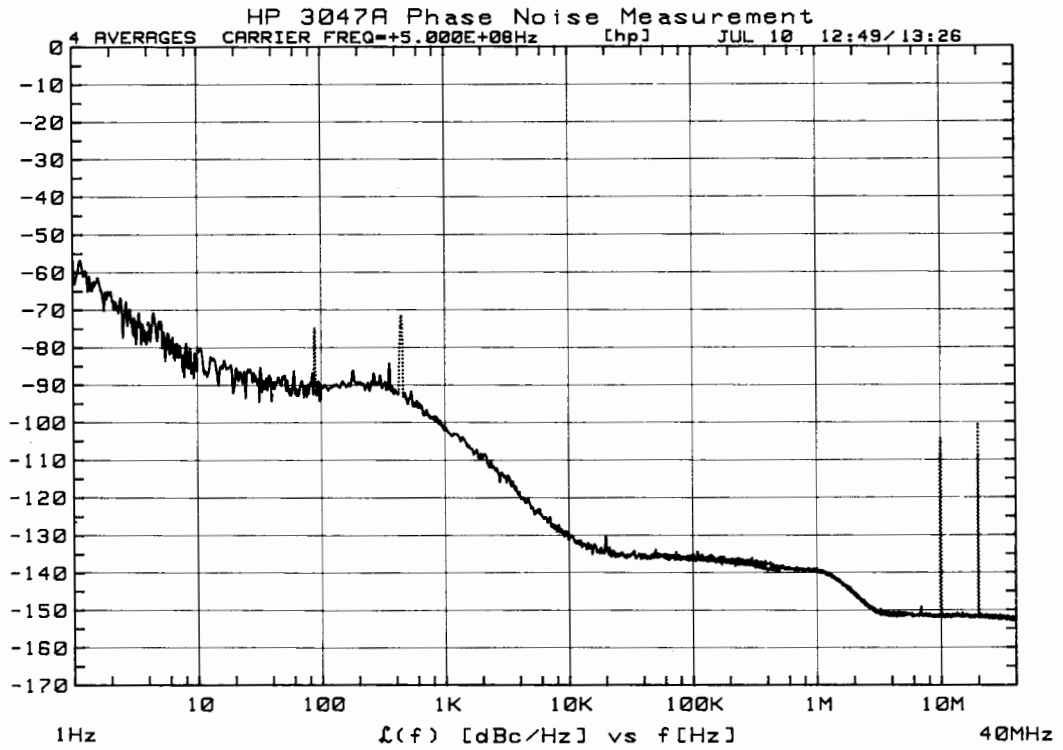

Amplitude

	5 MHz-1.6 GHz		1.2 GHz-18 GHz	
	L input	R input	L input	R input
Maximum Signal Level (dBm)	+23	+23	+10	+10
Minimum Signal	+15	-5	+7	+0

Signal Input Port (for use with external phase detector or frequency discriminator)

Frequency Range: 0.02 Hz to 40.1 MHz
 Input Impedance: 50 Ω , Return Loss 9.5 db (2:1 VSWR)
 Max Amplitude: 1 volt peak
 Spurious Signals: < -100 dBm

Accuracy

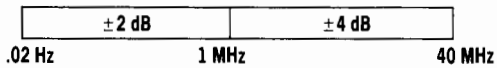

Noise and Spurious Degradation with Input Signal Level

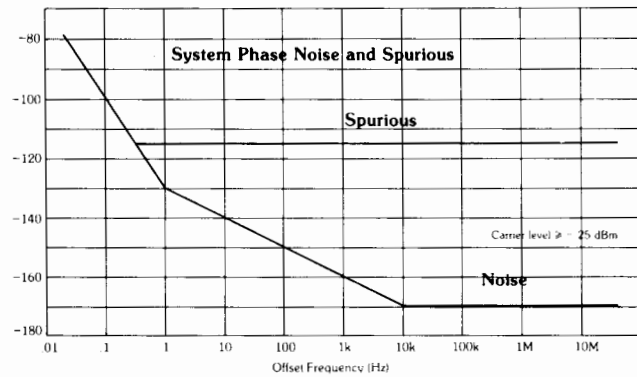
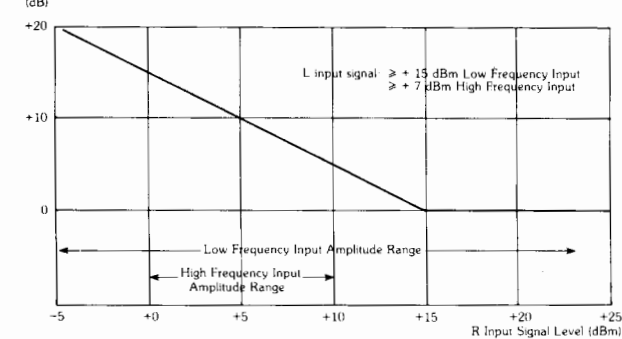

Accuracy: External phase detector measurements or frequency discriminator measurements calibrated with ± 1 dB accurate signals

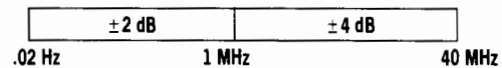

SIGNAL ANALYZERS

Automated Spectrum Analysis

Model 3047A Spectrum Analyzer System (cont.)

Direct Spectrum Mode

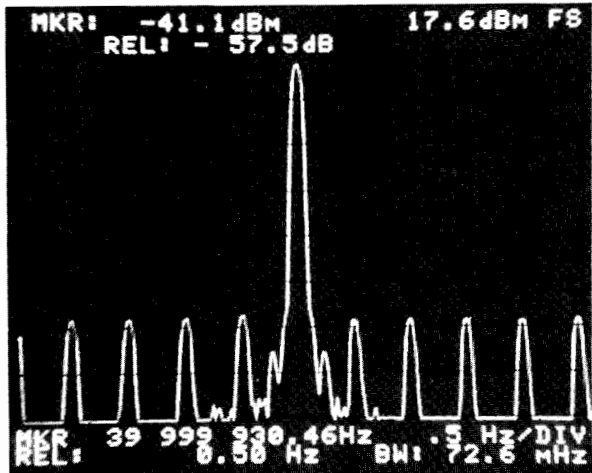

Direct spectrum measurement with 0.072 Hz bandwidth

In the Direct Spectrum Mode the system hardware is used as a down converter to bring 19 kHz to 40 MHz signals into the frequency range of the 3582A Real Time Spectrum Analyzer. This allows the very high resolution and measurement speed of the Real Time Spectrum Analyzer to be used up to 40 MHz. In this mode the system is capable of resolution bandwidths as narrow as 0.02 Hz and is one to two orders of magnitude faster than a swept spectrum analyzer. The system provides these measurements over the wide dynamic range of 70 dB, calibrated in both frequency and amplitude.

Noise Sideband Mode

While the 3047A can measure very high quality sources in the Phase Noise Mode, moderate performance sources can be measured more easily in the Noise Sideband Mode. In this mode the system measures both AM and PM noise without additional hardware. The system software connects the 3047A input to the 3585A and the output of the analyzer is fed into an internal phase detector. The output of the detector is connected to the 3582A Analyzer and the phase noise measured over the .02 Hz to 25 kHz range. In addition, a second detector is provided which outputs the AM noise of the signal to the second channel of the 3582A Analyzer.

Sources with noise greater than the 3585A Spectrum Analyzer's local oscillators are very easy to measure with 3047A in this mode. The source under test is just connected to the 3047A and the measurement is run. There is no need for a high quality reference or for a frequency discriminator.

Ordering Information

3047S Spectrum Analyzer System

By ordering the system instrumentation, software and controller under this model number, total system compatibility is insured.

3047A System Instrumentation

Includes 3582A and 3585A Spectrum Analyzers, 35601A Spectrum Analyzer Interface and system rack with all associated power and signal cabling.

(Specify one software option)

136: Software for 9836A-based systems

145: Software for 9845B opt. 175-based systems

175: Software for 9845B opt. 275-based systems

(Specify one power line option)

300: 100 VAC operation

320: 120 VAC operation

330: 220 VAC operation

340: 240 VAC operation

9836A Controller configurations are priced beginning
9845B Controller configurations are priced beginning
3047A+24A System Training (required with each system)

Full details on available system options and recommended controller configurations are given in the 3047S System Configuration Guide.

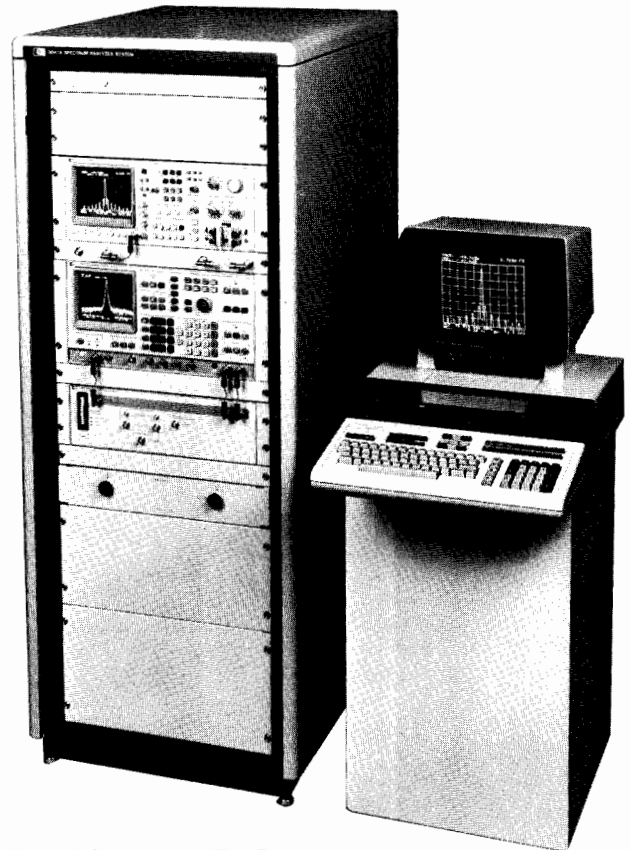

9845B-based 3047A System

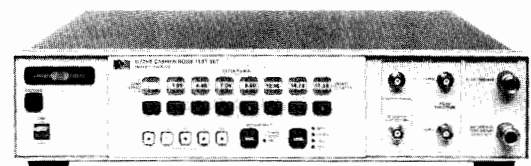

11729B Carrier Noise Test Set



The most sensitive methods for measuring phase noise require two signal sources; the device under test and a reference source. This reference must be of the same frequency as the unknown, and must be of equal or better noise performance. As the state-of-the-art in low noise microwave sources advances, the problem of finding a suitable reference becomes acute.

The 11729B Carrier Noise Test Set solves this problem for a great many applications. When driven with a low noise signal source such as the HP 8662A Synthesized Signal Generator, it can provide tuneable reference signals from 5 MHz to 18 GHz. Phase noise is typically as low as -123 dBc/Hz at 1 kHz offset from a 10 GHz carrier.

In addition to providing low noise reference signals for complete systems such as the 3047A, the 11729B and 8662A can also form the basis for smaller, custom-built systems. With built-in capabilities for phase locking, output signal conditioning and loop bandwidth selection, the instrument can provide phase noise output spectra suitable for display on low frequency spectrum analyzers such as the 3582A.

For more information on the 11729B, see page 361.

SIGNAL ANALYZERS

Digital Signal Analyzers

Models 5420B and 5423A

523



- Dual-channel transfer function
- Band-selectable analysis
- Fully calibrated annotated display

- Powerful post-measurement processing
- Digital data storage
- Band limited random noise generator with burst mode

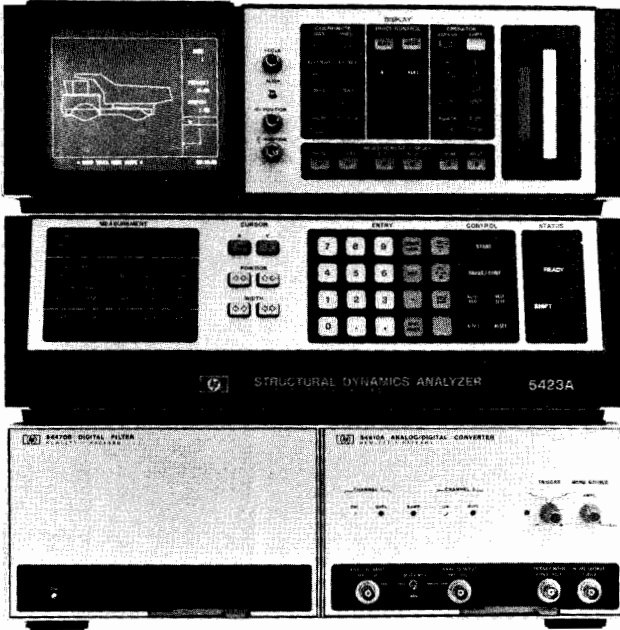

5423A



The 5420B Digital Signal Analyzer and 5423A Structural Dynamics Analyzer are high performance dual-channel instruments capable of a number of both time domain and frequency domain measurements over a 25 kHz range. In addition to broad measurement capability, the 5423A Structural Dynamics Analyzer provides complete facilities for analyzing the vibration characteristics of mechanical devices and displaying the results in the form of an animated mode shape. Both instruments are particularly adapted to solving problems associated with structural vibration and noise, rotating machinery, electro-mechanical control systems, acoustics and a host of similar applications which call for advanced low-frequency analysis.

Among the important standard features are a fully annotated and calibrated dual-trace display, permanent digital storage for measurement results, band selectable analysis, extensive data processing, advanced triggering capability, external sampling capability, calibration in engineering units and a built-in band-limited random noise generator with a new burst random mode. Capable of both stimulus-response and response only analysis, their measurement repertoire includes:

- Transfer Function
- Coherence Function
- Impulse Response
- Auto Spectrum
- Cross Spectrum
- Linear Spectrum
- Time Record
- Amplitude Histogram
- Auto Correlation
- Cross Correlation

Important capabilities such as independent pre and post trigger delay on each input channel, overlap processing, and external sampling insure that each instrument's measurement power can be effectively applied to a wide range of problems.

A built-in "waveform calculator" is useful for processing measured or synthesized data and greatly extends the basic capabilities. Examples of useful computed functions include:

- Data Comparisons
- Resonant Frequency
- % Critical Damping
- Open Loop Gain
- Calibration in %
- Mechanical Impedance
- Total Harmonic Distortion
- Coherent Output Power
- Signal-to-Noise Ratio
- Transmissibility
- Function Synthesis
- Power



Operation

Operation of a digital signal analyzer has never been easier. A novel "menu" concept replaces the rotary and toggle switches commonly used to control an instrument's operation. The entire current set-up state, including measurement type, bandwidth, input ranges, etc., is displayed on the CRT at the push of a key. Changes to the set-up are made by selection from displayed lists (menus) or by direct numerical input from the control keyboard.

Once set-up, measurements are easily executed and may be paused or continued at will. Results are always fully calibrated and annotated. A self-test feature verifies proper operation.

Data Display

Both the 5420B and the 5423A feature a fully annotated and calibrated, dual trace, three-format display which provides for ease of data interpretation. Each display trace is totally independent of the other in terms of the data which the user selects for display, the horizontal and vertical ranges over which it is displayed, and the coordinate system chosen. The user may select from up to 13 available coordinate systems, including complex plots such as Nyquist, at the push of a key. Display traces may be viewed one at a time in full format or simultaneously in either an upper/lower or overlaid format.

Dual X and Y axis cursors provide numerical data readout, in either absolute or relative terms, on both axes simultaneously in full format. Any area of the display may be graphically expanded for optimum viewing. Cursors may be either swept or set explicitly, via numerical entry, to desired locations. Harmonic cursors are provided. The X axis cursors may also be used to set the frequency range over which the instrument will operate, thereby concentrating its resolution into the bandwidth of interest.

The display section also contains a digital recorder which provides permanent storage of measurement results on small removable tape cartridges and eliminates the need to repeat time consuming and expensive testing. Stored measurements may be easily recalled for display, plotting, or further processing.

SETUP STATE

```

MEASUREMENT : TRANSFER FUNCTION
AVERAGE :      25      , STABLE
SIGNAL :      RANDOM
TRIGGER :      FREE RUN , CHNL 1

CENT FREQ :      2.0000 KHZ
BANDWIDTH :      800.000 HZ
TIME LENGTH :      320.000 mS
      ΔF :      3.12500 HZ      ΔT :      025.000 μS

ADC CHNL  RANGE  AC/DC      DELAY      CAL (C1/C2)
  * 1      5 V   AC          0.0 S      33.3333
  * 2     10 V  DC          10.0000 S  20.0000
    
```

SIGNAL ANALYZERS

Digital Signal Analyzers (cont.)

Models 5420B and 5423A

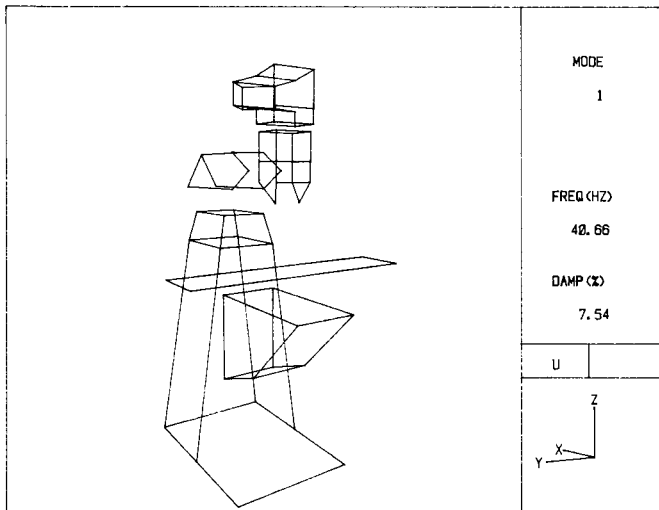
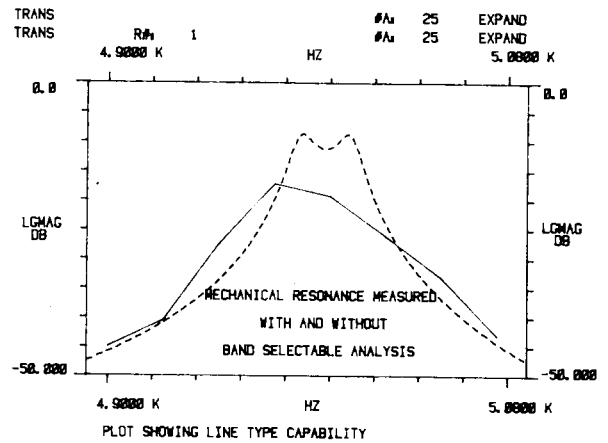
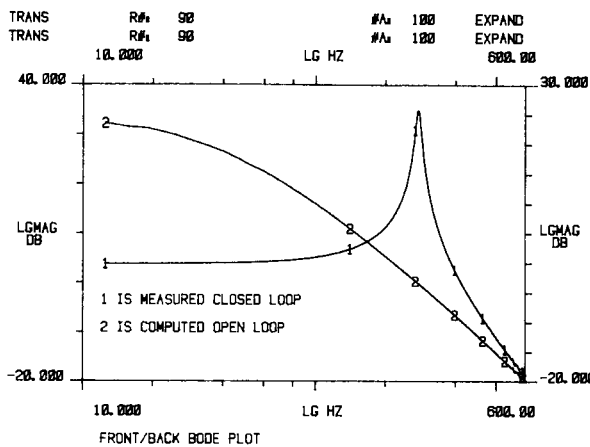
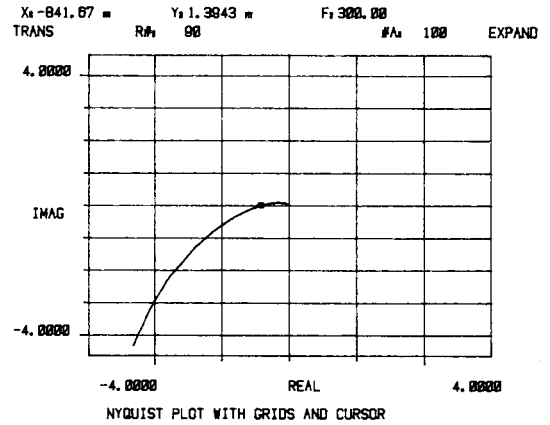
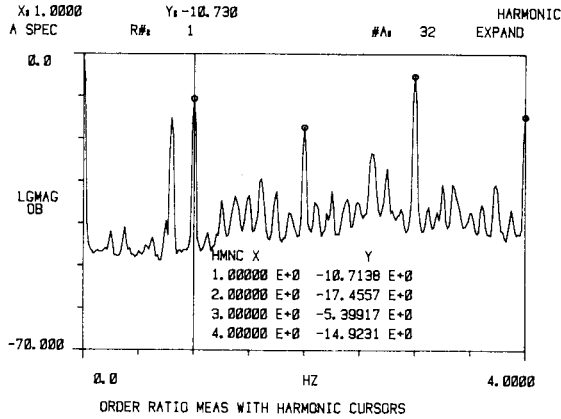

MODE SHAPE

MODE NO.	FREQ (HZ)	DAMP (%)	M. MASS	M. DAMP	M. STIF	LB-SEC ² /IN	LB-SEC/IN	LB/IN
1	40.660	7.537	10.136 μ	391.538 μ	665.487 m			

DOF#	PT	DIR	AMPLITUDE
1	1	X	-15.4868 μ
2	1	Y	39.9408 μ
3	1	Z	-563.770 μ
4	2	X	10.2221 μ
5	2	Y	26.5220 μ
6	2	Z	-640.359 μ
7	3	X	19.2426 μ
8	3	Y	-9.6004 μ
9	3	Z	-479.791 μ
10	4	X	9.1779 μ

TOTAL DEGREES OF FREEDOM: 348

Dynamic Analysis

The 5423A provides, for the first time in a transportable, easy to use, low cost instrument, complete dynamic analysis capability. Frequency response measurements are made at points of interest on the test structure. The 5423A then analyzes the raw data to determine the frequency and damping associated with the structure's natural modes of vibration. In addition, the deflection pattern or mode shape of the structure is calculated for each mode of vibration. Results are available in tabular form or as an animated display with perspective to ease interpretation.

Mode shape display features include the ability to view the structure from any desired direction and distance. Amplitude and speed of animation are easily controlled and the structure can be made to rotate about any desired axis. A split-screen format facilitates compar-

son of different modes of vibration and may also be used to observe the structure in three dimensions with stereo viewers.

HP-IB*

Both the 5420B and 5423A include an HP-IB interface to provide for instrument control and data transfer to and from external computing controllers. In addition, both instruments are directly compatible with the HP 9872 and 7470 Digital Plotters. A separate computing controller, with its attendant cost and programming requirements, is not needed. The user merely presses the plot or print key and the instrument will reproduce the desired information in hard copy form on the plotter.

Ordering Information

5420B Digital Signal Analyzer

5423A Structural Dynamics Analyzer

*HP-IB cables not supplied, see page 37 for description and prices

SIGNAL ANALYZERS

Digital Vibration Test Control System

Model 5427A

525



- Random test flexibility for use with MIL, IEC, and other standards
- Automatic out-of-tolerance detection protects device under test

- Economical expansion for sine and transient control
- Ultra-high random control resolution: 512 lines standard (1024 lines optional)

Description

Closed-loop control of environmental and/or developmental vibration test stimuli for random, transient, and sine testing is available in the 5427A.

The basic 5427A Vibration Test Control system consists of: 2-channel (expandable to 4) analog-to-digital converter for processing feedback information; 21MX-E series, microcoded digital processor; 1335A Persistence CRT display; 2648A Graphics Terminal; push-button control unit; 9885M Flexible Disc storage unit; cabinet and programs for random control.

The 5427A is the ideal vibration control system for production vibration testing where random, transient and sine testing are required and offers a selectable set of analysis routines especially designed for easy operation by laboratory personnel. The following vibration test control capabilities apply to the 5427A.

System Operation

Random, sine and transient control follow the same logical operational phases. First, the appropriate disc is loaded and the test program or setup (envelope, alarm and abort limits, test time, calibrations, etc.) is loaded from disc storage in response to search codes or names. If a new program or modifications are desired, a friendly question-and-answer sequence is used. Once a new setup has been generated or changes made, it can be assigned a new name and stored for later use.

After a satisfactory setup is obtained, the operate phase allows control of the actual test via pushbuttons on the central control panel. Removable snap-on overlay panels clearly label buttons for the type of test desired. Choices of on-line displays and a 'save' button allow saving of data for later plotting, including auxiliary PSD measurements during random control.

After the test, results and all saved data are available for review or documentation. The graphics terminal or an optional HP-IB compatible digital plotter provide fully labeled, report-quality plots of test results. In random control, fully labeled plots can be obtained while the test is running (open loop) using the terminal or an optional HP-IB plotter such as the HP-7470A.



5427A

Sweep time accuracy: $\pm .25\%$ or ± 52 ms, whichever is greater

Amplitude accuracy: the greater of ± 2.5 mV or $\pm 1\%$ of specified reference value.

Output dynamic range: 72 dB

Transient Control

Classical reference waveforms: half-sine, terminal peak sawtooth, triangle or rectangle

Polarity: positive or negative

Duration range: 0.5 to 100 ms

Duration accuracy: $\pm 5\%$ for half-sine and terminal peak sawtooth at pulse baseline crossover points

Shock response spectrum synthesis: time domain waveforms are synthesized from a user-specified shock response spectrum (SRS) off-line in the setup mode

Resolution: $1/N$ octave, N is any integer from 1 to 9

Frequency range: 2 decades nominal, 2.6 decades maximum

Maximum frequency: $1/N$ th octave below 10,240 Hz

Ordering Information

5427A Vibration Test Control System

Option 070 High resolution random (1024 lines)

Option 075 Transient control

Option 080 Sine control

Specification Summary

Random Control

Resolution: 64, 128, 256, or 512 lines (1024 lines optional)

Bandwidth: Δf to 5000 Hz

Loop time: < 0.9 s for 256 lines, 2500 Hz bandwidth, one control channel and full display

Dynamic range: > 65 dB

Accuracy

rms PSD accuracy: $\pm 2\%$

Control PSD accuracy: ± 1.0 dB (90% confidence level) Higher accuracies are typically achievable with increased control spectrum averaging.

Sine Control

Frequency range: 0.1 to 5000 Hz. Upper and Lower sweep frequency limits and starting frequency may be specified anywhere in the frequency range (resolution: 0.1 Hz).

Sweep rate: 0.001 to 100 octaves/minute log, 1 to 100,000 Hz/minute linear, operator selectable.

Harmonic components: > 60 dB below full level fundamental output



SIGNAL ANALYZERS

Frequency Stability Analyzer

Model 5390A

- Phase noise measurements close to carrier
- Offsets from 0.01 Hz to 10 kHz
- Sensitivity as high as -140 dBc at 1 Hz offset
- Measures sources to 18 GHz
- Automatic operation
- Measurements in both frequency and time domains



5390A System shown with 7470A plotter

General

The 5390A Frequency Stability Analyzer will characterize oscillator stability in either the time domain or the frequency domain. For time domain characterization, the 5390A measures fractional frequency deviation which represents the RMS deviation of the signal from the nominal carrier frequency measured over a given time interval. For characterization in the frequency domain, the 5390A presents results in terms of the spectral density of phase fluctuations. The 5390A specializes in high resolution phase noise measurements close to the carrier where other techniques are difficult to use or are unable to make the measurements at all.

The system can accommodate a wide frequency range of input signals from 500 kHz to 18 GHz. Provision is also made for external mixers for broader frequency coverage or direct input in the range of DC-100 kHz. With this amount of flexibility, almost any oscillator can be measured with the 5390A. All the signal processing capabilities needed to make measurements are built into the system, including down-conversion, low-noise amplification, and bandwidth control.

The 5390A is a complete hardware and software measurement system, fully assembled and tested at the factory. Making measurements only requires connecting the test and reference oscillators and specifying a few measurement parameters. Thereafter, the system runs unattended to the completion of the specified group of measurements. Access to the interactive application programs is provided through specially defined keys on the computing controller's keyboard.

Measurement Technique

The basic system configuration uses a heterodyne down-conversion technique to produce a measurable signal. Two oscillators, the test oscillator at a carrier frequency ν_0 and a reference oscillator at a frequency $\nu_0 \pm \nu_b$, are connected to a double balanced mixer through one of the sets of inputs on the 10830A Mixer/IF Amplifier. (Usually two identical oscillators, one slightly offset, are used. In this case, the noise measured is twice the contribution of either oscillator. The 5390A's software can compensate for this factor of two to produce the correct result). The resultant difference frequency (or "beat" frequency), ν_b , is filtered and amplified by a low noise limiting amplifier and applied to the input of the 5345A Electronic Counter. The 5345A makes frequency measurements of the beat frequency under the control of the 5358A Measurement/Storage Plug-in at measurement intervals also determined by the 5358A. The measurement results are stored locally in the 5358A facilitating the taking of a large number of measurements very rapidly and reducing "dead time" between measurements to less than $17 \mu\text{s}$.

Option 010 Dual Mixer Time Difference

Measurements can be made with the 5390A using either the standard single heterodyne configuration or the dual mixer time difference configuration (Option 010). The primary application of the single heterodyne method is where an offsettable reference oscillator is available, whose noise over the range of interest is equal to or better than the test oscillator. The primary application of the Option 010 configuration is for measuring non-offsettable sources.

In the Dual Mixer Time Difference configuration of the system (Option 010) a second 10830A Mixer-IF Amplifier is added. A third difference oscillator is used in this set-up to produce two measurable signals. The test oscillator at a frequency ν_0 and the reference oscillator at essentially the same frequency are each applied to the 10830A's. The difference oscillator's signal ($\nu_0 + \nu_b$) is split and applied to both 10830A's. The resultant two difference signals (ν_b) are applied to the 5345A's inputs and time interval measurements are made between the two at intervals τ .

System Options

001 Expands 5358A memory in 2K increments. Up to three Opt. 001's may be added.

004 Adds 59309A Digital Clock and HP-IB cable.

010 Adds second 10830A, 59308A, power splitter, system cabinet, and expands 5358A memory to 6 Kbytes.

325 Deletes 9825B and 98034B

373 Deletes 2673A Printer

Accessories Available

7470A Plotter

Ordering Information

5390A Basic System includes:

5345A Option 011 Electronic Counter

5358A Measurement Storage Plug-in

10830A Mixer/IF Amplifier

10831A Test Tone Generator

9825B Computing Controller

98034B HP-IB Interface

2673A Printer

System Cabinet

System Software

5390A Basic System

THE LAST DATE THAT ORDERS WILL BE ACCEPTED FOR THE 5390A SYSTEM IS NOVEMBER 30, 1983

SIGNAL ANALYZERS

Distortion Measurement Set

Model 339A



- Ultra low distortion measurements
- Built-in low distortion oscillator
- Automatic
- True RMS detection

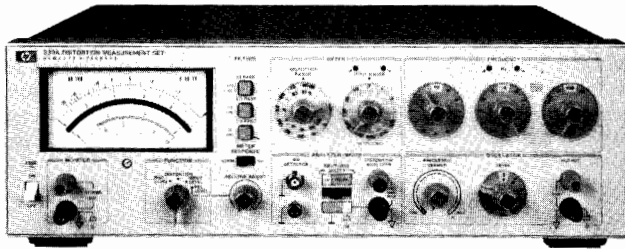

339A

Description

Hewlett-Packard's Model 339A Distortion Measurement Set is an ultra low distortion measuring system complete with total harmonic distortion (THD) analyzer, true-rms voltmeter, and sinewave oscillator. This small, lightweight bench measurement set allows you to make THD distortion measurements as low as 0.0018% over a 10 Hz to 110 kHz frequency band including harmonics to 330 kHz.

For fast and easy THD measurements the built-in tracking oscillator in HP's 339A saves test time because you tune one instrument instead of two. Frequency and level measurements are easy to do with HP's 339A's voltmeter, which offers you a 1 mV to 300 V measurement range. The Relative Level mode has been included to further simplify frequency response measurements. Just set a 0 dBm reference at any frequency from 10 Hz to 110 kHz. Gain measurements can be read directly from the easy-to-read meter.

Operation Simplicity

Automatic frequency tuning and set-level features allow you to make rapid, error free THD measurements. The 339A's built-in tracking oscillator eliminates the need to find the fundamental frequency and tune the analyzer for a null. Just select your oscillator frequency and the rest is automatic. Automatic set-level saves time by automatically setting 0 dB (100%) reference in the distortion measuring mode. Front panel directional indicators light when the input range setting is improper insuring accurate and repeatable measurements. Automatic set-level also greatly simplifies measurements where distortion as a function of level (SINAD¹, for example) is desired. Without this feature, measurements are very time consuming and tedious.

When an external stimulus is used, analyzer tuning is simplified by directional indicator lights for reaching the fundamental null quickly and easily.

Specifications

Distortion

Fundamental frequency range: 10 Hz to 110 kHz continuous frequency coverage in 4 decade ranges with 2-digit resolution. Distortion analyzer and oscillator are simultaneously tuned.

Distortion measurement range: 0.01% full scale to 100% full scale (-80 dB to 0 dB) in 9 ranges.

Detection and meter indication: true rms detection for waveforms with crest factor ≤ 3 . Meter reads dB and % THD (Total Harmonic Distortion). Meter response can be changed from NORMAL to VU ballistics with a front panel switch.

Distortion Measurement Accuracy

20 Hz to 20 kHz	± 1 dB
10 Hz to 50 kHz	+ 1, -2 dB
50 kHz to 110 kHz	+ 1.5, -4 dB

Note: the above specifications apply for harmonics ≤ 330 kHz.

Fundamental Rejection (3 V scale or above)

10 Hz to 20 kHz:	> 100 dB
20 kHz to 50 kHz:	> 90 dB
50 kHz to 110 kHz:	> 86 dB

Distortion Introduced by Instrument (input > 1V rms)

10 Hz to 20 kHz:	< -95 dB (0.0018%) THD
20 kHz to 30 kHz:	< -90 dB (0.0056%) THD
30 kHz to 50 kHz:	< -85 dB (0.01%) THD
50 kHz to 110 kHz:	< -70 dB (0.032%) THD

Residual noise (fundamental frequency settings < 20 kHz, 80 kHz filter IN, source resistance ≤ 1 K Ω shielded): < -92 dB referenced to 1V.

Input level for distortion measurements: 30 mV to 300 V rms (100 mV range minimum).

Input impedance: 100 k Ω \pm 1% shunted by < 100 pF input High to Low.

Monitor: provides scaled presentation of input signal after fundamental is removed for further analysis using oscilloscope or low frequency spectrum analyzer. Output voltage: 1V rms \pm 5% open circuit for full scale meter indication, proportional to meter deflection. Output resistance: 1k Ω \pm 5%.

Auto set level: no set level adjustment required. Distortion measurements are made directly over 10 dB range selected by input range switch. Two LED annunciators provide a fast visual indication to change input range for valid distortion measurement. Correct range is indicated when both annunciators are extinguished.

Automatic fine tuning: using internal oscillator: No separate analyzer tuning necessary when using internal oscillator as signal source. Oscillator frequency controls simultaneously tune the analyzer. Using external frequency source: Two LED annunciators provide a quick visual indication for the operator to increase or decrease the frequency. When the analyzer is rough tuned to within one least significant digit of the fundamental frequency, the indicator lights are extinguished and the 339A auto-null circuitry takes over to provide a fast, accurate null without tedious operator tuning.

Input filters (usable on all functions): low pass: 30 kHz -3 dB point at 30 kHz, + 2.6 kHz, -3 kHz with 60 dB/decade rolloff. Provides band limiting required by FCC for proof-of-performance broadcast testing. 80 kHz -3 dB point at 80 kHz, + 7 kHz, -7.9 kHz with 60 dB/decade rolloff. Normally used with fundamental frequencies < 20 kHz to reduce the effect of higher frequency noise present in the measured signal. High Pass: 400 Hz - 3 dB point at 400 Hz, + 35 Hz, -40 Hz with 60 dB/decade rolloff. Normally used with fundamental frequencies > 1 kHz to reduce the effect of hum components in the input signal.

DC isolation: input low may be connected to chassis ground or floated to 30 V to reduce the effects of ground loops on the measurement.

Relative Input Level Mode

Provides a ratio measurement relative to an operator selected reference level with readout directly in dBV or dBm (600 Ω). Voltage range, frequency range, accuracy specifications, and monitor are the same as in Voltmeter mode. (Accuracy is relative to 0 dB set level input.)

Oscillator

Frequency range: 10 Hz to 100 kHz in 4 overlapping decade ranges with 2 digit resolution. Frequency vernier provides continuous frequency tuning between 2nd digit switch settings.

¹SINAD is a sensitivity measurement computed from the ratio of signal plus noise and distortion to noise and distortion.



SIGNAL ANALYZERS

Distortion Analyzers

Model 339A (cont.), 334A

Output level: variable from < 1 mV to > 3 V rms into $600\ \Omega$ with 10 dB/step Level control and > 10 dB Vernier adjustment. OSC Level position on function switch allows a quick check of oscillator level without disconnecting leads to device under test. Off position on Oscillator Level control provides fast signal-to-noise measurement capability. Oscillator output terminals remain terminated in $600\ \Omega$.

Frequency accuracy: $\pm 2\%$ of selected frequency (with Frequency Vernier in Cal position).

Level flatness: 20 Hz to 20 kHz: $\leq \pm 0.1$ dB
10 Hz to 110 kHz: $\leq \pm 0.2$ dB

Distortion ($\geq 600\ \Omega$ load, ≤ 3 V output)

10 Hz to 20 kHz: < -93 dB (0.0022%) THD
20 kHz to 30 kHz: < -85 dB (0.0056%) THD
30 kHz to 50 kHz: < -80 dB (0.01%) THD
50 kHz to 80 kHz: < -70 dB (0.032%) THD
80 kHz to 110 kHz: < -65 dB (0.056%) THD

Output resistance: $600\ \Omega \pm 5\%$

Voltmeter

Voltage range: 1 mV rms full scale to 300 V rms full scale (-60 dB to $+50$ dB full scale, meter calibrated in dBV and dBm into $600\ \Omega$).

Detection and meter indication: true rms detection for waveforms with crest factor ≤ 3 . Meter reads true rms volts, dBm into $600\ \Omega$, and dBV.

Accuracy (% of range setting)

20 Hz to 20 kHz: $\pm 2\%$

10 Hz to 110 kHz: $\pm 4\%$

Frequency range: 10 Hz to 110 kHz.

Input impedance: $100\ \text{k}\Omega \pm 1\%$ shunted by < 100 pF between input High to Low.

Monitor: provides scaled presentation of input signal for further analysis using oscilloscope or low frequency spectrum analyzer. Output voltage: 1 V rms $\pm 5\%$ open circuit for full scale meter indication, proportional to meter deflection. Output resistance: $1\ \text{k}\Omega \pm 5\%$.

Option 001

Voltage range: 0.1 mV rms full scale to 300 V rms full scale (-80 dBV to $+50$ dBV full scale); (.1 mV and .3 mV ranges—external source resistance must be $< 10\ \text{k}\Omega$.)

Accuracy: 1 mV to 300 V Ranges

20 Hz to 20 kHz $\pm 2\%$

10 Hz to 110 kHz

.1 mV and .3 mV Ranges

20 Hz to 20 kHz: $\pm 2\%$

10 Hz to 30 kHz: $\pm 4\%$

30 kHz to 80 kHz: $+10/-30\%$

Noise Floor (600 Ω source impedance)

30 kHz filter $< 6\ \mu\text{V}$

80 kHz filter $< 8\ \mu\text{V}$

AM Detector

Frequency range: carrier frequencies: 550 kHz to 1.6 MHz. Modulation frequencies: 20 Hz to 20 kHz.

Distortion introduced by AM detector (with 30 kHz filter switched IN): up to 85% Modulation: < -36 dB (1.6%) THD
85% to 95% Modulation: < -30 dB (3%) THD

Input level: maximum: 60V peak. Modulation signal level: 2V rms minimum; 10V rms maximum.

Monitor (with modulated RF carrier applied to AM detector input).

Distortion mode: provides scaled presentation of demodulated input signal after fundamental is removed.

Voltmeter and relative input mode: provides scaled presentation of demodulated input signal. Output voltage and output resistance are the same as in Distortion mode.

General

Power: 100/120/220/240 V $\pm 5\%$, -10% 48 Hz to 66 Hz line operation, 200 mA maximum.

Size: 146 mm H x 426 mm W x 375 mm D (5.75" x 16.75" x 14.75").

Weight: net 8.2 kg (18 lbs). Shipping 11.3 kg (25 lbs).

**339A Distortion Measurement Set
Option 001**

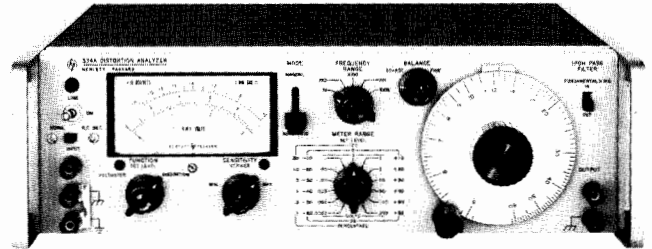

334A

Description

Hewlett-Packard's model 334A Distortion Analyzer measures total distortion down to 0.1% full scale at any frequency between 5 Hz and 600 kHz; harmonics are indicated up to 3 MHz. Noise levels as low as 25 microvolts can be measured. The HP 334A includes automatic fundamental nulling and amplitude modulation detector. A Meter with VU ballistic characteristics, and a 30 kHz low pass filter are optional.

334A Specifications

Input level for distortion measurements: 0.3 V rms for 100% set level or 0.245 V for 0 dB set level (up to 300 V may be attenuated to set level reference).

Harmonic Measurement Accuracy (full scale)

Fundamental Input Less Than 30 V

Range	$\pm 3\%$	$\pm 6\%$	$\pm 12\%$
100%–0.3%	10 Hz–1 MHz	10 Hz–3 MHz	
0.1%	30 Hz–300 kHz	20 Hz–500 kHz	10 Hz–1.2 MHz

Fundamental rejection: > 80 dB

Residual distortion: > -70 dB (0.03%) from 5 Hz to 200 kHz. > -64 dB (0.06%) from 200 kHz to 600 kHz. Meter indication is proportional to average value of a sine wave.

Frequency calibration accuracy: better than $\pm 5\%$ from 5 Hz to 300 kHz. Better than $\pm 10\%$ from 300 to 600 kHz.

Input impedance: distortion mode: $1\ \text{M}\Omega \pm 5\%$ shunted by < 70 pF.

DC isolation: signal ground may be ± 400 V dc from external chassis

Voltmeter range: 300 μV to 300 V rms full scale (13 ranges) 10 dB per range. Average responding calibrated in rms.

Noise measurements: voltmeter residual noise on the 300 μV range: $< 25\ \mu\text{V}$ rms, when terminated in 600 (shielded) ohms.

Output: 0.1 ± 0.01 V rms open circuit.

Output impedance: 2 k Ω

Automatic nulling mode: set level: at least 0.2 V rms

Frequency ranges: X1, manual null tuned to less than 3% set level: total frequency hold-in $\pm 0.5\%$ about true manual null. X10 through X10k, manual null tuned to less than 10% of set level; total frequency hold-in $\pm 1\%$ about true manual null.

Automatic null accuracy: 5 Hz to 100 Hz: meter reading within 0 to $+3$ dB of manual null. 100 Hz to 600 kHz: meter reading within 0 to $+1.5$ dB of manual null.

High pass filter: 3 dB point at 400 Hz with 18 dB per octave roll off.

AM detector: 550 kHz to 65 MHz; 40 Vp-p max input.

Distortion introduced by detector: carrier frequency: 550 kHz–1.6 MHz: < 50 dB (0.3%) for 3–8 V rms carriers modulated 30%. 1.6 MHz–65 MHz: < 40 dB (1%) for 3–8 V rms carriers modulated 30%.

General

Power: 115 or 230 V $\pm 10\%$. 48 to 66 Hz.

Size: 426 mm W x 126 mm H x 337 mm D (16.75" x 5" x 13.25").

Weight: net 7.89 kg (17.75 lb). Shipping 10.35 kg (23 lb).

334A Distortion Analyzer

Opt 001 VU Characteristics

Opt 002 30 kHz low pass filter

Opt 003 (combined 001 and 002)

SIGNAL ANALYZERS

15 Hz to 50 kHz Wave Analyzer

Model 3581A

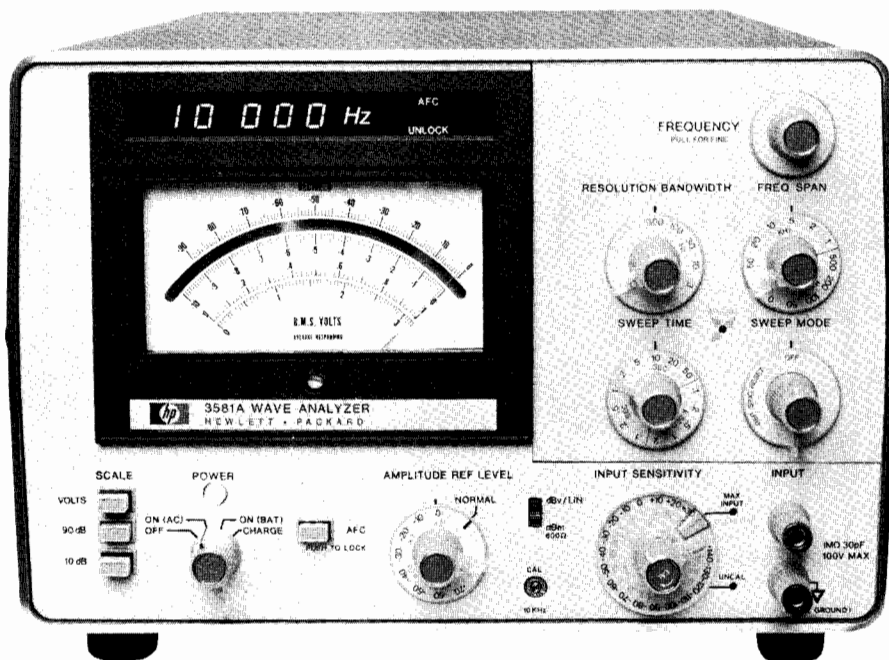
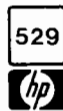

Description

Hewlett-Packard's 3581A Wave Analyzer resolves and measures the amplitude and frequency of spectral components. This instrument offers accurate amplitude and good frequency resolution in the form of a portable, easy to use measuring tool. Since not all signals originate from a stable frequency source, the 3581A incorporates an AFC circuit which locks to a drifting signal for stable, accurate measurements.

HP's 3581A has other important features that are necessary when making measurements of small voltages from transducers and harmonic signals. Its 30 nV sensitivity becomes important for these measurements. Battery operation can be used to reduce the line related interference common in low level measurements so only the real spectrum is measured.

Digital readout of tuned frequency is located above the analog meter. It has been grouped with the meter for ease of reading. Resolution of the digital readout is 1 Hz for any frequency between 15 Hz and 50 kHz. Readout is updated five times per second so delay between tuning and reading is minimized.

Four meter scales are used to provide a wide range of displays. Two scales are used for linear voltage readings. Two log scales provide either a 90 dB or 10 dB display. In any case, the large meter with its mirror backing can present readings in dBV, dBm or volts. A meter was specifically chosen for amplitude display rather than digital readout because it is easier to peak a meter reading and because it's much easier to get a feel for noise or other amplitude variations by watching the meter. The same voltage used to drive the meter is also available on the rear panel for driving X-Y recorders.

Specifications

Frequency Characteristics

Range: 15 Hz to 50 kHz.

Display: 5 digit LED readout.

Resolution: 1 Hz.

Accuracy: ± 3.5 Hz., 0 to 55°C.

Typical stability: ± 10 Hz/hr after 1 hour and ± 5 Hz/°C.

Automatic frequency control (AFC) hold-in range: ± 800 Hz.

Amplitude Characteristics

Instrument Range

Linear: 30 V to 100 nV full scale.

Log: +30 dBm or dBV to -150 dBm or dBV.

Amplitude Accuracy	Log	Linear
Frequency response, 15 Hz-50 kHz	± 0.4 dB	$\pm 4\%$

Dynamic range: > 80 dB.

Noise sidebands: greater than 70 dB below CW signal. 10 bandwidths away from signal.

Spurious responses: > 80 dB below input reference level.

Sweep Characteristics

Scan width: 50 Hz to 50 kHz, adjustable in a 1-2-5 sequence from 50 Hz to the full frequency range.

Sweep error light: this LED indicates a sweep that is too fast to capture full response. When the light is on, response will be lower than it should be.

External trigger: a short to ground stops the normal sweep. Opening the short then enables a sweep.

Input Characteristics

Impedance: 1 M Ω , 30 pF.

Maximum input level: 100 V rms, ± 100 V dc.

Output Characteristics

Tracking generator output: (also known as BFO or tracking oscillator output).

Range: 0 to > 1 V rms into 600 Ω .

Frequency response: $\pm 3\%$ 15 Hz to 50 kHz.

X-Y Recorder Analog Outputs

Vertical: 0 to +5 V $\pm 2.5\%$.

Horizontal: 0 to +5 V $\pm 2.5\%$.

Impedance: 1 k Ω .

Pen lift: contact closure to ground during sweep.

Restored output: acts as a narrow band amplifier.

General

Power requirements: 100 V, 120 V, 220 V, or 240 V $+5\%$ -10%, 48 Hz to 440 Hz, 10 VA typical.

Size: 412.8 mm H x 203.2 mm W x 285.8 mm D (16 $\frac{1}{4}$ " x 8" x 11 $\frac{1}{4}$ ").

Weight: 11.5 kg (23 lb). Opt 001: 13.5 kg (30 lb).

Options

3581A Wave Analyzer

001: Internal battery 12 hours from full charge. Internal battery is protected from deep discharge by an automatic turnoff. Useful battery life is over 100 cycles.

003: Rack Mount

910: Extra set manuals

SIGNAL ANALYZERS

Modulation Analyzer, 150 kHz to 1300 MHz
Models 8901A, 8901B

- Measures AM and FM to 1% accuracy
- Measures RF frequency
- Measures RF Power

- Low internal noise
- Completely automatic

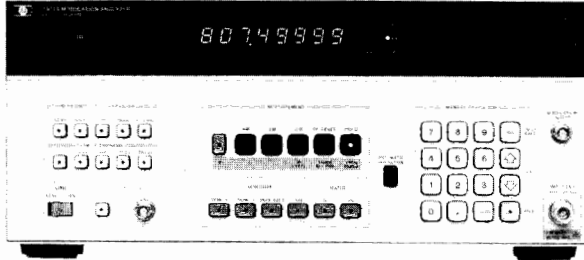

8901A

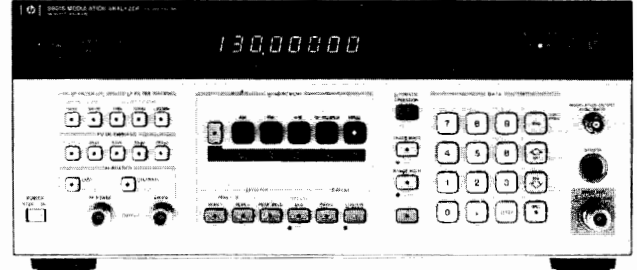

8901B

8901A and 8901B Modulation Analyzers

The 8901A and 8901B Modulation Analyzers combine the capabilities of several RF instruments to give complete, accurate characterization of modulated signals in the 150 kHz to 1300 MHz frequency range. Both instruments very accurately measure modulation and recover the modulation signal. They determine RF frequency and measure RF power. The major additional capabilities of the 8901B are its improved power meter accuracy, its ability to use external power sensors and its ability to count audio frequencies and measure distortion on 400 Hz and 1 kHz signals. Both instruments are fully automatic and make all major measurements with the push of a key or under HP-IB control.

Modulation Measurement Accuracy

Very accurate modulation measurements along with very low internal noise enable the 8901A/B to characterize even high performance signal sources. Their detection systems are configured for wideband recovery of the entire modulation spectrum so that highly precise measurements such as signal-to-noise or distortion can be made on the modulation signal. Modulation depth and deviation accuracy is generally $\pm 1\%$ of reading. Residual AM noise in a 50 Hz to 3 kHz bandwidth is $<0.01\%$ while FM noise is <8 Hz for 1300 MHz carrier frequencies, decreasing linearly to <1 Hz below 100 MHz. Because the AM and FM demodulators are independent and highly insensitive to each other and because the analyzer has very low residual AM and FM, accurate incidental AM and FM measurements can be made.

Three detectors are available for depth and deviation measurements: positive peak, negative peak, and an average-responding detector with rms (sinewave) calibration. The 8901B also has a true rms detector and the ability to measure peak to peak divided by two. A PEAK HOLD function captures and displays the maximum peak modulation of a signal and is ideal for making transient measurements such as modulation limiting on mobile radios.

For measuring convenience, two high-pass (50 Hz and 300 Hz) and three low-pass (3 kHz, 5 kHz and >20 kHz) post-detection filters for filtering the recovered modulation are included. The >20 kHz Bessel filter minimizes overshoot on square wave modulation. This allows accurate measurement of signals which are digitally modulated, such as FSK. Four de-emphasis networks commonly used in FM systems (25, 50, 75, and 750 μ s) are also provided.

A modulation output provides calibrated signal levels relative to the displayed modulation reading. The 8901B can make measurements on this demodulated signal such as frequency and distortion level.

Modulation calibrators (standard on the 8901B, Option 010 on the 8901A) provide two precision modulation standards. One is an amplitude modulated signal whose depth is calibrated to better than 0.1% accuracy. The second standard is a frequency modulated signal with peak deviation calibrated to 0.1% accuracy. The 11715A AM/FM Test Source is necessary to fully test and calibrate other modulation parameters.

Complete Signal Characterization

The 8901A/B Modulation Analyzers are more than just high quality modulation meters. They also perform as frequency counters and power meters. Resolution for the 8901A's 150 kHz to 1300 MHz frequency counter is 10 Hz below 1000 MHz and 100 Hz above 1000 MHz. Resolution is 10 Hz for the 8901B. Sensitivity is -25 dBm (12 mV rms) below 650 MHz and -20 dBm (22 mV rms) above 650 MHz. The standard instrument's time base stability is 1×10^{-6} /month, or an optional time base is available with 1×10^{-9} /day stability.

The 8901A uses a diode detection circuit to measure RF input power. This technique measures peak voltage and is calibrated from 1 mW to 1 W for sine wave inputs. The RF level measurement accuracy is ± 1.5 dB from 150 MHz to 1300 MHz.

The 8901B delivers the accuracy and resolution of a high performance power meter. The 8901B, with the 11722A Sensor Module, measures power from $+30$ dBm to -20 dBm at frequencies from 100 kHz to 2.6 GHz. The 8901B also accepts all HP 8480 series power sensors for extended measurement capability.

8901A/8901B Specifications

RF Input

Frequency range: 150 kHz to 1300 MHz

Operating Level

150 kHz–650 MHz: 12 mVrms to 7 Vrms

650 MHz–1300 MHz: 22 mVrms to 7 Vrms

Input impedance: 50 Ω nominal

Tuning: manual frequency entry, automatic, or track (frequencies >10 MHz only).

Acquisition time (automatic operation): ~ 1.5 seconds.

Maximum safe input level (typical): ac: 35 Vrms (25 W for source SWR <4); dc: 40 V.

Frequency Modulation

Rates

150 MHz–10 MHz: 20 Hz to 10 kHz

10 MHz–1300 MHz: 20 Hz to 200 kHz

10 MHz–1300 MHz: 20 Hz to 20 kHz with 750 μ s filter.

Deviations

150 kHz–10 MHz: 40 kHz peak maximum

10 MHz–1300 MHz: 400 kHz peak maximum

10 MHz–1300 MHz: 40 kHz peak maximum with 750 μ s filter.

Accuracy¹

250 kHz–10 MHz: $\pm 2\%$ of reading ± 1 digit, 20 Hz to 10 kHz rates.

10 MHz–1300 MHz: $\pm 1\%$ of reading ± 1 digit, 50 Hz to 100 kHz rates, $\pm 5\%$ of reading ± 1 digit, 20 Hz to 200 kHz rates.

Demodulated Output Distortion²

400 kHz–10 MHz: $<0.1\%$ THD, deviations <10 kHz.

10 MHz–1300 MHz: $<0.1\%$ THD, rates and deviations <100 kHz.

AM rejection (for 50% AM at 400 Hz and 1 kHz rates): <20 Hz peak deviation measured in a 50 Hz to 3 kHz BW.

¹ Peak residuals must be accounted for in peak readings.

² With 750 μ s de-emphasis and pre-display "off", distortion is not specified for modulation outputs >4 V peak. This can occur near maximum deviation for a measurement range at rates <2 kHz.

Residual FM (50 Hz to 3 kHz BW): <8 Hz rms @ 1300 MHz, decreasing linearly with frequency to <1 Hz rms for 100 MHz and below.

Maximum Deviation Resolution

1 Hz, <4 kHz deviation
10 Hz, 4 kHz to 40 kHz deviation
100 Hz, 40 kHz to 400 kHz deviation
Resolution is increased one digit with 750 μs de-emphasis and predisplay "on" and with rms detector.

Stereo separation (50 Hz to 15 kHz): >47 dB typical.

Phase Modulation

Carrier frequency: 10 MHz to 1300 MHz.
Rates: 200 Hz to 20 kHz; typically useable from 20 Hz to 100 kHz with degraded performance.

Deviation and Maximum Resolution

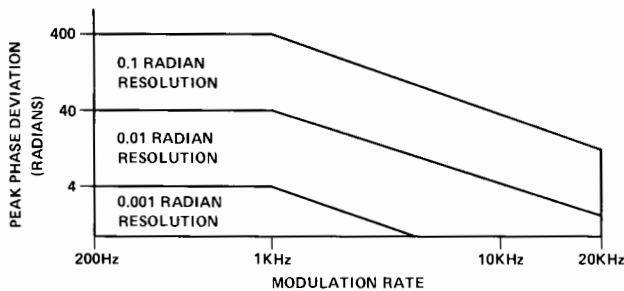

Accuracy¹: ±3% of reading ±1 digit
Demodulated output distortion: <0.1% THD
AM rejection (for 50% AM at 1 kHz rate)¹: <0.03 radian peak deviation (50 Hz to 3 kHz BW)

Amplitude Modulation

Rates
150 kHz–10 MHz: 20 Hz to 10 kHz
10 MHz–1300 MHz: 20 Hz to 100 kHz.
Depth: to 99%

Accuracy^{1,2}
150 kHz–10 MHz: ±2% of reading ±1 digit, 50 Hz to 10 kHz rates, >5% depth; ±3% of reading ±1 digit, 20 Hz to 10 kHz rates.
10 MHz–1300 MHz: ±1% of reading ±1 digit, 50 Hz to 50 kHz rates, >5% depth; ±3% of reading ±1 digit, 20 Hz to 100 kHz rates.

Flatness (variation in indicated AM depth for constant depth on input signal): 10 MHz to 1300 MHz: ±0.3% of reading ±1 digit, 90 Hz to 10 kHz rates, 20 to 80% depth.

Demodulated output distortion: <0.3% THD for ≤50% depth; <0.6% THD for ≤95% depth.

FM Rejection (at 400 Hz and 1 kHz rates, 50 Hz to 3 kHz BW)¹
250 kHz to 10 MHz: <0.2% AM for <5 kHz peak deviation.

10 MHz to 1300 MHz: <0.2% AM for <50 kHz peak deviation.
Residual AM (50 Hz to 3 kHz BW): <0.01% rms.

Maximum Depth Resolution
0.01% for depths ≤39.99%; 0.1% for depths ≥40%. Resolution increases 1 digit with rms detector.

Frequency Counter

Range: 150 kHz-1300 MHz.
Accuracy: reference accuracy ±3 counts of least significant digit.

Internal Reference

Frequency: 10 MHz.
Aging rate: <1x10⁻⁶/month (optional³: 1x10⁻⁹/day).

Maximum Resolution

8901A: 10 Hz for frequencies <1 GHz; 100 Hz for frequencies ≥1 GHz.

8901B: 10 Hz.

¹Peak residuals must be accounted for in peak readings.
²For peak measurements only, AM accuracy may be affected by distortion generated by the Modulation Analyzer. In the worst case, this can decrease accuracy by 0.1% of reading for each 0.1% of distortion.
³After 30 day warm-up.

8901A RF Level (peak voltage responding, rms sine wave power calibrated)

Range: 1 mW to 1 W
Instrumentation accuracy: ±1.5 dB (150 KHz to 1300 MHz); 0.7 dB typical.
SWR: ≤650 MHz: ≤1.3; 1300 MHz: ≤1.5.
Resolution: 0.1 mW for level 0.1 to 1 W.
0.01 mW for levels 0.01 to 0.1W.
0.001 mW for levels <0.01W.

8901B RF Level (true RMS)

Frequency range with 11722A: 100 kHz to 2.6 GHz.
Power range: -20 dBm to +30 dBm.
RF Range Linearity (using recorder output)
±0.02 dB, RF ranges 2 – 5
±0.03 dB, RF range 1
Using front-panel display, add ±1 count of least-significant digit.
RF Range-to-Range Change Error
±0.02 dB/RF range change from reference range
Input SWR: <1.15, using 11722A Sensor Module
Zero Set (digital settability of zero)
±0.07% of full scale on lowest range.
Decrease by a factor of 10 for each high range.
RF Power Resolution
0.1% of full scale in watts or volts mode,
0.01 in dBm or dB relative mode.

Power Reference

Power output: 1.00 mW. Factory set to ±0.7%, traceable to the U.S. National Bureau of Standards.
Accuracy: ±1.2% worst case (±0.9% rss) for one year (0°C to 55°C).

Audio Filters

High pass (3 dB cutoff frequency): 50 Hz and 300 Hz
Low pass (3 dB cutoff frequency except >20 kHz filter): 3 kHz, 15 kHz, >20 kHz.
De-emphasis filters: 25 μs, 50 μs, 75 μs, and 750 μs.

Calibrators (standard 8901B, option 010 8901A)

AM calibrator depth and accuracy: 33.33% depth, nominal; internally calibrated to an accuracy of ±0.1%.
FM calibrator deviation and accuracy: 34 kHz peak deviation, nominal; internally calibrated to an accuracy of ±0.1%.

General Characteristics

Operating temperature range: 0° to 55°C.
Power requirements: 100, 120, 220, or 240 V ac (+5, -10%); 48-66 Hz; 200 VA max.
Weight: 8901A net, 20 kg (44 lb). Shipping, 25 kg (55 lb); 8901B net, 23 kg (52 lb). Shipping 31 kg (69 lb)
Size: 8901A, 190 mm H x 425 mm W x 468 mm D (7.5 in. x 16.8 in. x 18.4 in.); 8901B, 190 mm H x 425 mm W x 551 mm D (7.5 in. x 16.8 in. x 21.7 in.)

Ordering Information

8901A Modulation Analyzer
Option 001: Rear panel connectors
Option 002: 1x10⁻⁹/day internal reference
Option 003: Connections for external local oscillator
Option 004: Operation from 48 to 440 Hz power (Temp. <40°C)
Option 010: AM and FM calibrators
8901B Modulation Analyzer
Option 001: Rear panel connectors
Option 002: 1x10⁻⁹/day internal reference
Option 003: Connections for external local oscillator
Option 004: Operation from 48 to 440 Hz power (Temp. <40°C)

SIGNAL ANALYZERS

150 kHz to 1300 MHz

Model 8902A

- RF power: digital power meter accuracy
- Tuned RF level: 0 dBm to -127 dBm dynamic range
- AM and FM: 1% accuracy ϕ M: 3% accuracy
- RF frequency: 10 Hz resolution
- Audio: frequency, level and distortion

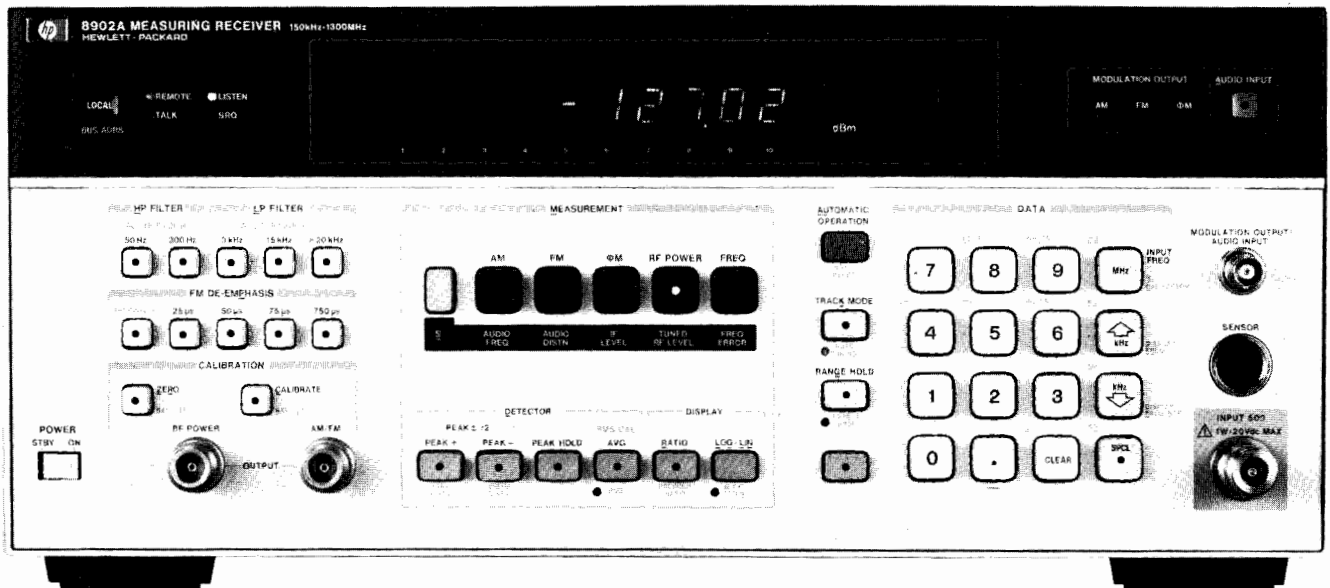

8902 Measuring Receiver

The 8902A Measuring Receiver combines five precise measurement functions into one fully automatic, HP-IB programmable instrument. It accurately measures RF power, tuned RF level, modulation and RF frequency, and characterizes audio signals. For precise signal analysis, the 8902A Measuring Receiver provides the performance you need.

RF Power delivers the accuracy and resolution of a high performance power meter. The 8902A with the 11722A Sensor Module measures power from +30 dBm to -20 dBm at frequencies from 100 kHz to 2.6 GHz. The 8902A also accepts all HP 8480 series power sensors for extended measurement capability.

Tuned RF Level's minimum sensitivity of -127 dBm with exceptional accuracy is a major contribution of the 8902A. You can make relative level measurements with accuracy you would only expect from a transfer standard: 0.01 dB \pm 1 digit (worst case) for up to 10 dB step, increasing to \pm 0.29 dB \pm 1 digit at 110 dB step.

AM and FM measurements offer 1% accuracy (3% accuracy for ϕ M) and fast one-key operation. The 8902A has extremely low internal noise, and very low AM/ ϕ M and ϕ M/AM conversion, for accurately measuring residual and incidental AM, FM and ϕ M on a wide range of simple and complex modulated signals.

RF frequency of complex modulated signals can be difficult to measure, but not with the 8902A. It tunes to the largest input signal or to any user specified frequency. The 8902A counts signals with 10 Hz resolution.

Audio distortion, frequency and level measurements provide comprehensive characterization of the modulation signal.

Metrology and Calibration

The 8902A Measuring Receiver makes signal generator and attenuator calibration easier than ever before.

The 8902A quickly and accurately measures your signal generator's RF frequency, RF level flatness, output level accuracy to -127

dBm, incidental and residual AM, FM and phase modulation and characterizes the demodulated audio signals.

For attenuator calibration and other relative measurements, the 8902A gives you the accuracy and dynamic range you need. Tuned RF Level makes relative measurements with 127 dB dynamic range and 0.01 dB resolution. The combined dynamic range of Tuned RF and RF Power is 157 dB.

RF Signal Characterization

The 8902A Measuring Receiver is an excellent lab and production tool for accurately characterizing RF signals from 150 kHz to 1300 MHz.

Level measurements down to -127 dBm with superb accuracy make the 8902A ideal for testing devices such as antennas, multiplexers, Log/Linear amplifiers, filters and mixers. Unlike diode detectors, the 8902A's power meter accurately measures signals with harmonics and spurious.

The 8902A makes accurate AM to ϕ M and AM to AM conversion measurements of phase and amplitude sensitive devices such as band-pass filters and multiple channel receivers. Excellent isolation between AM and FM makes it simple to separate the AM and ϕ M of AM stereo, incidental AM of FM transmitters and the AM, FM and ϕ M components of complex signals.

Automatic Test Systems

The 8902A is an important component of automatic RF test systems. All functions — power, level, frequency count, modulation, audio analysis — are fully automatic and easily programmed. With these measurements combined into one instrument, interfacing requirements, hardware costs, and software development time are reduced.

The 8902A's excellent measurement accuracy and dynamic range also make it a valuable tool for calibrating automatic test systems.

SIGNAL ANALYZERS

Measuring Receiver, Signal Generator Test Set

Models 8902A, 8952A, 11795A



8902A Specifications

RF Power (with 11722A Sensor Module)

Range: +30 dBm (1W) to -20 dBm (10 μ W)
Frequency range: 0.1 MHz to 2.6 GHz.
Linearity: ± 0.02 dB (within range) ± 0.02 dB per range change from reference range ± 0.5 digit.
Input SWR: <1.15

Tuned RF Level

Range: 0 dBm to -127 dBm.
Frequency range: 2.5 MHz to 1300 MHz.
Relative accuracy: 0.01 dB ± 0.02 dB per IF range change ± 0.04 dB per RF range change.

RF Frequency

Range: 150 kHz to 1300 MHz.
Maximum resolution: 10 Hz.

Amplitude Modulation

Rates: 20 Hz to 100 kHz.
Depths: to 99%
Accuracy: $\pm 1\%$ of reading 1 digit, for rates 50 Hz to 50 kHz and depths $\geq 5\%$.

Frequency Modulation

Rates: 20 Hz to 200 kHz.
Deviations: to 400 kHz.
Accuracy: $\pm 1\%$ of reading ± 1 digit, for rates 50 Hz to 100 kHz.

Phase Modulation

Rates: 200 Hz to 20 kHz.
Deviations: to 400 radians.
Accuracy: $\pm 3\%$ of reading ± 1 digit.

Audio Level, Frequency and Distortion Capability

Audio Level

Accuracy: $\pm 4\%$ of reading, 100 mV to 3 V.

Audio Frequency

Display resolution: 6 digits, to 250 kHz.

Audio Distortion

Accuracy: ± 1 dB, 400 Hz and 1 kHz.

Ordering Information

8902A Measuring Receiver

- Option 001:** rear panel instead of front panel connections for input, modulation output, and calibrators
- Option 002:** 1×10^{-9} /day internal reference oscillator
- Option 003:** Rear panel connections which allow use with an external local oscillator
- Option 004:** Operation from 48 Hz to 400 Hz power line (Temp. $< 40^\circ\text{C}$)
- Option 021:** Add 11722A Sensor Module
- Option 907:** Front panel handle kit
- Option 908:** Rack mounting flange kit
- Option 909:** Front panel handle plus rack mounting flange kit
- Option 910:** Extra manuals

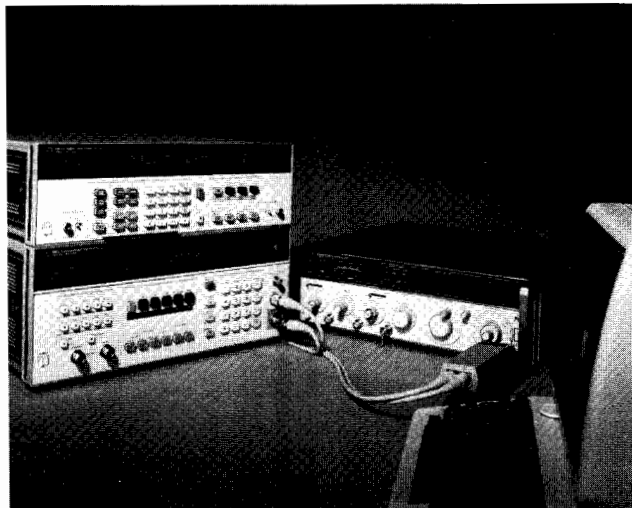

8952A

8952A Signal Generator Test Set

The 8952A Signal Generator Test Set eases your signal calibration workload, performing automatic performance verification for incoming inspection, maintenance, and calibration. The 8952A includes the 8902A Measuring Receiver and the HP 8903A Audio Analyzer. It can be ordered with the HP 82905B Impact Printer and your choice of three HP Series 200 controllers: Model 16, 26, and 36.

The 8952A Test Set makes fast, accurate and repeatable measurements and provides you with a hardcopy output of the results. The system is easy to use and is easily expanded to include additional instruments.

To test your HP signal generators, select from the HP 11795A Software Pac series. Each Software Pac follows the verification procedures called out by the appropriate signal generator service manual.

These software pacs include instrument drivers for adding an HP 8568A or HP 8566A Spectrum Analyzer, HP 1980B Oscilloscope Measurement System, or HP 8116A Pulse/Function Generator to your system.

Ordering Information

8952A Signal Generator Test Set

11795A Software Pac

Option 101, User Interface and Instrument Drivers (Required to run 200 series software options)

Software Options (select one or more)

204, 8640B Performance Verification software

208, 8656A Performance Verification software

214, 8662A Performance Verification software

Disc Medium Options (select only one)

630, 3.5 inch disc medium for 9121S/D or 9133A

650, 5.25 inch disc medium for 82901M or 9135A

655, 5.25 inch disc medium for 9826S/9836S

SIGNAL ANALYZERS

Sensor; AM/FM Test Source

Models 11722A, 11715A

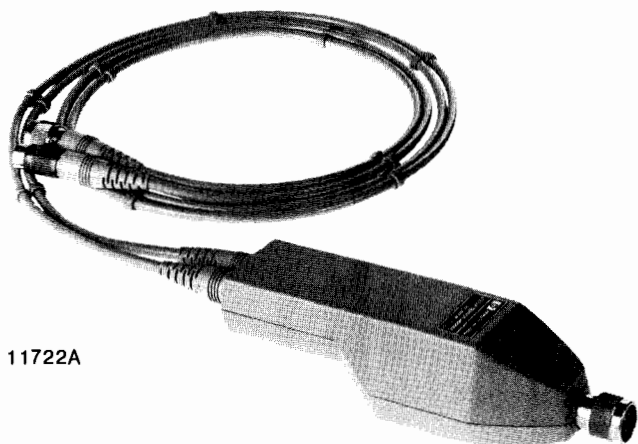

11722A

11722A Sensor Module

The 11722A Sensor Module was designed for use with the 8901B Modulation Analyzer and 8902A Measuring Receiver. The 11722A contains a silicon monolithic thermocouple as a power sensing element.

With the 11722A Sensor Module, you get all the performance of the 8901B or 8902A, plus superb power measurement accuracy, at a single connector. You can characterize a signal without switching back and forth between the power sensor and the analyzer's RF input.

Each 11722A Sensor Module is individually calibrated, traceable to the U.S. National Bureau of Standards. The calibration factors are printed on the sensor module for easy reference. Enter these factors into the 8901B's or 8902A's non-volatile memory and the instrument automatically compensates for the power sensor's efficiency and mismatch loss at each frequency.

11722A Specifications

Frequency range: 100 kHz to 2.6 GHz.

Power range: +30 dBm (1 watt) to -20 dBm (10 μ W).

Input SWR (Connected to an 8901B or 8902A): <1.15, for RF Power Measurements.

Power sensor linearity: +2%, -4%; +30 dBm to +20 dBm. Negligible deviation, levels <+20 dBm.

Calibration factors: each 11722A Sensor Module is individually calibrated. The calibration factors are printed on the 11722A Sensor Module for easy reference.

Cal Factor Uncertainty

Frequency	RSS Uncertainty	Worst Case Uncertainty
0.1 MHz	0.7%	1.6%
0.3 MHz	0.7%	1.6%
1.0 MHz	0.8%	1.7%
3.0 MHz	0.8%	1.7%
10.0 MHz	0.9%	2.0%
30.0 MHz	0.9%	2.0%
50.0 MHz	0.0% (ref.)	0.0% (ref.)
100.0 MHz	1.1%	2.2%
300.0 MHz	1.1%	2.2%
1000.0 MHz	1.1%	2.2%
2600.0 MHz	1.2%	2.3%

Ordering Information

11722A Sensor Module

Option 910: Extra manual

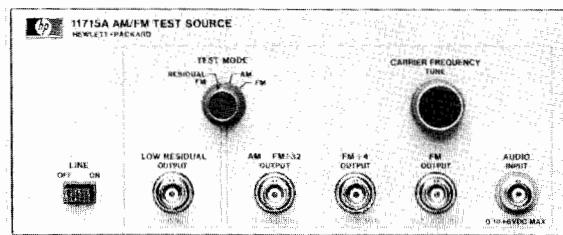

11715A

11715A AM/FM Test Source

The 11715A AM/FM Test Source provides very flat, wide-bandwidth, and low distortion amplitude or frequency modulated RF signals. Designed primarily for performance tests and adjustments of the 8901A/8901B Modulation Analyzer and 8902A Measuring Receiver, it will also serve as a high quality modulated test oscillator where its frequency ranges apply.

The major components of the 11715A are a low-noise voltage controlled oscillator (VCO), two digital dividers, and a double balanced mixer. The VCO is the primary signal source, with a typical frequency range of 330 to 470 MHz at the FM OUTPUT. FM is produced by directly coupling the external modulation source to the VCO's tune input, providing very wide bandwidth modulation with low phase shift. This design also ensures very little incidental AM.

The 11715A can also be used in conjunction with an 8901A/8901B/8902A as a calibrated signal source for special applications. In particular, the U.S. commercial FM broadcast band of 88 to 108 MHz is covered by the FM \div 4 OUTPUT of the 11715A.

11715A Specifications

FM Outputs

Frequency Range

AM FM \div 32 output: 11 to 13.5 MHz

FM \div 4 output: 88 to 108 MHz

FM output: 352 to 432 MHz

Peak Deviation

11 to 13.15 MHz carrier: >12.5 kHz

88 to 108 MHz carrier: >100 kHz

352 to 432 MHz carrier: >400 kHz

Distortion

<0.025% THD (<-72 dB) for

Carrier frequency	Peak deviation	Modulation rate
12.5 MHz	12.5 kHz	<10 kHz
100 MHz	100 kHz	<100 kHz
400 MHz	400 kHz	<100 kHz

Flatness

dc to 100 kHz rates: \pm 0.1%

dc to 200 kHz rates: \pm 0.25%

Stereo separation (88 to 108 MHz carrier, 75 kHz peak deviation, 1 kHz rate): >60 dB typical

AM Output

Frequency range (AM FM \div 32 output): 11 to 13.5 MHz

Depth: to 99%

Distortion

50% AM, 20 Hz to 100 kHz rates: <0.05% THD (<-66 dB)

95% AM, 20 Hz to 100 kHz rates: <0.1% THD (<-60 dB)

Flatness: 50 Hz to 50 kHz rates, \pm 0.1%;

20 Hz to 100 kHz rates, \pm 0.25%

Linearity: <95% AM, \pm 0.1%; <99% AM, \pm 0.2%

Ordering Information

11715A AM/FM Test Source



SIGNAL ANALYZERS

Audio Analyzer 20 Hz to 100 kHz

Model 8903A (cont.)

8903A Specifications

Source

Frequency range: 20 Hz to 100 kHz.

Frequency resolution: 0.3%

Frequency accuracy: 0.3% of setting.

Output level range: 0.6 mV to 6V open circuit.

Output level resolution: 0.3% or better.

Output level accuracy (open circuit): 2% of setting, 60 mV to 6V, 20 Hz to 50 kHz; 3% of setting, 6 mV to 6V, 20 Hz to 100 kHz; 5% of setting, 0.6 mV to 6 mV, 20 Hz to 100 kHz.

Flatness (1 kHz reference): $\pm 0.7\%$, 20 Hz to 20 kHz; $\pm 2.5\%$, 20 Hz to 100 kHz.

Distortion & noise: the higher of: -80 dB or $30 \mu\text{V}$, 20 Hz to 20 kHz, 80 kHz BW; -70 dB or $95 \mu\text{V}$, 20 kHz to 50 kHz, 500 kHz BW; -65 dB or $169 \mu\text{V}$, 50 kHz to 100 kHz, 500 kHz BW.

Impedance: $600\Omega \pm 1\%$.

Sweep mode: logarithmic sweep with up to 500 points/decade or 255 points between entered start and stop frequencies, whichever is smaller.

AC Level

Full range display: 300.0V, 30.00V, 3.000V, 0.3000V, 30.00mV, 3.000 mV, 0.3000mV.

Overrange: 33% except on 300V range.

Accuracy: $\pm 2\%$ of reading, 30V to 300V, 20 Hz to 1 kHz; $\pm 2\%$ of reading, 50 mV to 30V, 20 Hz to 20 kHz; $\pm 4\%$ of reading, 0.3 mV to 30V, 20 Hz to 100 kHz.

AC Converter: true-rms responding for signals with crest factor ≤ 3 and harmonics up to 80 kHz typical. 3 dB measurement BW: > 500 kHz typical. Average detection selectable by internal jumpers.

DC Level

Full range display: 300.0V, 48.00 V, 16.00V, 4.00V.

Overrange: 33% except on 300V range.

Accuracy: $\pm 0.75\%$ of reading, 400 mV to 300V; ± 3 mV, < 400 mV.

Distortion

Fundamental frequency range: 20 Hz to 100 kHz.

Display range: 0.001% to 100%, -99.99 dB to 0 dB.

Accuracy: ± 1 dB, 20 Hz to 20 kHz; ± 2 dB, 20 kHz to 100 kHz.

Input voltage range: 50 mV to 300V.

Residual noise and distortion: the higher of: 0.01%, -80 dB, or $30 \mu\text{V}$, 20 Hz to 20 kHz, 80 kHz BW; 0.032%, -70 dB, or $95 \mu\text{V}$, 20 kHz to 50 kHz, 500 kHz BW; 0.056%, -65 dB, or $169 \mu\text{V}$, 50 kHz to 100 kHz, 500 kHz BW.

Displayed resolution: 0.0001%, $< 0.1\%$ distortion; 0.001%, 0.1% to 3% distortion; .01%, 3% to 30% distortion; 0.1%, $> 30\%$ distortion.

Detection: true rms (average detection selectable by internal jumpers).

SINAD^{1,2}

Fundamental frequency range: 20 Hz to 100 kHz.

Display range: 0 dB to 99.99 dB.

Accuracy: ± 1 dB, 20 Hz to 20 kHz; ± 2 dB, 20 kHz to 100 kHz.

Input voltage range: 50 mV to 300V.

Detection: true rms (average detection selectable by internal jumpers).

Resolution: 0.01 dB for SINAD ratios > 25 . For ratios < 25 the display is rounded to the nearest half dB to reduce digit flickering of noise signals. (Full resolution is available by defeating this feature using special function 16.1.)

Analog meter: active in SINAD only and for SINAD ratios < 18 dB (or 24 dB using special function 7.1.)

Tuning: notch filter is tuned to analyzer source frequency.

Signal to Noise

Frequency range: 20 Hz to 100 kHz.

Display range: 0 dB to 99.99 dB.

Accuracy: ± 1 dB.

¹SINAD is a sensitivity measurement computed from the ratio of signal plus noise and distortion to noise and distortion.

²Residual noise and distortion same as for distortion mode.

Input voltage range: 50 mV to 300V.

Residual noise: the higher of -80 dB or $30 \mu\text{V}$, 80 kHz BW; -70 dB or $95 \mu\text{V}$, 500 kHz BW.

Resolution: same as SINAD.

Operation: the analyzer displays the ratio of the input voltages as the internal source is automatically switched on and off.

Frequency Counter

Range: 20 Hz to 150 kHz³.

Resolution: 5 digits⁴.

Accuracy: $0.004\% \pm 1$ digit.

Input sensitivity: 50 mV in distortion and SINAD modes, 5.0 mV in ac level and sig/noise modes.

Counting technique: reciprocal with 2 MHz timebase.

Audio Filters

400 Hz high pass filter: 3 dB cutoff frequency, 400 Hz ± 40 Hz; 140 dB/decade rolloff.

Psophometric filter (CCITT recommendation P53): deviation from ideal response: ± 0.2 dB at 800 Hz; ± 1 dB, 300 Hz to 3 kHz; ± 2 dB, 50 Hz to 3.5 kHz; ± 3 dB, 3.5 kHz to 5 kHz.

30 kHz low pass filter: 3 dB cutoff frequency, 30 kHz ± 2 kHz; 60 dB/decade rolloff.

80 kHz low pass filter: 3 dB cutoff frequency, 80 kHz ± 4 kHz; 60 dB/decade rolloff.

Rear Panel Inputs/Outputs

Recorder output: X: 0-10 Vdc (typical) corresponding to log of oscillator frequency.

Y: 0-10 Vdc (typical) corresponding to displayed value and entered plot limits.

Recorder output resistance: 1 k Ω nominal.

Monitor output: in ac level mode provides scaled output of measured input signal. In SINAD, distortion, and distortion level modes provides scaled output of input signal with the fundamental removed.

General

Input impedance: 100k $\Omega \pm 1\%$ shunted by < 300 pF with low terminal grounded^{5,6}.

CMRR (@ 60 Hz): 60 dB for differential input $< 2\text{V}$; 36 dB for differential input $< 48\text{V}$; 30 dB for differential input $> 48\text{V}$.

Remote operation: HP-IB, all functions except the line switch, low terminal ground switches, and the $\times 10 \div 10$ increment keys.

HP-IB compatibility, as defined in IEEE-488-1978, is: SH1, AH1, T5, TE0, L3, LE0, SR1, RL1, PP0, DC1, DT1, C0.

Temperature: operating, 0° to 55°C; storage, -55°C to 75°C.

Power requirements: 100, 120, 220, or 240 volts (+5, -10%); 48-440 Hz; 100 VA maximum.

Weight: net, 12.3 kg (27 lb). Shipping, 16.4 kg (36 lb).

Size: 146 H x 425 W x 440 mm D (5.75 x 16.8 x 17.3 in.).

HP System II module size: 5/4 H x 1 MW x 17 D. See pp. 658-661 for compatible accessories.

EMI: conducted and radiated interference is within the requirements of methods CE03 and RE02 of MIL STD 461A, VDE 0871, and CISPR publication 11. Conducted and radiated susceptibility meet the requirements of methods CS01, CS02, and RS03 (1 volt/meter) of MIL STD 461A dated 1968.

Ordering Information

8903A Audio Analyzer

(Note: HP-IB cable not supplied. See page 38.)

Option 001: Rear panel connections instead of front panel for source output and analyzer input.

Option 907: Front panel handle kit

Option 908: Rack mount flange kit

Option 909: Front panel handle plus rack mount flange kit

Option 910: Extra Operating & Service Manual

³20 Hz to 100 kHz in SINAD and distortion.

⁴Resolution is limited to 0.01 Hz for input frequencies < 100 Hz.

⁵In dc level mode input resistance is 101k $\Omega \pm 1\%$.

⁶Input capacitance is < 330 pF for Option 001.

TRANSCIVER TEST EQUIPMENT

8955A RF Test System

537



- High performance measurements of AM and FM transmitters, receivers, and their modules
- Frequency range from 150 kHz to 1000 MHz
- System calibration, verification and diagnostics

- A fully automatic operating system with easy softkey interaction
- Automatic program generator
- Over 60 tests using EIA and CEPT standards

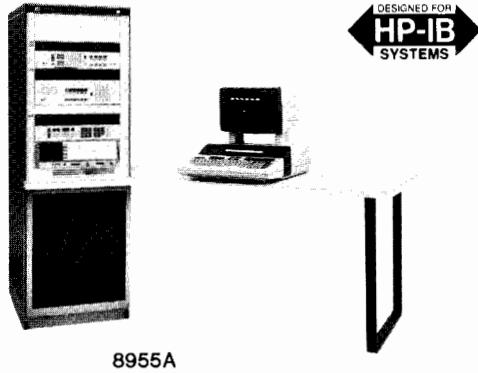

8955A

8955A RF Test System

The 8955A RF Test System is a flexible combination of instrumentation and software used in the testing of transmitters, receivers, and subassemblies. The basic system consists of three measurement instruments: 8901B Modulation Analyzer, 8903A Audio Analyzer and 8656A Signal Generator. To these instruments is added the 8956A System Interface to provide flexibility and easy system integration. The system is automated with a powerful software package that is executed on either the 9845B or Series 200, Model 16 or 36 Computer System. All hardware is mounted in a 29402C cabinet and a desk is mounted off one side.

11725A/11791A Software Packages

The 11725A Software Package for the 9845B or the 11791A Software Package for the 9816S or 9836S assure comprehensive transceiver testing on the same day the system is turned on. The software package is a powerful combination of operating system and measurement test routines. The operating system allows you to learn about system operation through its HELP command, verify system operation, reconfigure the system if new instruments are added or generate and execute a program from HP supplied test routines. While the test package is executing, you can interact with the system: halt execution to modify parameters, repeat certain tests, or learn more about system operation. There are over 60 measurement test routines which use the Electronic Industry Association (EIA) and Conference of European Postal and Telecommunications Administration (CEPT) standards for AM and FM receivers, transmitters, and their circuitry.

Additional software includes a powerful verification program, calibration program and configuration program which allows you to change the instrument configuration.

Options

The system offers a variety of options to meet your needs. These options include instrumentation for SSB testing, out-of-channel testing, spurious response testing, power supplies, and cabinet hardware. All options are fully supported and integrated at the factory. Comprehensive documentation is included with every system and installation is offered as an option.

Optional Instrumentation

8662A Synthesized Signal Generator
8568A Spectrum Analyzer
3325A Synthesizer/Function Generator
Second 29402C Cabinet
Sidebay
Second Desk

8955A SYSTEM SPECIFICATIONS (INCLUDES SOFTWARE CALIBRATION)

RF Signal Measurements (transmitter tests)

Frequency range: 150 kHz to 1000 MHz.

Frequency measurement accuracy: refer to 8901B.

Power Measurement Range

With the 30 dB attenuator: 50 mW to 120 W.

Without the 30 dB attenuator: 100 μ W to 0.5 W.

Power Measurement Accuracy

With the 30 dB Attenuator

Within 2 MHz of calibration frequencies: $< \pm 0.5$ dB (± 0.3 dB typical).

1 MHz to 1000 MHz: $< \pm 0.45$ dB typical.

Input VSWR

With the 30 dB attenuator

dc to 1000 MHz: ≤ 1.2 .

Modulation measurements (AM, FM, PM): refer to 8901B.

RF Signal Source (receiver tests)

Frequency range: 100 kHz to 990 MHz.

Option 112 or 122: 10 kHz to 1280 MHz.

Output Level Range

With the 30 dB attenuator: -27 dBm to -130 dBm.

Without the 30 dB attenuator: $+0$ dBm to -130 dBm.

Output Level Accuracy

With the 30 dB Attenuator

Within 2 MHz of calibration frequencies: $< \pm 1.8$ dB.

100 kHz to 990 MHz: $< \pm 1.5$ dB typical.

Option 112 or 122

Within 2 MHz of calibration frequencies: $< \pm 1.3$ dB.

10 kHz to 1000 MHz: $< \pm 1.1$ dB typical.

Output VSWR

With the 30 dB attenuator:

dc to 1000 MHz: ≤ 1.2 .

Modulation: refer to signal generator specifications.

Audio Measurements

Frequency range: refer to 8903A.

Voltage measurement range: 50 mV to 30 V.

Voltage measurement accuracy: refer to 8903A.

Distortion measurement: refer to 8903A.

Audio Source

Frequency range: 20 Hz to 100 kHz.

Output voltage range: refer to 8903A.

Output voltage accuracy: refer to 8903A.

Current drain measurement range: 0 to 30 A.

Current Drain Measurement Accuracy

$I < 10$ A: \pm (2.5% of reading + 12 mA).

$I > 10$ A: \pm (4% of reading + 12 mA).

Timing Measurements

Closure of relay to half RF power (Carrier Attack Time).

Application of an RF signal to 90% rated audio power (Receiver Attack Time).

Removal of an RF signal to squelch closure (Receiver Squelch Closing Time).

Timing accuracy: \pm 5 msec typical.

Timing interval: 500 msec maximum

Timing resolution: 0.1 msec.

General Specifications

System operating temperature: 15° to 35° C.

System storage temperature: -40° to $+75^\circ$ C.

Ambient humidity: 5% to 80%.

Power: 115 V, 60 Hz; Standard system w/9845B:

Approximately 900 VA worse case.

Net weight (less controller): 150 kg (330 lb).

Shipping weight (less controller): 212 kg (467 lb).

Cabinet dimensions: 163 cm H x 53 cm W x 70 cm D (64.25" x 21.0" x 27.6").



TRANSCIVER TEST EQUIPMENT

Transceiver Test Set

Model 8953A

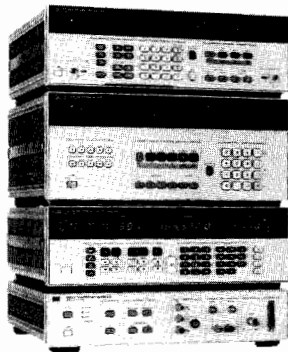

Description

The 8953A Transceiver Test Set performs automatic and manual in-channel testing of AM and FM communication receivers and transmitters from 150 kHz to 990 MHz. It combines the measurement power of the 8901A Modulation Analyzer, 8903A Audio Analyzer and 8656A Synthesized Signal Generator with the 8954A Transceiver Interface, all necessary cables, accessories and software for a choice of controllers: the 85B, 9816S, 9826S or 9836S Computer Systems.

Flexible and Expandable

Together these instruments and controllers provide a broad range of measurement capability from simple tests such as RF frequency and distortion through complex measurements including receiver usable sensitivity and audio frequency response. Basic in-channel testing of a radio using the test set's 11723B or 11790A Application Pac software typically takes less than a minute. These application pacs, the 11723B for the 85B and the 11790A for the 9816S, 9826S and 9836S, are comprehensive starter/demonstration software programs written in BASIC language. They are modular in structure and easily customized for specific applications.

For those requiring additional measurement capability such as out-of-channel or SSB testing, the test set's 8954A interface has connections for a second signal generator, a second RF monitor such as a power meter or a spectrum analyzer, and a d.c. power supply.

Option 100

This option substitutes the more powerful 8956A System Interface for the standard 8954A Transceiver Interface, adding capabilities including current drain and transmitter and receiver attack time measurements. The 11790B Application Pac which takes advantage of the added capabilities of the 8956A can be executed on the Series 200 controllers.

Easy to Operate

The 8953A test set is easy to use in both automatic and manual operation. Full front panel control, plus indicators for all functions, make test program development easy. Procedures can be developed manually and then translated to the controller's BASIC language by simply substituting one- or two-character program codes for keystrokes. For example, the keystroke sequence "Frequency 455 MHz" is equivalent to the program code "FR455MZ".

Easy to Assemble

Assembling the test set is quick and easy. The 8953A Operating Manuals describe the simple setup procedure, provide a method for verifying setup, and describe how to use the supplied 11723B/11790A/11790B Application Pac software. You need to provide a power supply for the transceiver under test, and cables between the 8954A Transceiver Interface and the transceiver. Everything else is included.

Receiver In-channel	Transmitter	General
Sensitivity*	Power*	AC Volts
Audio Power*	Frequency*	DC volts
Signal-to-Noise*	Frequency Error*	Frequency
Distortion*	AM, FM, \emptyset M	Distortion
SINAD	Squelch Frequency*	
Quieting	Squelch Deviation*	
Audio Freq. Response*	Residual AM, FM or \emptyset M	
Hum and Noise	Incidental AM, FM or \emptyset M	
Receiver Out-of-Channel	Microphone Sensitivity*	
Adjacent channel selectivity**	Distortion*	
Image rejection**	Modulation Limiting*	
IF rejection**	Audio Freq. Response	
	Hum and Noise*	
*Tests performed and displayed by the 11723B/11790A/11790B Application Pac program. Additional subroutines are provided for all the measurements.		**Additional tests performed and displayed using the 11723B/11790A/11790B Application Pac program if an 8662A Signal Generator is added to the test set for out-of-channel testing.

The 8953A can be configured with controllers and computer peripherals to form a complete system.

Ordering Information

8953A Transceiver Test Set

8901A Modulation Analyzer

Option 001 Rear Panel Connections

Option 002 High Stability Time Base

8656A Signal Generator

Option 002 Rear Panel Connections

8903A Audio Analyzer

Option 001 Rear Panel Connections

8954A Transceiver Interface

8498A Option 030 Attenuator, 25 watt, 30 dB

10833A Low-RFI HP-IB Cables (3)

11500B 60 cm N Cables (2)

11170A 30 cm BNC Cable

11170B 60 cm BNC Cables (2)

11170C 120 cm BNC Cables (2)

908A 50-Ohm Termination

Option 100: adds 8956A System Interface; deletes 8954A Transceiver Interface, 8498A Attenuator, and 908A Termination

11723B Application Pac

11790A Application Pac

11790B Application Pac

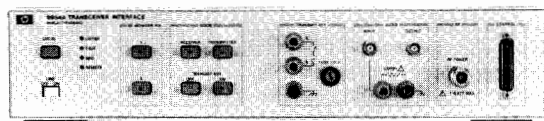

8954A

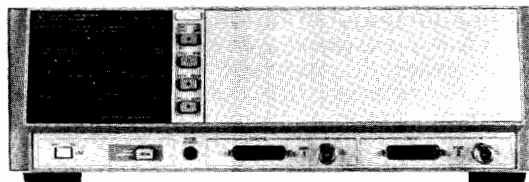

8956A

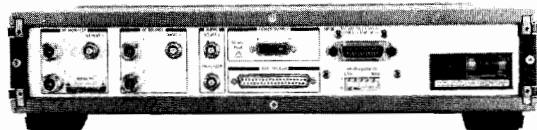

8954A Rear View

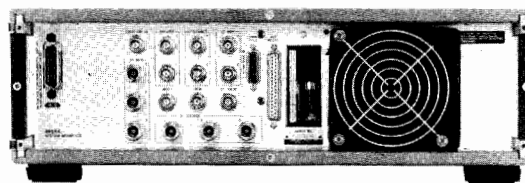

8956A Rear View

8954A Transceiver Interface

The 8954A is Hewlett-Packard's lowest priced transceiver test interface. It is fully programmable and designed for dc to 18 GHz measurement applications.

The 8954A interface has connections for the three measurement instruments; the 8901A or 8901B Modulation Analyzers, 8903A Audio Analyzer and 8656A Signal Generator. You can add a second signal generator, a second RF monitor such as power meter or a spectrum analyzer, and route a power supply's output through the interface to the front panel transceiver connector. External devices may be controlled with the 8954A's sixteen programmable form-A contact relays.

Using the annunciated front panel keys, you can manually control the Receive/Transmit signal path, select either RF monitor, or key the transmitter. The 8954A Transceiver Interface provides the flexibility needed for most AM, FM and SSB receiver and transmitter testing.

8954A Specifications

RF frequency range: 100 kHz to 1300 MHz. (usable dc to 18 GHz.)

VSWR (RF Port to RF Monitor): ≤ 1.15

VSWR (RF Source to RF Port): ≤ 1.15

RF insertion loss: (RF Port to RF Monitor) ≤ 0.5 dB

RF Insertion loss: (RF Source to RF Port) 6.0 dB +0.45 dB -0.35 dB

Audio frequency range: 20 Hz to 100 kHz. (dc coupled)

Audio insertion loss: 0.03 dB, 20 Hz to 20 kHz. 0.3 dB, 20 kHz to 100 kHz.

Supplemental Characteristics

DC Power Supply Circuit

Current: 30A (Voltage < 28 Vdc)

Voltage: 50 Vdc (Current < 15 A)

Transmit Key Relay

Current: 1.5A (Voltage < 28 Vdc)

Voltage: 50 Vdc (Current < 0.5 A)

Auxiliary Relays (16 Form-A contact)

Current: 0.5A (Voltage < 20 Vdc)

Voltage: 50 Vdc (Current < 0.2 A)

Ordering Information

8954A Transceiver Interface

8956A System Interface

The 8956A System Interface, with its multiple paths and connections, provides flexibility in the designing of systems in the frequency range from dc to 1000 MHz. It can integrate up to 3 signal generators, 3 RF measurement instruments, 2 audio sources, 2 audio measurement instruments and a dc power supply.

A front panel keyboard makes it easy to control all switching operations making it a valuable component in system integration. Store/Recall keys of the front panel settings give extra versatility in manual operation.

The 8956A System Interface has 2 RF test ports for duplex testing, stimulus/response testing or for connect/unconnect of one unit under test while another is being tested. Next to each RF port is a control connector that contains all the audio and power signals.

Other additional functions of the 8956A include current drain and timing measurements.

8956A Specifications

Frequency range: dc to 1000 MHz

Maximum Input Power to RF Ports

With the 30 dB attenuator: 120 W CW

Without the 30 dB attenuator: 0.5 W CW

VSWR

RF Ports: (Instrument connections terminated in 50 ohms):

With the 30 dB attenuator: dc to 1000 MHz: ≤ 1.2

Audio

Frequency Range: dc to 100 kHz

Supplemental Specifications

Insertion Loss

Maximum variation of insertion loss with frequency: < 5 dB.

Insertion loss of major RF source and monitor paths with the attenuator inserted can be characterized by: $A(\text{dB}) = A_0 + k\sqrt{f}$
 A_0 = Loss at dc, k = Constant, f = Frequency (MHz).

Ordering Information

8956A System Interface

Option 001 Rear Panel RF and Control Ports

TELECOMMUNICATIONS TEST EQUIPMENT

Digital Communications Measurements

Introduction

Digital networks have advanced rapidly from the early days when junction PCM systems were used to increase inter-exchange capacity between switching centres. Key to this has been the development of integrated digital switching and transmission systems and the impact of technology, particularly in the area of codecs and subscriber line interface circuits. This trend towards Integrated Digital Networks (IDN's) and Integrated Services Digital Networks (ISDN's) has resulted in new testing needs and increased emphasis on characterising performance of PCM conversion equipment and digital transmission links.

PCM Conversion Measurements

Today's IDN's are almost exclusively based on 64 kb/s PCM voice channels to one of two coding standards, CEPT A-law or Bell μ -law, both of which are now standardised by the CCITT. These coding standards both use 8 kHz speech sampling and 8-bit PCM companding to achieve high quality digitised voice transmission through 64 kb/s circuit-switched digital exchanges. Circuits can also carry multiplexed low-speed or wideband high-speed data with the result that future networks will carry a mixture of voice and data services via digital transmission systems. Initially, the majority of data carried by IDN's will be "conventional" analog modulated data from modems at customer's premises which is then PCM encoded at the nearest serving exchange switching centre. In addition to dial-up data circuits through digital switches, an increasing number of leased non-switched circuits are provided at least in part, if not completely, via PCM transmission systems between switching offices.

These developments have resulted in an increased demand for measurements in the PCM signal of parameters affecting both voice and data services. This is especially true for automatic remote test systems such as the checking of circuits provided via digital access and cross-connect systems. The key to testing these circuits is the ability to

measure PCM voice and analog data transmission performance at both analog and digital access points i.e. in a mixed analog/digital network. HP's current range of PCM test equipment has been strengthened and expanded considerably by the introduction last year of the 3776 PCM Terminal Test set. This powerful new instrument can make both PCM voice and analog data measurements in both analog and digital domains.

The 3776 has also made significant advances in the field of PCM measuring technology by implementing most of the measurements using digital signal processing. The instrument includes a sophisticated bit-slice processor generator for the PCM frame and digitally generated stimuli, and a programmable digital filter for the range of complex filters required in PCM measurements. This technological contribution allows more comprehensive measurement capability to be integrated into a smaller, lower cost, more portable package than previously possible. When coupled with HP's computational products, the 3776 becomes a powerful system component of automated remote access and test systems for monitoring and maintaining mixed analog/digital networks.

TDM Transmission Measurements

Digital transmission over cable, radio, satellite and, more recently, optical fibre is becoming an increasingly large proportion of inter-exchange and long haul transmission. As IDN's evolve and other services are added into the ISDN concept, transmission measurements have shifted from basic measures of bit error ratio and peak-peak jitter towards more thorough analysis of systems in terms of error performance or distribution with time. There is an increasing emphasis on evaluating "availability" of digital circuits. This requires more powerful analysis capability to be built into test instrumentation and the possibility of collecting large amounts of data for evaluation off-line in computers. HP is uniquely placed with advanced measuring and computational tech-

nology to provide measurement solutions for these needs. A comprehensive range of error and jitter performance test equipment is now available covering bit rates from 1 kb/s to 170 Mb/s. Many special features are included for the three principal IDN digital transmission hierarchies now standardised by the CCITT.

The latest and most powerful instrument is the 3764A Digital Transmission Analyzer which is specifically designed for error and jitter performance measurements on 140 Mb/s links. Built-in analysis of availability and error distribution with real time are provided together with a choice of printer or cassette data capture media. An option of the instrument provides error performance testing and interfacing at the four standard bit rates of the CEPT digital hierarchy. Full HP-IB control also makes this instrument a powerful tool in automated production testing or digital network maintenance.

Jitter and Digital Networks

The increasing interest in and significance of timing jitter in digital networks has made this parameter of key importance in PCM/TDM measurements. This phenomenon has not been well understood until relatively recently, but is now recognised to be a major source of errors and other transmission impairments. HP offers a comprehensive range of jitter testing capability based on the 3785 Jitter Generator & Receiver for bit rates up to 50 Mb/s, and the 3764A Digital Transmission Analyzer for 140 Mb/s. Ease-of-use features such as built-in jitter tolerance mask sweeping and full HP-IB control make these instruments powerful tools in production test and field trial situations. A loop timing measurement in the 3776 PCM Terminal Test Set provides a quick field check of the most common causes of digital switching machine malfunction when working to loop-timed PCM multiplexers/channel banks.

Read on for a more detailed look at the comprehensive range of HP products for digital communications applications.

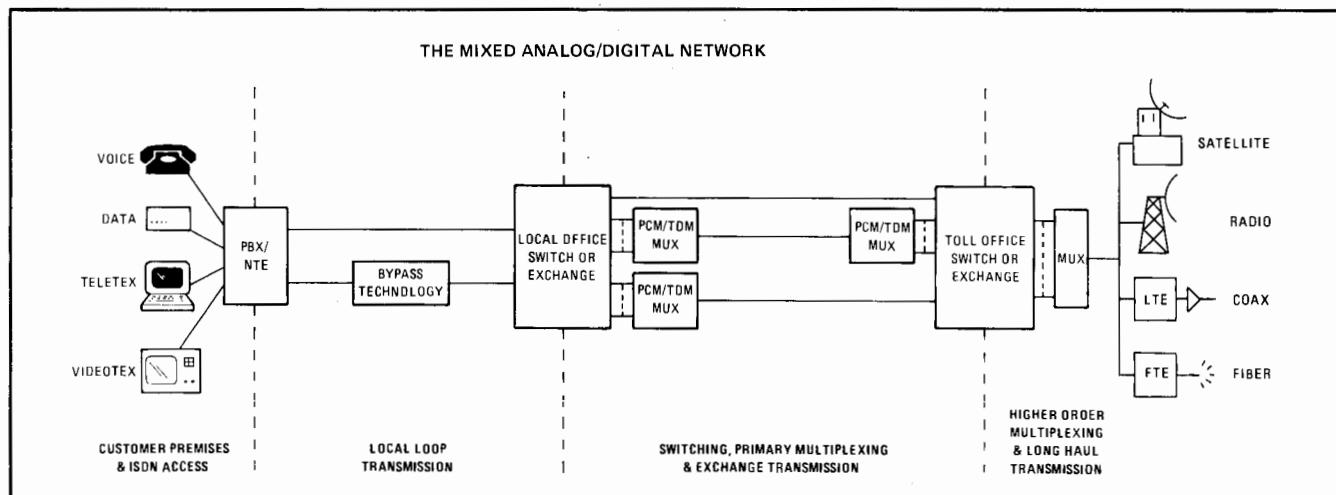

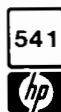

- Analog and digital interfacing in CEPT/Bell/Japanese/CCITT networks
- Provides voice, PCM and data measurements in one instrument
- Direct output to printer or plotter

- Simple measurement sequencing
- Full A-A, A-D, D-A, D-D measurement modes
- Built-in self test and measurement checking

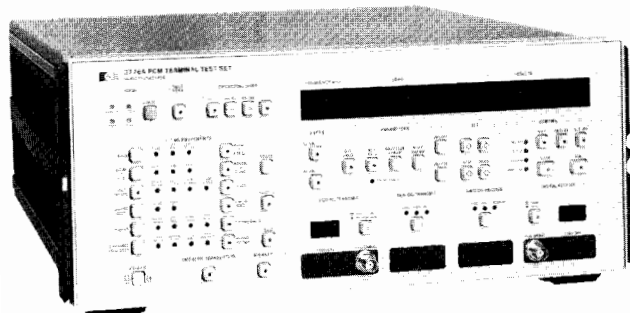

3776A

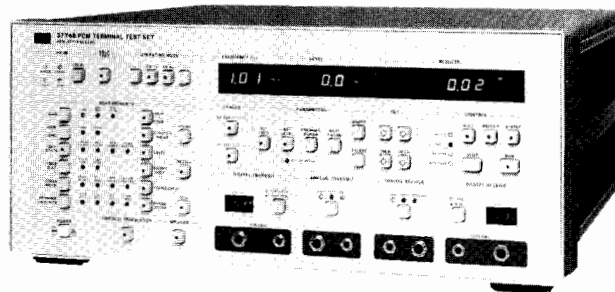

3776B



The 3776A/B PCM Terminal Test Set interfaces directly at the analog and digital level in mixed analog/digital networks. The 3776A is designed for CEPT/CCITT compatible networks while the 3776B is suitable for North American/Japanese/CCITT networks. Used in installation, commissioning and maintenance, the 3776A/B ensures optimum performance for each section (e.g., PCM channel bank, digital switching system or transmultiplexer) of the network.

One Instrument for Voice and Data Services

The 3776A/B provides comprehensive voice, PCM and data measurements for testing 4 kHz bandwidth analog and digital channels. It replaces the collection of independent analog and digital test equipment previously used in a mixed system environment with one compact instrument. Facilities included are:

- Voice and PCM measurements in A-A, A-D, D-A or D-D modes
- Framing and signalling bits setting and monitoring.
- Data measurements - on analog and digital circuits.

A summary of the measurements available is shown below:

Standard Measurements	A-A	A-D	D-A	D-D
Gain	•	•	•	•
Digital mW gain	•	•	•	•
Level (including harmonic distortion)	•	•	•	•
Gain v level (using tone)	•	•	•	•
Gain v level (using noise - 3776A)	•	•	•	•
Gain v level (using sync 2 kHz)	•	•	•	•
Gain v frequency	•	•	•	•
Idle state (choice of filters)	•	•	•	•
Coder offset and peak codes	•	•	•	•
Noise with tone	•	•	•	•
Quantizing distortion (using tone)	•	•	•	•
Quantizing distortion (using noise - 3776A)	•	•	•	•
Intermodulation (using two tones)	•	•	•	•
Intermodulation (using four tones - 3776B)	•	•	•	•
Digital Tx/Rx	•	•	•	•
Return loss 4W (ERL - 3776B)	•	•	•	•
Loop timing check	•	•	•	•

Optional Data Measurements	A-A	A-D	D-A	D-D
Group delay distortion (3776A)	•	•	•	•
Envelope delay distortion	•	•	•	•
Absolute delay	•	•	•	•
Phase jitter (choice of filters)	•	•	•	•
Transients (measured simultaneously):	•	•	•	•
Amplitude/gain hits	•	•	•	•
Phase hits	•	•	•	•
Interruption/dropouts	•	•	•	•
Impulse noise (3 levels)	•	•	•	•

Isolate Problems Quickly and Minimize Downtime

The 3776A/B provides convenient features to help reduce measurement set-up time. Hence more time can be spent isolating problems and restoring service with minimum downtime. These features are:

- Pre-programmed default measurement parameters.
- User-modified measurement parameters held in non-volatile memory.
- Measurement sequences can be downloaded from a controller to the 3776A/B and run independently.

Results Management

Measurement parameters and results are output directly to a printer or plotter via the HP-IB. Printed results are in a systematic, tabular format for easy analysis. In plot mode, multipoint measurement results are presented in a neat graphical format. Performance discrepancies can be spotted easily.

Features for Tomorrow's Networks

The 3776A/B has been designed keeping in mind the needs of tomorrow. Unique facilities provided for future use are:
 3776A - Selection of 30 or 31 voice channel testing
 3776B - Bell extended superframe (ESF) format & B8ZS line coding

Specifications Summary

Full information and specifications are contained in the 3776A/B Data Sheet and 3776A/B Specifications Booklet.

Supply voltages: 115/240V ac +10%, -22%

Power consumption: 85W nominal

Size: 178 H x 425 W x 440 mm D (7 x 16.75 x 17.25 in).

Weight: 15 kg (33 lb)

Temperature range: operating 0° to 55°C
 storage -40° to 75°C

3776A Options

001 - Adds data measurements.

002 - Replaces digital interface BNC connectors with 75 ohm Siemens 1.6/5.6 mm coaxial.

3776B Options

001 - Adds data measurements.

002 - Japanese measurement and connector requirements

004 - Interface connectors on standard instrument replaced by Trompeter triaxial type BJ77 located on rear panel.

Common Options

Local language operating booklets (see Data Sheet)

801 - Front panel cover (not available with front handle & rack flange options 907, 908, 909)

910 - Extra set of manuals

Ordering Information

3776A PCM Terminal Test Set

3776B PCM Terminal Test Set



TELECOMMUNICATIONS TEST EQUIPMENT

Primary Multiplex Analyzer; PCM Test Systems

Models 3779C, 3779D

- A-A, A-D, D-A and D-D measurements
- Automatic measurement sequencing
- CCITT, CEPT, and Bell compatible

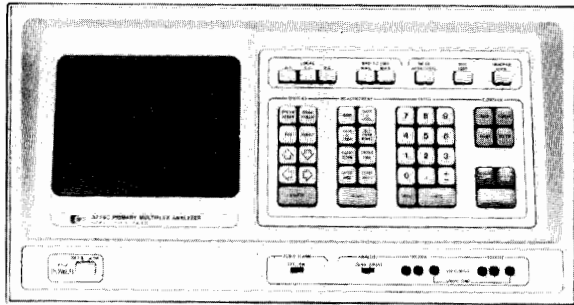

3779C



The 3779C Primary Multiplex Analyzer (PMA) provides voice channel measurements to CEPT recommendations. The digital options are designed to test PCM equipment conforming to CCITT Recommendations G.711 and G.732, i.e., 30 voice channels/32 time slots encoded using the A-law and multiplexed into a 2048 kb/s stream. A single channel TTL compatible interface is available for codec and digital line card testing where clock and sync signals are separate from the PCM data.

Model 3779D provides voice channel measurements to Bell recommendations. Digital options 001 and 003 are designed to test PCM equipment conforming to BSTR Pub 43801 and CCITT Recommendations G.711 and G.733, i.e., 24 voice channels/24 time slots encoded using the μ -law and multiplexed into a 1544 kb/s stream. A single channel TTL compatible interface is also available on all options and is used exclusively on option 002 for μ -law systems operating at 2048 kb/s.

The 3779C/D permits rapid, accurate, automatic testing of voice channel and primary level digital equipment, the main applications being in the areas of PCM terminals, codecs, and other specialized telecommunications IC's or hybrid devices, and digital switching systems, especially line card testing.

The instrument can automatically sequence through a number of measurements to programmed limits, calculate and output results on an alphanumeric CRT display. All measurement execution software is preprogrammed into the instrument, but test levels, frequencies, limits, etc. may be keyboard-modified if required. Measurements may be assembled into a sequence which is stored in non-volatile memory.

The PMA is itself a system controller, containing operating software for a system comprising a printer and up to nine 3777A Channel Selectors. However, versatile as the PMA is, some users may require more. A PMA subsystem may then form part of a larger automatic test system incorporating, for example, power supplies, DVM's, switches, etc.

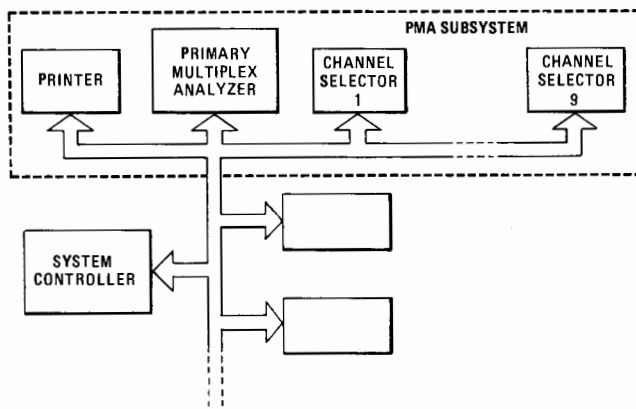

- User-level keyboard programming
- Non-volatile program store
- Direct control of Channel Selectors

The following examples are just a few of the ways in which the PMA capability can be enhanced by using an external system controller.

- Identification and analysis of worst-case channels.
- Statistical analysis and graphical display of results
- Production test stations using PMA's can be controlled from a centralized computer system. This can be used to give increased throughput of specialized communications equipment, e.g., codecs and digital line cards.

Measurements

The standard 3779C/D provides A-A (analog-analog) and E-E (end-end) measurement capability. A-D (analog-digital), D-A (digital-analog), and D-D (digital-digital) capabilities are optional.

Measurements	A-A	A-D	D-A	E-E
Gain	•	•	•	•
High accuracy gain	•			
Digital mW gain			•	
Gain vs frequency	•	•		•
Gain vs level using noise (3779C only)	•	•	•	•
Gain vs level using tone	•	•	•	•
Gain vs level using sync 2 kHz			•	
Coder offset		•		
Peak codes		•		
ICN weighted, 3 kHz flat & selective	•	•	•	•
Noise with tone	•	•	•	•
Quantizing distortion using tone	•	•	•	•
Quantizing distortion using noise (3779C only)	•	•	•	•
Intelligible crosstalk	•	•	•	•
Intermodulation using two tones	•	•	•	•
Intermodulation using four tones (3779D only)	•	•	•	•
Discrimination against out-of-band inputs	•			•
Spurious out-of-band outputs	•			•
Spurious in-band outputs	•	•	•	•
Return loss using swept tone (Tx & Rx)	•			
Impedance balance (Tx & Rx)	•			
Signal balance	•			•
E & M signalling distortion	•			•
Tx-Rx	•	•	•	

In addition, facilities are available on the 3779C to test automatically the multiplex alignment and alarm strategy.

Options (3779C)

001: provides A-D, D-A, and D-D hardware and software; 2048 kb/s PCM interfaces are ternary rectangular with 75 Ω BNC connectors

002: as Option 001 except PCM and clock connectors are 75 Ω Siemens 1.6/5.6 mm

003: as Option 001 except PCM and co-directional clock connectors are 120 Ω Siemens 3-pin

Options (3779D)

001: provides A-D, D-A, and D-D hardware and software; 1544 kb/s PCM interfaces are bipolar rectangular with 100 Ω balanced WECO connectors

002: provides A-D, D-A, and D-D hardware and software for μ -law systems operating at 2048 kb/s; digital connections are via single channel interfaces only

003: as Option 001 except PCM and clock connectors are BNC 75 Ω

Ordering Information

3779C Primary Multiplex Analyzer (CEPT)

3779D Primary Multiplex Analyzer (Bell)

TELECOMMUNICATIONS TEST EQUIPMENT

HP-IB Controlled Channel Selector; 2Mb/s Frame Alignment Monitor

Models 3777A, 3783A

543



3777A

- DC to 110 kHz
- 2-wire/4-wire balanced switching
- Modular construction
- Up to 30 4-wire channels

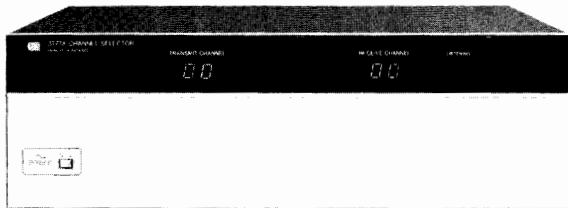

3777A



3783A

- Provides in-service error monitoring on 2 Mb/s systems
- Counts frame or code errors
- Low-cost, portable unit
- Optional rechargeable battery

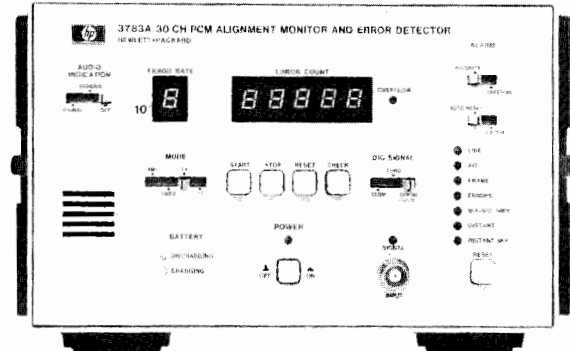

3783A

3777A Channel Selector

The 3777A is an HP-IB controlled Channel Selector. It provides test point access for maintenance and production testing of PCM and FDM telecommunications systems.

The instrument contains two identical banks of relays, termed 'Transmit' and 'Receive.' Each bank comprises up to 30 balanced, bi-directional, two-pole changeover switches. The Transmit bank enables switching of a single source to any one of up to 30 outputs. In the Receive bank, any one of up to 30 inputs can be switched to a common output. To provide a quiet termination for telecommunications equipment, all unselected channels are terminated in 600 Ω in series with 2.2 μ F. Alternative impedances can be provided on request.

The two switch banks are controlled independently via the HP-IB from the 3779 Primary Multiplex Analyzer, a computer or a programmable calculator. For automatic test systems, the 3777A can scan, under external program control, through a number of channels in any desired sequence.

For applications requiring more than 30 channels, several 3777A's can be connected in a switch array. Other configurations can be realized by the appropriate interconnection of the Transmit and Receive bank inputs and outputs.

Construction of the 3777A is modular, with the 30 channels in both Transmit and Receive banks arranged in 5 blocks, each block having 6 Transmit and 6 Receive channels. 12 and 24 channel versions with only 2 or 4 blocks are available as options.

Principal applications are in testing telecommunications equipment where the 3777A may be used to switch PCM primary multiplex channels, FDM voice channels or groups, and voice frequency telegraph circuits, for measurements during production, installation, or maintenance. The high quality relays employed in the 3777A also make it suitable for many other general purpose applications requiring an HP-IB controlled channel selector.

3777A Options

001: 24 channels in transmit and receive banks. WECO 310 connectors used for transmit I/P and receive O/P.

002: 12 channels in transmit and receive banks. Siemens audio connectors used for transmit I/P and receive O/P.

003: 12 channels in transmit and receive banks. WECO 310 connectors used for transmit I/P and receive O/P.

3777A Channel Selector

3783A 30 Ch PCM Alignment Monitor and Error Detector

The 3783A is a low-cost, portable instrument for in-service measurements on 2 Mb/s digital transmission systems conforming to CCITT Recommendation G.732 (European CEPT, 30 channel PCM multiplex standard). The instrument can detect and count:

- Frame alignment signal errors
- Code violation errors
- External input error pulses from a multiplex

Frame alignment signal (FAS) errors are measured by decoding the HDB3 2 Mb/s line signal and recovering the time slot allocated to the framing signal, TS0, from which errors occurring in the FAS can be detected and counted. Display of the measured result can be a binary bit error rate, based on the assumption that the overall signal contains a Poisson distribution of errors, or a FAS error count over a manually selected measurement period. While operating as a FAS error detector, the instrument also detects and displays any system alarm states which are carried in TS0 and TS16, the time slot allocated to signaling. These alarm states can be displayed on a priority or free run basis with a latch/auto-reset facility.

In addition to monitoring FAS errors, the 3783A can check the input line signal for code violation errors according to the AMI or HDB3 encoding rule. The instrument can also count low frequency input pulses such as the error output signal found on some digital transmission equipment.

The 3783A can be attached in terminated mode to the output of an equipment (out-of-service measurement) or in monitor mode to the high impedance monitor point provided on digital transmission equipment (in-service measurement). An optional rechargeable battery pack allows portable field use where normal station ac main supplies are unavailable. An audio indication of signal present or detection of errors can be selected.

Options

001: operation from rechargeable battery pack.

002: 120 Ω balanced input; 3 pin Siemens connector.

3783A 30 CH PCM Alignment Monitor and Error Detector

TELECOMMUNICATIONS TEST EQUIPMENT

1 kb/s/50 Mb/s PCM/TDM Error Measuring Set for Field Use

Model 3780A

- Binary and code error measurements
- Internal crystal clocks and clock recovery
- Clock frequency offset generation and measurement
- Ternary coded and binary interfaces
- PRBS and WORD pattern generation and detection
- Printer and recorder outputs

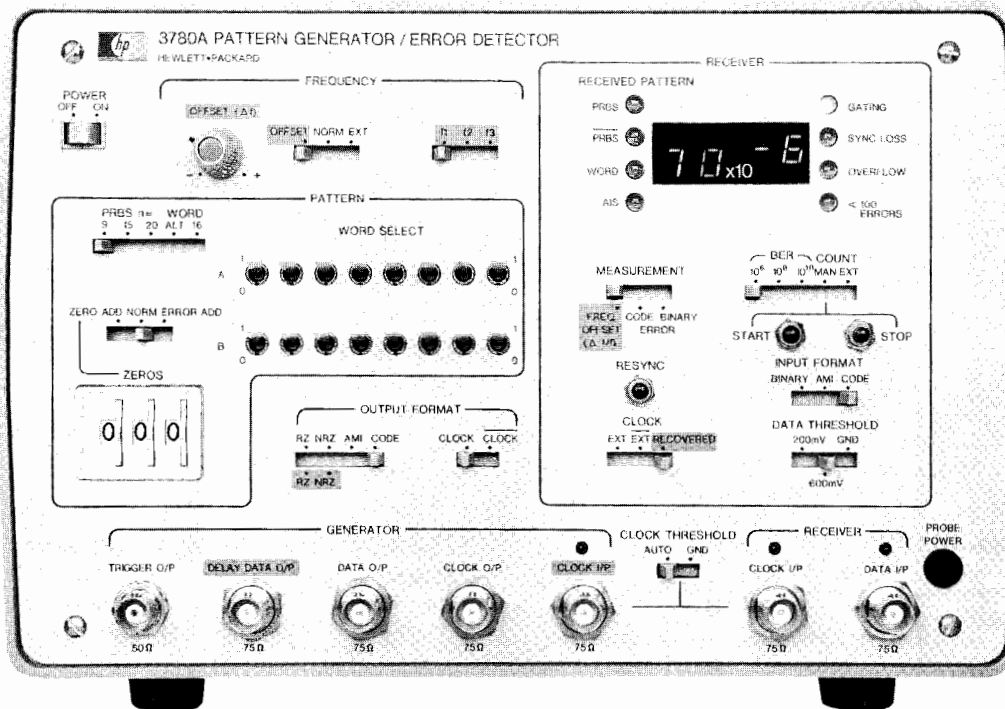

3780A
Option 001

The 3780A Pattern Generator/Error Detector is a comprehensive error measuring set in one portable package. The instrument measures Binary Errors and Code Errors in digital transmission equipment operating at bit rates between 1 kb/s and 50 Mb/s. Frequency offset generation and measurement are also provided at the standard bit rates used in PCM/TDM transmission.

Binary errors are detected by stimulating the system with a test pattern and comparing the output bit-by-bit with a separate internally generated, error-free pattern. Code errors on interface or line coded information are detected during decoding into binary data. The errors can be counted over a chosen gating period and displayed directly as bit error ratio (BER) or total error count (COUNT).

Error measurements can be made with PRBS or WORD patterns and the receiver has automatic pattern recognition and synchronization. Alternatively, the reference pattern can be preset by the pattern switch which allows detection of systematic pattern errors. Zero add facilities allow investigation of regenerator clock recovery performance. This capability can be extended by the optional addition of programmable word and alternating word generation.

The clock frequency in the pattern generator can be offset and measured in the receiver. The offset is displayed as a fraction of the nominal crystal centre frequency. In addition, the offset of external clocks applied to the generator can be measured provided that the frequency is within 25 kHz of one of the installed crystal frequencies.

BER or COUNT results can be displayed directly by LED's on the front panel or monitored via a BCD printer and strip chart recorder. This makes the 3780A ideally suited for unattended long-term measurements. Monitoring, display, and recording of the Alarm Indication Signal (AIS) is now included.

The 3780A has been designed principally for use in field trials, commissioning, and maintenance of digital transmission terminal and link equipment. A new option has been added which provides 2²³-1 pattern capability and automatic equalization for in-station cabling for 2, 8 and 34 Mb/s systems.

Specifications

Measurements

Binary errors: closed loop bit-by-bit detection on any pattern produced by generator, excluding added zeros or alternating words.

Code errors: violations of coding rule detected on any pattern with AMI, HDB3, or HDB2 coding (optionally AMI, B6ZS, or B3ZS).

Frequency offset: measurement of fractional offset of generator clock output from installed crystal rates.

Options

Word/Connector Options

- 001:** all words replaced by a 16-bit front panel programmable word
- 002:** Siemens 1.6 mm connectors
- 003:** combination of 001 and 002

Frequency Offset Option

099: frequency offset—measurement only; frequency offset generation deleted

Frequency/Codec Options

- Std:** internal clock frequencies of 2048, 8448, and 1536 kHz; HDB3/HDB2 codec.
- 100:** internal clock frequencies of 2048, 8448, and 34368 kHz; HDB3/HDB2 codec.
- 101:** internal clock frequencies of 1544, 6312, and 44736 kHz; B6ZS/B3ZS codec.
- 102:** internal clock frequencies of 1544, 6312, and 3152 kHz; B6ZS/B3ZS codec.
- 103:** internal clock frequencies of 2048, 8448, and 34368 kHz; 2²³-1 pattern replaces 2⁹-1; HDB3 codec.

3780A Pattern Generator/Error Detector

TELECOMMUNICATIONS TEST EQUIPMENT

Dedicated PCM/TDM Error Measuring Sets

Models 3781A, 3782A, 3781B, 3782B

545



3781A/B

- Versatile selection of test patterns
- Internal jitter modulation
- Additional delayed data output

3782A/B

- Binary and code error measurements
- Error ratio, error count, error seconds and error-free seconds displayed
- Powerful error distribution analysis

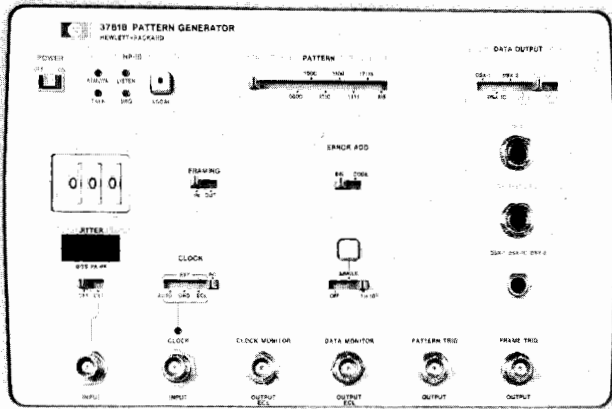

3781B

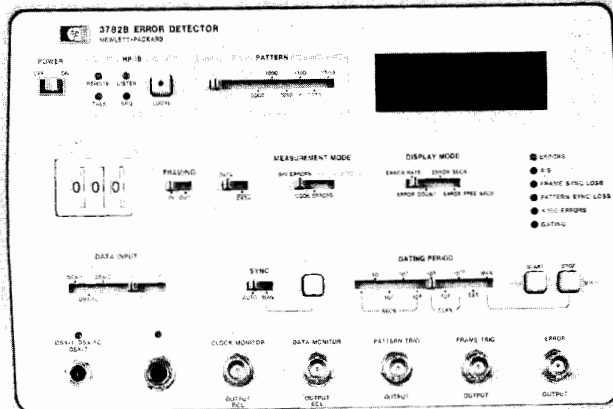

3782B



The 3781A Pattern Generator and 3782A Error Detector form a high performance error measuring system which complements the existing 3780A Pattern Generator/Error Detector. Designed to conform with CEPT and CCITT standards, the 3781A/3782A provide four bit rates (up to 50 Mb/s) of the digital hierarchy in one compact system. Applications of the system are in R&D, field trial and production testing, especially where an automatic and remote measurement capability via the HP-IB is required.

In the 3781A, binary or code errors can be injected as single shot or at 10^{-3} or 10^{-5} rates into a wide range of PRBS and 16-bit WORD test patterns coded in AMI or HDB3. The test patterns provided include standard 2^9-1 , $2^{15}-1$, and $2^{20}-1$ bit PRBS to CCITT Recommendations, fully programmable 16-bit WORD, and two 8-bit WORDS which may be alternated under the control of an external signal. Zero substitution (up to 120 zeros) for PRBS patterns is included to examine, for example, the clock recovery performance of regenerators. 75 Ω unbalanced and 120 Ω balanced pseudo-ternary outputs and binary TTL monitor outputs are provided. A jitter modulation input facility is provided for simple oscillator connection, with direct LED display of pk-pk bits of jitter. This can be used to measure the input jitter tolerance of digital transmission equipment. A second data output with 12 bits delay provides adequate simulation of an independent sequence for thorough testing of 4 ϕ PSK digital radio systems. As an option, four extra data outputs coded in AMI or HDB3 can be included on the rear panel for driving adjacent radio channels.

The 3782A detects binary or code errors which can be displayed in the form of error ratio, error count, error seconds, and error-free seconds over a wide choice of gating periods. All four results are computed simultaneously over the same gating period. For ease of use there is a built-in automatic check for compatibility of switch position combinations. An error code flashes on the display if incompatibility is detected. When the monitor mode is used, the 3782A can be used for in-service monitoring of digital transmission links.

Measurement results are available on the HP-IB and a rear panel result threshold switch allows pre-selection of an error threshold above which results will be printed. This provides useful data reduction and a first order error distribution analysis. With a built-in real-time clock, results can be output with time, if required.

The 3781B Pattern Generator and 3782B Error Detector form a dedicated error measurement system for testing and evaluating the performance of Bell digital transmission terminal and link equipment, up to and including the DS-3 level in the digital hierarchy. The 3781B/3782B can be used in production testing, field installation, and maintenance of the Bell digital transmission system, including PCM/TDM transmission over cable, radio, satellite, and fibre optic links. The principal application is at the DS-3 level in the Bell digital hierarchy.

The 3781B/3782B are designed to interface at Bell System standard cross connect points with appropriate ternary coding and interface voltage levels at each hierarchical level. Interfacing at the DS-1C and DS-2 levels is limited to T1-C and T2 line systems. At the DS-3 level, a choice of four data formats is available. Alternatively, binary ECL interfaces can be used.

The 3781B Pattern Generator provides a selection of standard 2^9-1 , $2^{15}-1$, and $2^{20}-1$ bit PRBS and fixed WORD test patterns with a choice of single error or 1 in 10^5 error simulation on the digital data stream for normal measurements and troubleshooting. A pattern of 17 ones/15 zeros and zero substitution (up to 999 zeros) for PRBS patterns are included to examine phase sensitive circuitry such as clock recovery of regenerators. A jitter modulation input facility is provided for simple oscillator connection, with direct LED display of pk-pk bits of jitter. This can be used to measure the input jitter tolerance of digital transmission equipment. A second DS-3 output channel with 22 bits delay provides adequate simulation of an independent sequence for thorough testing of 4 ϕ PSK digital radio systems. As an optional extra, four DSX-3 BNC outputs on the rear panel can be included for driving adjacent radio channels.

The 3782B Error Detector detects any binary or code errors generated by the system under test. At the DS-3 level, it can perform in-service or out-of-service measurements of parity errors within the digital transmission system. The 3782B can measure simultaneously error rate, error count, error seconds, and error free seconds over a single gating period. When the DS-3 MON facility is used, in-service measurements (eg parity errors) of live traffic are possible. For ease of use, there is a built-in automatic check for compatibility of switch position combinations. An error code flashes on the display if incompatibility is detected. Hard copies of results can be obtained on a printer via HP-IB control, either in the "talk-only" or "addressable" modes. In addition, a preselectable error rate threshold and a real time clock allows selection for printing results which exceed a defined threshold (with local time, if required).

Ordering Information

3781A Pattern Generator
3782A Error Detector

Ordering Information

3781B Pattern Generator
3782B Error Detector

TELECOMMUNICATIONS TEST EQUIPMENT

Dedicated 150 Mb/s PCM/TDM Error Detection System

Models 3762A/3763A, 3764A

3762A/3763A

- Binary bit-by-bit error detection
- Coded and binary operation
- Variable clock frequency offsets

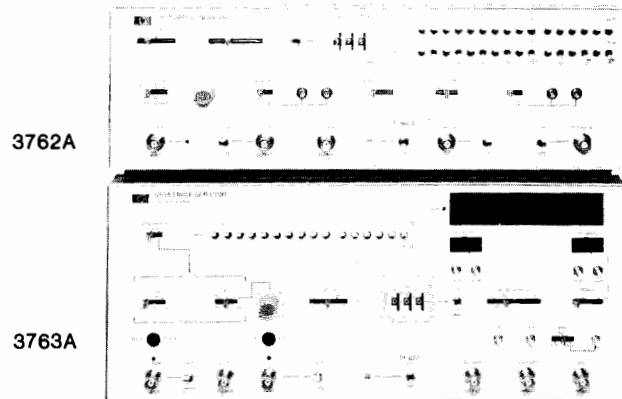

3762A

3763A

3764A

- Full 140 Mb/s error measurement
- Jitter generation and measurement
- Portable single-unit construction

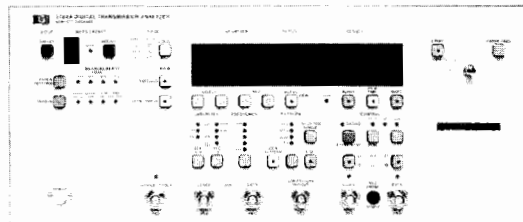

3764A



3762A Data Generator/3763A Error Detector

The 3762A Data Generator and 3763A Error Detector comprise a dedicated error rate measurement system for evaluating high-speed digital transmission equipment. Basically, there are two versions of the system available. One features CMI and binary data formats and is specifically intended for use in field commissioning and maintenance of digital radio (terrestrial microwave and TDMA satellite) systems. The other version, with CMI and ternary (HDB3 and B3ZS) data formats, is designed for digital multiplex and digital cable systems. Burst gating inputs allow the 3762A/3763A to be used in TDMA applications

Specifications Summary

3762A Data Generator

Internal clock: two crystal clocks in the range 30 to 150 MHz; crystals fitted in standard unit are 139.264 and 141.040 MHz; offset continuously variable up to ± 60 ppm.

External clock input: 1 kHz to 150 MHz; 75 ohm.

Patterns: $2^{10}-1$, $2^{15}-1$, and $2^{23}-1$ PRBS; two 10- or 16-bit programmable words: two 1010... repetitive patterns; two 8-bit words alternated by an external signal; PRBS patterns can be gated off for 1 to 999 clock periods after trigger pulse (zero substitution); error add facilities.

3763A Error Detector

Data input: CMI, NRZ, or RZ formats; 75 ohm; DATA or $\overline{\text{DATA}}$; 12 dB fixed equalization at 70 MHz on CMI inputs with clock recovery.

External clock: as 3762A.

Patterns: all the patterns of the 3762A, including zero substitution, but excluding alternating words.

Count: totalizes errors over a selected gating period; internal period can be 10^6 , 10^8 , 10^{10} clock periods or 1 min to 24 h, repetitive or single shot, manual start/stop or external (ECL) control; result displayed as ABCD.

Measurement gating input: gates error and clock inputs to error counter, providing a measurement "window"; 50 ohm; ECL levels.

Frequency offset measurement: measures deviation of received bit rate from nominal rate; result displayed as $\pm \text{BCD} \times 10^{-6}$.

Printer output (rear panel): 8-4-2-1 BCD, 10-column output of result plus local time, if required, and flags; TTL print command pulse.

Recorder output (rear panel): constant current drive output of BER or COUNT result, with flags.

Ordering Information

3762A Data Generator

3763A Error Detector

3764A Digital Transmission Analyzer

The 3764A Digital Transmission Analyzer is Hewlett-Packard's new product for analyzing the error performance of high speed digital transmission systems. Three versions of the 3764A are produced, each being designed to fulfill different operating requirements. This flexible approach allows the 3764A to provide substantial benefits in a wide range of applications, from design and development to commissioning and maintenance.

- Standard 3764A — this is a dedicated 140 Mb/s digital transmission analyzer with pattern generation, error detection and error analysis capabilities. The error analysis provision includes error performance measurements for testing the proposed Integrated Services Digital Networks (ISDN).
- Multiple frequency version — option 001 instruments provide the standard 3764A's measurement capability at the four main CEPT bit-rates of 2, 8, 34 and 140 Mb/s. This reduces the number of test sets required in multiple frequency environments.
- Jitter version — in addition to the standard 3764A's measurement capability option 002 instruments also provide jitter generation and timing jitter measurement at 140 Mb/s. This offers a cost-effective solution to 140 Mb/s testing requirements.

Specifications Summary

Generator Section

Clocks: internal clock 139.264 MHz; offset clocks + and - 15 ppm; external clock 1 kHz to 170 MHz.

Data outputs: CMI format at 139.264 Mb/s; Binary RZ or NRZ from 1 kb/s to 170 Mb/s, ECL levels, 75 ohm unbalanced.

Patterns: PRBS $2^{23}-1$; WORD, 1 to 16-bit fully programmable; ALT WORD, two 1 to 8-bit programmable words, crossover rate controlled by external signal; AIS, "all ones" pattern.

Receiver Section

Recovered clock: 139.264 ± 3 Mb/s.

Binary clock: 1 kHz to 170 MHz.

Data inputs: 75 ohm Terminated mode; Monitor mode; Binary, RZ or NRZ, ECL levels; External Error, ECL levels.

Measurements Performed

Error performance: % Availability, % ER $\leq N$, % EFS.

Errors: Error Ratio, Error Count, Error Seconds, Error Free Seconds.

Options

001: four internal frequencies.

002: jitter generation and measurement.

3764A Digital Transmission Analyzer

TELECOMMUNICATIONS TEST EQUIPMENT

Dedicated PCM/TDM Jitter Generator and Receiver

Models 3785A, 3785B

547



- Jitter generation and measurement on data and clock
- Jitter specifications designed to CCITT recommendation 0.171
- Transient-free sweeping of internal CCITT defined jitter tolerance masks

- Single portable unit for up to 4 internal bit rates
- Built-in measurement filters to CCITT recommendations
- Comprehensive jitter analysis against real-time and jitter amplitude

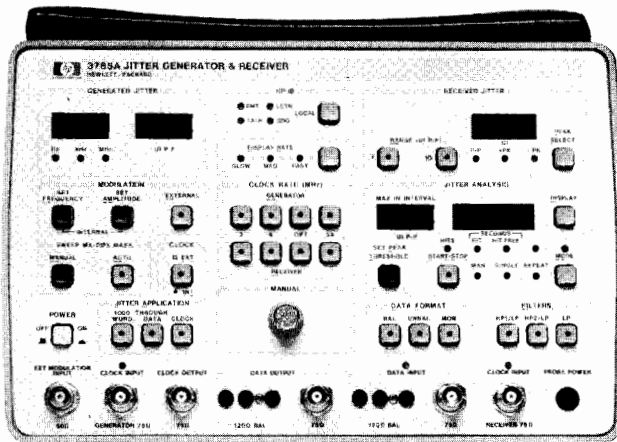

3785A (2048, 8448, 34368 and, optionally, 25776 kHz)
CEPT

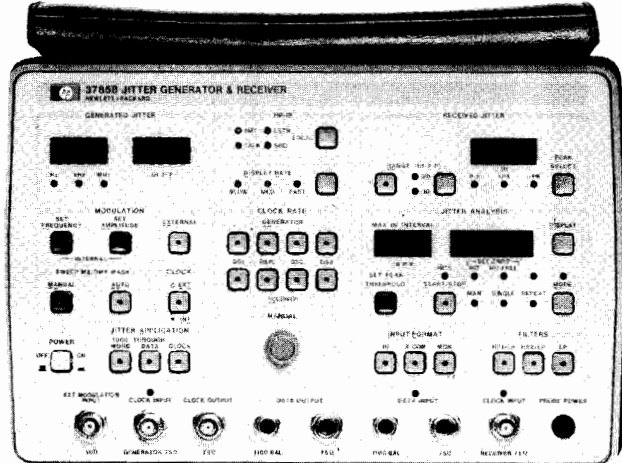

3785B (DS-1, DS-1C, DS-2 and DS-3)
Bell



The 3785A/B Jitter Generator and Receiver is a dedicated jitter measurement system for testing and evaluating the performance of CEPT or Bell digital transmission terminal and link equipment up to and including the third level (34368 kb/s or DS-3) in the digital hierarchy. The 3785A/B can be used in production testing, field installation and maintenance of the CEPT or Bell digital transmission system including PCM/TDM transmission over cable, radio, satellite, and fiber optic links. The principal application is thorough testing to current CCITT Recommendations at each level in the digital hierarchy.

In addition to providing a comprehensive measurement capability which includes in-service jitter measurements, the microprocessor-controlled Jitter Generator and Receiver is easy to use with ergonomic layout of switches and connectors on the front panel. The instrument is designed to interface fully with the HP-IB, allowing bus-controlled operation and automatic measurement sequencing.

The Jitter Generator may be used to phase modulate an internally provided crystal clock, an externally applied clock (at a nominal digital hierarchy bit rate) or an externally applied data stream. Sinusoidal modulation is provided by an internal synthesizer whose amplitude and frequency can be set manually or swept, transient-free, through a CCITT shaped jitter tolerance mask programmed into the instrument. Alternatively, external modulating signals can be applied. The amplitude of generated jitter in unit intervals (U.I.) pk-pk and the frequency of internal modulation are in accordance with CCITT Recommendation 0.171 and are displayed on the front panel.

The modulated clock output can be applied to an external pattern generator such as the 3780A, 3762A, 3781A or 3782B. For jitter transfer function measurements, the CCITT standard 1000 repetitive pattern is provided within the 3785A/B. In addition, for demultiplexer jitter transfer function, jitter can be applied to an externally applied data stream which has the necessary framing and justification digits. Consult the data sheet for full technical specifications.

Consult the data sheet for full technical specifications.

Measurements

The Jitter Receiver offers six types of measurement:

- Absolute jitter amplitude in U.I. pk-pk
- Jitter peak, positive or negative
- Jitter hit count of the number of times received jitter exceeds a user-defined hit threshold in U.I. pk

- Jitter hit seconds count of the number of seconds in which one or more jitter hits occur
- Jitter hit-free seconds count of the number of seconds which are free of jitter hits
- Maximum absolute jitter amplitude in U.I. pk-pk is held during the jitter analysis gating period

Simultaneous measurement of all six parameters is possible with result display selection. In addition, the Receiver has a built-in interval timer and real-time clock to allow measurements of jitter distribution against time to be made.

The measurements can be made on clock or data inputs with or without internal filtering. Two high pass filters and one low pass filter as specified by CCITT are provided for each of the four bit rates. In addition, external filters can be connected between the demodulated jitter output and the measuring circuitry input. The demodulated jitter output can also be used to measure rms jitter amplitude on an external voltmeter or to display jitter spectrum on an external analyzer.

The clock reference for the jitter measurements can be internally derived from the applied data or clock via a narrow band phase-locked loop or externally derived from an applied reference.

The data input allows out-of-service or in-service measurements. The MON facility for in-service measurements has built-in additional gain to compensate for the flat loss at the protected monitor points.

HP-IB Operation

The capabilities of the 3785A/B can be enhanced by using the HP-IB to provide remote operation and automatic sequencing of results.

The HP-IB facility offers several principal features:

- Remote control of front panel switches and pushbuttons using programming codes
- Control codes which are set to default values on power-on and can be user-defined with the controller
- The ability to transfer all desired switch positions and masks onto a tape memory and reloaded back onto the instrument at a later time
- Output of the result data to a printer (eg 5150A Thermal Printer) or storage memory

Ordering Information

3785A Jitter Generator and Receiver (CEPT)

3785B Jitter Generator and Receiver (Bell)

TELECOMMUNICATIONS TEST EQUIPMENT

PCM/TDM Accessories

Models 15506A, 15507A, 15508B, 15508C, 15509A, 15509B, 15510A, 15511A, 15512A, 15513A, 15514A, 15515B



15506A



15509A

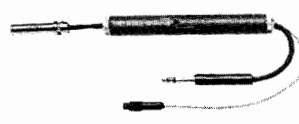

15509B

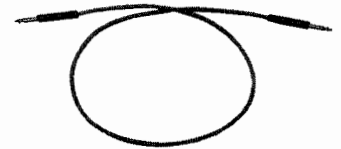

15513A

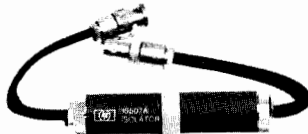

15507A



15510A

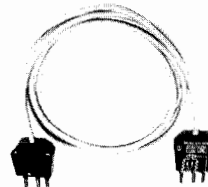

15511A

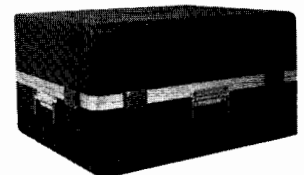

15514A



15508B

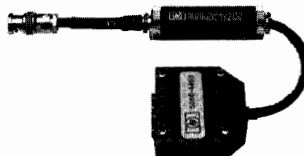

15508C

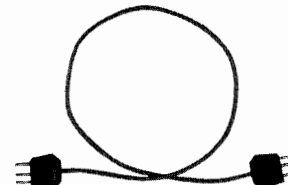

15512A

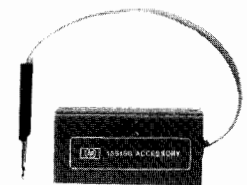

15515B

15506A Frame Alignment Generator

The 15506A provides a 2048 kb/s PCM signal, complete with framing structure, coded in AMI or HDB3 via a 75 Ω unbal or 120 Ω bal output. It can be used for checking the operation of the 3783A 30 Ch PCM Alignment Monitor and Error Detector.

15507A Isolator

This unit provides isolation from longitudinal voltages which may appear on test connections to digital transmission equipment. It can also be used when the ground potential of the test equipment is different from that of the transmission equipment.

15508B Converter (75 Ω unbal—110 Ω bal)

This unit provides a nominal 110 Ω balanced interface conversion from 75 Ω unbalanced interfaces on digital test equipment. This is required at the 1544 kb/s DS-1, 3152 kb/s DS-1C, and 6312 kb/s DS-2 levels of North American digital transmission systems.

15508C Converter (75 Ω unbal—120 Ω bal)

The 15508C provides a nominal 120 Ω balanced interface conversion from 75 Ω unbalanced interfaces on digital test equipment. This may be required at the 2048 kb/s primary multiplex levels of European digital transmission systems.

15509A Amplifier

This unit is designed to provide sufficient gain on a digital signal appearing at a standard digital equipment protected monitor point to trigger the Error Detector input. This is required to monitor in-service systems for code violations. Power for the 15509A is supplied from the error detector front panel PROBE POWER socket.

15509B Amplifier

The 15509B is similar to the 15509A except that it is intended for operation at the DSX-1, DSX-1C, and DSX-2 monitor points of North American digital transmission systems.

15510A 75 Ω Cable Accessory

The 15510A is designed to provide a protected monitor point to the 15509A input. This allows the Error Detector to monitor in-service

systems (75 Ω) for code violations when the system monitor point is unprotected.

15511A 120 Ω Cable Accessory

The 15511A is designed to provide a protected monitor point to the 15508C input and, subsequently, the 15509A input. This allows the Error Detector to monitor in-service systems (120 Ω) for code violations when the system monitor point is unprotected.

15512A Cable

The 15512A is a 1 m length of 600 Ω balanced cable with a 3-pin audio connector (Siemens type) at each end.

15513A Cable

The 15513A is a 1 m length of 600 Ω balanced cable with a WECO 310 jack plug at each end.

15514A Transit Case

The 15514A is a transit case with moulded foam inserts for transporting the 3779 Primary Multiplex Analyzer.

15515B Loop Holding Unit

Model 15515B is a loop holding unit which provides 24 mA loop holding current sinking. It is supplied with WECO connectors.

Ordering Information

15506A Frame Alignment Generator

15507A Isolator

15508B Converter (75 Ω unbal—110 Ω bal)

15508C Converter (75 Ω unbal—120 Ω bal)

15509A Amplifier

15509B Amplifier

15510A 75 Ω Cable Accessory

15511A 120 Ω Cable Accessory

15512A Cable

15513A Cable

15514A Transit Case

15515B Loop Holding Unit

TELECOMMUNICATIONS TEST EQUIPMENT

Cable Maintenance and Construction (CMC)

4960, 4961, 4910G, 4930A, 4904A, 4905A, 4918A



	Buried Plant									Aerial or Underground Plant						
	Path/Depth	Shield or Conductor to Earth	Short	Cross	Ground	Split	Open	Pair I.D.	Short	Cross	Ground	Split	Open	Pair I.D.	Gas Leak	
ULTRASONIC DETECTORS																
4905A																
4918A																
DIRECT READING FAULT LOCATORS																
4910G																
4930A			H	H	H				H	H	H					
SHEATH FAULT AND CABLE LOCATORS																
4904A																
PAIR IDENTIFIERS																
4960B																
4961B																

H = Maximum Sensitivity to high resistance faults

CMC Test Sets

For cable maintenance and construction (CMC), Hewlett Packard offers test sets that will locate most any fault that is likely to occur in a cable. In addition, advanced pair identifier systems provide simplified and fast identification of wire pairs. Mostly employed by telephone operating companies, this test equipment is also used by power companies, cable TV service, city governments and electrical contractors.

The easy reference matrix above shows the areas in which these test sets are used most effectively. It cross-references the test sets to specific tasks in aerial, buried and underground cables.

4960/4961 Automatic Pair Identifier System

The Automatic Pair Identifier system simplifies and makes reliable the identification and testing of working and non-working telephone cable pairs in loaded or non-loaded telephone cables up to 40,000 feet in length. The system has two parts, the 4960 office unit and the 4961 field unit. The office unit operates unattended and is connected to the Main Distribution Frame (MDF) or the access point. A push button starts the operation of testing, identifying and determining the status of each pair. A hundred pairs can be identified in minutes without a control pair.

There are four operating modes: self-check, shoe check, scan mode and select mode. Self-check tests the operation of the system. Shoe check determines if proper contact is made to the MDF. Scan mode determines the pair number of a randomly chosen pair. Select mode instructs the office unit to send a tone to enable the field unit to trace a pair.

4910G Open and Split Fault Locator

The 4910G is designed to provide direct distance readings to opens and splits at the push of a button. It works in the presence of cross battery voltages and leakage resistance. It can be used with or without a good reference pair. The 4910G operates on a capacitance charge sampling principle which relates the change placed on a length of wire to its capacitance and hence its length. The test set averages out the effect of noise on the line by automatically taking several readings on the pair. The distance to a fault or split is displayed on an autoranging display.

4930A Conductor Fault Locator

The 4930A is an automatic, digital, direct reading test set operating on the Wheatstone Bridge principle. It is designed to locate extremely high resistance shorts, crosses and grounds. This completely portable, battery operated fault locator is housed in a ruggedized weatherproof case. Faults are easily located in buried, underground or aerial cable and wire. The 4930A is connected to the cable pairs at the access point and the far end of the cable is strapped to form a bridge configuration. Measurements can then be made on either the distance to

the fault, distance strap to fault or distance to the far end. The 4930A contains push button checks of the fault resistance, the condition of the strap, as well as of its 12V battery.

4904A Cable Fault Locator

The 4904A is a pulsed-tone system that accurately locates path and depth of buried cables and pipes. It can also be used for locating shorts, crosses and grounds in aerial, underground (ducted), and direct buried cable. This is a complete, self-contained, troubleshooting system designed for one person operation. Readings are visual, on a meter, and audio on a built-in speaker or headset. It comes complete with transmitter, receiver, search wand, earth contact frame, cables and ground rod.

4905A and 4918A Ultrasonic Leak Detectors

The 4905A is a lightweight, portable ultrasonic detector which includes an 18020A directional probe. It is used to detect leaks in aerial cables by detecting the ultrasonic noise created by the leak and converting this to the audible range. By observing the level meter, the craftsman can "peak-in" on the the leak and determine its exact location.

The 4918A Ultrasonic Leak Detector combines near-laboratory performance with field portability. It is a complete system listed by Underwriters' Laboratories, Inc., for use in Class 1, Group D hazardous environments.

There are many applications for ultrasonic detectors other than detecting pressurized gas leaks. Using air as the conducting medium, corona discharge and arcing from electrical equipment can be detected. In piped systems the operation of steam traps, heat exchangers, and valves can be checked.

Ordering Information

- 4904A Cable Fault Locator
- 4905A Ultrasonic Leak Detector
- 4910G Open & Split Fault Locator
- 4918A Ultrasonic Leak Detector
- 4930A Conductor Fault Locator
- 4960B Automatic Pair Identifier (Office Unit)
- 4961B Automatic Pair Identifier (Field Unit)

Accessories

- 18021A Contact Probe (for Ultrasonic Detectors)
- 18043A Ultrasonic Reflector

TELECOMMUNICATIONS TEST EQUIPMENT

General Information: Radio and FDM Carrier System Testing

Frequency Division Multiplex (FDM) systems are the traditional method of transmitting a number of telecommunications channels over a single wideband transmission medium such as coaxial cable or microwave radio, each channel being allocated a unique part of the frequency spectrum. In narrow satellite or radio channels there might be only 12 or 24 telephone channels, whereas in a high capacity 12 MHz or 18 MHz system 2700 or 3600 channels can be transmitted simultaneously.

Despite the move to digital transmission, resulting from the low-cost and efficiency of digital message switching, analog systems still provide the most economical form of long-haul transmission particularly in the flexibility provided by the latest developments in low-capacity and high-capacity FM radios and by the new Single Sideband Radio designs which can transmit over 5000 channels per 30 MHz microwave band. These advances together with the very large installed base of FDM systems require similar advances on measuring transmission performance to meet modern network objectives.

Helwett-Packard supplies a comprehensive range of manual and automatic test-equipment, summarized in the table below, for FDM baseband, microwave radio and satellite systems.

FDM Measurements

The 3586A/B Selective Level Meter (SLM) and its companion Synthesizer/Level Generator the 3336A/B are specifically designed for manual measurements in manufacture, installation and maintenance. Both instruments incorporate synthesizer tuning for stability and resolution and provide absolute level accuracy of ± 0.2 dB (SLM) and ± 0.15 dB (Generator). The 3586A/3336A combination is optimized for testing to CCITT standards and the 3586B/3336B to Bell or North American standards.

Both 3586A/B and 3336A/B are HP-IB programmable and can be combined into a low-cost system with the HP85F Personal Computer. This system, the 3046A/B, is simple to use and enables automatic multiple measurements and sequences to be set up using the stored FDM plans. Up to four test points can be accessed by means of a 3755A Access Switch Controller and 3754A Access Switch.

The 3746A SLMS, developed from the 3586A/B, has been optimized for FDM maintenance measurements particularly in automatic network monitoring systems. Its built-in "intelligence" enables high speed scans of FDM signals using the internally stored FDM plans and limits which check for unacceptable levels. Group power measurements and hot-tone search provide rapid detection of high level signals (see Application Note AN 323). The 3746A has a built in access switch controller (similar to the facilities of the 3755A Access Switch Controller) to provide low-cost system integration with the 3754A, 3756A and 3757A Access Switches. The internal real-time clock allows limit violations to be logged on an external printer

with the time of occurrence. All these facilities are available from the keyboard or programmable from a system controller.

The performance objectives for present day networks, and customer expectations, particularly business customers and data users, demand rapid fault location and analysis of system degradation. Hewlett-Packard offers two automatic monitoring systems designed round the 3746A SLMS: the 37050S system based on the HP 1000 A-Series Computer, and the 37051S based on the 9816S Personal Technical Computer. The 37051S is a low-cost measurement system for smaller networks providing control of up to six remote measurement subsystems each with up to 45 access points. The software on the 9816S stores data-base information on the test points and allows a surveillance routine to be run continuously using sequence files. These can be interrupted at any time for demand measurements.

The computer based 37050S system has all of these features and in addition can control up to 16 remote subsystems per computer and provides comprehensive data reduction and results reporting — for the larger system this is essential. The computer utilizes powerful Real-Time Executive (RTE) Operating System Software, so (unlike the 37051S) can provide simultaneous measurements at multiple sites and can support several users at local or remote terminals. The 37050S can be readily extended to cover a very large network by linking computers using DS/1000-IV Network Software.

Microwave Radio Measurements

Radio measurements divide into two categories, qualitative baseband measurements and analytical IF and RF transmission measurements. Baseband measurements traditionally require several separate pieces of test equipment, e.g., white-noise test set, SLMS and generator, wideband power meter and spectrum analyzer. The 3724A/25A/26A Baseband Analyzer includes all these measurements in one convenient, high-

performance package which is not only easy to use but also avoids the need to recable and retune separate instruments.

The full power of the Baseband Analyzer is realized when it is operated with the two Hewlett-Packard software packages for automated baseband measurements: the 37018A for local measurement using the HP 85F Personal Computer, and the 37018B for end-to-end measurements using the HP 87XM Personal Computer. Sequences of measurements can be programmed and a complete documented record of radio performance including white-noise loading curves can be obtained in 10 to 15 minutes. Further analysis of the radio is possible using the V-curve analysis application software (see Application Note AN320) significantly reducing down-time.

White-noise testing can also be carried out at IF interfaces using the 3717A 70 MHz Modulator/Demodulator. This is a compact, high performance unit incorporating selected pre- and de-emphasis networks to CCIR and Bell standards.

The complementary set of IF transmission measurements, including group delay, amplitude flatness, differential gain and linearity, are used mainly for troubleshooting. The Hewlett-Packard Microwave Link Analyzers (MLAs) are equipped to make the full range of these measurements at 70 MHz (3710A, 3702B) and 70/140 MHz IF (3711A, 3712A). They are well established products with a very good reputation for reliability and accuracy essential for examining individual sections of the radio. Interpretation of MLA measurements and the relationship to white-noise testing is covered in Hewlett-Packard Application Note AN175-1 "Differential Phase and Gain at Work".

These MLA transmission measurements can be readily extended to RF interfaces using the high-performance 3730B Down Converter, and the 8620C Up Converter Simulator. In both these instruments the different microwave bands are covered by a range of plug-ins.

		MAINTENANCE/ MONITORING	INSTALLATION	MANUFACTURE
FDM Measurements	Manual	3586A/B, 3746A	3586A/B, 3336A/B	3586A/B, 3336A/B
	Automatic	3046A/B, 3746A	3046A/B, 3746A, 3336A/B	3046A/B
	Surveillance	37050S, 37051S	—	—
Radio Baseband Measurements	Manual	3724A/25A/26A, 3717A		
	Automatic	37018A/B, 37050S, 37051S 3717A	37018B, 3717A	37018A, 3717A
IF Transmission Measurements		3710A/3702B 3711A/3712A		
RF Transmission Measurements		3730B 8620C, 8350B		

TELECOMMUNICATIONS TEST EQUIPMENT

Selective Level Measuring Set, HP-IB CRT Display

Models 3746A, 37461A

551



- Fast, accurate measurements on frequency division multiplex (FDM) systems
- Selective filters for pilot, channel and (optionally) group power and weighted noise measurements
- Automatic tuning to stored frequency plans with comparison of measured level to stored limits
- Built-in access switch controller, real-time clock and frequency counter
- HP-IB controller for external printer, frequency synthesizer and companion display unit
- Versatile, efficient remote system device in computer-controlled HP-IB systems



3746A

37461A

3746A Selective Level Measuring Set (50 Hz to 32 MHz)

The 3746A Selective Level Measuring Set (SLMS) is designed to make fast, accurate selective level measurements. A built-in frequency synthesizer gives accurate, stable tuning to the precise frequency at which the measurement is to be made. The 3746A can be tuned over its frequency range (50 Hz to 32 MHz) with a resolution of 1 Hz.

The SLMS measures true rms power between +20 dBm and -120 dBm with 1 dB, 0.1 dB, or 0.01 dB resolution. Fully auto-ranging attenuators and amplifiers simplify operation further by eliminating the need to set attenuators and add meter readings. Measurement results are automatically displayed to the selected resolution, in dBm or dB relative terms, on an LED display. The absolute accuracy of the measurement over wide level and temperature ranges is $< \pm 0.25$ dB.

Many benefits are derived from the purpose designed filters contained in the SLMS. The 38 Hz pilot filter has a flat top over 22 Hz, necessary for automatic tuning, and achieves high out-of-band rejection so that, for example, carrier leak can be measured on active systems. The channel filter is a flat-topped 3.1 kHz filter which can be used for measuring all signals in the voice channel and provides high out-of-band rejection. Optional weighted filters are available to make either true 'C'-message or CCITT psophometrically weighted noise measurements. These options also provide the following voice channel impairment measurements: single level impulse noise, phase jitter and noise-with-tone measurement. A 48 kHz filter for group power measurements is available by option to facilitate fast location of high level signals on a multiplex.

The 3746A is internally controlled by a microprocessor which provides many ease-of-use and time-saving features. As well as tuning exactly to an entered frequency, the SLMS can refer to CCITT or Bell multiplex frequency plans in its memory and automatically tune to the correct frequency at any level in the multiplex. Other frequency plans, as used for example on submarine cable or satellite links, can be installed to special order. Also, up to 145 unrelated frequencies can be stored in non-volatile memory and the SLMS programmed to scan through these frequencies. The comprehensive FDM plan and frequency storage capability of the SLMS eliminates the need for the operator to refer to FDM plan charts and tables. The SLMS can automatically step through pilots and supervisory tones, channels, group powers, carrier leaks, etc, across the baseband of a multiplex—comparing levels with pre-determined alarm limits and providing a print-out of limit violations on a separate printer. 250 pilot measurements can be made in about 2 minutes and 2700 channel powers can be measured in about 5 minutes.

Control of test point selection is provided by means of a built-in Access Switch Controller. This performs a function similar to the 3755A Switch Controller: control of 3754A, 3756A, or 3757A Switches to select 1 from a possible 1000 RF outputs. A 3-digit display on the SLMS front panel indicates the selected port. Another useful feature is the SLMS's integral Real-time Clock which can display time or date and holds the correct time even when the SLMS is switched off. If a printer is connected to the 3746A via the HP-IB, the SLMS can be configured to output measurement results to the printer together with the date and time at which each measurement is made.

The 3746A is fully programmable via the HP-IB, and can itself assume the role of system controller. In this mode, selectable by a rear panel switch, the SLMS can control a tracking Frequency Synthesizer (models 3330B, 3335A, 3336A/B are compatible), a 20- or 80-column Printer (for example, 5150A or 2631B), and a 37461A CRT Display. It is thus possible to assemble a self-contained test station for network maintenance and surveillance.

3746A Options

- 001: Siemens series 1.6/5.6 mm 75 Ω connectors
- 005: WECO 477B/223A (equivalent) connectors
- 011: 48 kHz group filter
- 012: tracking generator
- 014: high stability frequency reference
- 015: channel impairments—CCITT
- 016: channel impairments—North America
- 907: front handle kit
- 908: rack flange kit
- 909: rack and handle kit
- 910: extra set of manuals

3746A Selective Level Measuring Set

37461A Display

The 37461A Display is a CRT-based display unit with integral processor and HP-IB interface. Under control of the 3746A SLMS, a graticule with labelled frequency and level axes is displayed and up to 256 measurement results can be plotted. This type of visual presentation enables speedy assessment of overall traffic loading, identification of spurious signals and detection of high level users.

37461A Options

- 907: front handle kit
 - 908: rack flange kit
 - 910: extra set of manuals
- #### 37461A Display



TELECOMMUNICATIONS TEST EQUIPMENT

Access/Distribution Switches and Controller, SLMS Accessories

Models 3754A, 3755A, 3756A, 3757A, 15580A, 15581B, 15582A, 15589A

- Select 1 from a possible 10 RF inputs/outputs
- Cascade up to 111 Switches to allow selection from 1000 inputs/outputs
- Mix different Switches for the most cost-effective solution
- Switches controllable from 3755A Switch Controller or 3746A SLMS
- Remote input selection using HP-IB (3755A or 3746A)
- 75 Ω termination of unselected ports



3754A



3756A

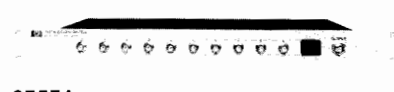

3757A

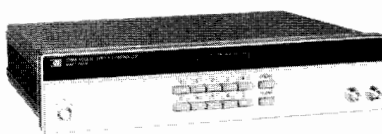

3755A

The 3754A, 3756A and 3757A Switches and the 3755A Controller have been developed to meet the requirements of four main areas.

1. Frequency Division Multiplex (FDM) system surveillance and maintenance—the Switch arrangement is used in conjunction with a Selective Level Measuring Set (SLMS), such as the 3746A, to monitor pilot and traffic levels at various points in the multiplex. The 3746A SLMS can control the Access Switches directly without needing the 3755A Controller.
2. Production testing—where automatic selection or distribution of RF signals is required.
3. IF access and distribution—70 MHz IF signals can be switched using the 3756A for connection to the 3717A 70 MHz Modulator/Demodulator.
4. Access and distribution of digital communications signals up to 34 Mb/s (CEPT) or 44.7 Mb/s (DS-3).

3754A 25 MHz Access Switch

The 3754A 25 MHz Access Switch is an ac-coupled, uni-directional, ten-input switch with a frequency range from 10 kHz to 25 MHz. The 3754A incorporates a virtual-ground amplifier—giving an insertion loss of $< \pm 0.1$ dB from 50 kHz to 20 MHz and high isolation across the whole frequency range. The isolation between any unselected input and the output is > 85 dB and the isolation between any two inputs is > 90 dB. In addition, pre-set gains of 1, 2 and 3 dB are internally selectable to compensate for losses in cables and equalizers.

3756A 90 MHz Bi-directional Switch

The 3756A 90 MHz Switch is a dc-coupled, bi-directional, ten-way switch with a frequency range from dc to 90 MHz. The 3756A offers isolation of > 80 dB between channels, and > 75 dB between unselected input and output ports. It has an insertion loss of 1 dB with a flatness of ± 0.2 dB and > 28 dB return loss.

3757A 8.5 MHz Access Switch

The 3757A 8.5 MHz Access Switch is a low-cost, ac-coupled, uni-directional, ten-input switch with a frequency range of 10 kHz to 8.5 MHz. An option provides expanded frequency range from 200 Hz to 8.5 MHz. The 3757A has an insertion loss < 0.1 dB from 10 kHz to 4 MHz and isolation of > 95 dB between channels. In addition, pre-set gains of 1, 2 and 3 dB are internally selectable to compensate for losses in cables and equalizers. (The 3757A is powered from a ± 15 V dc supply.)

3755A Switch Controller

The 3755A Switch Controller has a small, easy-to-operate keyboard with a 3-digit LED display to denote the input or output select-

ed. Each Switch (3754A, 3756A or 3757A) is given a 1-digit code, to select the required port from up to 1,000.

The 3755A Switch Controller can be remotely controlled over the Hewlett-Packard Interface Bus (HP-IB) by a desk-top computer. If the 3746A is used as Switch controller, similar principles apply.

Active and Passive Probes

Models 15580A and 15581B High-Impedance Probes are used with the SLMS for bridging measurements. The 15580A is an "active" device powered from the SLMS having an insertion loss of 0 dB. Model 15581B is a passive probe having an insertion loss of 20 dB. The 15581B can also inject signals from a Level Generator at points where a high impedance source is required.

Specifications

Parameter	15580A	15581B
Frequency Range	20 kHz to 25 MHz	10 kHz to 25 MHz
Insertion Loss	0 dB \pm 0.2 dB (50 kHz to 20 MHz)	20 dB \pm 0.2 dB (50 kHz to 20 MHz)
Tapping Loss (in 75 Ω system)	< 0.15 dB (50 kHz to 20 MHz)	< 0.25 dB (50 kHz to 20 MHz)

Return Loss Kit

Model 15582A Return Loss Kit, with a suitable Level Generator, allows the SLMS to make return loss measurements from 10 kHz to 25 MHz.

Instrument Cart

Model 15589A is suitable for transporting the SLMS and its auxiliary equipment.

Ordering Information

- 3754A 25 MHz Access Switch
- 3755A Switch Controller
- 3756A 90 MHz Bi-directional Switch
- 3757A 8.5 MHz Access Switch
- 15580A Active Probe
- 15581B Passive Probe
- 15582A Return Loss Kit
- 15589A Instrument Cart

TELECOMMUNICATIONS TEST EQUIPMENT

FDM Network Monitoring Systems

Models 37050S, 37051S

553



- Automated FDM network monitoring
- Multiple remote SLMS control
- Integral CCITT and Bell FDM plans

- Flexible configurations
- Fast, accurate measurements
- Concise result presentation

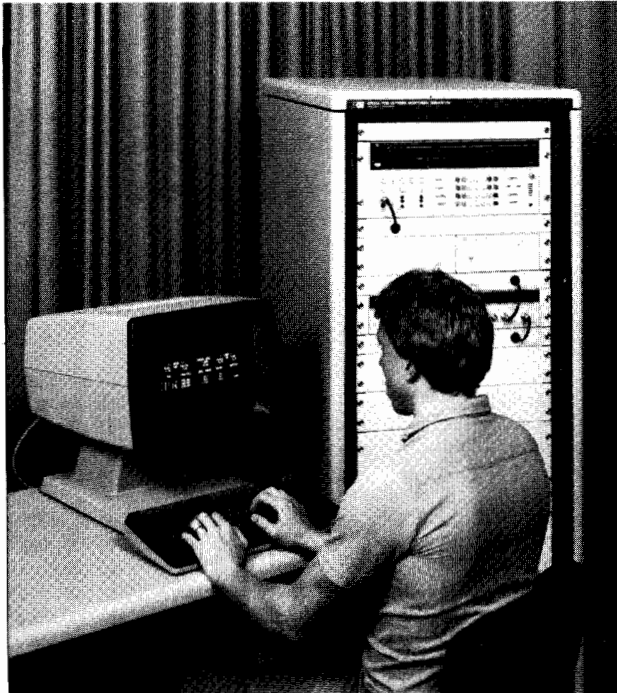

37050S

The 37050S and 37051S provide the ability to monitor continually both Bell and CCITT Frequency Division Multiplex (FDM) networks.

These Systems allow faults or deteriorations within an FDM network to be isolated and rectified in the shortest possible time. The 37050S has been designed to meet the demands of large, high capacity FDM networks, whilst the 37051S provides a low-cost solution for small FDM networks.

System Structure

Both Systems use the extensive measurement capability and built-in intelligence (including FDM plans) of the 3746A Selective Level Measuring Set (SLMS). Expandable access switching arrangements using 3754A (25 MHz) or 3757A (8.5 MHz) switches enable each SLMS to monitor at a number of test points.

Both Systems employ specialized software packages to control their operation, and provide data base information, measurement routines and dedicated control software (e.g. time-scheduling routines).

Data Base Assistance

The 37050S and 37051S both incorporate a system data base to simplify system operation. Information detailing the required measurements and the test points at which they should be performed (e.g. test level, gain parameters) need only be entered once initially. This information is available to both the computer or manually initiated automatic measurements.

Comprehensive Measurements

Measurements supported by the Systems include:

- Pilots
- Carrier Leaks
- Noise (Intersubgroup Slot, Channel)
- Power (Broadband, Channel, Group, Supergroup)
- Tones (Test, Signaling)
- Fast High Level Searches (FDM, Spectrum)
- Channel Impairments (Phase Jitter, Impulse Noise, Noise with Tone) — 37050S only

37050S FDM Network Monitoring System

The 37050S is a flexible automatic measurement system for use in the commissioning, monitoring, fault-finding and maintenance of FDM transmission networks.

The System operates under the direct control of an HP1000 A-Series Computer System which gathers measurement data concurrently from remote SLMS-based instrument Subsystems. Up to 16 remote Subsystems can be continuously monitoring network performance. Specialized result modes are provided which reduce the mass of data available to only that which is really relevant.

A number of User Terminals (VDU/keyboard) can be added to the 37050S to provide direct on-demand control of all measurements (e.g. for on-the-spot investigations of problems highlighted during automatic monitoring).

HP's Distributed Systems Network Software, DS/1000-IV, can be incorporated to allow two or more Computer Systems to be linked together. This facility enables a 37050S System to be expanded beyond 16 SLMSs.

37016A FDM Network Monitoring Software

The 37016A Software is the power behind the 37050S and is used to control all the operations of the FDM Network Monitoring System. The Software includes measurement programs and also functional tests for verifying that the instruments at the remote sites function correctly.

37051S FDM Measurement System

The 37051S is the ideal answer for the operator of a small FDM network who wishes to make measurements quickly at several remote, possibly unmanned, FDM installations and present the information obtained at one central location.

This System operates under the control of a 9816S Personal Technical Computer which provides sequential control of up to 6 remote SLMSs. Surveillance sequences can be created in which all the SLMSs are controlled in succession. User initiated measurements, temporarily interrupting any surveillance sequence, can be made to investigate a problem highlighted by surveillance.

37051S operators retain the ability to later expand their monitoring system to the 37050S as their networks grow or needs change.

37014B FDM Measurement Software

The 37014B Software controls the 37051S System providing measurement programs and also functional tests for verifying that the instruments at the remote sites function correctly.

Table 1. Monitoring Systems Summary

	37050S	37051S
Automated measurements (continuous and time-scheduled)	YES	YES
Measurements on-demand	YES	YES
Result storage capability	YES	YES
Maximum number of supported SLMSs per controller	16 (simultaneously)	6 (sequentially)
Maximum number of test points per SLMS	999	45
User Terminals	YES	NO

Support Services

Full training programs for the 37050S and 37051S are available. All the individual components that make up these Systems (excluding data links) are designed and manufactured by Hewlett-Packard and are backed up by HP's worldwide support.



TELECOMMUNICATIONS TEST EQUIPMENT

Selective Level Meter and Synthesizer

Models 3586A/B & 3336A/B

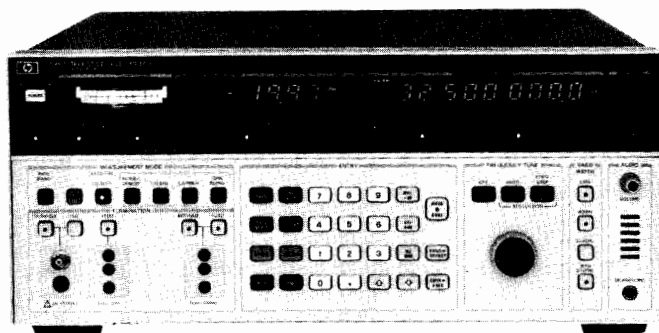

A Selective Level Meter (CCITT) (Shown with Opt 003)



Description

General

Hewlett-Packard's 3586A/B Selective Level Meters and 3336A/B Tracking Synthesizers offer the high performance necessary to meet the demanding requirements in the design, manufacture, commissioning and maintenance of Frequency Division Multiplex (FDM) systems. The 3586 and 3336 "A" models meet CCITT requirements, and the "B" models meet North American (Bell) standards. Both are fully programmable over the HP Interface Bus. The 3586A & B Selective Level Meter provides a unique combination of features, including wideband power and optional telephone impairment measurement of impulse noise, phase jitter, noise with tone, and signal-to-noise with tone ratio. The 3586A & B's wide frequency coverage to 32.5 MHz allows measurements to be made at both voice channel and carrier frequencies. Microprocessor control adds many ease-of-use features such as amplitude offset measurements of tone and noise level in units of dBmO, dBmCO, or dBpWO. Convenience features include simultaneous analog and digital level displays, precise frequency setting with HP's fractional N synthesized local oscillator, accurate frequency counter and tone measurements with automatic channel alignment for 800 Hz (CCITT) or 1004 Hz (Bell) test tone or carrier frequency reference.

The 3336 A/B Synthesizer/Level Generator is an excellent precision tracking signal source for the 3586A and B Selective Level Meter. When the Selective Level Meter and Synthesizer are in the tracking mode, the frequency of the synthesizer is automatically set to the frequency of the SLM. Frequency coverage is 10 Hz to 20.9 MHz, making the 3336 A and B useful for telephone circuit loop testing on most FDM systems, transfer function and distortion measurements in telecommunications manufacturing.

Carrier Frequency and Voice Channel

The 3586A & B can make both carrier frequency measurements to 32.5 MHz and voice channel measurements from 50 Hz to 100 kHz.

You can measure tone levels, idle channel noise or weighted noise at voice channel, then compare at carrier frequency.

Transmission Impairments (optional)

The Transmission Impairments Option 003 permits phase jitter, weighted noise, noise-with-tone, signal-to-noise-with-tone ratio, and single level impulse noise measurements. The 3586A's capability to make these transmission impairment measurements at both FDM voice channel and carrier frequencies is unique.

Frequency and Amplitude Precision

The 3336 A/B provides frequency resolution of one microhertz (.000001 Hz) up to 100 kHz and one millihertz (.001 Hz) to 20.9 MHz. Level accuracy is ± 1.5 dB at full output over the full frequency range with ± 1.2 dB optional. Harmonic levels are more than 60 dB down up to 1 MHz and more than 50 dB down up to 20.9 MHz, performance not previously available in a synthesizer.

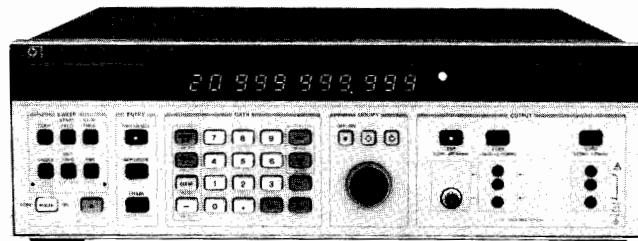

3336A Synthesizer/Level Generator (CCITT)

FDM Testing

The flexible output section allows different connectors to be provided either by option or special request. Frequency entry is accomplished by keyboard or analog control for manual tuning or frequency stepping of any digit.

The Amplitude Blanking feature allows testing of operational FDM systems without disturbing adjacent channels while the frequency is changed. The output is blanked to less than -85 dBm until the next desired frequency is reached.

General Purpose Features

The 3336 A/B Synthesizer provides wide band sweep capability—sweep the full frequency range (or as little as two microhertz), log or linear, single or continuous. Single phase lock loop design means the sweep is phase continuous and you can modulate with AM to 50 kHz or PM to 5 kHz. Ten storage registers can be used to keep different test settings available for repetitive test. All necessary functions on the 3336 A/B can be remotely programmed by HP-IB control for automatic testing.

Designed-In Serviceability

The 3586 A/B Selective Level Meter and the 3336 A/B Synthesizer/Level Generator have been designed for reliable operation and excellent accessibility with many useful service features.

North American (Bell) and CCITT Requirements

The 3586A & B Selective Level Meter and 3336 A & B Synthesizer/Level Generator are designed to meet most world-wide connector and impedance requirements for both carrier and voice channel measurements. Special or regional connectors can be provided by option or special request.

Input Configuration CCITT Requirements

3586A SLM	75 Ω /10 k Ω Unbalanced 150 Ω , 600 Ω /10 k Ω Balanced
3336A Synthesizer	75 Ω Unbalanced 150 Ω , 600 Ω Balanced

North American (Bell) Requirements

3586B SLM	75 Ω /10 k Ω Unbalanced 124 Ω , 135 Ω , 600 Ω /10 k Ω Balanced
3336B Synthesizer	75 Ω Unbalanced 124 Ω , 135 Ω , 600 Ω Balanced

Fully Programmable

HP-IB control is standard, allowing automatic operation to be controlled by a desktop calculator such as the HP Model 85A, 9825T, 9826A, 9835A, 9836A or 9845B, or by a main frame computer, such as the HP 1000. FDM tests such as surveillance can be made from a remote location to reduce maintenance costs and increase troubleshooting efficiency. See page 567 for information on 3046 A/B selective level measuring system.

High Impedance Accessory Probes

Models 15580A and 15581B unbalanced high impedance probes and model 15576A balanced high impedance probe are available for use with the 3586A/B to facilitate bridging measurements.



Frequency

Signal Input	3586A	3586B
75 Ω Unbalanced	50 Hz to 32.5 MHz	
124 Ω Balanced		4 kHz to 10 MHz
135 Ω Balanced		4 kHz to 1 MHz
150 Ω Balanced	4 kHz to 1 MHz	
600 Ω Balanced	50 Hz to 108 kHz	

The 124 Ω, 135 Ω, 150 Ω and 600 Ω inputs are usable over wider frequency ranges, but are not specified in under and overrange operation.

Frequency resolution: 0.1 Hz.

Center frequency accuracy: $\pm 1 \times 10^{-5}$ /year, ($\pm 2 \times 10^{-7}$ /year with option 004).

Counter accuracy: ± 1.0 Hz in addition to center frequency accuracy for signals within the 60 dB bandwidth of the IF filter chosen or greater than -100 dBm (largest signal measured).

Frequency display: 9 digit LED.

Selectivity

3 dB Bandwidth, $\pm 10\%$

3586 (CCITT)		3586B (N. American)	
Standard	Option 003	Standard	Option 003
20 Hz	20 Hz	20 Hz	20 Hz
400 Hz	400 Hz	400 Hz	400 Hz
1740 Hz ¹	3100 Hz	2000 Hz ²	3100 Hz
—	Psophometric Noise Weighting	—	C-Message Noise Weighting

1. Psophometric Equivalent Noise Weighting Filter

2. C-Message Equivalent Noise Weighting Filter

Adjacent channel rejection: 75 dB minimum at ± 2850 Hz., 3100 Hz bw.

Passband flatness: $\pm .3$ dB.

Amplitude

Measurement range: +20 to -130 dBm.

Amplitude resolution: .01 dB.

Level accuracy: 10 dB autorange, low distortion mode, after calibration. 20 Hz and 400 Hz BW below -80 dBm.

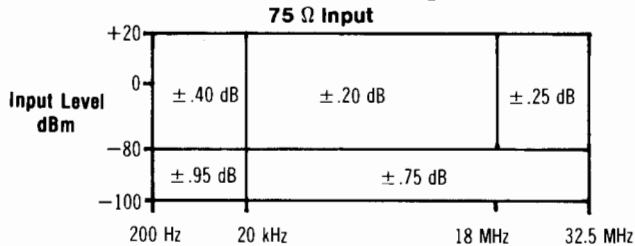

124 Ω Input (3586B): ± 0.8 dB, 4 kHz to 10 kHz; $\pm .35$ dB, 50 kHz to 5 MHz; $\pm .50$ dB, 10 kHz to 50 kHz, and 5 MHz to 10 MHz for +20 to -80 dBm.

135 Ω/150 Ω input (3586A or B): ± 0.6 dB, 4 kHz to 10 kHz; $\pm .35$ dB 50 kHz to 1 MHz, $\pm .50$ dB 10 kHz to 50 kHz for +20 to -80 dBm.

600 Ω input (3586 A/B): $\pm .35$ dB 200 Hz to 108 kHz for +20 to -80 dBm.

Level accuracy: 100 dB range (after calibration): add correction to 10 dB autorange accuracy for dB below full scale. (Not required when in 10 dB autorange).

dB Below Full Scale	Accuracy Correction
0 to -20 dB	$\pm .25$ dB
-20 to -40 dB	$\pm .50$ dB
-40 to -80 dB	± 2.0 dB

Dynamic Range

Spurious Responses

Image rejection (100-132 MHz): -80 dBc.

IF rejection: 15625 Hz, -80 dBc; 50 MHz, -60 dBc.

Non-harmonic spurious signals: > 1600 Hz offset, -80 dBc; 300 Hz to 1600 Hz offset, -75 dBc

Distortion

Harmonic distortion: -70 dB below full scale (>4 kHz on 75 Ω and 600 Ω inputs), low distortion mode.

Intermodulation distortion: 60 dB below full scale, 200 Hz to 50 kHz offset; 70 dB below full scale, 50 kHz to 1 MHz offset.

Wideband power accuracy: after calibration, 100 dB range, averaging on, -45 to +20 dBm.

± 2.0 dB	± 1.0 dB	± 2.0 dB
200 Hz	20 kHz	10 MHz
		32.5 MHz

Noise Floor (full scale setting -35 to -120 dBm)

Frequency	Bandwidth	Noise Level
100 kHz to 32.5 MHz	3100, 1740, 2000 Hz	-116 dBm
	20 Hz, 400 Hz	-120 dBm
10 kHz to 100 kHz	All	-105 dBm

The noise floor for full scale settings of -30 to +24 dBm will be 80 dB below full scale for > 100 kHz, or 60 dB below full scale for < 100 kHz.

Signal Inputs

Model	Impedance	Frequency	Mating Connector
3586A	75 ohms unbalanced	50 Hz to 32.5 MHz	BNC
	150 ohms balanced	4 kHz to 1 MHz	Siemens 3-prong
	600 ohms balanced	50 Hz to 108 kHz	9 Rel 6 AC
3586B	75 ohms unbalanced	50 Hz to 32.5 MHz	WECO 439/440A
	124 ohms balanced	4 kHz to 10 MHz	WECO 443A
	135 ohms balanced	4 kHz to 1 MHz	WECO 241A
	600 ohms balanced	50 Hz to 108 kHz	WECO 310

Connector Options

Opt 001 (3586A): 75 ohms mates with Siemens 1.6/5.6 mm coaxial.

Opt 001 (3586B): 75 ohms mates with WECO 358A.
124 ohms mates with WECO 372A.

(Contact local sales office for other special connectors.)

Return loss: -30 dB (50/75 Ω); -25 dB (600 Ω).

Balance

Input	Frequency	Balance
124 Ω	10 kHz to 10 MHz	-36 dB
135 Ω or 150 Ω	10 kHz to 1 MHz	-36 dB
600 Ω	50 Hz to 108 kHz	-40 dB

Demodulated Audio Output

Output Level: 0 dBm into a 600 Ω load, adjustable.

Output Connector: mates with WECO 347A.

Transmission Impairments Option 003

Adds transmission impairment measurement capability to standard instrument. Measures 2 band phase jitter, noise with tone, single level impulse noise and weighted noise at voice channel and carrier frequencies. Compatible with N. American (Bell) or CCITT standards.

Additional Options

3586A (CCITT)

Opt 001: 75 Ω input connector option. Siemens 1.6/5.6 mm coaxial connector replaces BNC.

Opt 004: High Stability Frequency reference 10 MHz oven stabilized reference oscillator improves frequency stability to $\pm 2 \times 10^{-7}$ /year.

3586B (N. American)

Opt 001: 75 Ω and 124 Ω input connector option. Changes 75 Ω input connector to mate with WECO 358A and 124 Ω input to mate with WECO 372A.

Opt 002: Psophometric equivalent noise filter option. Changes 2000 Hz filter (C-message equivalent) to 1740 Hz (Psophometric equivalent). Not available with opt 003.

Opt 004: High Stability Frequency reference. Same as Opt 004-3586A

Auxiliary Signal Inputs/Outputs

Tracking generator: 0 dBm rear panel tracking output.

External reference input: 1 MHz, 10 MHz or sub-harmonic input.

Reference output: 10 MHz, +8 dBm output.



TELECOMMUNICATIONS TEST EQUIPMENT

Selective Level Meter / Synthesizer

Models 3586A/B and 3336A/B (cont.)

Probe power: front panel DC output for HP active high impedance accessory probes.

HP-IB interface: rear panel interface meeting IEEE 488-1978 for remote operation. Used for tracking synthesizer interface.

Additional outputs: rear panel demodulated audio; phase jitter meter.

General

Operating Environment

Temperature: 0° to 55°C.

Relative humidity: 95%, 0° to 40°C.

Altitude: ≤15,000 ft; ≤4600 meters.

Storage Environment

Temperature: -40°C to 75°C.

Altitude: ≤50,000 ft; ≤15,240 metres.

Power: 100/120/220/240 V, +5%, -10% 48 to 66 Hz, 150 VA.

Weight: 23 kg (50 lbs) net; 30 kg (65 lbs) shipping.

Size: 177 mm H x 425.5 mm W x 466.7 mm D (7" x 16.75" x 18.38")

3336 A & B Abbreviated Specifications

(See data sheet or manual for complete specifications)

Frequency

Frequency Range of Signal Outputs

Signal Output	3336A	3336B
75 Ω Unbalanced	10 Hz to 20.999 999 999 MHz	
124 Ω Balanced		10 kHz to 10.999 999 999 MHz
135 Ω Balanced		10 kHz to 2.099 999 999 MHz
150 Ω Balanced	10 kHz to 2.099 999 999 MHz	
600 Ω Balanced	200 Hz to 109.999 999 kHz	

All balanced outputs are usable over wider frequency ranges but are not specified in under and overrange operation.

Resolution: 1 μm for frequencies < 100 kHz, 1 mHz for frequencies ≥ 100 kHz.

Aging rate: (instruments without option 004): ± 5 x 10⁻⁶/year (20° to 30°C).

Warm-up time: 30 minutes.

Amplitude

Range: 75 and 600 Ω outputs: -72.99 to +7.00 dBm.

124, 135 and 150 Ω outputs: -78.23 to +1.76 dBm.

Level accuracy, 20° to 30°C

75 Ω Output

dBm	± .15 dB		
+7.00			
-3.00	± .25 dB	± .30 dB	± .35 dB
-13.00	± .30 dB	± .35 dB	± .40 dB
-33.00	± .35 dB	± .40 dB	± .45 dB
-72.99			
	10Hz	10MHz	10MHz 20.9MHz

75 Ω Output with Option 005*

dBm	± .12 dB
+7.00	
-3.00	± .16 dB
-13.00	± .18 dB
-33.00	± .22 dB
-72.99	
	10 Hz
	20.9 MHz

*high accuracy attenuator

124 Ω output: 50 kHz to 10.9 MHz ± .15 dB -8.23 to 1.76 dBm, ± 0.3 dB -18.23 to -8.24 dBm, ± .35 dB -38.23 to -18.24 dBm ± .4 dB -78.23 to -38.24 dBm.

135 Ω / 150 Ω output: 10 kHz to 2.09 MHz, ± .17 dB -8.23 to +1.76 dBm, ± .32 dB -18.23 to -8.24 dBm, ± .37 dB -38.23 to -18.24 dBm, ± .42 dB -78.23 to -38.24 dBm.

600 Ω output: 200 Hz to 109.9 kHz, ± .30 dB -3.00 to +7.00 dBm / ± .40 dB -13.00 to 2.99 dBm, ± .45 dB -33.00 to -12.99 dBm ± .50 dB -72.99 to -32.99 dBm.

1. Add ± 0.3 dB for 0° to 55°C operation.

2. Warm-up time is 30 minutes.

Amplitude blanking: < -85 dBm output during blanking

Spectral Purity

Phase noise: < -72 dB, Models 3336A and 3336B, for a 3 kHz band, 2 kHz either side of a 20 MHz carrier.

Harmonic level: -35 dB, 10 Hz to 30 Hz; -50 dB, 30 Hz to 50 Hz; -60 dB, 50 Hz to 1 MHz; -55 dB, 1 MHz to 5 MHz; -50 dB, 5 MHz to 20 MHz.

Spurious: all non-harmonically related signals will be more than 70 dB below the fundamental or -100 dBm (-115 dBm with option 005 except 150 or 600 Ω), whichever is greater.

Phase Offset

Range: ± 719.9° with respect to arbitrary starting phase or assigned zero phase.

Resolution: 0.1°.

Increment accuracy: ± 0.2°

Ambient stability: ± 1.0 degree of phase per degree C

Frequency Sweep

Sweep time: linear sweep, 0.01 s to 99.99 s, single log sweep, 2 s to 99.99 s, continuous log sweep, 0.1 s to 99.99 s

Maximum sweep width: specified frequency range of selected output

Minimum sweep width: log sweep, 1 decade; linear sweep, minimum sweepwidth (Hz) = 0.1 (Hz/s) x sweep time(s).

Phase continuity: sweep is phase continuous over full frequency range.

Sweep flatness: ± 0.15 dB, fast leveling, 10 kHz to 20 MHz, 0.03 s sweep time; ± 0.15 dB, normal leveling, 50 Hz to 1 MHz, 0.5 s sweep time.

Amplitude modulation: modulation depth, 0 to 100%. Modulation frequency range, 50 Hz to 50 kHz.

Phase modulation: range, 0 to ± 850°. Linearity, ± 0.5% from best fit straight line. Modulation frequency range, dc to 5 kHz.

External leveling: input from an external voltage source to regulate the signal amplitude at a remote point.

Options

Option 001, 3336A/B Synthesizer/Level Generator

1.6/5.6 mm 75 Ω input, (3336A). 75 Ω mates with WECO 358A, (3336B). 124 Ω connector mates with WECO 372A, (3336B).

Option 004, High Stability Frequency Reference

Aging rate: ± 5 x 10⁻⁸/week after 72 hours continuous operation ± 1 x 10⁻⁷/month after 15 days continuous operation.

Ambient stability: ± 5 x 10⁻⁷ maximum, 0° to 55°C.

Option 005, high accuracy attenuator: improves level accuracy and spurious level. See main specifications.

General

Operating Environment

Temperature: 0° to 55°C.

Relative humidity: ≤ 85%, 0° to 40°C.

Altitude: ≤ 15,000 ft., ≤ 4600 meters.

Storage Environment

Temperature: -50° to +65°C.

Altitude: ≤ 50,000 ft., ≤ 15,240 meters.

Power requirements: 100/120/220/240 V, +5%, -10%, 48 to 66 Hz, 60 VA, (100 VA with all options), 10 VA standby.

Size: 132.6 mm high x 425.5 mm wide x 425.5 mm deep; (5¼" x 16¾" x 16¾")

Weight: Net wt., 10 kg. (22 lbs). Shipping wt., 15.5 kg. (34 lbs).

Ordering Information

3586A Selective Level Meter (CCITT)

Opt 001: 1.6/5.6 mm 75 Ω Connector

Opt 003: Transmission Impairments Option

Opt 004: High Stability Frequency Reference

3586B Selective Level Meter (N. American)

Opt 001: 75 Ω Connector mates with WECO 358A

and 124 Ω Connector mates with WECO 372A

Opt 002: 1740 Hz Equivalent Noise Bandwidth Filter Replaces 2000 Hz. Not available with opt 003

Opt 003: Transmission Impairments Option

Opt 004: Same as 3586A

3336A Synthesizer/Level Generator (CCITT)

Opt 001: 1.6/5.6 mm 75 Ω Connector

Opt 004: High Stability Frequency Reference

Opt 005: High Precision Attenuator

3336B Synthesizer/Level Generator (N. American)

Opt 001: 75 Ω WECO 358A, 124 Ω WECO 372A

Opt 004, 005: Same as 3336A

TELECOMMUNICATIONS TEST EQUIPMENT

Selective Level Measuring System

Model 3046A/B

557



- Low cost FDM surveillance
- Stored CCITT or Bell FDM plans
- Synthesizer frequency accuracy

- 0.2 dB amplitude accuracy
- Voice channel impairments
- Plotting and storage of data



Introduction

The 3046A/B systems are designed to automate measurements made on Frequency Division Multiplex (FDM) systems. These include tests such as pilot levels, carrier leaks and slot noise. The system, with all of its measurement power, requires no computer background to operate. Surveillance programs are configured simply by making choices from a series of measurement menus. The 3046A is designed for CCITT applications, while the 3046B meets North American (Bell) requirements.

This system is ideal for automating surveillance and routine maintenance on a local basis for small to medium capacity systems. Hewlett-Packard also provides automatic test equipment for large capacity FDM systems, using a distributed approach. See page 563 for a description of these automatic test systems. With a distributed system, remote selective level meters (SLMs) can be monitored from a central computer. With a local system such as the 3046A/B, each SLM and computer are independent, making installation and operation easier, and the system more mobile.

System Configuration

A standard 3046A/B consists of a 3586A/B Selective Level Meter with Transmission Impairments, and two copies of the appropriate system software, contained on data cartridges. An HP-85 controller is also required, and may be ordered as part of the system. A minimum controller configuration includes the HP-85F with 82903A memory expansion and 00085-156004 Matrix ROM.

System software consists of FDM surveillance programs with stored CCITT (3046A) or Bell (3046B) plans, and system test software. The system test software can be used to verify proper system

operation and to help identify the faulty component in case of a failure.

For applications requiring a precision signal source, a 3336A/B Synthesizer/Level Generator can be added to the system. A 0 dBm tracking source is standard with the 3586A/B.

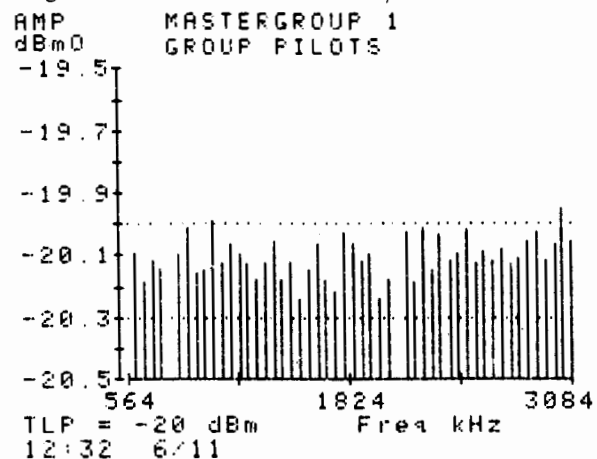

Tabular and Graphic Outputs

An automatic system will collect large amounts of data in a short time, making effective presentation of the results vital. In addition to a variety of tabular listing formats, the Selective Level

TELECOMMUNICATIONS TEST EQUIPMENT

Selective Level Measuring System

Model 3046A/B (cont.)

Measuring (SLM) System provides graphics—the ability to plot measured results. A plot of hundreds of data points can be analyzed in seconds, providing real insight into the condition of the system. With only a tabular listing, interpretation of hundreds of data points is difficult if not impossible. An active marker is provided to read the amplitude of any point on the graph to 0.01 dB resolution, and also list FDM number and frequency.

Storage of Tests and Data

Tests are performed with an automatic system in much the same way they are done manually. First, the measurement parameters (frequency, bandwidth, etc.) are set, and then the measurement is made. The SLM System provides for storage of test parameters on the computer's built-in tape. With this feature, often used test set-ups can simply be recalled from tape, rather than having to be re-entered each time the test is run. In addition, a program can be stored in a file that will load and run when power to the computer is cycled. In this way, a complicated series of tests can be run simply by turning the computer off and then on.

The system can also store measured data for future reference. Short term storage is automatic and has a capacity of 600 readings. This means that measured data can be retrieved any time after a test has been run. If an overnight test were run with only errors printed, this feature would allow printing or plotting of all the data in the morning.

Permanent storage on tape is also provided. This storage allows comparison of today's readings with those taken weeks or months earlier (limit is 600 readings). Data stored includes test limits, TLP, and the time of day and date when the measurement was made.

Timed Measurements

Every printout of test results includes time from turn on or time of day, and the date. The system also provides for delayed start of test and/or repetition of the test at timed intervals. This makes it easy to run a test at night or over a weekend, and to monitor system performance over time.

Provision for Custom Plans

An "array sweep" is available for testing of non-standard FDM plans. Each of four arrays has a capacity of 100 custom frequencies. Carrier tests can be performed at each test frequency, tested against limits and plotted or printed. Once an array of custom frequencies and the test at each is entered, it can be stored on tape for easy access.

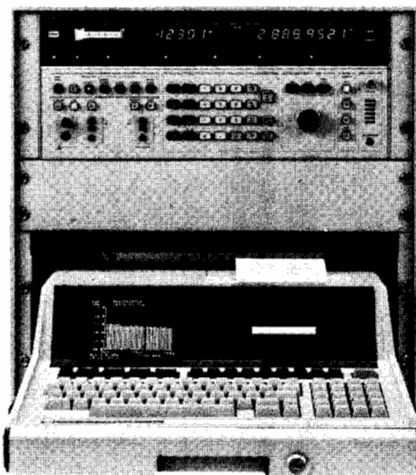

Option 400 cabinet with locking drawer

Recommended Accessories

Disk drive: A disk drive, such as the HP 82901M or 9121D provides much faster access to programs and data. This is highly recommended if the level of system interaction is expected to be high. These drives interface the system via HP-IB, and require a Mass Storage ROM p/n 00085-15001 (HP-IB cable not supplied; ROM included with 85B controller only.)

Access switch: An access switch and switch controller can be added to the system with simple program modifications. The recommended controller is the HP 3755A, with several compatible switches available.

General

System Specifications

System accuracy specifications are identical to those of the 3586A/B and 3336A/B, see pages 564-566.

Measurement speed: 0.5 seconds/reading with no range change; 1.3 seconds/reading with range change; 3.3 seconds/reading with range change and Auto-cal.

System Performance

FDM Carrier Tests

Pilots

3046A (CCITT): Group, Supergroup, Mastergroup, Super-mastergroup, and Hypergroup

3046B (North American): Group, Supergroup and Mastergroup pilots. Non-standard pilots can also be measured.

Carrier leaks: Channel, Group and Supergroup.

Test tones: 1010 Hz or 800 Hz (3046A) or 1004 Hz (3046B), and custom tones

Signalling tones: 2600 Hz (3046B)

Channel Noise and Slot Noise

3046A: Flat or Psophometric weighting

3046B: Flat or C-Message weighting

Other Tests

Transmission Impairments

Phase Jitter

Weighted Noise with 3100 Hz channel filter

Noise with Tone (notched noise)

Impulse noise can be measured and graphed over any period of time up to 90 minutes

Spot frequency: in the spot frequency mode, the 3046 can measure and print the level at a single frequency. The point to be measured can be defined by frequency or FDM number. Wide band power can also be measured and printed out in this mode.

System verification: the system verification program verifies operation of the 3586A/B and the 3336A/B, and can be used to locate the source of a hardware failure.

Physical Parameters

Temperature: 5 to 40°C

Relative humidity: 95%, 0 to 40°C

Altitude: ≤4600 meters, 15,000 feet

Ordering Information

3046S Selective Level Measuring System

By ordering the system instrumentation and controller under this model number, total system compatibility is insured.

3046A SLM System Instrumentation and Software (CCITT)

3046B SLM System Instrumentation and Software (Bell)

001: Special Connector (3586A/B Option 001)

004: High Stability Frequency Reference (3586A/B Option 004)

100: Add 3336A/B Synthesizer/Level Generator

101: Special Connector (3336A/B Option 001)

104: High Stability Frequency Reference (3336A/B Option 004)

105: High Accuracy Attenuator (3336A/B Option 005)

400: Locking Cabinet for Standard System

450: Locking Cabinet for System with Synthesizer

480: 220 V Operation

85F Controller configurations are priced beginning

Consult the 3046S System Configuration Guide for further details.

TELECOMMUNICATIONS TEST EQUIPMENT

Baseband Analyzer, Baseband Analyzer System Software

Models 3724A, 3725A, 3726A, 37018A, 37018B

559



- Automatic noise power ratio scan of up to four slot frequencies
- SLMS scan routines with variable violation limits
- Spectrum analysis for spurious signal identification

- BB frequency response—locally or end to end with storage and normalisation
- Broadband power down to -70 dBm
- Easy conversion between level measurement units

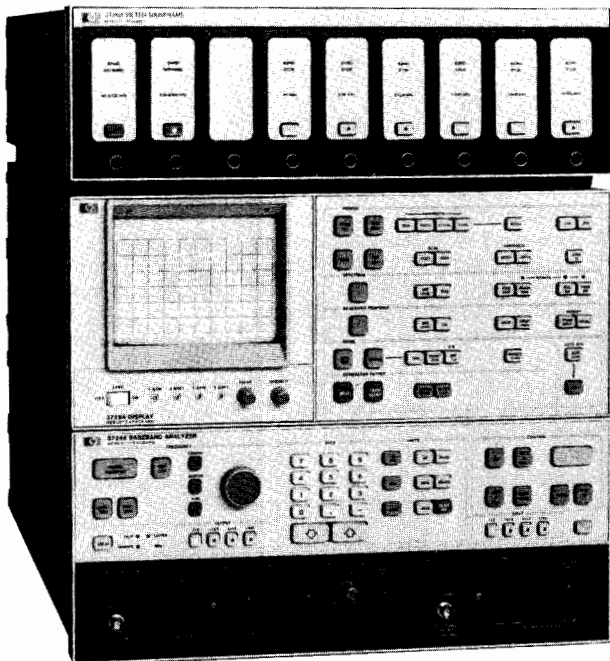

3726A Filter Mainframe
with 37264A Band Defining Filter
and 37265A Band Stop Filter
plug-ins
3725A Display
3724A Baseband Analyzer



Baseband Analyzer

A new approach to microwave radio maintenance, the 3724A/3725A/3726A Baseband Analyzer provides in a single convenient, transportable package, all the qualitative measurements commonly performed on FDM microwave radio systems.

The full capability of the Baseband Analyzer covers measurements traditionally performed by stand-alone products such as a Selective Level Measuring Set (SLMS), Broadband Power Meter, Spectrum Analyzer, Tracking Generator, and White Noise Measuring Set. For the first time, these instruments have been integrated into a single product offering state-of-the-art features for ease-of-use, high performance, and cost effectiveness.

This measurement capability is enhanced by the ability to make complementary measurements on the same signal. For example, a spurious tone found using the Spectrum Analysis mode may have both its level and frequency accurately measured by changing to the SLMS mode. During the changeover, the tuned frequency is automatically retained.

All measurement results appear on a CRT in both analog and digital form, as appropriate. A hard copy of the information on the screen may be obtained using an X-Y plotter or a printer plotter via the HP-IB. No external controller is required for this function.

For portability, the Baseband Analyzer is manufactured in three separate cabinets. The basic instrument comprises two cabinets—the 3724A Baseband Analyzer and the 3725A Display module. Together they provide all the measurement capability except white noise generation. For white noise loading the third cabinet, the 3726A Filter Mainframe, must be added. The 3726A houses the white noise source, the 37264A Band Defining Filter plug-ins, and the 37265A Band Stop Filter plug-ins. Various bandwidths and frequencies to comply with CCIR, CCITT, Intelsat, and Bell recommendations can be provided as options. For the majority of white noise loading applications band pass filters, as required by conventional white noise receivers, are not required. However, if a noise power ratio performance better than 67 dB is required then 37266A Band Pass Filter plug-ins can be installed, offering a further 10 dB improvement in NPR.

Measurement Summary

Level Measurements

Make accurate level and frequency measurements of pilots, carrier leaks, channel power, spurious tones, and other measurements associated with Frequency Division Multiplex (Carrier) systems. Automatic scans can be made using the Scan and High Level User routines.

Wideband

Frequency range: 20 Hz to 18.6 MHz.

Power range: ± 20 dBm to -76 dBm.

Selective

Measurement bandwidths: 40 Hz; 400 Hz; 1.74 kHz; 3.1 kHz; psophometric; 'C'-message.

Frequency range: 50 Hz to 18.6 MHz, synthesizer tuned to 10 Hz resolution.

Power range: $+20$ dBm to <-130 dBm.

Spectrum Analysis

Make measurements on system traffic to check occupancy, or on unloaded systems to check for spurious signals. Automatic or manual coupled controls ensure error free measurements along with flexibility. Traces can be digitally stored and at a later time recalled for visual comparisons.

Spectrum Analysis

Frequency range: 100 Hz to 20 MHz.

Amplitude range (2 dB or 10 dB/cm): $+20$ dBm to -130 dBm.

Resolution bandwidth: 10 kHz to 100 Hz.

BB Frequency Response Measurements

There are three methods of making frequency response measurements with the Baseband Analyzer, i.e. using the Level Measurement, Spectrum, or BB Response modes in conjunction with the tracking generator output. The BB Response mode allows automatic local or end-to-end swept measurements to be made and provides trace storage and normalization.

Tracking Generator

Frequency range: 300 Hz to 18.6 MHz.

Amplitude range: $+6$ dBm to -60 dBm.

Flatness: <0.2 dB.

Harmonics and spurious: <-40 dB on output level.



TELECOMMUNICATIONS TEST EQUIPMENT

Baseband Analyzer, Baseband Analyzer System Software

Models 3724A, 3725A, 3726A, 37018A, 37018B (cont.)

White Noise Measurements

White noise measurements allow the overall performance of a radio link to be assessed using test signals which simulate normal traffic. The test signal used is white noise, band limited to correspond to the baseband bandwidth of the particular radio under test. The Baseband Analyzer conforms to all relevant CCIR and CCITT Recommendations and measures in a wide range of units. Auto mode allows automatic scan of up to four slots even on an end-to-end basis.

White Noise Measurements

Frequency range: for measurements on systems with 12 to 2700 channels.

Noise power ratio range: 0 to 67 dB.

Signal to noise range: -18.8 to -85 dBm0p (1.3×10^7 to 3.16 pW0p); 72 to 5 dBmC0 (1.66×10^7 to 4 pW0c).

Noise power range: +12 to -60 dBm.

A full range of band defining and slot filters is available, consult Data Sheet.

Options

3724A Baseband Analyzer

Input/Output	Standard	Option 003 N/C	Option 004 N/C
75Ω	BNC	Siemens 1.6 mm	WECO 477B
124Ω	Blank	Blank	WECO 477B
135Ω/150Ω	Siemens 3-pin Bal	Siemens 3-pin Bal	Large 223A
600Ω Audio	Siemens 3-pin Bal	Siemens 3-pin Bal	Large 310
Head Phone	0.75" Banana	0.75" Banana	0.75" Banana

3726A Filter Mainframe

301: delete noise source (for systems where more than nine filters are required). N.B. Up to three 3726A Filter Mainframes can be controlled by one 3724A Baseband Analyzer.

37264A Band Defining Filter

311: 60 to 300 kHz. **315:** 60 to 4100 kHz. **318:** 316 to 5600 kHz.
312: 60 to 552 kHz. **316:** 316 to 4100 kHz. **319:** 316 to 8160 kHz.
313: 60 to 1296 kHz. **317:** 60 to 5600 kHz. **320:** 316 to 12360 kHz.
314: 60 to 2600 kHz.

N.B. All nine plug-in compartments of the 3726A Filter Mainframe must be filled for correct operation. The 3726A Dummy Plug-in should be ordered to fill any empty plug-in compartments.

37265A Band Stop Filter

311: 70 kHz. **314:** 1248 kHz. **317:** 5340 kHz.
312: 270 kHz. **315:** 2438 kHz. **318:** 7600 kHz.
313: 534 kHz. **316:** 3886 kHz. **319:** 11700 kHz.

37266A Band Pass Filter

Only required if a noise power ratio performance of better than 67 dB is required. NPR performance of instrument is extended to 77 dB when Band Pass Filter fitted. These filters must be housed in separate 3726A Filter Mainframe.

311: 70 kHz. **314:** 1248 kHz. **317:** 5340 kHz.
312: 270 kHz. **315:** 2438 kHz. **318:** 7600 kHz.
313: 534 kHz. **316:** 3886 kHz. **319:** 11700 kHz.

N.B. Consult Baseband Analyzer data sheet for Band Defining, Band Stop, and Band Pass Filters to meet Intelsat and Bell requirements.

37267A Adapter Case (for Marconi filters)

311: high or low pass.
313: band pass (including 750 Ω/75 Ω transformer).
314: band stop.

37268A Dummy Plug-in

Must be used to fill any empty plug-in compartments on the 3726A Filter Mainframe.

37269A Plug-in with Front Panel Input Connector

To be used in conjunction with 37266A Band Pass Filter.

003: Siemens 1.6 mm connector.

004: WECO 477B connector.

Ordering Information

3724A Baseband Analyzer

3725A Display

3726A Filter Mainframe

- Automated baseband measurements with presentation of white noise loading curves
- Measurement sequences easily and quickly created
- Measurement results checked against stored tolerances

Baseband Analyzer System Software

The Baseband Analyzer System Software together with the necessary hardware, makes automatically-controlled baseband measurements associated with the quality evaluation of microwave radio communications systems. The software is modular, allowing the first-time user or programmer to add measurement capability, different output formats, etc, with minimal effort. The software guides the user via simple prompts through the initial set-up, calibration, measurement and output sequences.

Two user-oriented system software packages are available for the Baseband Analyzer (BBA). The 37018A package is intended for applications involving a single BBA such as in manufacturing or in maintenance where a portable test system is required. The 37018B is designed for controlling two BBA's working in remote locations and has the ability to operate with appropriate access switching.

Measurement Results

Considerable time saving in production test and quality assurance can be achieved by using the BBA in conjunction with the 37018A to produce a complete sequence of performance curves. Each product tested can be fully evaluated and hard copy verification of its performance can easily be provided.

37018A Configuration

Operation of the software requires the following:

HP85 Personal Computer, with
 82937A HP-IB Interface
 82903A 16k Memory Module
 82936A ROM Drawer
 00085-15002 Plotter Printer ROM
 00085-15003 Input/Output ROM
 3724A/3725A Baseband Analyzer

To make NPR and signal-to-noise measurements, the BBA must be equipped with the 3726A Filter Mainframe and appropriate filters. An external page printer such as the 2631B or 82905A and an external plotter such as the 7225A can be added easily to allow high quality printed and plotted outputs. These additions only require changes to the address assignments in the 'Autost' program.

37018B Configuration

Operation of the software requires the following:

HP87XM Personal Computer, with
 82937A HP-IB Interface
 82936A ROM Drawer
 00087-15002 Plotter ROM
 00087-15003 Input/Output ROM
 Mass Storage (82902M Single Drive 5¼ Disc Drive or 82901M Double Drive 5¼ Disc Drive)
 3724A/3725A Baseband Analyzer (to make NPR and signal-to-noise measurements, the BBA must be equipped with the 3726A Filter Mainframe and appropriate filters)

Printers (82905A or B Printer
 2631G Graphics Printer
 2671G Graphics Printer
 2673G Intelligent Graphics Printer)
 Access Switching (3755A Switch Controller
 3756A 90 MHz Bi-directional Switch)

Ordering Information

37018A Baseband Analyzer System Software

37018B Baseband Analyzer System Software

TELECOMMUNICATIONS TEST EQUIPMENT

70 MHz Modulator/Demodulator

Model 3717A



- Up to 5 pre-/de-emphasis networks
- Video and telephony inputs and outputs
- Service channel provided

- Built-in 15 dB open-ended attenuator
- Optional HP-IB control
- Optional balanced BB input and output

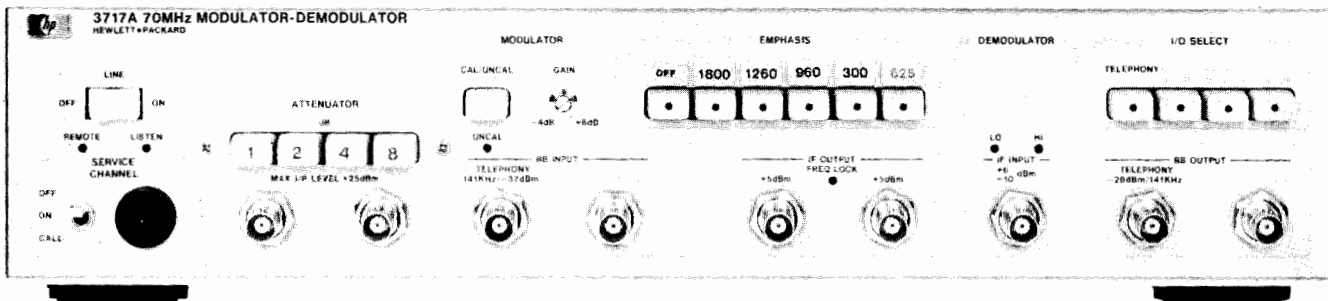

The 3717A 70 MHz Modulator/Demodulator can be used in microwave radio link systems to enable BB qualitative measurements to be made at non-demodulating repeater stations.

Standard measurement practice for the alignment and maintenance of microwave radio links involves two specific categories of tests, i.e. swept response measurements and BB qualitative measurements. Normal practice is to align a microwave radio initially by using swept response techniques such as those provided by an MLA. After these measurements have been completed successfully, qualitative measurements such as white noise loading, TV waveform testing, and BB frequency response are performed at the BB terminals of the microwave radio to verify operational performance.

However, the optimum swept response does not always produce the best possible qualitative figure. When this happens it may be necessary to isolate the faulty section by performing qualitative measurements from BB terminal stations to IF repeater stations, or vice versa. To do this, a high quality wideband test modulator or demodulator is required. The 3717A provides this capability.

Specifications Summary

Back-to-Back Performance (telephony)

BB Frequency Response (with or without emphasis)

50 Hz to 10 MHz: ± 0.2 dB.

50 Hz to 20 MHz: ± 3 dB.

Noise Loading Performance

At manual loading for all slots, 70 to 7600 kHz (1800 channels with emphasis): ≤ 25 pWOp (57 dB NPR).

Thermal: mod/demod is thermally dominated and will typically tolerate a 6 dB overload with no degradation.

Spurious Response

300 kHz to 10 MHz: ≤ -72 dBm0.

Back-to-Back Performance (video)

BB Frequency Response

5 Hz to 10 MHz: ± 0.2 dB.

Square wave tilt (50 Hz): $\leq 1.0\%$.

Diff. Gain (4.43 MHz)*: $\leq 0.7\%$.

Diff. Phase (4.43 MHz)*: $\leq 0.7^\circ$.

*Measured on an HP Microwave Link Analyzer with a test tone of 4.43 MHz.

Options

Connector Options—Select Any One.

Std: BNC

003: Siemens small.

004: commercial equivalent of WECO 477B balanced input.

Emphasis networks—up to five may be installed and should be specified with every order. Other emphasis networks are available to special order.

CCIR

011: 24 channel emphasis.

012: 60 channel emphasis.

013: 120 channel emphasis.

014: 300 channel emphasis.

015: 600 channel emphasis.

016: 960 channel emphasis.

017: 1260 channel emphasis.

018: 1800 channel emphasis.

021: 525 line emphasis.

022: 625 line emphasis.

023: 819 line emphasis.

Bell

031: Bell 600 channel emphasis.

032: Bell 900 channel emphasis.

033: Bell 1200 channel emphasis.

034: Bell 1500 channel emphasis.

035: Bell 1800 channel emphasis.

Miscellaneous options

006: deletes Modulator section.

007: deletes Demodulator section.

100: HP-IB.

136: Combination of options 003 and 006.

137: Combination of options 003 and 007.

146: Combination of options 004 and 006.

147: Combination of options 004 and 007.

3717A 70 MHz Modulator/Demodulator



TELECOMMUNICATIONS TEST EQUIPMENT

Microwave Link Analyzers and Accessories

Models 3711A/3712A, 3710A/3702B, 3743A, 3750A

- Test analog and digital radios
- Isolate and characterize causes of intermodulation distortion in wideband FM microwave radios
- Baseband and IF interfaces
- 70/ 140 MHz or 70 MHz only IF capability
- Selectable combinations of BB test tones

70/ 140 MHz IF MLA System

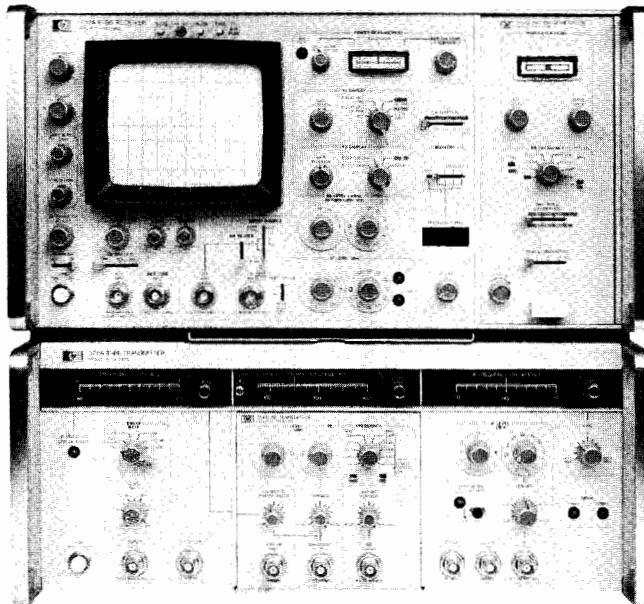

3711A IF/BB Transmitter
3791B BB Transmitter (Plug-in)
3712A IF/BB Receiver
3793B Diff. Phase Detector (Plug-in)

70 MHz IF MLA System



3710A IF/BB Transmitter
3715A or 3716A BB Transmitter (Plug-in)
3702B IF/BB Receiver
3703B or 3705A Group Delay Detector (Plug-in)

Two versions of the Microwave Link Analyzer (MLA) are available: the 70 MHz IF 3710A/3702B System, and the dual 70/140 MHz IF 3711A/3712A System. For microwave radio stations employing both 70 and 140 MHz intermediate frequencies, the dual IF MLA is an economical way of providing a complete range of dedicated measurements at both IF's.

The 3710A/3702B and 3711A/3712A MLA's isolate and characterize causes of intermodulation distortion in wideband microwave radios. They have applications in both analog and digital radio systems. Measurements performed by the MLA's include:

- BB power, gain, and loss
- IF power, gain, and loss
- modulator/demodulator deviation sensitivity
- modulator/demodulator linearity
- modulator/demodulator group delay
- swept IF amplitude response
- swept IF group delay
- swept IF return loss
- BB and IF differential gain (HF linearity)
- BB and IF differential phase (HF group delay)
- BB return loss

When used with the 8620C/86200 Series RF Sweeper system (equipped with the MLA interface option) and the 3730B RF Down Converter, the swept measurements of the basic MLA's can be extended to RF. Pages 564 and 565 give further details about this RF instrumentation (3730B and 8620C).

Apart from the dual 70/140 MHz IF capability, with the full range of measurements available at both frequencies, the 3711A/3712A MLA has many other refinements over earlier systems. These include an improved marker system, an IF input frequency counter, improved input sensitivity at -19 dBm, a slope control, a 16 dB dynamic display range, and X-Y Recorder facilities.

Another major contribution is the provision of an interface for the 8501A Storage-Normalizer. Use of this instrument with the 3711A/3712A MLA provides digital averaging and normalizing facilities. Further, measurement limit masks and adjustment instructions can be displayed on the MLA screen when a desk-top computing controller is used with the Storage-Normalizer.

A series of options are available with the MLA's, including:

- test-tone frequencies
- connectors
- balanced 124 Ω baseband impedance
- sweep frequencies
- variable phase output of sweep signal

Options (3711A/3712A and 3710A/3702B MLA's)

To compile a suitable MLA System for your application, select *one* of the following combinations:

70/140 MHz IF— 3711A/3791B/3712A/3793B.

70 MHz IF with Low- and High-Frequency Test-Tones

3710A/3716A/3702B/3705A.

70 MHz IF with Low-Frequency Test-Tones Only

3710A/3715A/3702B/3703B.

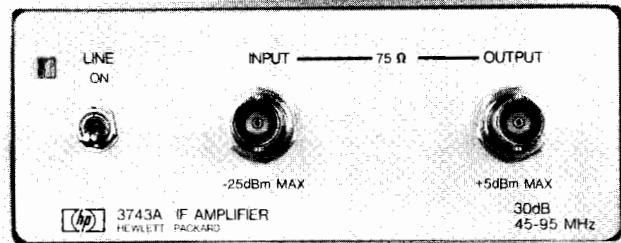

3743A IF Amplifier

Connector Options

(3711A/3791B/3712A/3710A/3716A/3715A/3702B only)

Option	BNC	Siemens Large	Siemens Small	WECO 477B	WECO 560A
Std	•				
002		•			
003			•		
004				•	
005*					•

* Available with 3711A/3791B/3712A only.

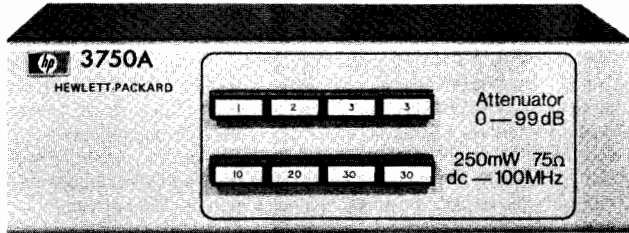

3750A Attenuator

Test-Tone (BB) Options

(3791B/3793B/3716A/3715A/3705A/3703B only)

Options	Test-tone Frequencies											
	83.333 kHz	92.593 kHz	55.556 kHz	2.4 MHz	3.50 MHz	3.58 MHz	4.43 MHz	4.50 MHz	5.60 MHz	8.20 MHz	12.39 MHz	
Std	•											
010		•										
011		•										
012		•										
013	•											
014	•											
016	•											
018	•											
019	•											
021*		•										
022	•											
210*												
211*												
212*												
221*												
3715A/3703B Options												
Std	•											
009		•										

* Available with 3791B/3793B only.

Sweep Frequency Options (3711A/3710A only)

Option	70 Hz	LINE	Opt			
			70 Hz	50 Hz	100 Hz	18 Hz
Std	•	•				
006	•	•	•			
007	•	•		•		
015	•	•			•	

Miscellaneous Options

- 008** (3711A/3710A only) Variable phase sweep output.
- 015** (3793B/3705A only) Additional phase detector bandwidths of 90 and 180 Hz—must be used with 18 Hz sweep rate on 3711A or 3710A IF/BB Transmitter.
- 020** (3712A only) CRT graticule illumination.
- 908** (3711A/3712A/3710A/3702B only) Rack mounting kit.
- 910** Extra manuals.

3743A IF Amplifier

- Improve MLA IF input sensitivity to -40 dBm.
- Frequency range 45 to 95 MHz.
- Group delay <0.3 ns.
- Amplitude flatness <0.2 dB.
- Return loss >26 dB (75 Ω).
- Noise figure ≤8 dB.

3750A Attenuator

- Impedance 75 Ω.
- Attenuation range 0 to 99 dB, in 1 dB steps.
- Frequency range dc to 100 MHz.

Ordering Information

- 70/140 MHz system** (3711A/3791B/3712A/3793B)
- 70 MHz system with low- and high-frequency test-tones** (3710A/3716A/3702B/3705A)
- 70 MHz system with low-frequency test-tones only** (3710A/3715A/3702B/3703B)
- 3743A IF Amplifier**
- 3750A Attenuator**



TELECOMMUNICATIONS TEST EQUIPMENT

RF Down Converter

Model 3730B

- RF to IF frequency conversion
- 1.7 to 14.5 GHz frequency range
- Extends test capability of MLA's to RF
- 70 or 140 MHz IF output

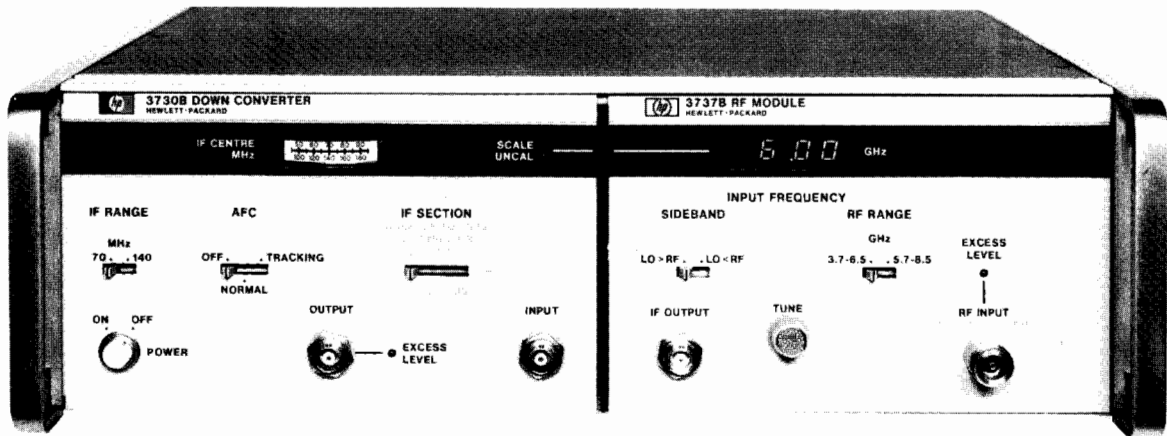

3730B Option 010 Down Converter mainframe with 3737B RF Module plug-in

The 3730B Down Converter and plug-ins provide RF to IF conversion and RF test capabilities for Microwave Link Analyzers (MLA's). The 0.7 to 14.5 GHz RF range is accommodated by a series of local oscillator plug-ins, allowing easy tuning to the desired operating frequency.

The 3730B has dual IF capability which allows the Down Converter to interface with single 70 MHz IF (eg the 3710A/3702B) or dual 70/140 MHz IF (eg the 3711A/3712A) MLA's, or with wide-band demodulators (eg the 3717A) when white noise loading.

A tracking AFC and recovered sweep facility causes the local oscillator in the 3730B to track the incoming swept RF signal, thus almost eliminating the swept component of the IF signal. This feature is particularly useful in wideband applications. It allows the Down Converter to be used in conjunction with an Up Converter and a conventional MLA to perform RF to RF measurements over bandwidths of up to 250 MHz.

The tracking AFC facility also has advantages when operating over conventional measurement bandwidths of a Microwave Link Analyzer. Because of the effective sweep compression of the IF signal, the residual distortions of both the Down Converter and Microwave Link Analyzer receiver are reduced considerably.

Provision has been made for incorporating an isolator in the RF input of the Down Converter. The standard RF input circuit of the 3730B is broadband. However, for some measurement applications, introducing a narrow band isolator can provide substantial benefits, eg improved input return loss, reduced L.O. leakage, improved noise figure and increased input sensitivity.

On a microwave radio route containing a number of repeater stations, the local oscillator can be positioned above or below the carrier frequency and this can vary from repeater station to repeater station. This can cause difficulties when comparing MLA responses between stations due to frequency axis inversion of the swept response. Selecting upper or lower sideband operation on the 3730B overcomes this.

Lengthy runs of RF cable between the Down Converter and the RF test point can generate ripple responses which can mask the true measurement response. To avoid this problem, it is possible to remove the Down Converter plug-in and mount this directly onto a waveguide test point. The plug-in is then supplied with its power and mainframe control signals via an umbilical cable (15609A). The plug-in's IF output is connected to either the 3730B or the measurement system, eg an MLA, via a cable of suitable length. This reduces the possibility of erroneous measurements as only IF signals are transmitted from the test point.

Option 010 of the 3730B incorporates an additional IF section, comprising a 25 dB fixed gain amplifier and a 30 dB stepped attenuator, to ensure that the IF signal level is sufficient to drive most MLA's when operating at RF input levels below -12 dBm. Note that no degradation of the residual performance specifications occurs when this option is fitted.

Specifications

3730B + 3736B/7B/8B/9B

Residual Performance

	50 MHz Sweep Width at 70 MHz centre frequency	100 MHz Sweep Width at 140 MHz centre frequency
Amplitude Response	0.2 dB	0.3 dB
Group Delay	0.2 ns	0.3 ns
Diff Gain (5.6 MHz test tone)	0.3%	0.5%
Diff Phase (5.6 MHz test tone)	0.3°	0.5°

The residual specifications quoted are measured using the FM Sweep Input to reduce the residual contributions of the RF test source, and using storage normalizer techniques to remove MLA receiver contributions. Further improvements in the residual performance can be obtained by utilising the 3730B's unique tracking AFC facility.

Min RF input level: -15 dBm, typically (-40 dBm when Opt 010 is fitted), for correct operation of MLA; however, min input level dependent on input sensitivity of MLA and RF-IF gain conversion of Down Converter (3710A/3702B MLA—min input sensitivity -10 dBm; 3711A/3712A MLA—min input sensitivity -19 dBm).

Size: 141 mm H x 425 mm W x 467 mm D (5.5 x 16.75 x 18.38 in.)

Power supply: 100, 120, 220, or 240V ac, +5 -10%; 48 to 66 Hz; consumption 100 VA max, including plug-in.

Weight: 11.9 kg (26 lb) net, including plug-in.

Temperature range: 0 to 55°C, operating.

Options

010: 25 dB fixed gain amplifier, with 30 dB (10 dB step) attenuator.

Accessories

15600A Isolator: 3.7 to 4.2 GHz.

15601A Isolator: 5.9 to 6.5 GHz.

15602A Isolator: 7.1 to 8.5 GHz.

15603A Isolator: 10.7 to 11.7 GHz.

15609A Remote Extender Cable: 3 metre umbilical cable.

Ordering Information

3730B Down Converter

3736B RF Module 1.7 to 4.2 GHz

3736B H05 RF Module 0.7 to 12.0 GHz (Ext. L.O.)

3737B RF Module 3.7 to 8.5 GHz

3738B RF Module 5.9 to 11.7 GHz

3739B RF Module 10.7 to 14.5 GHz

TELECOMMUNICATIONS TEST EQUIPMENT

RF Sweeper MLA Upconverter Simulation

Models 8350, 8620C, 86200 Series RF Plug-Ins



- MLA upconverter simulator options 0.5 to 18.0 GHz
- Use with MLA or as a general purpose sweeper
- Swept and CW RF source
- Test digital & analog microwave radio systems & components

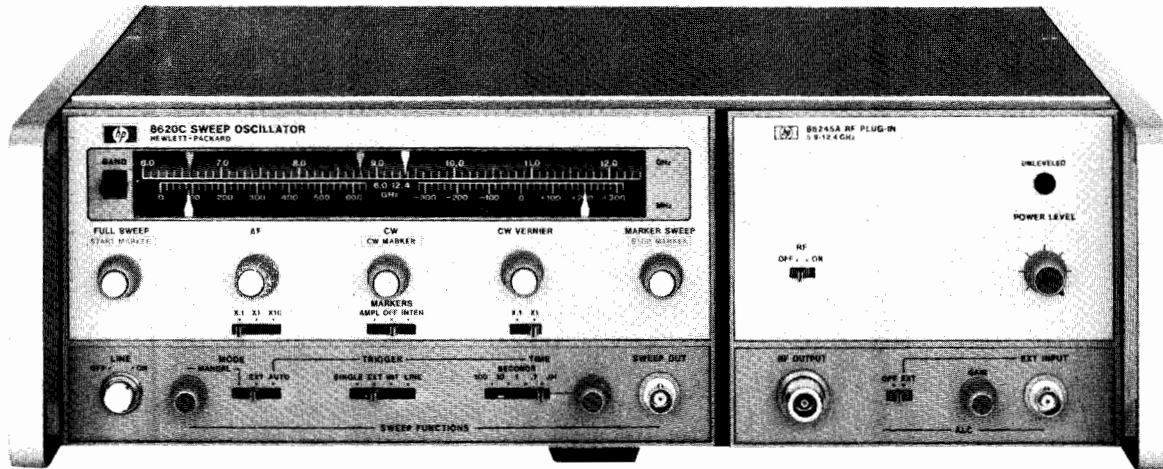

8620C / 86245A

Description

The 8620C Sweep Oscillator and 86200 Series of RF plug-ins provide a high performance, solid state source for Microwave Radio System tests via MLA Upconverter Simulation Options. These permit accurate RF-to-BB, RF-to-IF and RF-to-RF distortion measurements to be made with the 3700 Series MLA Systems. The plug-ins can also be used as standard sweeper plug-ins, with the only basic difference being modified FM circuitry. The RF-to-RF measurements must be made in conjunction with the 3730B RF Down Converter. This allows group delay, linearity, differential gain and phase measurements to be made on RF devices and components within the Microwave Radio System. The 8350 Sweep Oscillator Mainframe is also compatible with the 86200 series MLA option plug-ins through the use of the 11869A Adapter (see page 384).

Specifications

The 8620C/86200 Series MLA Upconverter Simulation Plug-ins are optimized for group delay, linearity, and differential gain and

phase over the specified frequency range. All plug-ins can be used with MLA sweep widths of 100 MHz or less. The following specifications supplement the standard 8620C system specifications (covered on pages 386-391).

Complementary Equipment

8350 Sweeper Mainframe

11869A Adapter

8620C Sweeper Mainframe (required)

To properly interface the 8620C/86200 Series plug-in to the item under test, the following are recommended for optimal performance:

784C Directional Detector (1.7 - 12.4 GHz)

Flatness over any 30 MHz: $< \pm 0.1$ dB

Equivalent source match: typically ≤ 1.5

11675B Leveling Cable Assembly (1.7 - 12.4 GHz)

Group delay: ≤ 0.25 ns p-p (with 1.25 SWR at each end)

MLA Upconverter Simulation Plug-in Specifications (25°C)

Model Number	MLA Option Number	MLA Freq. Range (GHz)	Group Delay (ns) p-p	Linearity (%)	Diff. Gain (%)	Diff. Phase (°)	FM Sens. (MHz/V)
			@277.7 kHz		@5.6 MHz ¹		
			Across Any 30 MHz BW				
86222A/B	H80	0.5-2.4	<3	<2.5	<2.5	<3	N/S
86235A	008	1.7-4.3	<2	<2.0	<2.0	<2	+20
86240C	—	3.6-8.6	<1	<0.5	<0.5	<1	+20
86242D	008	5.9-9.0	<1	<0.5	<0.5	<1	+20
86245A	008	5.9-12.4	<1	<0.5	<0.5	<1	+20
86250D	008	8.0-12.4	<1	<0.5	<0.5	<1	+20
86260A	H82	12.0-18.0	<3	<2.5	<2.5	<3	N/S

¹Except 86222A/B & 86260A which are tested @ 2.4 MHz.

For applications requiring better distortion specifications, HP also offers plug-in systems which include a leveling cable and directional coupler. These systems are available in the following bands: 5.8-6.5 GHz, 7.0-8.6 GHz, 10.7-11.7 GHz, and 12.2-12.7 GHz. The system specifications are as follows:

Group delay @ 500 kHz: < 0.5 ns p-p

Linearity @ 500 kHz: $< 0.25\%$

Flatness: $< \pm 0.1$ dB

For more information consult your local HP Field Engineer.

The options shown after each plug-in provide the special MLA interface capability. Refer to pages 386-391 for details on other RF Sweeper plug-in specifications and options.



TELECOMMUNICATIONS TEST EQUIPMENT

Centralized Remote Access and Test Equipment

Model 37100S

- Centralized testing of private voice-frequency lines improves efficiency
- Modular approach allows large and small offices to be equipped
- User-friendly software means no special skills are required to operate the System
- Cost-effective access and testing, even for small numbers of circuits
- Complete solution from HP: the hardware, software and support to ensure an integrated, one-manufacturer Remote Access and Test System

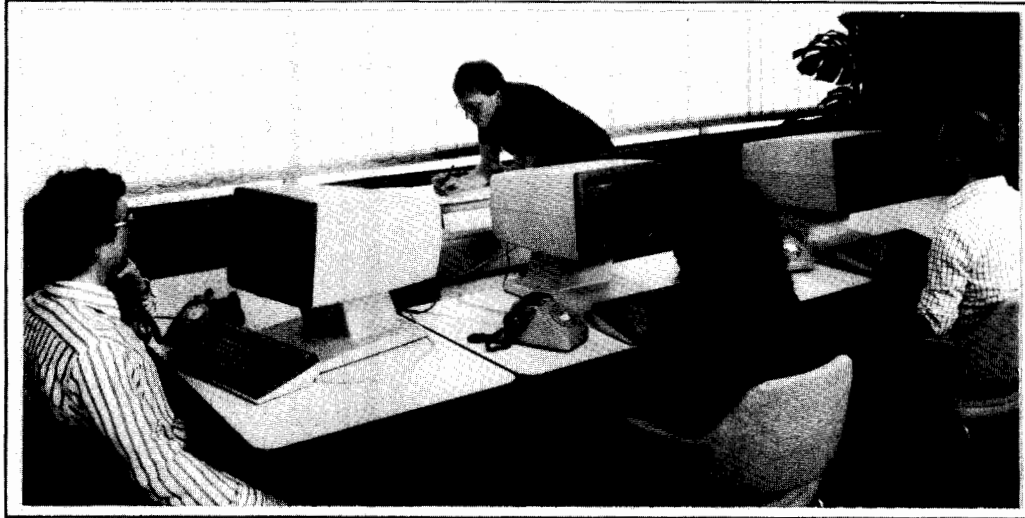

Central site

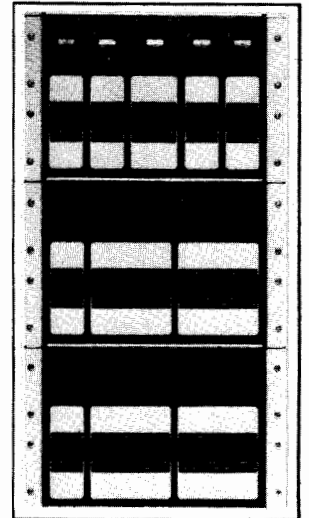

Remote site

The 37100S Centralized Remote Access and Test System provides the hardware and software for nationwide testing and troubleshooting of private voice-frequency lines. Circuits can be accessed and tests carried out at remote sites under control from a central site. Any number of remote sites may be accessed, allowing fast fault isolation to a particular section of the network. This greatly reduces the time taken to restore a faulty circuit.

The 37100S is modular at all levels, providing solutions all the way from large telephone companies with many lines, to the smaller systems required by end-users. The System is designed with expansion in mind: additional circuits, extra test features, more test personnel—all are easily accommodated.

Remote Site Configurations

Three types of module have been designed by HP and provide the basic building blocks of any 37100S System.

Access Module (AM)

The AM consists of a card cage organised as follows:

- Four quadrants each consisting of 2 slots. One slot accepts an Access Card which provides access to 48 2-wire circuits.
- An option slot is provided in each quadrant for either a Jack Access or a Split & Terminate Card.

8-wire 'grab'

Each AM accommodates 192 2-wire circuits, and AM's can be 'chained' together to a maximum of 15 (2880 2-wire circuits) before a Chain Selector is required. Each Access Card (there are 4 in an AM) can make access to a single group of 8 wires from a total of 96; thus, any one of 12 8-wire grabs may be selected. Each 8-wire grab may consist of: 2 4-wire circuits, 4 2-wire circuits, 1 6-wire circuit plus 1 2-wire circuit, or 1 8-wire circuit.

Only the required circuits of the 8-wire grab are accessed: the unaccessed circuits continue through without interference.

Uninterrupted Operation

The connectors for the cards in each quadrant have a make-before-break action. This means that cards can be replaced without breaking the continuity of any circuits.

Test & Measurement Unit (TMU)

The TMU consists of a card cage with space for 9 cards (optionally 12 with an additional motherboard). Up to 4 TMU's can be connected to one chain of AM's. The following features are provided:

- Multimeter measurements—dc/ac voltage and current, resistance and capacitance
- Variable level and frequency signal source
- Flat or weighted level measurements
- Selective level measurements
- Pair selection, splitting and termination
- Crossover, loopback, tip-ring and/or pair reversal
- Audio talk/monitor with automatic gain
- Signalling
- ERL, SRL
- PAR
- Make busy
- External equipment connection

As features are provided on separate cards, only those that are required need be specified—others can be added later.

Chain Selector (CS)

Restrictions on the number of chains of AM's and the number of TMU's can be reduced by the use of the CS.

- Provides an additional level of switching, and interfaces between TMU's and AM's
- The number of chains of AM's and the number of TMU's connected can be adjusted to meet individual requirements
- Up to 64 TMU's can be connected to up to 30 chains of AM's

Four Possible Systems

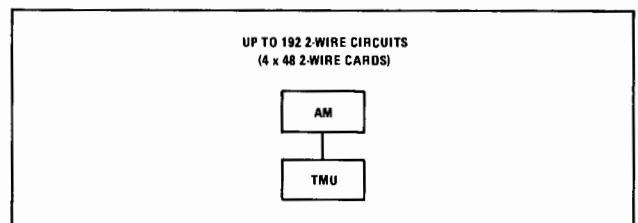

Figure 1. Small System

At small remote sites, it may be sufficient to install only one AM and one TMU. It is not necessary to fully load the AM with Access Cards. For example, if only 96 2-wire circuits are to be accessed, then 2 Access Cards would be sufficient.

TELECOMMUNICATIONS TEST EQUIPMENT

Centralized Remote Access and Test Equipment

Model 37100S

567

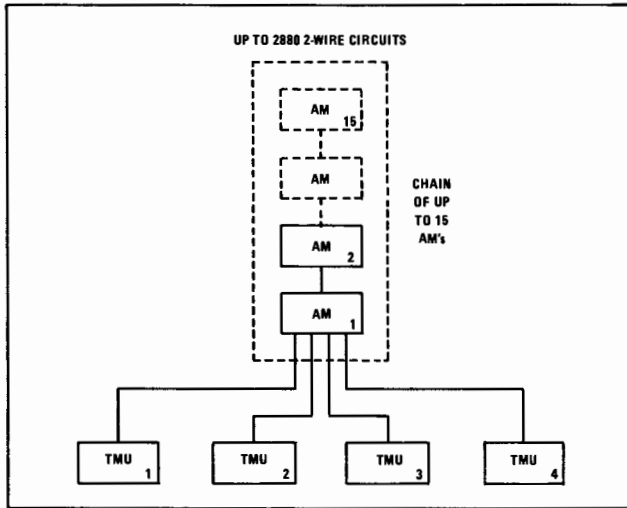

Figure 2. Large System

At large remote sites, the number of AM's is chosen to suit the number of circuits. As in the small system case, it is not necessary to fully load every AM. The number of TMU's chosen depends on the number of technicians who will simultaneously make access to these circuits.

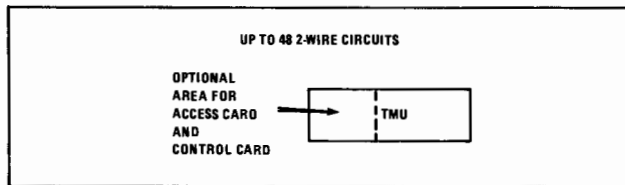

Figure 3. Very small System

At very small remote sites and for some end-users, even one AM cannot be justified. In this case only a TMU is required and one Access Card and one Control Card from the AM range are fitted. This provides a cost-effective solution to very small installations. When the System is expanded, no cards or modules are discarded.

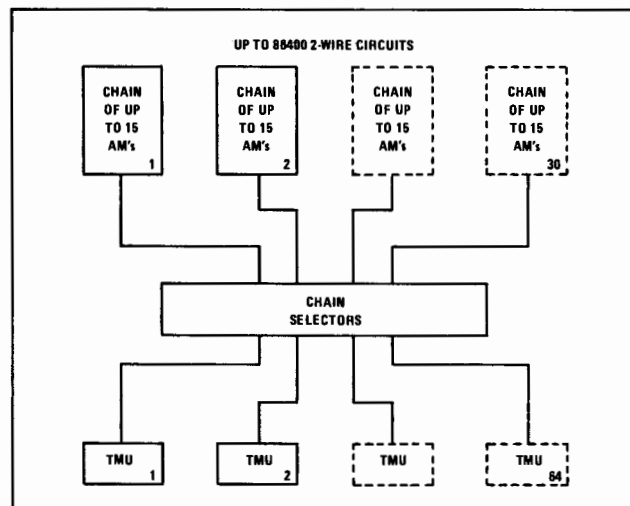

Figure 4. Very large System

For very large Systems with more than 2880 2-wire circuits at any remote site, HP has introduced another level of switching called a Chain Selector (CS). This enables up to 30 chains of AM's to be connected to up to 64 TMU's.

Central Site Configuration

System Control

There are two different ways of driving the System:

Computer Mode

The majority of users will drive the System in computer mode for most of the time. This allows Centralized Remote Access and Test with all of its inherent benefits. User-friendly soft keys and screen graphics combine to provide a technician with the tools needed for fast troubleshooting. Even at the remote sites, a terminal can be attached to a TMU and provides the same power as a terminal at the central site. This means that any circuit at any site connected to the System can be accessed via this terminal. Also, data base updating is feasible at each remote site and circuit records can be modified as soon as changes occur.

An HP 1000 A-Series Computer is used in the 37100S.

Local Mode

There will be occasions when users will not choose to drive the System through the computer. For example, during commissioning of new circuits; when a computer link has still to be established; and where, in the case of an end-user, no computer is specified.

In these cases, Local Mode provides access and test via a terminal connected to a TMU at any remote site. User-friendly screen graphics and soft keys are not available, and circuits can only be accessed at the remote site where the technician is working. However, all the powerful access and test features still apply in this mode.

Distributed System

Very large Systems with many access points can have more than one central site, each with its own computer. These computers communicate with each other over HP's Distributed Systems Network. This allows access to any circuit on the network from any terminal.

Man/Machine Interface

The 37100S uses 8 soft keys (programmable function keys) on the terminal to make the man/machine interface extremely friendly. The technician is asked to make one of 8 choices. On pressing a soft key to indicate his choice, the labels on the screen change. The same 8 soft keys can then be used to make different choices. The technician is guided through a test sequence—the only inputs from the rest of the keyboard are concerned with numerical values and the circuit access points.

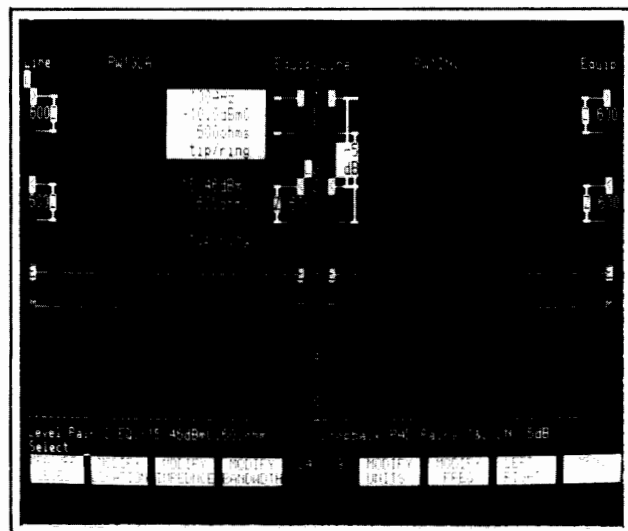

Figure 5. Screen graphics

Full details of the specifications of individual cards and the System in general are contained in the 37100S Data Sheet.



DATA COMMUNICATIONS TEST EQUIPMENT

General Information: Data and Voice Testing

Data and Voice Testing

As user needs place greater demands on data communications networks, system managers have become increasingly concerned about maximizing network availability. Network availability is defined here as the percentage of time that the network is passing data accurately. This not only implies minimizing downtime for maintenance or installation of new hardware or software, but also verifying that network components are performing to specification when the network is functional. It also includes the concept of network efficiency, determined by utilization profiles and other statistical information.

Data Network Testing

There are a wide variety of tests which can be made on a data communications system. Depending on the point in the system at which the tests are made, quite different philosophies and techniques apply. These group conveniently into three areas: protocol, digital, and analog testing (Figure 1).

Protocol analysis is usually concerned with overall network performance, determined through monitoring or simulating network software (protocol and/or data). Digital testing involves measuring modem-channel-modem efficiency in terms such as Bit Error Rate (BER), Block Error Rate (BLER), etc. Analog testing measures the tariffed and other key parameters of the transmission line itself.

The interrelationships of these measurement philosophies are complicated and difficult to understand. For example, how is envelope delay distortion of the line related to the BER or the throughput of the system? Generally speaking, the three measurement philosophies are related in a hierarchical fashion. Non-intrusive network monitoring by protocol analyzers gives an indication of overall performance and can often isolate problems to the component or section. When monitoring is insufficient, such as during software debugging or systems integration, protocol analyzers also can be used to simulate network components such as front-end processors or terminals. Once sectionalized, BER testers are used to verify and quantify the link dysfunction, and analog measurements determine which tariffed parameter is out of specification should the telephone line be the problem.

The three measurement philosophies working together can help speed the isolation of the problem to a specific component. For example, a high number of time-outs from a

specific terminal cluster (protocol analysis), combined with a high BER and a low BLER in the data link (digital measurement), would narrow the problem to the suspected terminal's data link (modem and channel). A subsequent analog test which showed an out-of-spec impulse noise measurement would not only isolate the problem to the telephone line, but suggest who is responsible for fault determination and even what circuit component is the problem (e.g., switching equipment). This eliminates any question of which vendor to call.

Thus, combined protocol, digital, and analog tests can be used synergistically to restore the network quickly and efficiently. The next sections describe in more detail how the three measurement areas can be used to increase your network availability.

Protocol Analysis

The visibility of what happens to information once it enters the datacom network is quite limited. You know what you actually typed or what your program says, but you don't know what the CPU or terminal actually sent. In most cases, the transmitted data stream out will not only be the information you entered, but will also include some synchronization, address, control and error checking information to allow error free delivery of your data. Similarly, replies from the destination are also surrounded by this same "overhead".

A protocol analyzer can give you visibility of these entire messages and replies. Attached at the physical network interface connector, a protocol analyzer in its passive mode provides a window to watch the actual character streams as they pass by. If it has simulate capability, the analyzer can also produce data streams that simulate a network component.

Protocol testing is primarily used in the following applications:

- Troubleshooting
- System integration/installation
- Software development
- Network performance optimization

Using a protocol analyzer for troubleshooting will allow you to look for errors in the entire message as it relates to your network protocol. This includes verifying the integrity and timing of the overhead characters as well as the data itself. Messages can be displayed in various formats, from the high level code set to be used in the network (such as ASCII or EBCDIC) to a binary presentation. Protocol analyzers will capture some portion of the

data stream at the networks operating speed for slower, detailed analysis later. You can also verify hand-shake status and timing with protocol analyzers.

When you have problems connecting new Data Terminal Equipment (DTE) to an existing network, a protocol analyzer can help point out protocol inconsistencies between them. With simulate (interactive) capability you can make your protocol analyzer imitate the DTE to the network (or the network to the DTE) to verify that correct messages are being sent and received by each.

Developing network software can be a problem without a network to test it on. Again, the protocol analyzer's interactive capability can be used to simulate the network to provide an efficient, economical way to debug new software before connecting to the actual operating network with its attendant risks.

Protocol analyzers can make measurements from which network performance statistics can be derived. Line utilization vs. time of day, average poll/response times between devices, and other similar statistical kinds of information can be extremely useful to network designers trying to optimize network throughput or cost effectiveness.

Digital Measurements

Data error analyzers are used to test the quality of both the modem and the transmission facility. They provide information about the modem and transmission line but no information about the DTE which they replace.

PROTOCOL ANALYZER	1640B	4955A
Maximum Bit Rates:		
Asynchronous	9.6 kbps	56 kbps
Synchronous	19.2 kbps	72 kbps
Programmable	menu	BASIC (opt)
Mass Storage	HP-IB	2 tapes
Monitor Buffer	2k (bytes)	128k (words)
Simulate Buffer	1k (chars)	1k (chars)
Triggers	1	85
Counters	1	5
Timers	1	5
Interface Lead Control	manual	programmable
HP-IB	optional	STD
Keyboard	hex	ASCII

Figure 2

The overall quality of the link is indicated by its BER. A good link will have an error rate better than 1×10^{-5} errors per bit. This measurement will include the effect of both transmission line impairments and the modem's ability to overcome them. Modems vary widely in their sensitivity to line impairments. Low speed (less than 300 bps) and adaptively equalized modems are less sensitive than high speed (more than 4800 bps) and nonadaptively equalized modems.

Since data communications systems transmit data and control information in blocks, these instruments also measure BLER and Percent Error Free Seconds (%EFS). BER, BLER and %EFS can be used together to examine the statistics of the error mechanism. If the BER and BLER or %EFS are both high, the impairment is random and probably due to noise. If the BER is high but the BLER or %EFS is low, the impairment is more sporadic. This happens when lines are switched, synchronization is temporarily lost or impulse noise is too high.

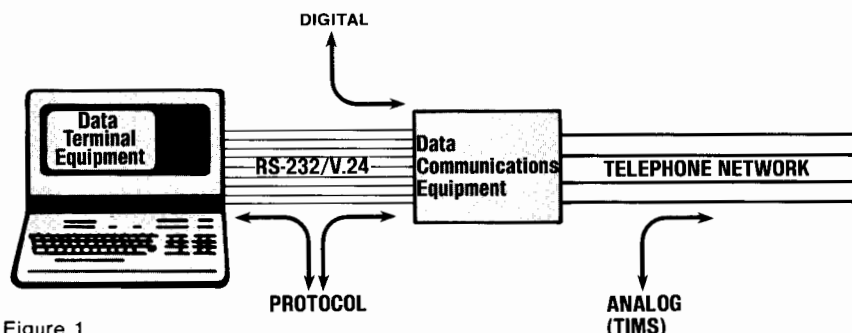

Figure 1

Error rates are qualitative checks of the data communications system which can be made in a few minutes. If the system is bad, diagnostic measurements are provided to help isolate the problem. Dropouts, clock slips, error skew, jitter, and total peak distortion indicate some of the problems that can occur on a link. These measurements are made simultaneously with the error rate measurements and can be printed out in automatic, unattended mode if desired.

Catastrophic failures can usually be found with self-tests and loop-back switches built into the modem. Data error analyzers can find failures that are not illuminated by internal self-tests.

Modem dynamics are another source of data transmission problems. Modern modems have automatic equalization circuits to compensate for telephone line distortions. It is important to let the equalization process settle, particularly with switched carrier modems, so data is not transmitted too soon.

Measurements which verify modem dynamics are RTS-CTS delay, and modem start up tests, such as *ping-pong*.

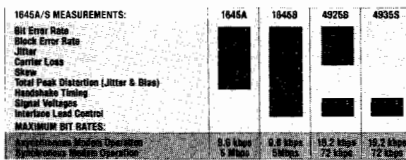

Figure 3

Data Communications and the Telephone Line

The telephone network, because it exists between virtually every location where data travels, provides the basic mechanism for carrying data long distances. Most commonly used is the standard dial-up network which is used for voice communications with the addition of modems. This generally carries low speed data (2400 bps or less), but in some cases can carry 4800 bps or even 9600 bps.

Modems are widely used for medium speed data (up to 9600 bps) on leased telephone lines, which are permanent connections. These lines can be specially selected and conditioned to carry data more effectively.

For high speed data, leased telephone lines are used. In many cases, this data can be carried direct digitally without the need for modems. Bell's DDS service, for example, carries 56 kbps data this way.

Analog Impairments Affect Performance

Analog impairments on the telephone line can significantly affect the efficiency of data communications. What the user notices is a slow down in transmission (because of frequent retransmission of blocks of data), garbled data or no data at all. These effects are a result of the line impairments so distorting the modem signal that the receiving modem

	Basic Testing					Conditioned Circuit Testing			Additional Testing for Complete Troubleshooting	Remote Automatic Testing							
	Up to 2400 bps		Up to 9600 bps and DDS			C & D Conditioning—BELL M1020 & M1040 Conditioning—CCITT											
	Loss Continuity	Notice Loss vs. Freq.	Signal/Noise Ratio	Impulse Noise	Impulse Noise	W/Retard	P/AR	Envelope or Group Delay	Attenuation Distortion	N/D or Intermodulation Distortion	Phase Jitter	Amplitude Jitter	Hits Dropouts	Return Loss	CCITT Constaint	HP-IB SYSTEMS	Master/Slave
BELL Recommendations	3551A																
	4935A																
	4945A																
	3771B																
CCITT Recommendations	3552A																
	4936A																
	3770B																
	3771A																

Figure 4

cannot make correct decisions. Data bits and blocks are received in error.

The various modem types are susceptible to each impairment in differing degrees. Low speed modems generally use robust modulation schemes and are mostly affected by problems of *continuity*, *loss*, *signal-to-noise ratio*, and *impulse noise*.

As modem speeds increase, the modulation scheme becomes more complex and so they are more susceptible to other impairments. Two approaches are taken to minimize these effects. One is to select and condition leased telephone lines to eliminate significant impairments. The impairments of concern are *bandwidth reduction*, *envelope (or Group) delay distortion*, *non-linear (Inter-modulation) distortion*, *return loss*, *phase jitter*, *hits*, and *dropouts*.

The other approach can address a limited number of these with varying degrees of success. Automatically adjusting equalization is built into the modem itself. This can take care of significant *signal/noise ratio reduction*, *bandwidth reduction*, and *envelope (or Group) delay distortion*, as well as some *phase jitter* and *return loss* problems. There is no significant protection against the other impairments and cases of severe or rapidly changing *envelope (or Group) delay distortion* or *bandwidth reduction* may not be adequately compensated for either.

Direct digital transmission is significantly more robust and basically affected by prob-

lems of *continuity*, *signal-to-noise ratio*, *impulse noise* and to some degree *jitter*.

Increasing Network Availability

Whether installing and turning up a data communications network or going through the process of troubleshooting and fault isolation, analog transmission testing will greatly increase network availability.

Installation time and cost can be significantly reduced by prudent use of analog transmission testing in the initial phases. Confidence that the telephone network will pass data saves time-consuming return visits from data line installation personnel to find out why the modems and line will not all work together. A range of test sets is available to permit verification of line parameters for most modem and line type configurations. (See Figure 4 for an aid in selection of the one most appropriate for your application).

Troubleshooting and fault isolation time and cost for a data communications network can be greatly reduced by use of analog transmission testing. Clearly identifying the telephone line impairment, using the recommended Bell and CCITT measurement techniques, leads to immediate identification of how the fix should be approached and who is responsible for the restoration of the network. (See Figure 2 for an aid in selection of the test set most appropriate for your application).



DATA COMMUNICATIONS TEST EQUIPMENT

Telephone Line Analyzer; Data Line Analyzer Models 3770B, 3771A, 3771B

3770B

- Compatible with CCITT Recommendation 0.81
- Makes all the maintenance measurements listed in CCITT Recommendation M.1060
- Optional slaving facilities

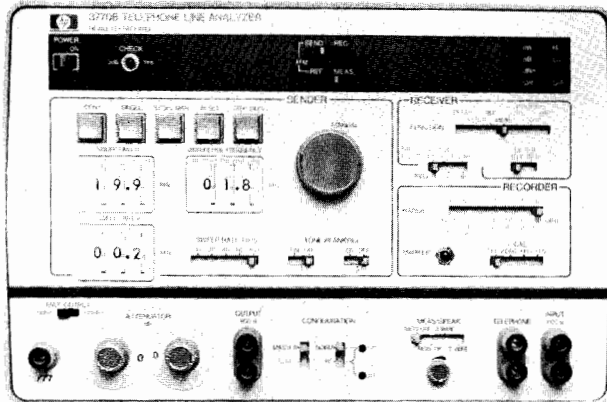

3770B

3771A/B

- CCITT and Bell versions
- Simultaneous measurement of transients
- HP-IB option
- Optional printer output

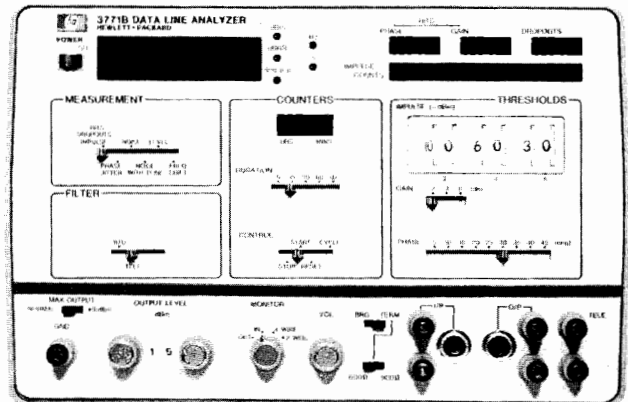

3771B



3770B Telephone Line Analyzer

The 3770B is designed for audio data line characterization to CCITT standards. The 3770B makes, in one combined unit, all of the routine maintenance measurements listed in CCITT Recommendation M.1060 for high speed data lines.

The 3770B measures group delay, attenuation distortion, and absolute level in the frequency range 200 Hz to 20 kHz. It has automatic ranging, zeroing, and synchronization, with simultaneous LED read-out of measurement result and frequency. The sender and receiver are combined in a single, rugged, portable unit.

The 3770B also measures weighted noise, noise-with-tone and impulse noise. A crosstalk measurement is available as an option. Further, an optional slave facility for group delay and attenuation distortion measurements allows the measurement results for both directions of transmission on a 4-wire circuit to be displayed at one end of the circuit. The measurements in both directions can be controlled from one end of the circuit, leaving the slave unit unattended.

The 3770B has X-Y recorder outputs to enable a permanent swept record of the measurements to be made. A suitable portable X-Y recorder can be supplied as an option. Pre-printed graph paper showing CCITT limits for group delay and attenuation distortion measurements can also be supplied.

The instrument also has a built-in telephone facility to allow voice communication in a 2- or 4-wire mode over the line or lines under test. An integral loudspeaker allows the operator to monitor either the receiver input or sender output.

3770B Telephone Analyzer

3771A/B Data Line Analyzer

The 3771A and 3771B Data Line Analyzers have been designed for making installation and troubleshooting measurements on telephone lines used for carrying high-speed data. Two versions are available—the 3771A is compatible with CCITT standards, the 3771B with Bell Publication 41009 (May 1975).

The 3771A is a companion instrument to the HP 3770B Telephone Line Analyzer. When used with the 3771A, it provides a complete portable easy-to-use CCITT data line testing facility. Routine data line maintenance measurements can be performed using the 3770B, and troubleshooting measurements using the 3771A. The 3771B can be used with the HP 4943A/4A Transmission Impairment Measuring Set for complete data line characterization and testing where Bell measurement standards are required.

The 3771A/B measures two basic types of impairment affecting data lines—steady state and transient.

The steady state parameters are: Level, Phase Jitter, Weighted Noise, Noise-with-Tone and Frequency Shift.

The transients measured are: 3-Level Impulse Noise, Phase Hits, Gain Hits and Dropouts.

Transient parameters are normally measured over 15-minute intervals and by measuring all of them simultaneously, the 3771A/B saves considerable operator time. Also, any comparison of results is statistically valid.

The 3771A/B can be used as a stand alone test instrument or as part of an automatic test system. Optional features include printer output for recording the results of unattended long-term transient measurements, and dc loopholding for sender output and receiver input. In-lid operating instructions are provided for the 3771A/B, in addition to the normal detailed operating booklet.

3771A Data Line Analyzer—CCITT

3771B Data Line Analyzer—North America

DATA COMMUNICATIONS TEST EQUIPMENT

15 Hz to 50 kHz Selective Voltmeter

Model 3581C



- Voice grade testing
- Wideband data circuit testing
- Single frequency interference
- Spectrum analysis



Description

The 3581C Selective Voltmeter has found wide application in testing special service circuits in both inside and outside plant maintenance. The 3581C is used to do spectrum analysis, measure non-linear distortion (harmonic distortion) and to locate and measure unwanted spurious and induced tones. The unit can be operated from ac line or from optional internal batteries.

Specifications

Frequency range: 15 Hz to 50 kHz.

Display: 5 digit LED readout. Resolution: 1 Hz. Accuracy: ± 3.5 Hz.

Typical stability: ± 10 Hz/hr. after 1 hour. ± 5 Hz/ $^{\circ}$ C.

Automatic frequency control (AFC), hold-in range: ± 800 Hz.

Pull-in range: $> 5 \times$ bandwidth for 3 Hz to 100 Hz bandwidth; > 800 Hz for 300 Hz bandwidth for full-scale signal.

Lock frequency: center of passband ± 1 Hz.

Amplitude

Instrument Range

Linear: 30 V to 100 nV full scale.

Log: +30 dBm or dBV to -150 dBm or dBV.

Amplitude Accuracy*

	Log	Linear
15 Hz-50 kHz, frequency response	± 0.4 dB	$\pm 4\%$
Switching between bandwidths	± 0.5 dB	$\pm 5\%$
Amplitude display	± 2 dB	$\pm 2\%$
Input attenuator	± 0.3 dB	$\pm 3\%$
Amplitude reference level, Most sensitive range	± 1 dB	$\pm 10\%$
All other ranges	± 1 dB	$\pm 3\%$

Dynamic range: > 80 dB.

Noise sidebands: greater than 70 dB below CW signal. 10 bandwidths away from signal.

IF feedthrough: input level > 10 V: -60 dB; input level < 10 V: -70 dB.

Spurious responses: > 80 dB below input reference level.

Sweep

Scan width: 50 Hz to 50 kHz. These scans can be adjusted to cover a group of frequencies within the overall instrument range.

Sweep error light: this LED indicates a sweep that is too fast to capture full response.

*Note: these specifications cover the full temperature frequency and amplitude range, and represent worst case. Accuracy is significantly better for measurements not at the extremes.

External trigger: a short to ground stops normal sweep. Opening the short then enables a sweep.

Input

Unbalanced (UNBAL)

Impedance: 1 M Ω /40 pF.

Balanced/Bridged (BRDG)

Impedance: 10 k Ω .

Frequency response: 40 Hz-20 kHz, ± 0.5 dBm for signals < 20 dBm.

Balanced/Terminated (TERM)

Impedance: 600 Ω /900 Ω balanced.

Frequency response: same as balanced/bridging.

Input connector: accepts WECO 310 plug.

Output Characteristics

Tracking generator output (also known as BFO or tracking oscillator output). Switchable on rear panel to restored output (3581C acts as a narrow band amplifier).

Range: 0 to 2 V rms.

Frequency response: $\pm 3\%$ 15 Hz to 50 kHz.

LO output: 100 mV signal from 1 MHz to 1.5 MHz as input is tuned from 0 to 50 kHz.

Output connector: WECO 310, for connection to tracking generator output or restored output. In addition to monitoring restored output with headphones, an internal speaker also provides an audio indication of signal content.

Restored output: acts as a narrow band amplifier.

X-Y recorder analog outputs: 0 to +5V $\pm 2.5\%$.

General

Operating temperature range: 0 $^{\circ}$ C to 55 $^{\circ}$ C.

Humidity: 95% relative, maximum at 40 $^{\circ}$ C.

Power requirements: 100 V, 120 V, 220 V, 240 V +5% -10%, 10 VA typical, 48 Hz to 440 Hz.

Size: 412.8 mm H x 203.2 mm W x 285.8 mm D (16 $\frac{1}{4}$ " x 8" x 11 $\frac{1}{4}$ ").

Weight: 11.5 kg (23 lb); Option 001, 13.5 kg (30 lb).

Accessory available: 7035B Option 20, X-Y recorder.

Option 001: rechargeable battery: used to make floating measurements; 12 hours to fully charge. Also includes front panel dust cover.

Ordering Information

3581C Selective Voltmeter

Opt 001: Battery Pack, dust cover

Opt 003: Rack Mount

7035B Opt 020: X-Y Recorder

DATA COMMUNICATIONS TEST EQUIPMENT

Transmission Impairment Measuring Set (TIMS)

Model 4945A

- Compatible with North American standards
- Complete testing of:
 - Voice grade data channels
 - Program channels
 - High speed digital channels
- 110 kHz bandwidth
- Portable package for field use
- Versatile I/O for systems use
- Master/Slave capability for end-to-end testing
- Automatic gain slope measurement
- Programmable sweep

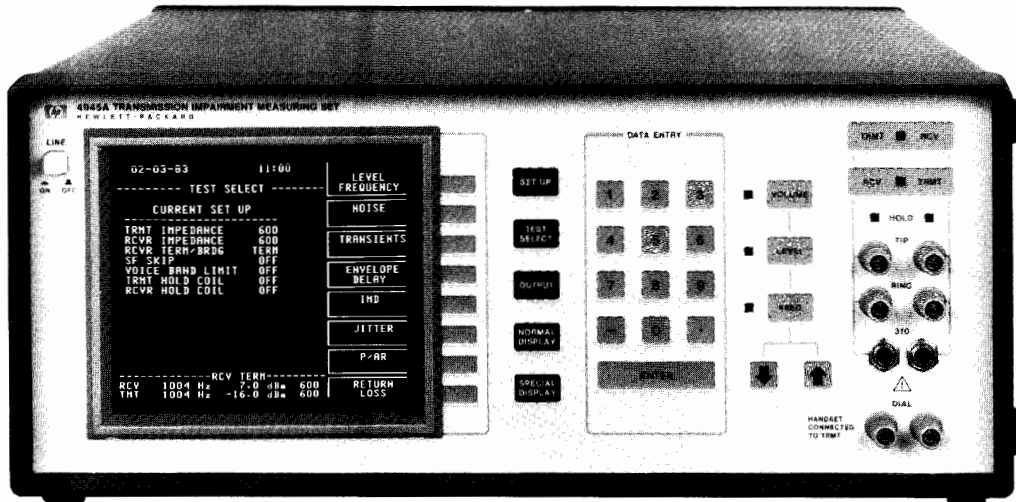

4945A

RS-232



4945A Product Description

The HP 4945A Transmission Impairment Measuring Set provides the complete set of measurements needed to quickly isolate faults and qualify circuits for voice, data or broadcast transmission up to 110 kHz. All measurements are compatible with current Bell standards including the ability to test local distribution loops for Dataphone Digital Service (DDS) to 56 kbps.

Softkeys Guide the User

All set-up selections, measurement selections and results are presented on the CRT display. Softkeys are the key to making the HP 4945A extremely flexible while maintaining ease of operation. All appropriate choices for a particular measurement or configuration are present, thus eliminating guesswork or nonsense configurations. Through softkeys, you are never more than two key presses away from a parameter change.

A Convenient Display

The CRT allows you to see more information than conventional segmented displays. All of the set-up conditions are presented in a logical, easy-to-understand format. The lower three status lines on the display always contain the important set-up information as well as the current level and frequency of both the transmitter and receiver. Some measurements, such as JITTER, have the "measure all" capability which allows simultaneous display of both amplitude and phase jitter in all three frequency bands (4-20 Hz, 20-300 Hz, 4-300 Hz). And don't worry about the CRT in the field environment. HP's experience and rigid testing standards assure you of a reliable product for field use.

Complete Measurement Capability

The HP 4945A offers you all the measurements needed to install, troubleshoot, and maintain both voice and data circuits. These measurements are designed in accordance with Bell System Technical Reference 41009. The list includes:

- | | |
|-------------------------------|------------------------------|
| LOSS | 3 LEVEL IMPULSE NOISE |
| ATTENUATION DISTORTION | GAIN HITS |
| GAIN-SLOPE | PHASE HITS |
| MESSAGE CIRCUIT NOISE | DROPOUTS |

- | | |
|-----------------------------------|--------------------------------------|
| NOTCHED NOISE | ENVELOPE DELAY DISTORTION |
| SIGNAL-TO-NOISE RATIO | PEAK-TO-AVERAGE RATIO (P/AR) |
| NOISE-TO-GROUND | 2-WIRE RETURN LOSS |
| AMPLITUDE JITTER | 4-WIRE RETURN LOSS |
| PHASE JITTER | SINGLE FREQUENCY INTERFERENCE |
| INTERMODULATION DISTORTION | |

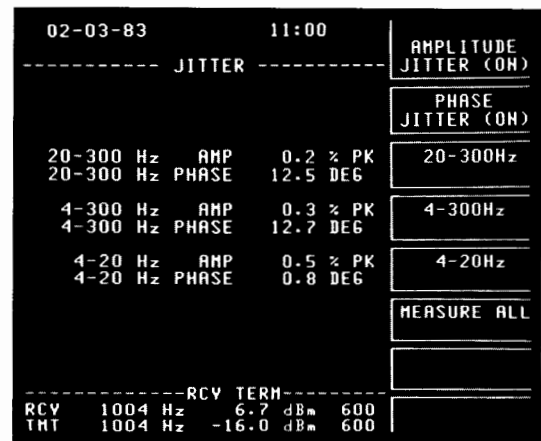

The CRT display provides more area for displaying useful data. Here, both phase and amplitude jitter in all three bands are simultaneously displayed along with the current receive and transmit status.

Master/Slave Capability

Master/Slave saves time and money by allowing you to control the remote (Slave) TIMS from the local (Master) TIMS. This HP-pioneered and patented technique allows the Master unit to completely control and collect data from the remote Slave unit over the lines under test. Master/Slave greatly reduces the time, coordination, and highly-skilled manpower needed for performing end-to-end tests. The Master/Slave technique used on the HP 4945A is also backward-compatible with the HP 4943A and HP 4944A.

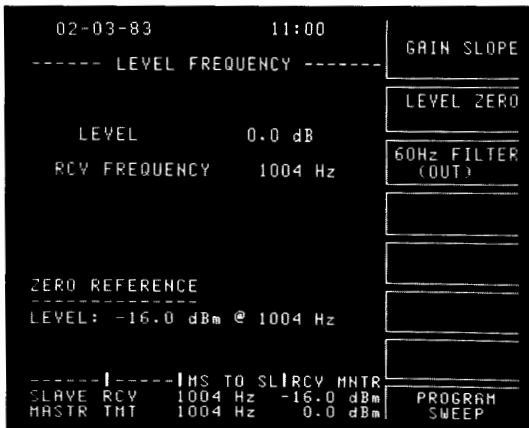

Master/Slave measurement results are displayed just like manual end-to-end results. The status lines indicate the direction of test (Master to Slave) and the current status of the Slave's receiver and Master's transmitter.

Systems Capability

The HP 4945A can be controlled by a computer or controller over three different interfaces. For the larger systems, HP-IB provides the speed and versatility needed to tie together many test instruments in a customized system. For those faced with the problem of the HP 4945A being distant from the controller, RS-232C provides a low-cost solution for control. With the addition of inexpensive modems, a 4945A can be controlled over dial or leased lines. If portable data collection is a must, HP-IL provides a low-cost portable solution with a handheld calculator, such as the HP-41C, acting as the controller.

In addition, the HP 4945A can output measurement results directly to a printer without the need for a controller. This now gives you hardcopy results from any HP-IB, RS-232C, or HP-IL printer.

Complete Self-Check and Calibration

Every time the HP 4945A is powered on, it executes a self-check which assures you that all the major blocks are functioning properly. There is also a built-in self-calibration mode. No longer is it necessary to send the instrument in for periodic calibration. With the simple press of a softkey, the HP 4945A will calibrate itself, thus avoiding costly downtime and assuring you that the HP 4945A is operating at its peak performance. In addition, built-in self diagnostics quickly isolate and identify any problems thus reducing repair time and consequently downtime.

Specifications

For detailed specifications ask your local HP Sales Office for a 4945A TMS Data Brochure.

General

Impedances: 135Ω, 600Ω, 900Ω, 1200Ω.

Power: 115/230 V AC + 11%–22%, 48 to 63 Hz, 150 W MAX

Dimensions: 18.4 cm H x 45.1 cm w x 48.9 cm D (7.25" x 17.75" x 19.25")

Weight: 15 kg (33 lb).

Interfaces Available: HP-IB, RS-232C, HP-IL.

Level and Frequency

Transmitter

Frequency range: 20 Hz to 110 kHz.

Output level: –60 dBm to +13 dBm; 600Ω, 900Ω, 1200Ω.
–60 dBm to +5 dBm 135Ω.

Receiver

Range: –60 dBm to +13 dBm

Noise Measurements

Transmitter: 1004 Hz fixed or quiet termination.

Receiver Range

Message circuit noise: 10 to 90 dBm

Noise-with-tone: 10 to 90 dBm

Noise-to-ground: 40 to 130 dBm

Signal-to-noise ratio: 10 to 45 dB

Weighting filters: C-message, 3 kHz Flat, Program, 15 kHz Flat, 50 kbit

Notch filter: 60 dB rejection from 995 to 1025 Hz.

Peak to Average Ratio

Transmitter

Signal spectrum: 16 Frequency Complex Waveform.

Range: –40 to 0 dBm.

Receiver

Level range: –40 to 0 dBm.

P/AR range: 0 to 120 P/AR Units.

Jitter

Transmitter

See Noise Measurements.

Receiver

Amplitude jitter: 0 to 40% peak to peak

Phase jitter: 0 to 40 degrees peak to peak

Bandwidths: 4 to 20 Hz
20 to 300 Hz
4 to 300 Hz

Transients

Transmitter

See Noise Measurements or Quiet Termination.

Receiver

General: Count rate: 7, 8, 100 counts per

Count range: 0 to 9,999.

Timer: 1 to 9,999 minutes or continuous.

Phase hits: thresholds: 5° to 45° in 5° steps.

Gain hits threshold: 2 to 10 dB in 1 dB steps.

Drop outs: threshold 12 dB.

Impulse Noise Range

Low: 30 to 110 dBm.

Mid: 2, 3, 4, or 6 dB above Low.

High: 2, 3, 4, or 6 dB above Mid.

Envelope Delay

Transmitter

Level range: –40 to 10 dBm

Modulation: 83½ Hz

Receiver

Measurement range: –3000 to 9000 microseconds.

Return Loss

Modes: ERL, SRL-High, SRL-Low, Sine Wave

2-Wire:

Range: 0 to 40 dB

Internal Hybrid 600Ω, 900Ω, in series with 2.16μ F Capacitor, or External.

4-Wire:

Range: 0 to 50 dB.

Trans Hybrid Loss Compensation: –10 to 30 dB.

Ordering Information

4945A TMS

Options

101: adds 18162A HPIB Module

102: adds 18163A RS-232C Module

103: adds 18165A HP-IL Module

104: adds 18169A 19" Rack Mount

105: adds 18170A Soft Vinyl Carrying Case

Accessories

18162A HP-IB Module

18163A RS-232C Module

18165A HP-IL Module

18169A 19" Rack Mount

18170A Soft Vinyl Carrying Case

9211-2650 Hard Transit Case

*The Non-Linear Distortion Technique is licensed under Hekimian Laboratories, Inc., USA Patent No. 3862380.

DATA COMMUNICATIONS TEST EQUIPMENT

Transmission Impairment Measuring Sets (TIMS)/Bit Error Rate Test Set (BERT)

Models 4935A/4936A and 4925A

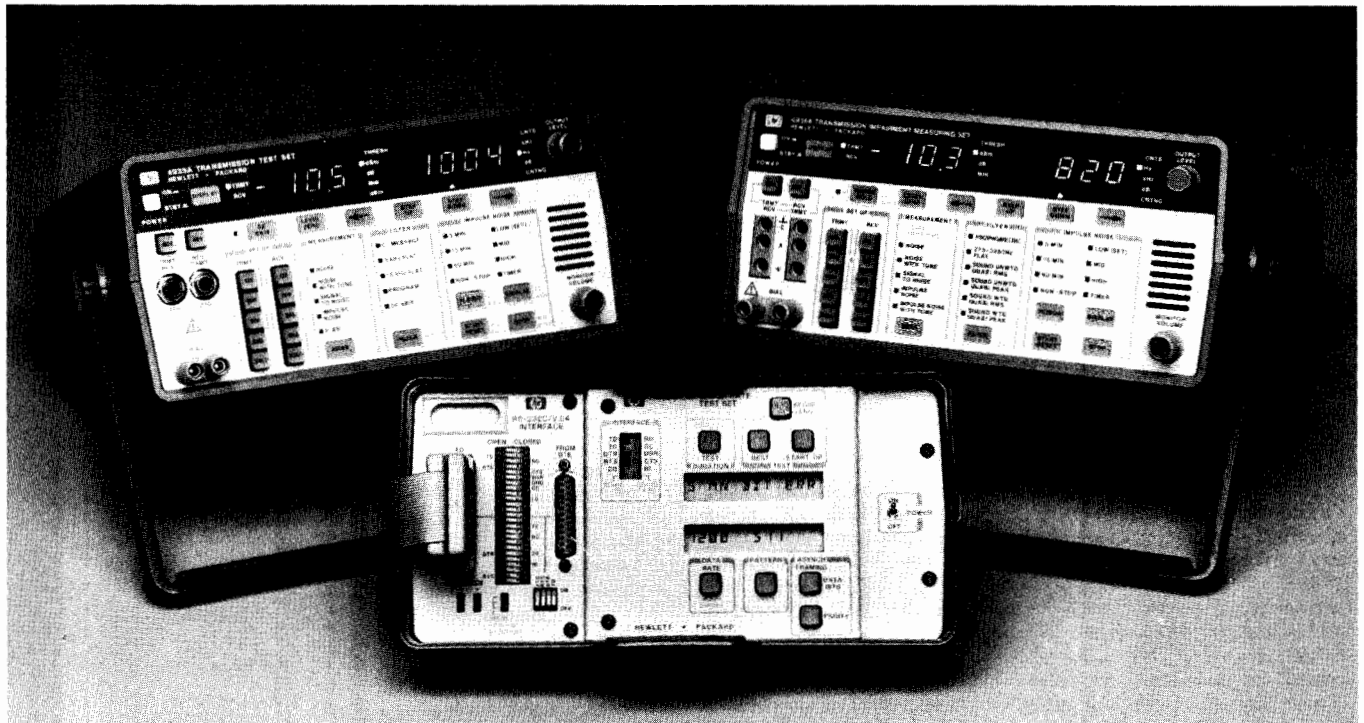

Product Description

Qualify Circuits for Voice, Data or Program

The Hewlett-Packard 4935A/4936A Transmission Impairment Measuring Sets provide the basic analog tests to isolate faults and to qualify circuits for voice, data or broadcast transmission at frequencies up to 110 kHz. The 4935A is compatible with Bell standards and the 4936A is CCITT compatible. Both of these test sets provide measurements of level versus frequency, noise with various selectable filters, Signal-to-Noise Ratio, Noise with Tone, Three-level Impulse Noise and 4-wire single frequency return loss. The 4935A performs the required tests to qualify the local loop for Digital Dataphone Service up to 56 kbps. The Peak-to-Average-Ratio (P/AR) measurement option on the 4935A gives system users a powerful yet simple measure of the combined factors which effect the overall data transmission quality of the line. The P/AR measurement was developed by Bell Laboratories and is useful as a benchmark of a line's data transmission quality.

Telephone companies, PABX and other telecommunications equipment service people will find the 4935A/4936A has the analog testing capability they need. Both instruments include standard dial and hold capabilities, independent transmit and receive impedances, level zero function, SF skip and complete unit annunciation.

Portable for Field Use

The 4935A/4936A in its rugged polycarbonate case weighs only 14 pounds with batteries. This lightweight instrument is ideal for field applications.

Digital Testing Quickly Isolates Problems

The 4925A Bit Error Rate Test Set sits on the digital interface (see network diagram) and measures the integrity of the data link to properly transmit and receive error free data. The 4925A was designed to isolate and identify problems encountered in a data communications environment up to 72 kbps. Digital testing allows you to perform bit error tests, data throughput analysis and to test terminals, printers and statistical multiplexers for proper operation.

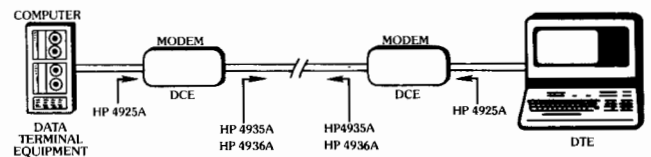

More than a BERT

The HP 4925A is more than just a bit error rate test set. In addition to the standard bit and block error tests, the 4925A measures errored seconds, percent error-free seconds, timing delay, and parity errors. Increased flexibility is afforded by providing you with the ability to verify various elements of Level 1 protocol in the form of a complete breakout box. You can manipulate and monitor individual signal lines on the RS-232C/V.24 interface or crosspatch any line from the DCE side of the interface to the DTE side of the interface.

In addition, the 4925A adds to its arsenal the ability to frame data for testing character-oriented systems. The 4925A also transmits the FOX message to terminals and printers. Three separate start-up tests enable dynamic testing of modems. This makes the unit extremely useful in isolating faults related to the following modem functions: automatic equalization, receive carrier recovery, receive clock synchronization and initial recovery of received data. The start-up tests consist of an end-to-end half-duplex ping-pong test, a local modem loopback test primarily designed to test multi-drop systems and a test specifically designed to use the remote testing capabilities of the Bell 208B modem.

Intended primarily for field service installation and maintenance, the 4925A weighs only three pounds with batteries. When ordered as option 001, the 4925A will fit in place of the cover of either the 4935A or 4936A. Option 001 deletes the small vinyl carrying case.

Easy-to-Use Instruments Reduce Testing Time

Both the 4935A/4936A and the 4925A are easy to use, allowing reduced training time, fewer operator errors and reduced testing times. The HP 4935A/4936A guides you through the measurements by activating only the proper keys for each selection. Each selected function is indicated on its own LED and there is a beep when a key is pressed. Complete annunciation displays the selected measurement, proper units for each measurement and error messages if there is a problem with either the measurement or the instrument.

Intelligent microcomputer control and full alphanumeric display capabilities simplify operation of the 4925A. At power up, it automatically sets up a typical testing configuration of a 5-minute bit error count, block error count and errored second count at 1200 bps with a 511 PRBS. If the test set-up needs to be modified, just press the appropriate button and scroll through the menu until the proper configuration is set.

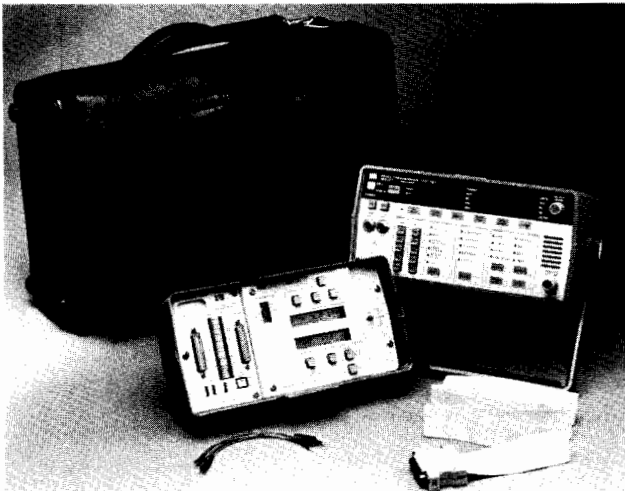

The HP 4935S includes the HP 4925A option 001, the 4935A and a large carrying case.

4935S Data Transmission Test Set Options

- 001: adds rechargeable battery pack to the HP 4935A
- 002: adds P/AR measurement in place of noise-to-ground in the HP 4935A
- 003: adds both battery pack and P/AR to the HP 4935A, deletes noise-to-ground
- 910: adds extra HP 4935A and HP 4925A Operating and Service Manuals

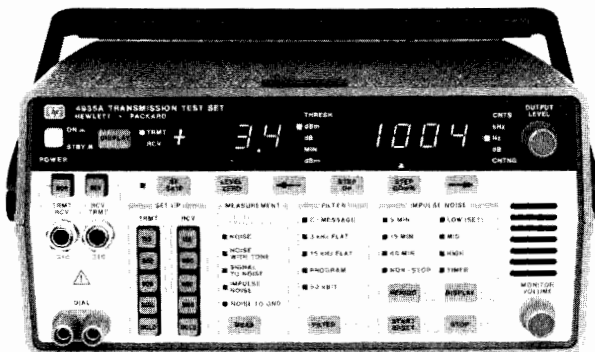

4935A Transmission Impairment Measuring Set

Options

- 001: adds rechargeable battery pack
- 002: adds P/AR measurement in place of noise-to-ground

003: adds both battery pack and P/AR, deletes noise-to-ground

910: adds extra HP 4935A Operating and Service Manual



4936A Transmission Impairment Measuring Set

- 001: includes 820 Hz tone with rechargeable battery pack
- 002: 1020 Hz tone
- 003: includes 1020 Hz tone with rechargeable battery pack
- 910: adds extra HP 4936A Operating and Service Manual

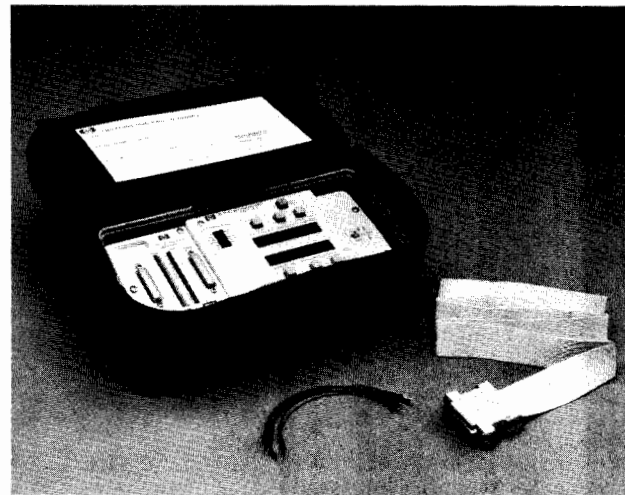

4925A Bit Error Rate Test Set

Options

- 001: deletes small vinyl carrying case HP 18172A (for connection to the HP 4935A)
- 910: adds extra HP 4925A Operating and Service Manual

Accessories

- 18132A 19 inch rack-mount adapter for the HP 4935A
- 18134A Soft vinyl carrying case for the HP 4925A or HP 4935S
- 18172A Soft vinyl carrying case for the HP 4925A
- 15513A 36-inch test cord with 310 male connector at both ends
- 18161A Ladder Bracket



DATA COMMUNICATIONS TEST EQUIPMENT

Transmission Impairment Measuring Set (TIMS)/Bit Error Rate Test Sets (BERT) Models 4935A/4936A and 4925A (cont.)

4925A Specifications

Data rates: 75, 110, 134.5, 150, 200, 300, 600, 1200, 1800, 2400, 3600, 4800, 7200, 9600, 14400, 19200 bps for asynchronous systems or externally timed synchronous. Up to 72 kbps for synchronous systems.

Patterns: 63, 511 or 2047 bit pseudo random binary sequence, FOX message.

Bit error testing: simultaneous detection of bit errors, block errors, errored seconds and percent error-free seconds.

Parity error analysis: characters analyzed for odd or even parity errors.

FOX message transmission: use a 5 bit baudot code, 6 bit EBCD code, 7 bit ASCII code or 8 bit EBCDIC code.

Character Oriented Network Testing

Data levels: 5, 6, 7 or 8 bits per character.

Parity: odd, even or none.

Detection and Annunciation of Dropouts and Clock Slips

RTS-CTS Delay Time

Resolution: 1 msec.

Accuracy: $\pm 4\%$ of reading.

Maximum reading: 999 msec.

Start-up testing: end-to-end test, loopback test, Bell 208B modem test.

Interface/breakout box (RS-232C/V.24): hard-wired activity indicators for TD, RD, TC, RC, DTR, DSR, RTS, CTS, CD, RI; one nondedicated mark/space tristate activity monitor; individual line switches.

Inject Error Function

Power: six 9 volt alkaline transistor batteries; battery life exceeds 50 hours of operation.

Weight: 1.5 kg (3 pounds) with batteries.

Specifications Level and Frequency

4935A

Transmitter

Frequency range: 20 Hz to 110 kHz.

Resolution: ± 1 Hz to 100 kHz.
 ± 10 Hz, 110 kHz.

Level range: -40 to +13 dBm.

Level resolution: 0.1 dB.

4936A

Transmitter

Frequency range: 20 Hz to 110 kHz.

Resolution: ± 1 Hz to 100 kHz.
 ± 10 Hz, 110 kHz.

Level range: -40 to +13 dBm.

Level resolution: 0.1 dB.

4935A

Stored frequencies: 404 Hz, 1004 Hz, 2804 Hz, 2713 Hz.

SF skip skips band: 2600 Hz ± 150 Hz.

Receiver

Frequency range: 20 Hz to 110 kHz.

Resolution: ± 1 Hz to 10 kHz.
 ± 10 Hz, to 110 kHz.

Level range: -60 to +13 dBm.

Level accuracy: from -40 to +13 dBm.

20-50 Hz ± 1.0 dB.

50-200 Hz ± 0.5 dB.

200 Hz-15 kHz ± 0.2 dB.

15 kHz-85 kHz 0.5 dB.

Level resolution: 0.1 dB.

4936A

Stored frequencies: 300 Hz, 820 Hz*, 2000 Hz, 3000 Hz.

Tone blanking: SF skip skips 2280 Hz ± 150 Hz.

Receiver

Frequency range: 20 Hz to 110 kHz.

Resolution: ± 1 Hz, to 10 kHz.
 ± 10 Hz, 110 kHz.

Level range: -70 to +13 dBm.

Level accuracy: from -40 to ± 13 dBm.

20-50 Hz ± 1.0 dB.

50-100 Hz ± 0.5 dB.

100 Hz-4 kHz ± 0.1 dB.

4 kHz-15 kHz ± 0.2 dB.

15 kHz-85 kHz ± 0.5 dB.

*1020 Hz tone and notch is available as an option.

Level resolution: 0.1 dB.

Noise Measurements

4935A

Level Range

Message circuit noise: 0 to 100 dBm.

Noise with tone: 10 to 100 dBm.

Noise to ground: 50 to 130 dBm.

Detector: quasi rms.

Notch filter: 50 dB rejection from 995 to 1025 Hz.

4936A

Level Range

Noise: -90 to +10 dBm.

Noise with tone: -80 to +10 dBm.

Detectors: quasi rms.

Quasi peak - monitored by analog outputs.

Notch filter: 50 dB rejection from 800-855 Hz*.

3 Level Impulse Noise

4935A

Threshold ranges @ 600 Ω

Low

30 to 109 dBm.

Mid

4 dB above Low to 109 dBm.

High

8 dB above Low to 109 dBm.

Range of tone: -40 to +13 dBm.

4936A

Threshold ranges @ 600 Ω

Low

-60 to 16 dBm.

Mid

3 dB above Low to 16 dBm.

High

6 dB above Low to 16 dBm.

Range of tone: -40 to +13 dBm.

Peak to Average Ratio

4935A

Transmitted level range: -40 to 0 dBm.

Received level range: -40 to +3 dBm.

P/AR range: 0 to 120 P/AR units.

Resolution: 1 P/AR unit.

4936A

Not offered

4935A General

Impedance: 135 Ω , 600 Ω , 900 Ω .

Filters: C message

3 kHz flat

15 kHz flat

Program

50 kBit

4936A General

Impedances: 150 Ω , 600 Ω , 900 Ω .

Filters: Psophometric (P. 53)

275-3250 Hz Flat (0.71 impulse noise)

Sound unweighted (J. 16).

Sound weighted (J. 16).

*With option 1020 Hz tone notch is same as 4935A.

- Attenuation distortion
- Loss
- Message circuit noise
- Noise-with-tone
- Noise-to-ground
- Single frequency interference



3551A (North American)

3551A/3552A Description

The HP 3551A/3552A Transmission Test Sets are rugged, portable test sets ideally suited for measurements on voice, program and data circuits up to 50 kbps. The 3551A is designed for use with North American Bell Standards, while the 3552A is designed for the CCITT standards. Both test instruments contain tests capable of measuring tone level, noise or frequency while simultaneously sending tone. Both level and frequency are fully autoranging.

These test sets can measure both 2-wire and 4-wire balanced circuits. The test sets may be powered by either ac line or internal rechargeable batteries and are suited for both inside and outside plant maintenance.

For frequency measurements, a four digit autoranging frequency counter is provided. The readout features 1 Hz resolution from 40 Hz to 10 kHz and 10 Hz resolution from 10 kHz to 60 kHz.

A convenient set of clip-on dial terminals for connecting a lineman's handset are provided. This allows a line connection to be dialed up and then held in an off-hook condition while making either a receive measurement or transmitting a signal on the line.

Noise measurements are made with a quasi rms detector and displayed in dBm on the 3551A and dBm on the 3552A. Display rate is slowed to 2 per second to provide an analog feel of slowly changing noise levels. Both test sets have the capability of measuring noise-with-tone, message with circuit noise, and noise-to-ground. Four switch selectable weighting networks are provided; 3 kHz, 15 kHz Flat and Program for both models plus a C-message with the 3551A and a Psophometric with the 3552A.

3551A & 3552A Specifications

Receiver

Level Measurements

Frequency range: 40 Hz to 60 kHz.

Dynamic range: +15 dBm to -70 dBm.

Resolution: 0.1 dB.

Accuracy: at 25°C ± 10°C, temperature coefficient: ±0.005 dB/°C beyond this range.

INPUT LEVEL (dBm)	FREQUENCY					
	40 Hz	100 Hz	1 kHz	16 kHz	20 kHz	60 kHz
+15	±0.5 dB	±0.1 dB			±.2 dB	±0.3 dB
-30		±0.3 dB				±0.5 dB
-70						

Receiver Accuracy Not Specified Below 500 Hz Or Below -65 dBm When Using 135 Ω Input.

Transmitter 3551A & 3552A

Frequency range: 40 Hz to 60 kHz.

Resolution: 1 Hz (40 Hz to 10 kHz). 10 Hz (10 kHz to 60 kHz).

Level range: +10 dBm to -60 dBm (40 Hz to 60 kHz). +6 dBm to -60 dBm. (1004 Hz fixed for 3551A; 800 Hz fixed for 3552A).

Resolution: 0.1 dB.

Accuracy: at 25°C ± 10°C, temperature coefficient: ±0.005 dB/°C beyond this range.

OUTPUT LEVEL (dBm)	FREQUENCY				
	40 Hz	100 Hz	1 kHz	4 kHz	60 kHz
+10	±0.5 dB		±0.2 dB		±0.5 dB
-30					
-60	±1 dB		±0.3 dB		±1 dB

Transmitter Accuracy Not Specified Below 500 Hz On 135 Ω or 150 Ω Output.

3551A Noise Measurements

Dynamic Range

Message circuit noise: 0 dBm to +85 dBm.

Noise-with-tone: 10 dBm to +85 dBm.

Noise-to-ground: 40 dBm to +125 dBm.

Resolution: 1 dB.

Detector type: quasi rms responding.

3552A Noise Measurements

Dynamic Range

Message circuit noise: -90 dBm to -5 dBm.

Noise-with-tone: -80 dBm to -5 dBm.

Noise-to-ground: -50 dBm to +35 dBm.

Resolution: 1 dB.

Detector type: quasi rms responding.

General

Balanced impedances: 135 Ω, 600 Ω, 900 Ω (3551A).

Balanced impedances: 150 Ω, 600 Ω, 900 Ω (3552A).

Hold circuit: 20 milliamps constant current. <0.2 dB holding loss, resistive fuse protection.

Input/output protection: blocks 300 V dc.

Maximum longitudinal voltage: 200 V rms.

Battery supply: >4 hours continuous operation on internal rechargeable batteries at 25°C. Recharge in 12 hours.

Power requirements: 100 V, 120 V, 220 V, 240 V ± 10%; 48 Hz to 440 Hz; 15 VA.

Temperature range: 0°C to 55°C, operating; -20°C to +65°C, storage.

Size: 133 mm H x 343 mm W x 254 mm D (5.25" x 13.5" x 10").

Weight: Net, 6.6 kg (14.5 lbs.). Shipping 7.3 kg (16 lbs.).

Ordering Information

3551A Transmission Test Set

3552A Transmission Test Set (CCITT)



DATA COMMUNICATIONS TEST EQUIPMENT

Six Simultaneous, Automatic Data Measurements

Models 1645A & 10235A

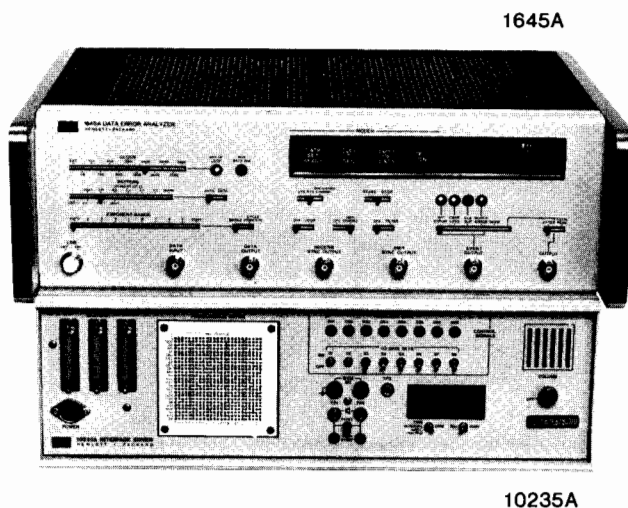

1645A Description

Hewlett-Packard's Model 1645A Data Error Analyzer quickly isolates data communications link problems through six simultaneous measurements. During tests, the 1645A can be left totally unattended because it automatically maintains synchronization even in the presence of dropouts. For added convenience, the 1645A can be equipped with a printer for hard-copy recordings of long tests.

Bit-error and block-error rate tests are autoranged and displayed directly on an LED readout; there is no need to perform any calculation. Additionally, the 1645A measures jitter or total peak distortion (the sum effect of jitter and bias), counts the number of times carrier loss or dropouts occur, measures data error skew and counts the number of clock slips resulting from phase hits or modem synchronization problems.

With all these measurements made during the same test interval, you'll be able to determine more precisely where your problem is.

1645A Specifications

Transmitter and Receiver Bit Rate

Asynchronous modem operation: selectable 75, 150, 200, 300, 600, 1200, 1800, 2400, 3600, 4800, 7200, 9600 bps.

Synchronous modem operation: to 5 Mbps. (Modem supplies transmit and receive clocks.)

Indicators

Out of lock; received data inverted; bit error; carrier loss; clock slip; block error; data set ready (DSR); clear to send (CTS); loss of data; test on.

General

Power: 115 or 230 V ac, 48 to 440 Hz, 150 VA max.

Dimensions: 133 H x 425 W x 286 mm D (5.25" x 16.75" x 11.25").

Weight: net, 8.2 kg (18 lb). Shipping, 10.9 kg (24 lb).

Accessories supplied: one 3 m (10 ft) RS-232C interconnecting cable to connect the 1645A to the modem (HP P/N 01645-61605), one 2.3 m (7.5 ft) 3 wire power cord (HP P/N 8120-1378); one Operating and Service Manual.

10235A Description

The 10235A Interface Cover is designed for troubleshooting problems on the RS-232C interface bus. Common problems such as wrong voltages and excessive turnaround times, which often occur during installation, are easily pinpointed with the measurement capability of the interface cover.

Direct digital readouts of time intervals and transmission signal voltages are easily obtained using the 24 x 25 pin matrix to patch the appropriate lines of the RS-232C interface to the desired measurement. Similarly, logic levels of signals on the RS-232C lines can be monitored using the eight LEDs. Control of individual lines is achieved using any of the eight control switches to apply +5 V or -5 V to the lines. Audio monitoring capability is also provided.

10235A Specifications

Time Interval

Range: 999 ms full scale.

Resolution: 1 ms.

Accuracy: $\pm 2\%$ of measured interval ± 1 count.

Start-stop: TP1 & TP2 input, LED indicates event start at TP1 or TP2.

DC Digital Voltmeter

Ranges: 19.99 V, 199.9 V full scale.

Accuracy: $\pm 1\%$ of reading, ± 1 count.

Indicator and Control Functions

Indicators: eight light emitting diodes.

Audio: built-in loudspeaker and volume control.

Control switches: eight switches supply control signals.

General

Power requirements: +15 V to 25 V and -15 V to -25 V supplied by the 1645A.

Dimensions: 132 H x 399 W x 48 mm D (5.25" x 15.75" x 1.9").

Weight: net, 1.8 kg (4 lb). Shipping, 3.2 kg (7 lb).

Accessories supplied: one 46 cm (18") RS-232C interconnecting cable—connects 10235A to 1645A (HP P/N 10235-61606); one accessory pouch—attaches to side of 1645A (HP P/N 1540-0385); one power cable (HP P/N 10235-61602); one Operating Note.

Ordering Information

1645A Data Error Analyzer

Opt 908: Includes rack mounting kit

Opt 910: Additional set of manuals

10235A Interface Cover

1645S Data Transmission Test Set*

Opt 910: Additional set of manuals

Interfaces

10387A for Type 303 modems (with cable)

10388A for CCITT V.35 (with cable)

10389A Breakout Box (RS-232C) (with cable)

18062B MIL-STD-188C Interface

18063A RS-449 Interface (with cable)

Accessories

Printer interconnecting cable: 10233A cable connects the 1645A to HP 5150A printer; 36 pin male connector on one end and 50-pin male connector on the other.

*Includes 1645A, 10387A, 10388A, 10389A, 10235A, and interconnecting cables.

DATA COMMUNICATIONS TEST EQUIPMENT

Troubleshooting Computer Communications Networks

Model 1640B



1640B



1640B Description

Selective transparent monitoring and interactive simulation make Hewlett-Packard's 1640B Serial Data Analyzer a valuable tool for quickly locating faulty components in computer networks and most RS-232C (V.24) interfaces. Regardless of network size, system downtime is minimized when the problem source can be isolated rapidly. Model 1640B combines the convenience of programmed operation in real time with the versatility of a variety of triggering modes: character sequences, time intervals, transmission errors, and external. Whether in design, systems integration, preventive maintenance, or on-line debugging, the 1640B aids you in moving efficiently from the symptom to the cause.

As a passive monitor, the Serial Data Analyzer collects status information and serial data on the RS-232C (V.24) interface and records up to 2048 characters in memory. You can monitor all data flow, or restrict your data window to specific data types by suppressing the collection of nonpertinent information. Once connected, the 1640B does not interrupt the communication links, permitting you to troubleshoot the system at operating speeds up to 19.2 kbps HDX and 9.6 Kbps FDX.

In the interactive mode, Model 1640B can simulate the output of a DTE (Data Terminal Equipment) unit or the output of a modem, effectively exercising the entire system for analysis and troubleshooting. Configurations for simulation modes of operation are set quickly on the patch panel matrix which defines the RS-232C (V.24) interface. A separate 1024-character transmission memory contains messages you construct from the 1640B keyboard, either using a ROM or the HP-IB option with a computer-controller, or "copy" from the 1640B monitor memory. Messages may be transmitted directly or separated for sequential transmission. Branch modes are used to simulate a CPU polling sequence, with one of two simulated replies sent conditional on the stimulus message.

HP-IB Operation

The 1640B solves most network problems in a passive sense, or when necessary, as an interactive simulator. For more complex network interaction, the HP-IB option, along with a suitable controller, adds such capabilities as remote control, programming, more mass storage, data manipulation, and hard copy.

Easy-to-Use

Operating 1640B Serial Data Analyzer is simple and easy to learn because its interactive menus set up the analysis modes. Each menu presents the appropriate variables, and specific parameters are chosen from a fixed set with the display cursor and Field Select key, or set directly from the keyboard. The four menu keys across the top of the keyboard are FORMAT, MODE (Monitor or Simulate), TX Entry, and LIST. Once the menu is selected and the parameters set, the actual operation of the 1640B is automatic, freeing you from learning extensive instruction sets and writing programs for specific tests and simulations.

When the HP-IB interface is added, Option 001, you can further simplify set up and operation of the Serial Data Analyzer with Model 10291B PROMs. Each PROM holds two instrument setups for Format, Mode, and TX Entry menus. Up to five PROMs, ten setups, can be installed in the HP-IB board and loaded into the 1640B by setting rear panel switches and pushing the Load pushbutton. This reduces the opportunity for operator error and is particularly convenient for field applications.

Power: 100, 120, 220, 240 Vac; -10% to +5%; 48 to 440 Hz; 150 VA max.

Size: 251 H x 335 W x 546 mm D with handle (9.88" x 13.18" x 21.50"); 445 mm D without handle (17.50").

Weight: net, 11.4 kg (25 lb). Shipping, 15.9 kg (35 lb).

Accessories supplied: one 3 m (10 ft) RS-232C interface cable; Model 10289B Mylar overlay kit, shorting pins and Mylar punch; front panel cover; one 2.3 m (7.5 ft) power cord; one operator's guide; and one service manual.

Ordering Information

Factory Installed Options

001: HP-IB Interface.

002: SDLC (Synchronous Data Link Control)/HDLC (High Level Data Control) interface.

003: LRC, CRC-16, CRC-CCITT Check/Generation
NOTE: Options 002 and 003 cannot be installed simultaneously.

005: Menu ROM, messages in ASCII and EBCDIC.

007: Code Set Board with ASCII, EBCDIC, HEX and space for five other codes.

008: Dataspeed 40/4, ten tests for teletype.

105: IPARS Code ROM for Opt 007.

201: Baudot Code ROM for Opt 007.

202: EBCD Code ROM for Opt 007.

203: Selectric Code ROM for Opt 007.

User Installed Kits

10281A HP-IB Field Kits

10282A SDLC/HDLC Field Kit

10283A LRC/CRC Check Field Kit

NOTE: 10282A and 10283A cannot be installed simultaneously.

10284A 20/60 Current Loop Interface (Simulate Mode Only)

10286A NRZI Interface

10288A Code Set Board Field Kit (Option 007)

10289B Mylar Overlays, 20 blanks

10290B Code ROM (Option 007)*

10291B Menu PROM (Option 001 required)*

10292A Firmware Package for 9825A Desktop Computer

1640B Serial Data Analyzer

*Customer specified code and menu ROM available as specials.



4955A Protocol Analyzer



Description

The HP 4955A Protocol Analyzer is a high level, flexible tool for developing, installing, and maintaining data communications networks. It has the capability to handle diverse applications.

- Packet Switched Networks—X.25
- OSI Model—Levels 1 to 7
- Distributed Network Architectures—SNA
- Network Component Testing
- Network Performance Statistics
- Proprietary Protocols

Software-defined key labels (softkeys) provide systematic, intelligent choices to give you easy operation for analyzing your network. The softkeys allow measurements to be set up quickly, without having to learn a complicated programming language. Keyboard typing is minimized, reducing syntax and entry errors, and providing more accurate analysis.

All data and interface control lead activity acquired by the HP 4955A receives a unique time stamp before it is placed in the RAM buffer or onto tape. This is used for event-to-event timing and to create special timing diagram displays.

Relative time relationships are maintained without having to fill up the 128K Word buffer or tapes with idle line time. The front-end architecture, combined with a high speed trap machine, provide significant capability for many applications:

- 63 Triggers—Data, parity, CRC errors, interface leads, timers, counters.
- Analysis—Real time or postprocessing.
- High Speed—Up to 72 kbps.
- Protocols—X.25, HDLC, BSC, SDLC, SNA, BSC framed X.25, DDCMP, X.21, CCITT#7, user defined character synchronous/asynchronous.
- Softleds—Lead Display automatically configured.

Design of Communication Equipment

The design of data communications equipment requires a development tool with extensive interactive capabilities. The HP 4955A can shorten the development cycle by exercising each level of protocol, from the physical control lead handshakes to high level software interaction. Its high speed capability will meet your current and future network needs.



Data Center Network Analysis

Data center network analysis can provide both quick fault isolation and line utilization statistics. Troubleshooting is straight-forward using the softkey menus, or via HP-IB and a controller, measurements and results can be collected automatically.

Installation

Installation verification is one way to reduce costly field service visits. Dedicated test measurements can be created so that newly-installed equipment can be exercised before leaving the site. When interconnect problems arise, you can be confident your portion of the network operates correctly.

Softkey Guided Measurements

The key to accessing the ease-of-use and flexibility of the HP 4955A lies in the softkeys. Many different display alternatives are available to help you quickly examine the data. The unique Data & State display helps you visualize exactly how the interface control leads handshake with respect to data transmission. There are also dedicated display formats that decode the binary position dependent fields used in bit-oriented protocols. Each type of frame or packet is identified along with the Level 2 (HDLC) and Level 3 (X.25) protocol fields. Any menu or amount of buffer data may be output directly to an HP 2671G or 2673A printer, maintaining its displayed format.

When creating a monitor or simulate measurement, the softkeys present you with guided entry choices. As each selection is made from the softkeys, the next valid set of choices is presented. No special programming skills or obscure code words need to be learned. Dynamic softkey relabeling makes entry of bit-oriented triggers and send strings especially easy.

Instead of memorizing or looking up binary values in a table, you simply select the softkey with the appropriate command mnemonic, and the correct field will automatically be filled in. Once any menu is complete, it can be stored onto tape, so only a file name needs to be recalled for configuring measurements.

Expand Your Capability

The optional BASIC programming language can be used for more sophisticated analysis, or for any of your unique, dedicated applications. It uses many of the same routines as the menus, therefore maintaining the softkey ease-of-use, while giving you the ability to write your own programs when needed. Display control allows proprietary or higher level protocols to be decoded, and statistical information to be presented in a graphic format.

General Operating Characteristics

Protocols: X.25, HDLC, BSC, SDLC, user defined character synchronous/asynchronous.

Application software available supplies custom display formats to decode SNA, BSC framed X.25, DDCMP, X.21, and CCITT#7.

Data transfer rates: 50 bps to 72 kbps using internal clock. 4955A can properly frame data at higher rates using an external clock.

Data transmission modes: synchronous, asynchronous, and synchronous NRZI.

Capture memory: 128K Words for storing data, timing, and interface lead status.

Character framing: 5, 6, 7, or 8 information bits plus parity.

Data codes: ASCII, EBCDIC, Baudot, EBCD, IPARS, Selectric, and Transcode are provided. The user may quickly define other codes using the supplied application program, and store them to tape for future use.

Error checking: CRC-CCITT, CRC-16, CRC-12, CRC-6, and LRC.

Parity: Odd, Even, None, and Ignore

Triggers: 63 - consisting of characters, errors, or interface lead transitions. External TTL pulse trigger-in and trigger-out ports are provided. Bit and character masking, and "not" characters are supported. Trigger events can be selectively displayed and stored to tape. Date and time are also stored for future reference.

Timers and Counters (5 of each)

Timers: 65535 msec., max.; 1 msec. resolution and accuracy.

Counters: up to 10,000.

Date and time clock: battery backup.

Dual tape drives: cartridges store buffer data and timing information, menu configurations, custom data codes, application programs, and BASIC programs. The entire contents of the buffer memory may be stored on a single data cartridge.

BASIC programming language (option 001): sample datacomm extensions to BASIC:

START/STOP (TIMER, TAPE, DISPLAY).

SEND. . .

HIGHLIGHT. . .

DECODE FRAME/PACKET

SET LEAD. . .

DISPLAY. . .

EMULATE (DTE/DCE).

Display: a 23 cm (9 in.) diagonal, 25 line by 80 character display. Double size characters are selectable.

Keyboard: the full ASCII keyboard pivots and locks at any angle for convenient desk, bench, rack, or floor standing operation.

HP-IB (IEEE-488-1978)

a) Direct hard copy output of any display to an HP 2671G or 2673A printer.

b) Remote operation using an HP-IB controller.

Security: inhibit simulation and data recording capability.

Self test: extensive self-test and functional verification routines will isolate failures to the board assembly level. Built-in signature analysis permits fault isolation to the component level.

Specifications

Electromagnetic compatibility: type tested for compliance with VDE 0871 Level B, Radiated and Conducted.

Primary channel clock accuracy: 0.005%.

Temperature: operating 0°C to +55°C (+32°F to +131°F)*.

Storage -40°C to +75°C (-40°F to +167°F).

*Tape drives should only be operated from +5°C to +40°C (+41°F to +104°F).

Altitude: operating 4600 m (15 000 ft).

Storage 15 300 m (50 000 ft).

Dimensions (overall, excluding pouch)

Length: 654 mm (25.7 in.)

Width: 436 mm (17.2 in.)

Height: 201 mm (7.9 in.)

Rack Height: 177 mm (6.97 in.)

Weight: net 22 kg (49 lb).

Shipping 32 kg (70 lb)

Power requirements: 110, 220, Vac. -15% to +15%, 48 to 66 Hz single phase; 250 VA max.

HP-IB compatibility is: SH1, AH1, T2, L2, SR1, RL1, PPO, DC1, DTO, C1, C2, C4, C27, and E2.

Ordering Information

4955A Protocol Analyzer (Includes 18135A)

Option 001: BASIC programming language

Option 002: Deletes 18135A

Option 004: Deletes second tape drive and pouch

Option 908: Rack mount kit (5061-0078)

Option 910: Extra Operating Manual

Physical Interface Pods:

18135A RS-232C/V.24 Interface Pod

18136A RS-449 Interface Pod

18137A V.35 Interface Pod

18138A X.21 Interface Kit*

18139A MIL-188C Interface Pod

Other Accessories:

18140A Breakout Box (for all interfaces)

18141A Service Kit

18142A BASIC Programming Language Field Retrofit Kit

98200A Certified blank tape cartridge (set of five)

Transit Case (9211-2662)

One Day 4955A Training (+24A)

*Used in conjunction with 18138A



COMPUTERS, PERIPHERALS & CALCULATORS

Welcome to the computer section of HP's catalog. This chart briefly summarizes HP's wide range of Computer Group products. We make everything from handheld calculators for science and engineering to mainframe computers for business and manufacturing applications as well as a variety of periph-

als like printers, plotters and data communications devices.

Most of the personal and desktop computers and all of the HP 1000 models are HP-IB compatible. Use this chart to locate the type of computer you are interested in, and then turn to the page with complete information

on that product.

If you have more questions about a computer or its usefulness for your application, please call the local Hewlett-Packard Sales and Service Office listed in the telephone directory white pages or see pages 681-688. Ask for the Computer Department.

	HP Computer Products	Applications		Operating System	Language	Display	Memory	
		Focus	Software					
PERSONAL	HP-10C, 11C, 15C	science, engineering	HP-11C Solutions Handbook HP-15C Advanced Functions Handbook	proprietary	RPN	12-character LCD	79,203,448 program lines (respectively)	
	HP-12C	financial	HP-12C Real Estate & Leasing Applications Handbooks HP-12C Solutions Handbook				99 program lines	
	HP-16C	digital electronics, computer science	—				203 program lines	
	HP-97	science, business engineering				12-character LED	244 program lines	
	HP-41C/41CV					12-character LCD alphanumeric	.44 to 6.43 Kb / 2.23 to 6.43 Kb	
	HP-75C	portable personal for business, science, engineering	VisiCalc®, math, text formatter, surveying, data communications, graphics	ROM 48 Kb (CMOS Series 80 CPU)	BASIC	32-character LCD, 96-character line, alphanumeric	16 Kb-24 Kb RAM 96 Kb ROM	
	HP-85B	portable personal/technical/analysis/instrument control	See p. 593	ROM 48 K	BASIC, Assembly	5" diagonal built-in	32 Kb	
	HP-86B	personal/professional/analysis		standard ROM 56K; opt. CP/M®, opt. UCSD p-System	BASIC, Assembly, Pascal, FORTRAN 77	9" or 12" monitor	128-640Kb	
	HP-87XM	personal/professional/analysis/instrument control		standard ROM 48K; opt. CP/M®, opt. UCSD p-System		10" diagonal built-in	128-640Kb	
HP 9816	high performance personal/technical analysis	Context MBA®, graphics presentations, statistics, terminal emulation, general business and technical	ROM- or RAM-based, proprietary, single user; opt. CP/M-68K®	BASIC, C, HPL, FORTRAN		128-768 Kb		
SCIENTIFIC	HP 9826A	computer-aided test, instrument control	statistics, engineering design/analysis, VisiCalc®	ROM- or RAM-based, proprietary, single user	BASIC, HPL, Pascal	CRT	64Kb-2Mb	
	HP 9836A	computer-aided engineering, graphics						
	HP 9920	computer-aided test	graphics presentations, statistics, terminal emulation, general business and technical	ROM- or RAM-based, proprietary, single user	BASIC, Pascal	remote CRT	128Kb-3.8Mb	
	HP 9000 Family Model 20	engineering workstations, stand-alone computation	data base mgt., graphics, datacomm, mech. design, EE	BASIC or HP-UX	BASIC, C, Pascal, FORTRAN	13" CRT B/W or color	512Kb-2.5Mb	
	Model 30	engineering workstations, OEM, instrument control	data base mgt., graphics, mech. design, electrical engineering	HP-UX	Pascal, C, FORTRAN	HP terminals		
	Model 40	single or multi-user workstation systems, OEM						
REAL TIME	HP 1000 Computer Microsystems	computer-aided manufacturing, real-time, space sensitive applications	data base management, graphics	multi-user, multi-tasking, real-time	FORTRAN 77, Pascal, BASIC, Assembler	CRT	512Kb-6Mb	
	HP 1000 Real-Time Computer Systems	computer-aided manufacturing, general purpose OEM					256-896Kb	
BUSINESS	HP 250 Models 20, 25, 30, 40, 50	small business, departments of large companies	text processing, business graphics, financial accounting, bill of materials processing	multi-user multi-tasking	HP 250 Business BASIC		512Kb-3Mb	
	HP 3000 Family Series 39	business	IMAGE, QUERY, KSAM, HPSLATE, HPWORD, TDP/3000, HPMenu, HPEasyChart, HPDRAW, DSG/3000, IFS/3000, HPDesk Manager, HPToolset, RAPID, OPT/3000, APS/3000, SFD/3000, OM/3000, MM/3000, PM/3000, HP Financial Accounting	MPE	FORTRAN, BASIC, Pascal, COBOL, RPG, SPL, TRANSACT	All HP terminals	1-4Mb	
	Series 42						2-8Mb	
	Series 48							
	Series 68							

VisiCalc® is a registered trademark of Software Arts Products Corporation.
UCSD p-System is a trademark of The Regents of the University of California.

Context MBA is a trademark of Context Management Systems.
CP/M-68K is a trademark of Digital Research, Inc.



Storage	Interface Options	I/O Slots	Datacom	HP Plotters	HP Printers		For more info. see page
—	—	—	—	—	—		584
—	—	—	—	—	—		
—	—	—	—	—	—		
built-in mag card	—	—	—	—	built-in thermal printer		
memory and extension modules, 82161A cassette	HP-IL, HP-IB, RS-232C, GPIO, Series 80, Video	4	82168A modem, extended I/O module	7470A	82143A, 82162A, 82905B, 2671A/G		585
built-in mag card reader, 82700A memory module, 82161A cassette drive	HP-IL built-in, HP-IB, GPIO, RS-232C, Series 80, Video	1 (up to 30 peripherals)	82168A modem, datacom software pac, I/O Utilities Solutions Book		82162A, 82905B, 2671A/G		588
3½", 5¼" and 8" floppies, Winchester drives	HP-IB, HP-IL, HP-IL/HP-IB, Serial (RS-232C), GPIO, BCD, parallel printer, data link	4	modem, datacom software pac	7470A, 7475A, 7580B, 7585B, 9872T, 9111A graphics tablet	82905B, 89206A, 2601A, 2602A, 2670 series, 2932A		593
			modem, datacom software pac, TERM/80 terminal emulation system				
flexible or hard discs	HP-IB, Serial, BCD, 16-bit parallel, datacom, color video	1	async, data link, shared resource management	7580B, 7585B, 7470A, 7475A, 9872T, 9111A graphics tablet	2602A, 2631G, 2671B/G, 2673G, 9876A		602
		4					
disc, EPROM, bubble memory	HP-IB, Serial, BCD, 16-bit parallel	15	async, data link	7580B, 7585B, 7470A, 9872T	2602A, 2631G, 2671B/G, 2673G, 9876A		
integrated flex/hard disc plus external flex and hard discs	HP-IB, 16-bit parallel, RS-232C, 8-channel multiplex	4	async, RJE, Local Area Network, SRM	7470A, 7475A, 7580B, 7585B, 7220T, 7221T, 9872T	2608S, 2631B/G, 2563		603
		7	async, RJE, Local Area Network				
CTU, hard disc, floppy, mag tape	Serial, HP-IB, 8/16-bit duplex	7-10	async, bisync, HDLC, DSN, LAP-B(X.25), RJE	7470A, 7475A, 7580B, 7585B, 9872T, 9111A graphics tablet	2601A, 2608S, 2631B, 89205B, 2671A/G, 2673A		605
hard disc, mag tape		13					
integrated 4.7Mb and 9.7Mb Winchester discs, 7908P, 7911P, 7912P	—	5 std 10 max.	RJE DSN	7220T, 7221T, 7470A, 7475A	2601A, 2602A, 2608A, 2631B, 82905B		601
7911P, 7912P, 7914P, 7901M/S, 7925M/S, 7933H, 7935H, 7970E, 7976A, 9895A	—	13	RJE, MRJE, IMF DS w/bisync or X.25, MTS.	7220T, 7221T, 7580B, 7585B, 7470A, 7475A	2601A, 2602A, 2608A, 2631B, 2617A, 2619A, 2680A		601
		26	PBX, ADCC (not w/series 68), ATP (not w/series 39 or 42)				
		24 expandable to 48					

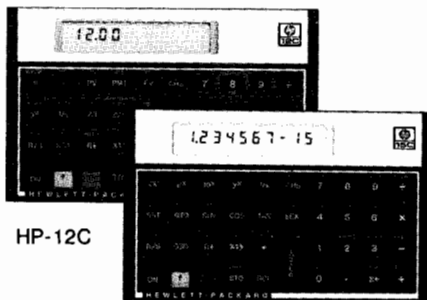

HP-12C

HP-15C

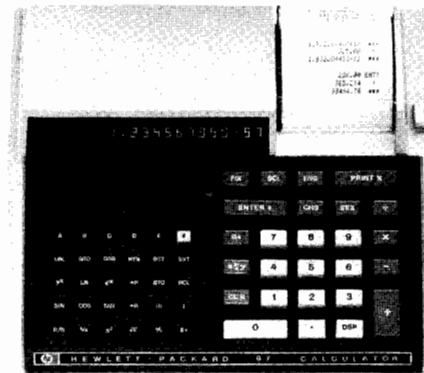

HP-97

Series 10 Professional Calculators

HP-12C Advanced Financial Programmable with Continuous Memory

The HP-12C is HP's most powerful dedicated financial calculator. With its special functions, programmability, Continuous Memory, and liquid-crystal display, this calculator is ideal for solving most business and financial problems in or out of the office. The HP-12C features basic time and money functions, Net Present Value, Internal Rate of Return, plus a bond function which calculates yield-to-maturity and price. For additional push-button solutions, users can write their own programs, or, take advantage of HP's prewritten software solutions for specific applications.

The HP-12C comes complete with detailed Owner's Handbook and Problem-Solving Guide, long-life disposable batteries, and a soft, carrying case.

Size: 12.7 x 8.0 x 1.5 cm (5 x 3 $\frac{1}{8}$ x $\frac{5}{16}$ in)

HP-16C Programmable Calculator for Computer Science

The HP-16C is a programmable calculator specifically designed for computer science and digital electronic applications. With the HP-16C's number base modes, users can easily convert between binary, octal, decimal and hexadecimal bases. The advanced programmability of the HP-16C enables the user to call and edit programs easily. The HP-16C has extensive bit manipulation capability: shift, rotate, set, test, checksum and mask. Select word size, 1's and 2's complements and unsigned mode. Through a program, the user can emulate instructions of most available processors. The calculator has four logical Boolean operators: AND, OR, XOR, and NOT.

The HP-16C comes complete with Owner's Handbook, long-life disposable batteries, and a soft, carrying case.

Size: 12.7 x 8.0 x 1.5 cm (5 x 3 $\frac{1}{8}$ x $\frac{5}{16}$ in)

HP-10C Programmable Scientific

The HP-10C provides basic power and programmability in a lightweight, slim-line design. Programming tools include: 79 program lines, program review, conditional and unconditional branching. You can allocate the HP-10C's memory between program lines and storage registers. Functions include trigonometrics, logarithms, two-variable statistics, summations, linear regression, correlation coefficient, and factorial. The HP-10C will automatically turn itself off after several minutes of discontinued use. The calculator has a self-check routine and provides the user with specific error messages.

The HP-10C comes complete with Owner's Handbook, long-life disposable batteries, and a soft, carrying case.

Size: 12.7 x 8 x 1.5 cm (5 x 3 $\frac{1}{8}$ x $\frac{5}{16}$ in)

HP-11C Advanced Programmable Scientific

Programming on the HP-11C is easy to learn and easy to use. The HP-11C has subroutine and indirect addressing capability, conditional tests and flags. Insert new instructions by using the "Go To" key to access any part of a program. Delete a program line by pressing the Backarrow key. A convenient User Mode saves time and keystrokes—at the touch of a single key, branch to any one of five independent programs. Dedicated functions include: trigonometrics, hy-

perbolics and inverses, permutations and combinations, and a random number generator.

The HP-11C comes complete with Owner's Handbook and Problem-Solving Guide, long-life disposable batteries, and a soft, carrying case.

Size: 12.7 x 8 x 1.5 cm (5 x 3 $\frac{1}{8}$ x $\frac{5}{16}$ in)

HP-15C Advanced Programmable with Continuous Memory and Matrix Functions

The HP-15C is an advanced programmable calculator with special functions that enable the user to solve problems involving matrices and complex arithmetic. The HP-15C's function set and programming tools are combined in a slim-line design to provide maximum portability. With the HP-15C's built-in matrix functions the user can operate with up to five matrices, (a maximum of 64 elements). Perform transpositions, determine norms, and find determinants with the HP-15C. The calculator has two parallel stacks, one for the real and another for the imaginary part of a complex number. It can also perform calculations with complex matrices. The calculator has solve and integrate functions. Advanced programming features include: 448 program lines, label addressing, insert/delete editing, 7 subroutine levels, program review, 10 flags, and conditional tests.

The HP-15C comes complete with Owner's Handbook, long-life disposable batteries, and a soft, carrying case.

Size: 12.7 x 8 x 1.5 cm (5 x 3 $\frac{1}{8}$ x $\frac{5}{16}$ in)

Series 10 Software

HP-11C Solutions Handbook

HP-12C Solutions Handbook

HP-12C Real Estate Applications

HP-12C Training Guide

HP-12C Leasing Applications

HP-15C Advanced Functions Handbook

HP-97 Desktop Programmable Printing Calculator

The HP-97 is designed for the professional who requires an integrated system with the added convenience of a built-in thermal printer and magnetic card reader. The printer is a valuable aid in editing programs or long calculations. With the magnetic card reader, the user can record from or load information into the calculator by using space-saving magnetic cards. Editing features enable the user to easily correct and modify programs.

The HP-97 comes complete with Owner's Handbook, Standard Pac with 40 magnetic cards, card holder, and manual, rechargeable battery pack, recharger/AC adapter, programming pad, soft carrying case, and two rolls of thermal paper.

Size: 64 x 229 x 203 mm (2.5 x 9 x 8 in)

Ordering Information

HP-10C

HP-11C

HP-12C

HP-15C

HP-16C

HP-97

Series 10 Software

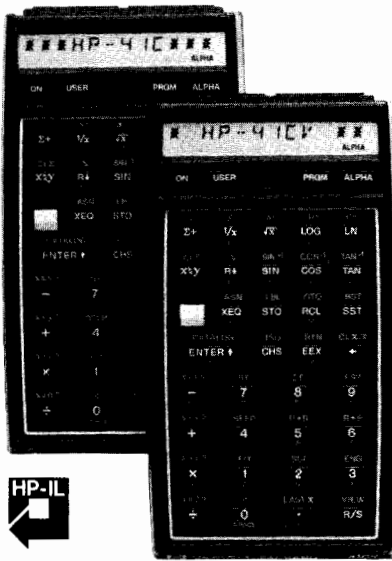

HP-41C and HP-41CV

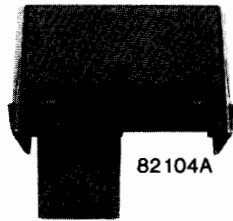

82104A

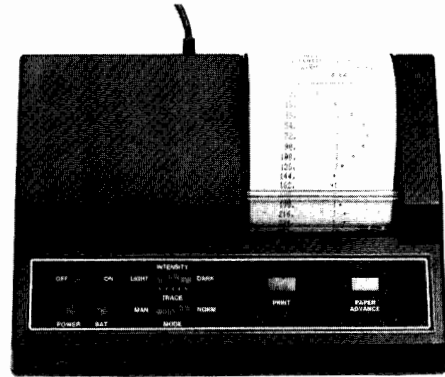

82143A

Memory Modules

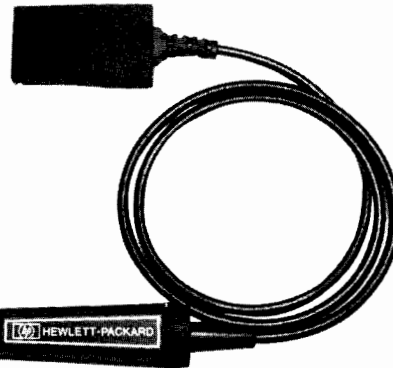
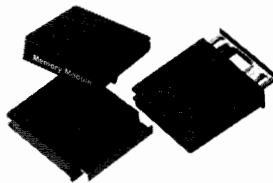

82153A

Series 40 Handheld Computers

The HP-41C and HP-41CV Handheld Computers provide the heart of an expanding computational, data acquisition and instrument control system. Both models are virtually identical, the only difference lies in the amount of built-in memory: 441 bytes for the HP-41C, 2,233 bytes for the HP-41CV. Maximum memory expansion for both machines is 6,454 bytes through the use of Memory Modules and Extension Modules.

The alpha capability of the HP-41 enables the user to label programs with easy-to-remember names. Each program is autonomous and each can have up to 100 different local labels for branching within a program. The HP-41 also features up to 6 levels of subroutines, 10 conditional tests, 56 internal flags, powerful loop control, indirect addressing, and both local and global branching.

Over 128 separate operations comprise the total HP-41 function catalog. Functions and programs can be assigned to almost any key. The HP-41 comes with keyboard overlays and a set of user labels to help facilitate customization of the HP-41.

Key in any combination of letters and numbers up to 24 characters wide and display 12 characters at a time. A complete system of status annunciators indicate mode conditions. Error messages pinpoint calculation errors and ten different tones provide aural feedback. Continuous Memory saves programs and data even when the computer is turned off. (For additional specifications, refer to the Comparison Chart on page 587.)

A variety of dedicated, plug-in peripherals expand the capabilities of the HP-41. In addition, both handheld computers are HP-IL compatible. Simply plug in the HP 82160A HP-IL Module to connect up to 30 HP-IL devices using only one port. Through HP-IL, the HP-41 is capable of transmitting and receiving data, and performing a wide variety of control functions. With the help of HP-IL interface converters, Series 40 Handheld Computers can communicate with larger computers, peripherals, modems, terminals and instruments.

Surrounding the HP-41 is a broad range of software solutions. Choose from HP-written Application Pacs and Solutions Books, and

Users' Library programs. Hewlett-Packard offers a Custom Products Program for those who require customized software solutions in large quantities. More information on Custom Products is available on page 591.

Size: 33 x 79 x 144 mm (1.3 x 3.1 x 5.7 in.)

HP 82104A Card Reader

The HP-41 Card Reader is a valuable dedicated peripheral allowing programs and data to be saved on magnetic cards. Each card contains 32 registers, 16 per side. Adds over 30 card reader control functions to the HP-41. Keeps track of cards as they are read and prompts for the next card. A security feature permits a program to be run, but not reviewed or altered through normal operations. Also reads HP-67/97 program cards, making all necessary translations into HP-41 code.

HP 82143A Thermal Printer/Plotter

Portable, whisper-quiet, and battery-powered, the HP 82143A plugs directly into an I/O port in the HP-41. Provides numeric, upper- and lowercase alpha, double-wide characters, high-resolution plotting capabilities, and intensity control for optimum contrast and readability. Allows for user-defined special characters.

HP 82153A Optical Wand

Easily inputs data or programs into the HP-41. Pass the HP 82153A Optical Wand across a printed page of HP bar code. The wand translates all programs and data into usable form and loads it into the HP-41. Most HP-41 software is available in HP bar code, including Users' Library programs and Solutions Books.

Ordering Information

HP-41C

HP-41CV

HP 82104A Card Reader

HP 82143A Thermal Printer/Plotter

HP 82153A Optical Wand

Series 40 Modules**HP 82106A Memory Module**

Each module contains an additional 64 registers that can be allocated as program memory or storage registers, or any combination. Four Memory Modules can be added to the HP-41C for a total of 319 storage registers or 2,233 bytes. (For the HP-41C only.)

HP 82170A Quad Memory Module

The Quad Memory Module contains 256 data storage registers or 1,792 program bytes and expands the HP-41C to 319 storage registers or 2,233 program bytes using only one port. (For the HP-41C only.)

HP 82180A Extended Functions/Memory Module

This module increases the HP-41 programming function set by adding such functions as programmable SIZE, programmable AS-SIGN and string functions. This module also provides memory management functions for accessing extended memory and 868 bytes of solid-state mass storage.

HP 82181A Extended Memory Module

This module provides an additional 238 data registers or 1,666 bytes of solid-state mass storage to the HP-41. Up to two HP 82181A's may be used in the HP-41. (HP 82180A Module is required when using the HP 82181A.)

HP 82182A Time Module

The Time Module expands the HP-41 computing system with time information and time-controlled operations. With this module, the HP-41 can become a time-scheduled system controller, an alarm clock, an appointment reminder, a calendar, a timer, even an advanced stopwatch.

HP 82183A Extended I/O Module

Provides easy-to-use I/O functions which enhance the HP-41's control of the HP-IL loop. This 4K-byte module provides 59 functions beyond those provided by the HP 82160A HP-IL Module. These functions enhance mass storage, character manipulation, HP-IL control and advanced control of the HP-41 and devices on the HP-IL loop.

HP 82184A Plotter Module

The Plotter Module provides plotting capability for the HP-41 and HP 7470A Plotter, Opt 003. Plotting programs are included in the module for quick and easy generation of high-quality graphics. With the module, develop graphics programs as well as plot and print HP bar code on the HP 7470A and the HP 82162A Printer/Plotter.

HP 82160A HP-IL Interface Module

The HP-IL Interface Module plugs into any one of the four ports in the HP-41, connecting the HP-41 Handheld Computer with an ever-growing family of HP-IL peripherals and instruments. The module gives the HP-41 control of up to 30 devices on the loop. There are three function sets supplied by the HP-IL Module: printer, mass storage, and general input/output (I/O).

Physical Specifications

2.8 x 1.2 x 0.4 cm (1.1" x 0.5" x 0.2")

Cable length: (two attached cables) 80 cm each (31 in. each)

Data Transfer Rate

150 bytes per second (Typical HP-41 transfer rates)

HP-41 Application Pacs

Every Application Pac comes with a comprehensive manual, an application module and, when applicable, a keyboard overlay. Choose from:

- Aviation (for pre-flight use)
- Clinical Lab & Nuclear Medicine
- Circuit Analysis
- Financial Decisions
- Mathematics
- Games
- Home Management
- Real Estate
- Thermal & Transport Science
- Petroleum Fluids
- Securities
- Standard Applications
- Statistics
- Stress Analysis-Mechanical Engineers
- Structural Analysis-Civil Engineers
- Surveying
- Machine Design
- Navigation
- Auto/Start Duplication ROM
- HP-41 Development Module

HP-41 Solution Books**Business:**

- Business Statistics/Marketing/Sales
- Home Construction Estimating
- Lending, Savings, & Leasing
- Real Estate
- Small Business

Engineering:

- Antennas
- Chemical Engineering
- Civil Engineering
- Control Systems
- Electrical Engineering
- Fluid Dynamics & Hydraulics
- Heating, Ventilating & Air Conditioning
- Mechanical Engineering
- Solar Engineering
- Structural Design (cassette based)

Computation:

- Geometry
- High-Level Math
- Test Statistics

Other:

- Calendars
- Chemistry
- Games I
- Games II
- Optometry I (General)
- Optometry II (Contact Lenses)
- Physics
- Surveying
- Taxes
- Time Module Solutions I

Ordering Information

HP 82106A Memory Module

HP 82160A HP-IL Interface Module

HP 82170A Quad Memory Module

HP 82180A Extended Functions/Memory Module

HP 82181A Extended Memory Module

HP 82182A Time Module

HP 82183A Extended I/O Module

HP 82184A Plotter Module

00041-15042 Auto/Start ROM

00041-15043 Development Module

Application Pacs

Solution Books

COMPUTERS, PERIPHERALS & CALCULATORS

587

Personal Computation

Comparison Chart



	Financial		Advanced		Scientific		Computer Science
	HP-12C	HP-97	HP-41C/CV	HP-15C	HP-11C	HP-10C	HP-16C
Operating Features							
RPN logic system	●	●	●	●	●	●	●
Error recovery (last x)	●	●	●	●	●	●	●
Maximum number of storage registers	20	26	919*	67	21	10	101R
Continuous Memory	●	●	●	●	●	●	●
Maximum number of digits displayed	10	10	10	10	10	10	10F
Number of digits used in computation	10	10	10	10	10	10	10D
Rechargeable batteries/AC recharger	●	●	●	●	●	●	●
Long-life disposable batteries	●	●	●	●	●	●	●
Software Support							
Application Pacs (with modules)			●				
Application Pacs (with magnetic cards)		●					
Solution Books/Handbooks	●	●	●	●	●		
Users' Library programs		●	●				
Accessory Support							
Memory Modules			●+				
Extended Memory Modules			●				
Enhancement Modules			●				
Reserve power pack		●					
Security cradle/cable		●					
Multipurpose rechargeable battery pack			●				
General Features							
One-year limited warranty	●	●	●	●	●	●	●
Display separates thousands	●		●	●	●	●	●F
Diagnostic self-check	●	S	●	●	●	●	●
Error codes/messages	●		●	●	●	●	●
Redefinable keys		●	●	●	●		
Alpha mode/display/keyboard			●	●	●		
Status annunciators	●		●	●	●	●	●
Automatic power off	●		●	●	●	●	●
Audible tones			●				
Programming Features							
Maximum number of program lines	99	244	6,433*	448	203	79	203
Shared program/storage memory	●		●	●	●	●	●
Alpha program labels			●				
Single-character program labels		10	56	5	5		6
Numeric program labels		10	100	20	10		10
Program review (single- and backstep)	●	●	●	●	●	●	●
Insert/delete editing	●	●	●	●	●	●	●
GO TO	●	●	●	●	●	●	●
Levels of subroutines		3	6	7	4		4
Conditional tests	2	8	10	12	8	2	8
Flags		4	56	10	2		6
Pause	●	●	●	●	●	●	●
Indexed looping (DSE, ISG)		●	●	●	●		
Indirect control of:							
Data storage/recall		●	●	●	●		●
Storage register arithmetic		●	●	●	●		●
Branching		●	●	●	●		●
Looping		●	●	●	●		●
Display format		●	●	●	●		●
Flags		●	●	●	●		●
Integer/fraction truncation	●	●	●	●	●	●	●
Alpha string manipulation			●				
Dedicated Input/Output Devices							
Card Reader		●	P				
Printer/Plotter		●	P				
Optical wand			P				
HP-IL Peripherals							
Digital Cassette Drive			P				
Thermal Printer/Plotter			P				
Impact Printer (80-column)			P				

	Financial		Advanced		Scientific		Computer Science
	HP-12C	HP-97	HP-41C/CV	HP-15C	HP-11C	HP-10C	HP-16C
HP-IL Interfaces:							
HP-IB			P				
RS-232C			P				
GPIO			P				
Series 80			P				
General Arithmetic Features							
+ , - , X , / , \sqrt{x} , 1/x , CHS	●	●	●	●	●	●	●
Ln x , e ^x	●	●	●	●	●	●	●
y ^x , Log x , 10 ^x , x ² , π	●	●	●	●	●	●	●
Absolute value	●	●	●	●	●	●	●
Storage register arithmetic	●	●	●	●	●	●	●
Business Features							
Maximum number of dedicated financial registers	5						
Solves for:							
Number of periods (n), compound interest (i), present value (PV), payment, (PMT), future value (FV)	●	S	S	S	S	S	
Simple interest	●	S	S		S		
Amortization (accumulated interest/remaining balance)	●	S	S		S		
Net present value (NPV) and internal rate of return (IRR)	●	S	S	S			
Beginning/end of period selection	●	S	S	S	S		
Calendar functions	●	S	S				
Bond:							
Yield-to-maturity	●	S	S				
Price	●	S	S				
Depreciation (SL, DB, SOYD)	●	S	S		S		
Scientific Features							
Solve (root finder)		S	S	●	S		
Integrate (numerical integration)		S	S	●	S		
Matrix operations		S	S	●			
Complex functions		S	S	●	S		
Bit manipulation							●
Boolean operators (NOT, OR, AND, XOR)			S				●
Complement modes (1's, 2's, unsigned)							●
Numerical base arithmetic (binary, octal decimal, hexadecimal)		S	●S				●
Metric conversions		S	S				
Trigonometric functions:							
Modes (degrees, radians, grads)		●	●	●	●	●	●
Sin, Sin ⁻¹ , Cos, Cos ⁻¹		●	●	●	●	●	●
Tan, Tan ⁻¹		●	●	●	●	●	●
Hyperbolic and inverses		S	S	●	●	●	●
Rectangular \leftrightarrow polar coordinates		●	●	●	●	●	●
Decimal angle \leftrightarrow angle in degrees (hrs)/min/sec.		●	●	●	●	●	●
Degrees \leftrightarrow radians		●	●	●	●	●	●
Fixed and scientific notation	●	●	●	●	●	●	●
Engineering notation	●	●	●	●	●	●	●F
Automatic under/overflow into scientific	●	●	●	●	●	●	●F
Statistical Functions							
Percent	●	●	●	●	●	●	●
Percent change	●	●	●	●	●	●	●
Percent total	●	●	●	●	●	●	●
Mean/standard deviation (1- or 2-variable)	●	●	●	●	●	●	●
n, Σx , Σx^2 , Σy , Σy^2 , Σxy	●	●	●	●	●	●	●
Weighted mean	●	S	S				
Linear regression or estimate	●	S	S	●	●	●	●
Correlation coefficient	●	S	S	●	●	●	●
Normal distribution	S	S	S	S	S		
Factorial function	●	●	●	●	●	●	●
Gamma function	●	S	S	●	●	●	●
Random number generator	S	S	S	●	●		

Symbols

● Built-in feature or function.

+ To be used with the HP-41C only.

* The HP-41C has 63 registers or 441 program bytes built in, (expandable to 922 registers or 6,454 bytes with memory modules and extended memory modules).
The HP-41CV has 319 registers or 2,233 bytes built in, (expandable to 6,454 bytes).

P Peripheral available

S Available in software form

F Using Floating-Point Decimal Mode.

D Ten digits are used in computation when in Floating-Point Decimal Mode. Word size is user-specifiable in other modes, up to 64 bits.

R 16-bit registers

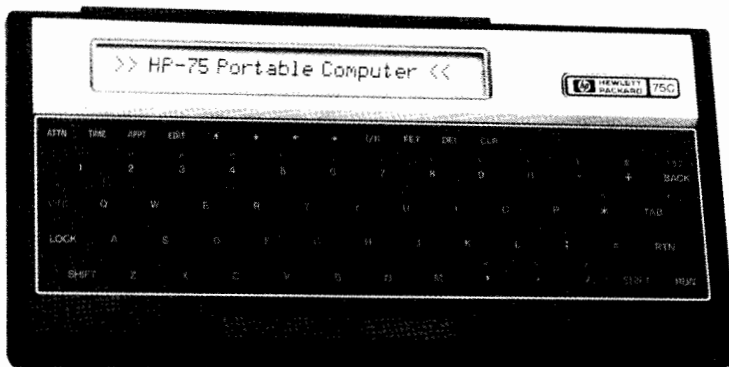

HP-75C



Series 70 Portable Computer

The HP-75 is the portable computer for professionals on the move. As powerful as a personal computer, as small as a book, the HP-75 gives the answers whenever and wherever they are needed. This battery-powered portable computer matches the information handling capabilities and accuracy of larger desktop computers. A fully-integrated computer, the HP-75 may be used alone or configured as part of an HP-IL briefcase system or an HP-IL desktop system.

The HP-75 contains a CMOS version of a Series 80 Personal Computer CPU for speed and accuracy. The built-in 48K-byte ROM BASIC operating system has 167 system commands, including 41 numeric functions, to choose from. With the HP-75's multiple file structure, any number of files (up to available memory space) may be in memory at the same time. The built-in text file allows keeping text and BASIC files.

The HP-75 offers a maximum of 24K bytes of RAM, with 16K bytes built-in and an optional 8K-byte memory module (HP 82700A). Three ports hold up to 96K bytes of applications ROM modules. Continuous Memory assures that data and programs will be saved even when the computer is turned off. A typewriter-like keyboard allows for fast data entry, and more than 190 key combinations can be redefined. Simple keystrokes call up a "hidden" numeric keypad for quick input of numeric data.

The HP-IL interface built into the HP-75 is the key to the conversion of this portable computer into a full-fledged, versatile system. Connection of up to 30 devices for mass-storage on cassettes, printing, plotting, measurement and access to larger systems is easily accomplished. HP-IL interfaces to HP-IB, RS-232, GPIO, and HP Series 80 Personal Computers. Battery power assures portability. Three rechargeable nickel-cadmium batteries permit two to three weeks of normal use between charges, or 20 to 30 hours of continuous use.

A built-in appointment function provides personal scheduling, audio alarm, and message options. TIME mode calls up the system clock and allows the execution of time- and date-dependent programs. The user can run a program at a specified date and time or use the HP-75 for real-time data acquisition, taking measurements and controlling instruments and peripherals without user supervision. The appointment mode allows the storage of more than 16,000 future appointments. When each comes due, the HP-75 turns itself on, emits one of nine audible alarms and displays the reminder message.

A built-in card reader allows the use of small, inexpensive magnetic cards for storage of programs, text files, data files and keyboard redefinitions, up to a capacity of 1.3K bytes per card.

The liquid-crystal display acts as a 32-character window on a 96-character line. View the entire line by scrolling. The 256-character set includes both upper- and lowercase ASCII characters with true descenders, as well as several special characters.

The HP-75 comes complete with Owner's Manual, Reference Manual, Owner's Pac, Keyboard Overlay Kit, field case, rechargeable battery pack, recharger/AC adapter, HP-IL cables, and card holder.
Size: 12.7 x 25.4 x 3.2 cm (5 x 10 x 1.25 in.)
Weight: 737.1 g (26 oz)

HP 82700A 8K-Byte Memory Module

This module gives an additional 8K bytes of programmable memory. Plug it into the HP-75 for a maximum of 24K bytes of RAM.

Series 70 Application Pacs

Offering turnkey solutions, each Application Pac comes with a comprehensive manual, a plug-in application module, and when applicable, prerecorded magnetic cards, a keyboard overlay, and quick reference card.

Choose from:

- Data Communications
- Math
- Surveying
- Text Formatter
- VisiCalc®

Series 70 Solutions Books

All Solutions Books come with complete documentation. Magnetic cards and mini data cassettes are also available.

- Electronics
- Finance
- Games I
- Games II
- Graphics
- I/O Utilities
- Mass Media
- Duplication/Privacy
- Math I
- Math II
- Math III
- Real Estate
- Statistics
- Test Statistics

Ordering Information

HP-75C
 HP 82700A
 Application Pacs
 Solutions Books

VisiCalc® is a trademark of VisiCorp.

HP 82161A

HP 82162A

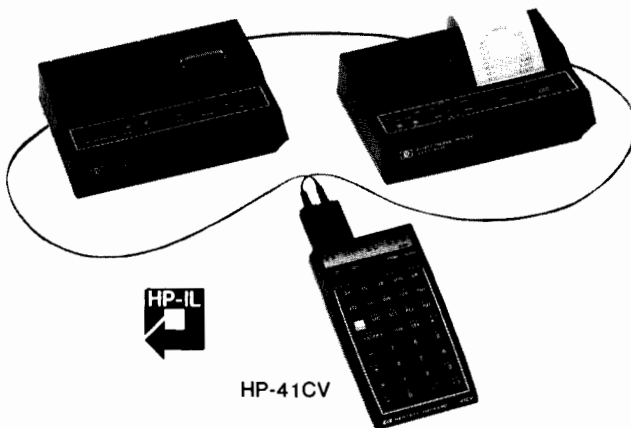

HP 82161A Digital Cassette Drive

The Digital Cassette Drive uses a digital-quality mini-cassette, capable of storing up to 128 kbytes of information. Rewind time is under 30 seconds and read/write operations are executed at nine inches per second, with search speed at 30 inches per second. All tape movement is under microprocessor control and buffer space is provided in the Drive for temporary storage of directory information to help minimize access time and tape motion. The Cassette Drive can locate files when under program control. The Digital Cassette Drive also features STANDBY mode, enabling an HP-IL controller to turn the drive on or off remotely. This unique feature helps to extend system battery life and allows for system operation in remote applications.

Physical Specifications

17.8 x 13.2 x 6.1 cm (7" x 5.2" x 2.4")

Data Format

Number of tracks: 2 Density: 335 bits per cm (850 bits/inch)

Format: 256 bytes/record (8 bits/bytes)

Formatted capacity: 512 record (131,072 bytes)

HP 82162A Thermal Printer/Plotter

This HP-IL compatible printer/plotter provides numeric upper- and lowercase alpha, doublewide characters, and intensity control for optimum contrast and readability.

The chief enhancements of the HP 82162A over the HP 82143A dedicated Printer/Plotter are a 101-character buffer for enhanced graphics capabilities and a FORMAT function which automatically centers or justifies copy to the left and right margins.

The Printer/Plotter also supports STANDBY mode, so that any HP-IL controller on the loop can manage its power consumption.

Physical Specifications

17.8 x 13.2 x 6.1 cm (7" x 5.2" x 2.4")

Cable length: 86 cm (34 in)

Character Sets

96 standard ASCII

127 modified-expanded ASCII

HP 82905B Impact Printer

The HP 82905B Impact Printer is an 80-column, 9 x 9 dot-matrix printer which is compatible with HP-IL devices. The HP 82905B operates bidirectionally at 80 characters per second. In text mode, a logic-seeking feature finds the shortest route, permitting optimal printing throughout. The 9 x 9 dot-matrix character cells, together with the impact printing technique provide fast, legible character formation, including descenders (e.g., j,y,g, and q). Programmable line spacings, in increments of 1/72 inch, printing of superscripts and subscripts. A Roman character set allows printing in several languages.

The HP 82905B will print single or multipart forms (up to three parts, each with a maximum thickness of 0.3 mm). Its adjustable tractor feed mechanism can be used with all types of computer forms with widths between 10.2 cm (4 in.) in 25.5 cm (10 in.). Programmable page length allows the user to define page size and skip perforations.

HP 2671A/G Alphanumeric/Graphics Thermal Printers

The HP 2671A Alphanumeric Printer is both quiet and fast—120 characters per second with a smart, bidirectional print path. The 9 x 15 dot matrix provides excellent character definition. Highlight with an underlining feature, print standard English or use Roman Extension for multilingual text.

HP 2671G offers high-resolution graphics capabilities for charts, tables, illustrations, and graphs.

HP 7470A Graphics Plotter

The HP 7470A Graphics Plotter uses a two-pen system to produce high-quality color charts and graphs. It works with paper or overhead transparency film for professional presentations.

The Plotter will help spot trends and potential problems, compare results of several predictions, or focus on exceptions. Track information in relation to historical data or summarize for an overview. More than 40 HP-GL (Hewlett-Packard Graphics Language) instructions are built-in, letting you program the plotter with simple commands to perform a variety of complex operations, such as selecting pen velocity and defining characters. Text can be written in any direction, with or without slant, and in many sizes. Built-in symbol plotting and seven dashed-line fonts help clarify complex relationships.

Ordering Information

HP 82161A Digital Cassette Drive

HP 82162A Thermal Printer/Plotter

HP 82905B Opt 248, 348, 448 Impact Printer

HP 2671A Opt 048 Alphanumeric Thermal Printer

HP 2671G Opt 048 Graphics Thermal Printer

HP 7470A Opt 003 Graphics Plotter

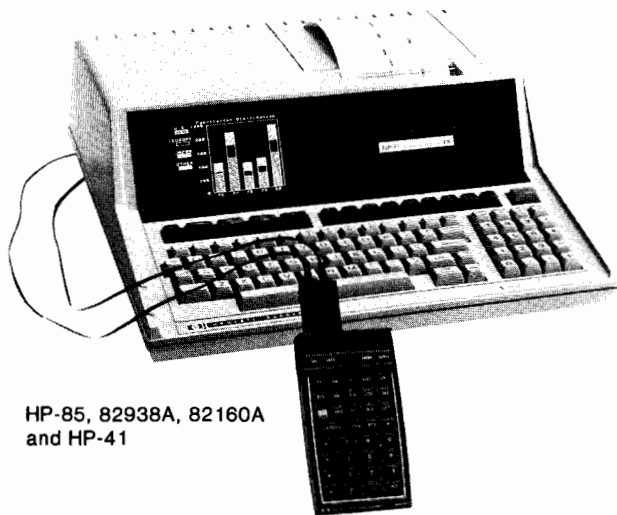
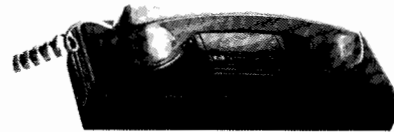
HP-85, 82938A, 82160A
and HP-41

82168A



82169A

**HP 82168A Acoustic Coupler (modem)**

The HP 82168A Acoustic Coupler is a telephone interface device that provides remote communications capabilities for Series 40 and Series 70 Computers through HP-IL. With the coupler, you have access to "dial-up" computer systems through a telephone line. Data transmission rate is 300 baud, and it works anywhere a conventional (G-type) receiver is available.

The Extended I/O Module, an HP-41 and the coupler are all that are necessary for Series 40 operation. The I/O Utilities Card (available in the HP-75C Solutions Book) is required for Series 70 operation. The Terminal Emulator program, available in the Acoustic Coupler Owner's Manual, is a convenient addition.

Physical Specifications

25.7 x 9.7 x 5.7 cm (10.1 x 3.8 x 2.2 in.)

HP-IL Video Interface

For information on video interface display capabilities for HP-IL mainframes, please contact an HP sales representative.

HP 82164A RS-232C Interface

Designed to allow interconnection of HP-IL systems with RS-232C devices, the HP 82164A HP-IL/RS-232C Interface translates HP-IL signals into RS-232 signals and vice versa. The interface provides bit-serial asynchronous data communication. Information can be sent and received (in true half- and full-duplex mode) in EIA RS-232C compatible voltage levels. This interface would most commonly be used to interface HP-IL mainframes to computers, terminals, peripherals, and modems. The HP 82164A interface comes packaged with one HP-IL cable and an ac adapter.

HP 82165A GPIO Interface Converter

The GPIO Interface allows HP-IL to control equipment operating with parallel bus structures. This device contains I/O buffering and a built-in power supply that operates from an HP standard ac adapter, (included with the HP 82165A). Potential applications for the HP 82165A include interfacing to computers for data collection, interfacing to specialized devices in production or lab environments, and interfacing to devices such as printers with parallel interfaces.

HP 82169A HP-IB Interface

The HP-IL/HP-IB Interface permits linkage of HP-IL systems with HP-IB (IEEE 488, 1978) computers and lab equipment. Its key feature is its friendly, flexible two-mode operation. In Translator mode, a controller and devices to be controlled may exist on one or both sides of the interface. In Mailbox mode, controller systems exist on both sides of the interface. The interface responds to most HP-IL and HP-IB commands. Power is supplied by the accompanying ac adapter.

HP 82938A HP-IL/Series 80 Interface

The HP 82938A Interface provides a communication link between the portable world of battery-operable products and the world of larger computers. Use a Series 40 or Series 70 computer to gather data in the field and then access an HP Series 80 personal computer to do more complex analyses. With the built-in graphics capabilities of an HP-85, HP-86 or HP-87 Personal Computer, data can be displayed in easy-to-understand graphs and charts, or passed on to an even larger computer using Series 80 data communication products.

HP 82166C HP-IL Interface Kit

The Interface Kit provides the necessary special components designed for incorporation into devices using the HP-IL interface. Three components are key to implementing the HP-IL interface standard: the HP-IL integrated circuit, the HP-IL transformer set, and the HP-IL panel receptacle. Included are complete component-level documentation, four complete sets of parts for prototype evaluation, and HP-IL development software for use on Series 40 and Series 70 computers.

Ordering Information

HP 82168A Acoustic Coupler (Modem)
HP 82164A RS-232 Interface
HP 82165A GPIO Interface
HP 82169A HP-IB Interface
HP 82938A Series 80 Interface
HP 82166C Interface Kit



Series 10/40/70 Accessories

A Hewlett-Packard calculator or computer purchase is a smart decision. Power, convenience, and quality from a company the user can depend on. But HP's computing products also have a versatility unequaled in the industry. There's a complete accessory line engineered to provide the support users need. No matter what type of Hewlett-Packard calculator/computer the user purchases, it is supported by a complete line of accessories and supplies to keep it operational. Such items as owner's manuals, programming pads, magnetic cards, thermal paper, battery packs, rechargers and software manuals are readily available.

HP Users' Library

The Users' Library is a resource of HP reviewed programs, written and submitted by users of Series 40 Handheld Computers, Series 70 Portable Computers, and HP-67/97 calculators. A wide variety of programs have been submitted for specific applications. Over 6,500 programs have been contributed, and each has been thoroughly reviewed by the Library's technical staff. Documentation includes pre-recorded magnetic cards, individual program listings and HP bar code (Series 40 only). Programs are also available on mini-cassette for use with the HP-IL Digital Cassette Drive. As a subscriber to the Library, members will receive the *Portable Computation Guide* with a complete list of programs, special discounts, free programs and special promotions.

Ordering Information

One-Year Subscription (U.S. and Canada)

One-Year Subscription (Outside U.S. and Canada)

HP-67/97 Programs (Includes complete documentation and magnetic cards)

HP-41C, HP-41CV Programs (Includes complete documentation, magnetic cards and bar code)

HP-75C Programs (Includes complete documentation)

HP 82176A Cassette Duplication Service
(Cassettes included)

Custom Products

HP Custom Products satisfy the growing need for specialization in portable computing products. Through customization, the powerful Series 40 Handheld Computers and Series 70 Portable Computers can be tailored to do complex and repetitious calculations or data acquisition tasks when and where needed. Proven Custom Products applications, in banking, fuel savings, media buying, sales and service, provide the same result: increased performance and improved productivity.

Using customer or third-party written programs, the HP-75 or the HP-41 can be customized using one of four options: Custom ROMs, Custom Magnetic Cards, bar code, and cassettes. When selecting one of these alternatives, consideration is given to: frequency of code alterations, desired program capacity, updating of variables in the data, required level of privacy and initial investment. Bar code is supplied by an HP-approved independent vendor.

HP 82500A or B HP-41 Custom ROM Modules

4K or 8K bytes of memory with each module. Nearly 21,000 program lines with up to four 8K modules.

HP 82720A, B, C, or D HP-75C Custom ROM Modules

8K, 16K, 24K or 32K bytes of memory with each module. Maximum three modules for 96K ROM capacity.

HP 82502A HP-41 Custom Magnetic Cards

HP 82722A HP-75 Custom Magnetic Cards

Cards used with the HP-41 and HP-67/97 can be customized to load up to 225 bytes; HP-75 cards hold 1.3K bytes per card.

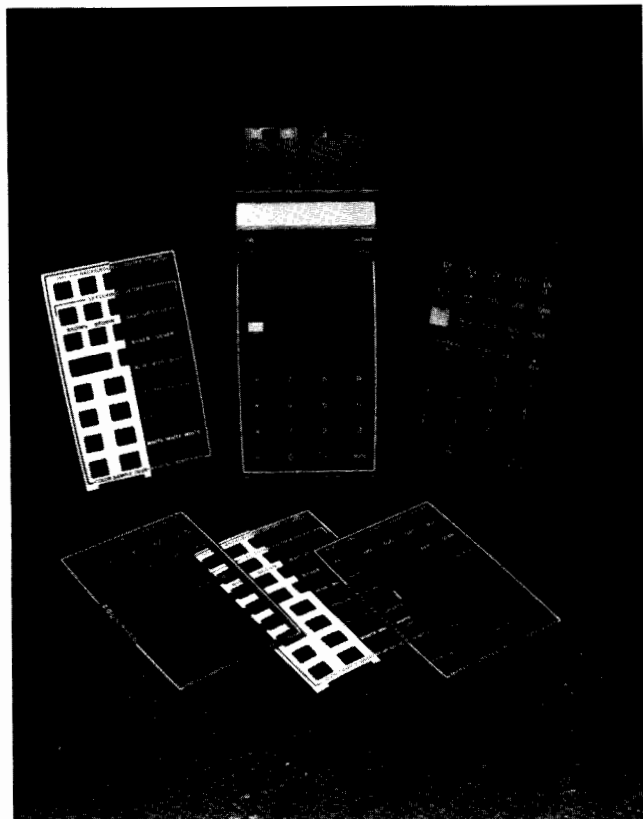

Custom Cassettes

Store several programs on one cassette. Load up to 128K bytes. The Users' Library offers a custom cassette duplication service.

Custom Keyboard Overlays and Custom Keyboard Touchpads

Re-label the HP-41 keyboard with special functions assigned to each key. Available in a variety of background and printing colors.

HP-41 Blank Keyboard Option

A custom HP-41C or HP-41CV Option 001 with a blank keyboard eliminates unnecessary and possibly distracting nomenclature. This special option allows the user to label those keys that precisely fit the application, minimizing potential user error. Custom Keyboard Overlays, (HP 82501A) and Custom Keyboard Touchpads, (HP 82504A), label keys to provide the final professional touch.

HP 82505 Software Development System

The HP 82505 Software Development System (SDS) allows development of plug-in ROM software on Series 40 Handheld Computers. The programs developed are converted to ROM image on the SDS. After field-testing and debugging is completed, copy the programs to a floppy disc. HP will manufacture ROM Modules from software contained on the disc.

HP 82713A Plug-In Module Simulator

The HP 82713A Plug-In Module Simulator (PMS) provides ROM simulation capability for a Series 70 Portable Computer. Store programs or files on the simulator on a permanent or temporary basis, or use it for software evaluations when developing a Custom ROM Module. A maximum of three simulators may be used at one time. A lithium battery ensures that the contents are retained when the simulator is unplugged.

For more information on the Custom Products Program, contact an HP sales representative.



COMPUTERS, PERIPHERALS & CALCULATORS

Personal Computation

Models HP-85B, HP-86B

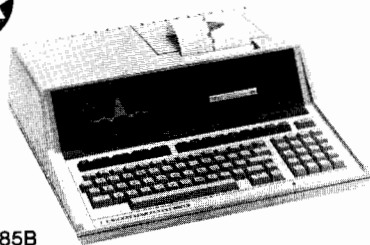

HP-85B



HP-86B

Why a Personal Computer?

As a working professional, you need the dedicated problem-solving power provided by HP's personal computers. The broad line of Series 80 personal computer products includes high-performance computers, peripherals, firmware, interfaces, and software, all designed to enhance your on-the-job performance.

Series 80

Hewlett-Packard's Series 80 personal computers are designed as office partners, to help you solve your problems in engineering, business, or science. The HP-85, HP-86, and HP-87 Personal Computers all feature enhanced HP BASIC (a superset of ANSI BASIC) with more than 150 commands and statements.

Enhancement ROM's (read-only memories) further expand programming capability by adding commands and functions to the computer, increasing the capabilities of existing commands, or allowing you to easily and quickly interface the computer with peripherals or instruments.

Electronic Disc, which conceptually acts as a high-speed disc drive, provides high-speed mass storage performance. It is a built-in feature of the HP-85B and HP-86B, and is available as a separate ROM for the HP-86A and HP-87XM.

HP-85B Personal Computer

The HP-85B Personal Computer combines an alphanumeric keyboard, CRT screen, thermal printer, tape drive, user read/write memory, and a ROM-based operating system in one portable package. There are 64K bytes of memory built into the HP-85B. Of this, 32K bytes are directly addressable as user-available read/write memory. The other 32K bytes, called Electronic Disc memory, are indirectly addressable via built-in mass storage commands. The 32K bytes of Electronic Disc are expandable to 544K bytes by using any combination of 64K or 128K plug-in memory modules. There's a 48K ROM operating system, 8K of display memory, and the capacity for six 8K ROM's via a ROM Drawer.

The typewriter-like keyboard includes eight user-definable keys which make it easier to write, execute, and control your programs.

The HP-85B's compact design lets you take computing power to your problems. You can use the built-in thermal printer to produce hard copy of your results. And, take along both data and software on tape cartridges that run on the built-in tape drive. In the office or lab, four I/O ports on the back of the HP-85B allow easy interfacing to peripherals and instruments.

HP-85B Specifications

User memory (bytes): 32K (standard), 32K (maximum).

Electronic Disc memory (bytes): 32K (standard), 544K (maximum).

Transfer rates (bytes/sec): 46,000 (Program LOAD, allocated); 17,000 (Program LOAD, deallocated); 13,000 (data file, maximum); 540 (data file, minimum).

CRT display area: 12.7 cm (5 in.) diagonal.

Display capacity: alphanumeric—16 lines x 32 characters; graphics—192 x 256 dots.

Thermal printer: 32-character width, 2 line/sec, bidirectional, adjustable intensity.

Magnetic tape cartridge: 210K bytes capacity, 42 separate files, search speed of 60 in./sec, read/write speed of 10 in./sec.

Power requirements: 90 to 127 Vac (115 Vac line), 200 to 254 Vac (230 Vac line), switch selectable, frequency of 50 to 60 Hz.

Size: 15 x 41.9 x 45.2 cm (6.3 x 16.5 x 17.8 in.).

HP-86B Personal Computer

The HP-86B gives you flexible configurations to meet your unique needs for computational power at competitive prices. You can choose one of two monitors, as well as various interfaces, expandable memory, a large selection of peripherals, optional operating systems, and lots of software.

Included are HP BASIC programming capabilities, a built-in CRT interface, and 16K of display memory. The keyboard has 14 user-definable keys that aid typing and let you select options within program execution. BASIC functions and statements build on those of the HP-85, with added functions that include string arrays, multi-character variable names, line labels, multi-parameter functions, multiple binary programs, formatted program listings, as well as graphics, printer, and mass storage commands.

The HP-86B gives you 128K bytes of built-in user memory that's expandable to 640K, and built-in Electronic Disc ROM and HP-IB Interface—plus optional local language keyboards at no extra cost.

Conceptually, Electronic Disc acts as a high-speed disc drive. Using the Electronic Disc ROM's capability, you can turn plug-in memory modules into an electronic mass storage medium. Two or more Electronic Discs can be created by assigning different volume labels. Disc space is electronically, rather than mechanically accessed, so execution speeds of software are greatly enhanced—without modification of your software. The Electronic Disc ROM also gives you access to HP's new 10M byte Winchester disc drives. At the end of a work session you'll want to back up the contents of Electronic Disc, because it resides in volatile RAM and is lost when the power is turned off.

NOTE: The Electronic Disc ROM is built into the HP-86B; it's available as a separate ROM for the HP-86A and HP-87XM.

Ten local language keyboards in addition to English are available with the HP-86B Personal Computer. You'll feel right at home immediately, because keyboard layouts match standard typewriter keyboards. Characters on the screen appear in the local language, and appropriate characters print out on your printer. All current HP printers support local character printing with the HP-86B.

HP-86B Specifications

User memory (bytes): 64K standard, 576K maximum (HP-86A); 128K standard, 640K maximum (HP-86B).

Electronic Disc Memory (bytes)

	HP-86A	HP-86B
Maximum user memory that can be allocated as Electronic Disc memory	32K	96K
Maximum add-on	384K	512K
Maximum total	416K	608K

Electronic Disc transfer rates (bytes/sec): 46,000 (Program LOAD, allocated); 17,000 (Program LOAD, deallocated); 13,000 (data file, maximum); 540 (data file, minimum).

Memory modules: HP 82908A 64K, HP 82909A 128K.

Size: 13 x 42 x 46 cm (5 x 16.5 x 17.8 in.).

Display capacity: alphanumeric—16 or 24 lines (variable) x 80 characters; graphics—400 or 544 x 240 dots (variable).

Power requirements: 90 to 127 Vac (115 Vac line), 200 to 254 Vac (230 Vac line), switch selectable. Frequency of 50 to 60 Hz.

COMPUTERS, PERIPHERALS & CALCULATORS

593

Personal Computation

Model HP-87XM, Series 80 Peripherals

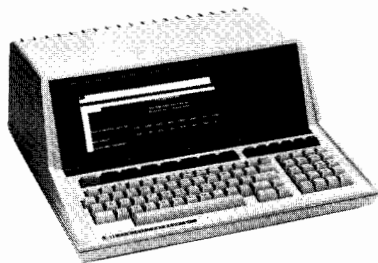

HP-87XM

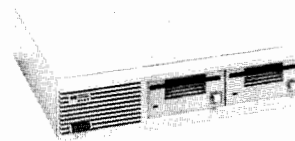

HP 9121D

HP 82912A/HP 82913A Monitors for the HP-86 Personal Computer

HP 82912A 9-inch Monitor Specifications

Display area: 16.5 x 11 cm (6.4 x 4.3 in.).

Power Requirements: 108 to 132 Vac (120 Vac line). Frequency of 60 Hz.

Power requirements (Opt. 001): 207 to 265 Vac (230 Vac line). Frequency of 50 to 60 Hz.

Size: 21.8 x 27 x 26.1 cm (8.5 x 10.5 x 10.2 in.).

HP 82913A 12-inch Monitor Specifications

Display area: 23 x 15 cm (9 x 5.8 in.).

Power requirements: 108 to 132 Vac (120 Vac line). Frequency of 60 Hz.

Power requirements (Opt. 001): 207 to 264 Vac (230 Vac line). Frequency of 50 to 60 Hz.

Size: 29.6 x 36 x 33 cm (11.5 x 14 x 12.8 in.).

HP-87XM Personal Computer

The HP-87XM is well suited for the technical or business professional who needs the compactness offered by an integrated high-resolution screen, extensive computing power, 128K bytes of user memory that's expandable to 640K, powerful programming functions, and HP-IB.

The HP-87XM features a 48K ROM operating system, 16K of display memory, and a built-in HP-IB interface that makes it easy to link your computer to up to 14 plotters, printers, disc drives, and instruments without taking up an expansion port.

The typewriter-like keyboard includes 14 user-definable keys that help you speed programming and identify branch routines during program execution. In addition, you can have the advantage of enhanced HP BASIC functions, including string arrays, multi-character variable names, line labels, multi-parameter functions, multiple binary programs, formatted program listings, and graphics, printer, and mass storage commands. Plus, you'll find that HP-85 BASIC programs will run on the HP-86 or HP-87 with little or no modification. HP-86 and HP-87 programs are compatible, except that graphics displays will require additional statements to be compatible, and binary programs will require some modification.

The 80-character-wide, high-resolution CRT screen gives you plenty of room to display programs, tables, or graphics. And, with a quick command, you can change the CRT display from 16 to 24 lines of characters.

HP-87XM Specifications

User memory: 128K bytes, expandable to 640K bytes, with the addition of HP memory modules.

CRT display area: 20.3 x 7.6 cm (7.9 x 3 in.) (10 in. diagonal).

Display capacity: alphanumeric—16 or 24 lines (variable) x 80 characters; graphics—400 or 544 x 240 dots (variable). Low-glare lens provides high contrast on screen.

Power requirements: 90 to 127 Vac (115 Vac line), 200 to 254 Vac (230 Vac line). Frequency of 50 to 60 Hz.

Size: 19.6 x 41.9 x 45.2 cm (7.7 x 16.5 x 17.8 in.).

System Expansion Capability

Memory Modules

You can increase the internal read/write memory of a Series 80 personal computer with optional memory modules that plug into the expansion ports on the back of the computer. If you have an HP-85A Personal Computer, use the HP 82903A 16K Memory Module to double user memory.

With the HP-86 and HP-87, you can use the HP 82908A 64K and HP 82909A 128K Memory Modules to increase your memory capacity.

And with the introduction of Electronic Disc, a new dimension has been added to the versatility of Series 80 memory modules. Electronic Disc memory, which is used as a high-speed mass storage medium, is easily expanded simply by inserting one or more 64K or 128K memory modules into an expansion port on the back of your HP-85B, HP-86, or HP-87 Personal Computer.

Series 80 Peripherals

Mass Storage Units

You can choose the mass storage unit that best fits your computing requirements when you need to increase the memory capacity of your Series 80 system, or gain high-speed transfer rates for your data.

The listing below outlines the mass storage units which can be used with Series 80 personal computers. For a detailed description of each, refer to Disc Drives, beginning on page 618.

Flexible disc systems: HP 9121D (dual), 3½"; HP 9121S (single), 3½"; HP 82901M (dual), 5¼"; HP 82902M (single), 5¼".

Combination disc system: HP 9133V (4.6M bytes), incorporating 3½" media.



COMPUTERS, PERIPHERALS & CALCULATORS

Personal Computation

Series 80 Peripherals (cont.)

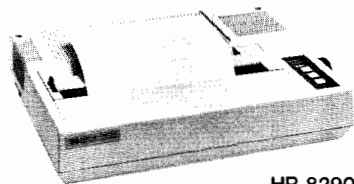

HP 82906A

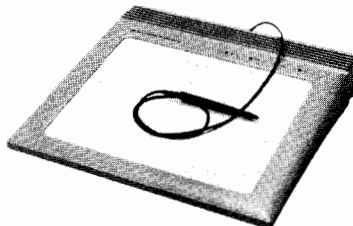
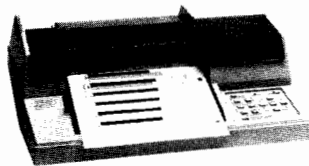

HP 9111A

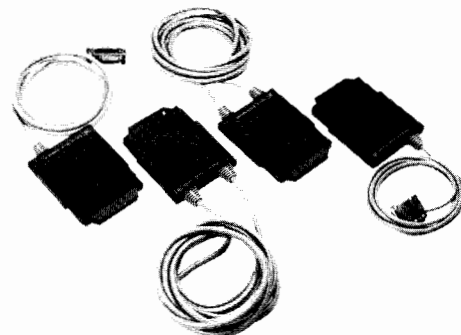

Series 80 Interfaces

Printer Options

The listing below outlines the printers which can be used with Series 80 personal computers. For a detailed description of each, refer to Printers, beginning on page 622.

General purpose: HP 82905B, printer; HP 82906A, printer; HP 2932A, printer; HP 2670 Series, thermal printers

Word processing: HP 2602A, Daisywheel; HP 2601A, Daisywheel

Graphics Options

The listing below outlines the graphics options which can be used with Series 80 personal computers. For a detailed description, refer to Graphics Plotters, beginning on page 627, and Graphics Tablet, beginning on page 634.

Graphics plotters: HP 7470A; HP 7475A; HP 9872T; HP 7580B; HP 7585B

Graphics tablet: HP 9111A

Ordering Information

HP-85B Personal Computer

HP-85B Interfacing Systems—all include HP-85B with built-in I/O ROM and the following interface:

HP-85B Interfacing System Opt. 001—female Serial Interface

HP-85B Interfacing System Opt. 002—male Serial Interface

HP-85B Interfacing System Opt. 003—current loop Serial Interface

HP-85B Interfacing System Opt. 004—GPIO Interface

HP-85B Interfacing System Opt. 005—BCD Interface

HP-85B Interfacing System Opt. 006—HP-IL Interface

HP-85B Interfacing System Opt. 007—HP-IB Interface

HP-86B Personal Computer

HP-86B Dual Disc System (includes HP-86B,

HP 9121D, and HP 82913A)

HP 82912A 9-inch monitor

HP 82913A 12-inch monitor

HP-87XM Personal Computer

HP 82908A 64K Memory Module

HP 82909A 128K Memory Module

HP 9121D 3½" Flexible Disc Drive

HP 9121S 3½" Flexible Disc Drive

HP 82901M 5¼" Flexible Disc Drive

HP 82902M 5¼" Flexible Disc Drive

HP 9133V 3½" Combination Disc Drive

HP 82905B Opt. 002 Printer

HP 82906A Opt. 002 Printer

HP 2932A Printer

HP 2671A Thermal Printer

HP 2671G Thermal Graphics Printer

HP 2673A Thermal Intelligent Graphics Printer

HP 2601A Daisywheel Printer

HP 2602A Daisywheel Printer

HP 7470A Opt. 002 Graphics Plotter

HP 7475A Opt. 002 Graphics Plotter

HP 9872T Opt. 085 Graphics Plotter

HP 7580B Graphics Plotter

HP 7585B Graphics Plotter

HP 9111A Opt. 085 Graphics Tablet (includes utility software for HP-85 only)

HP 9111A Opt. 086 Graphics Tablet (utility software can be purchased separately for HP-86 and HP-87)

Series 80 Interfaces

HP 82937A HP-IB Interface: implements the IEEE 488-1978 Standard Digital Interface for programmable instrumentation and is required for interfacing all HP-IB peripherals. It may communicate to as many as 14 HP-IB peripherals or compatible instruments per interface. (An HP-IB Interface is built into the HP-87 and HP-86B Personal Computers.)

HP 82938A HP-IL Interface: bit-serial interface that combines low power, small size, and low cost. With HP-IL you can interface as many as 30 devices with up to 10 meters of cable between each device.

HP 82169A HP-IL/HP-IB Interface: enables you to link HP-IL systems with HP-IB computers and lab equipment.

HP 82939A Serial Interface: provides RS-232C compatible I/O for communications with devices such as printers and terminals.

Standard HP 82939A: RS-232C female (DCE) connector.

Option 001: Serial Interface module with male connector for Series 80 computers; typically used with modems.

Option 002: Serial Interface module with current loop cable for Series 80 computers.

HP 82940A GPIO Interface: provides 16-bit general purpose input/output-operations.

HP 82941A BCD Interface: provides the hardware necessary for connection to devices having BCD (binary coded decimal) outputs.

HP 82966A Data Link Interface: offers you the ability to configure Series 80 personal computers with most other HP computer products on a common network.

HP 82949A Printer Interface: standard 8-bit Parallel Printer Interface module for connecting printers with a Centronics-type interface.

Series 80 ROM's

HP 82936A ROM Drawer: plugs into a Series 80 personal computer. The Drawer has slots for six 8K ROM's.

Mass Storage ROM (00085-15001): adds 30 operations that enable complete control and utilization of Series 80 mass storage units (for use with HP-85A only).

Plotter/Printer ROM (00085-15002): enables you to interface your HP-85 Personal Computer with Hewlett-Packard's graphics plotters and printers.

Plotter ROM (00087-15002): enables you to interface your HP-86/87 Personal Computer with Hewlett-Packard's graphics plotters. (Printer commands are built into the HP-86 and HP-87.)

I/O ROM (00085-15003 or 00087-15003): provides BASIC language extensions to Series 80 personal computers, allowing general I/O capability for a variety of interfaces and devices.

Matrix ROM (00085-15004 or 00087-15004): adds a powerful set of statements and functions to Series 80 personal computers for working with both matrices (two dimensional arrays) and vectors (one-dimensional arrays).

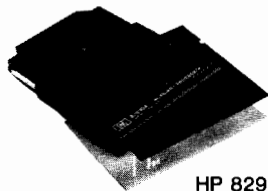

HP 82900A Opt. 001

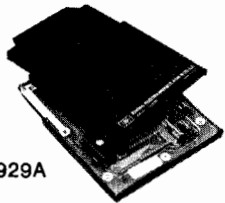

HP 82929A

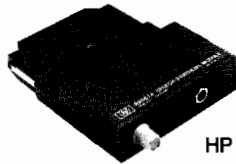

HP 82967A

Advanced Programming ROM (00085-15005 or 00087-15005): adds functions, statements, and commands to Series 80 personal computers that give you extended control over data, programs, and system operations.

MIKSAM ROM (00087-15011): is a powerful software development tool for applications programmers with which you can create and maintain a customized file management system on your HP-86 or HP-87.

Electronic Disc ROM (00087-15012): enables you to use RAM in the form of memory modules to emulate a flexible disc as high-performance mass storage on your HP-86A or HP-87 (Electronic Disc is built into the HP-86B).

Series 80 Programming Development Aids

Assembler ROM (00085-15007 or 00087-15007): lets you write customized Assembly language programs on Series 80 personal computers. These programs can be executed from random access memory or from programmable ROM's.

HP 82928A System Monitor: provides the necessary hardware to debug Assembly language software for Series 80 computers.

HP 82929A Opt. 001 Hybrid ROM Development System: lets you produce customized hybrid ROM's, in BASIC and Assembly language, on your HP-85 Personal Computer.

HP 82929A Programmable ROM Module: lets you use, in a Series 80 computer, EPROM's that you have created. In conjunction with the Assembler ROM and the System Monitor, this product completes a package designed to supply tools necessary to develop EPROM's for Series 80 computers.

Series 80 Communications

HP 82900A Opt. 001 (includes Auxiliary Processor module plus 3½" and 5¼" disc media), **HP 82849A Opt. 630** (includes 3½" disc media only), or **HP 82849A Opt. 650** (includes 5¼" disc media only)

TERM/80 Terminal Emulation System: gives you mainframe computer power plus the convenience of personal computing at your desk by turning your HP-86 or HP-87 into an intelligent terminal. Multiple operating modes are available, including block and format. By emulating the popular HP 2622A terminal, your computer provides a potential gateway to increased power and information. For example, when tied to an HP 3000 you can use VIEW/3000 to access data bases, enter information, and retrieve it. You can use mainframe computer power for complex operations and calculations. And you can do it at speeds from 110 to 9,600 baud. IBM 327X terminal emulation is available via the use of a third party protocol converter. Contact your local HP Sales Representative for details.

NOTE: If you have an HP 82900A CP/M System, you already own the Auxiliary Processor module. To acquire full TERM/80 capability, you need only order one of the HP 82849A options. See Ordering Information.

HP 82950A Modem: is a serial, asynchronous, full-duplex module that lets you and your Series 80 personal computer become part of nationwide computer networks. Use it to communicate with industrial data bases or commercial time-sharing systems such as Dow Jones News/Retrieval® service, THE SOURCESM, and CompuServe. The Modem is easy to use. Simply plug it into one of the expansion slots in the back of a Series 80 computer and connect it directly to your telephone. The HP 82950A Modem is compatible with Bell 103/113 modems and lets you communicate with the majority of time-sharing computers in the United States. It operates at speeds of 110 to 300 baud.

HP 82821A (Opt. 610, Opt. 630, or Opt. 650) Data Communications Pac: for hard-wired (RS-232C) data communications using an acoustic coupler, the Series 80 Data Communications software and HP 82939A Serial Interface combine to provide a variety of data communications configurations. You can use the Data Communications Pac when you need to send or receive information to or from another system at rates from 50 to 9,600 baud. The pac supports two handshaking options that let you turn your Series 80 personal computer into a remote character-mode terminal emulator.

HP 82967A Speech Synthesis Module: is a voice product that features high-quality human-sounding speech output at low cost. It will pleasantly surprise you with its voice quality, plug-in module package, and large vocabulary consisting of over 1,500 words, phrases, and sounds. It's easy to create, store, and produce speech with any Series 80 personal computer. The Module has two types of output jacks for configuration flexibility, and speaks through any standard 8-ohm speaker or headphone set. If used with an HP-86 and HP 82912A or HP 82913A monitor (which includes a built-in speaker), it is not necessary to acquire a speaker.

Optional Operating Systems

UCSD p-System (see product numbers and descriptions below): a complete software development system supporting UCSD Pascal, FORTRAN-77, and HP-86/87 Assembly language. The product is offered in various configurations supporting Pascal development, FORTRAN-77 development, or both. A separate configuration is also provided for application execute-only environments. Each configuration is offered in both 5¼" (Opt. 650) and 3½" (Opt. 630) disc media for use on an HP-86 or HP-87. When ordering HP part numbers below, it is necessary also to specify an option number (for appropriate disc media size).

HP 82825A UCSD p-System/FORTRAN-77: complete p-System software development system with FORTRAN-77 compiler.

HP 82826A UCSD p-System: software development system with Pascal compiler.

HP 82827A UCSD Pascal: add-on Pascal compiler to be used with HP 82825A.

HP 82828A FORTRAN-77: add-on FORTRAN-77 compiler to be used with HP 82826A.

HP 82829A UCSD p-System Runtime Module: lets you run software developed for the p-System. A subset of the configurations above. No software development utilities.

CP/M® system: opens a new world of software to you. The Auxiliary Processor module that's included contains all necessary hardware to implement the CP/M operating system. It extends your HP-86 or HP-87 system by adding a new CPU (Z-80A) and 64K bytes of RAM. Your HP-86 or HP-87 will accept software written under the CP/M Version 2.2 operating system that's compatible with HP disc format when loaded from disc.

HP 82900A (includes Auxiliary Processor module plus 3½" and 5¼" disc media), **HP 82848A Opt. 630** (includes 3½" disc media only), or **HP 82848A Opt. 650** (includes 5¼" disc media only).

NOTE: If you have an HP 82900A Opt. 001 TERM/80 Terminal Emulation System, you already own the Auxiliary Processor module. To acquire full CP/M System capability, you need only order an HP 82848A option. See Ordering Information.



COMPUTERS, PERIPHERALS & CALCULATORS

Personal Computation

Series 80 Software

Ordering Information

HP 82937A HP-IB Interface
HP 82938A HP-IL Interface
HP 82169A HP-IL/HP-IB Interface
HP 82939A Serial Interface (RS-232C), Female Connector
HP 82939A Opt. 001 Serial Interface (RS-232C), Male Connector
HP 82939A Opt. 002 Serial Interface, (RS-232C) Current Loop
HP 82940A GPIO Interface
HP 82941A BCD Interface
HP 82966A Data Link Interface
HP 82949A Parallel Printer Interface
HP 82936A ROM Drawer
00085-15001 HP-85A Mass Storage ROM
00085-15002 HP-85 Plotter/Printer ROM
00087-15002 HP-86/87 Plotter ROM
00085-15003 HP-85 Input/Output ROM
00087-15003 HP-86/87 Input/Output ROM
00085-15004 HP-85 Matrix ROM
00087-15004 HP-86/87 Matrix ROM
00085-15005 HP-85 Advanced Programming ROM
00087-15005 HP-86/87 Advanced Programming ROM
00087-15011 HP-86/87 MIKSAM ROM
00087-15012 HP-86/87 Electronic Disc ROM
00085-15007 HP-85 Assembler ROM
00087-15007 HP-86/87 Assembler ROM
HP 82928A System Monitor
HP 82929A Opt. 001 HP-85 Hybrid ROM Development System
HP 82929A Programmable ROM Module

NOTE: For the products below, media types and sizes are indicated by option number. Opt. 610 indicates software is provided on a tape cartridge (for HP-85 only), Opt. 630 indicates software is provided on a 3 1/2" flexible disc, and Opt. 650 indicates software is provided on a 5 1/4" flexible disc:

HP 82900A Opt. 001 HP-86/87 TERM/80 Terminal Emulation System (includes Auxiliary Processor plus 3 1/2" and 5 1/4" Disc Media)
HP 82849A Opt. 630 HP-86/87 TERM/80 Terminal Emulation System (software only)
HP 82849A Opt. 650 HP-86/87 TERM/80 Terminal Emulation System (software only)
HP 82950A Opt. 630 Series 80 Modem
HP 82950A Opt. 650 Series 80 Modem
HP 82821A Opt. 610 Series 80 Data Communications Pac
HP 82821A Opt. 630 Series 80 Data Communications Pac
HP 82821A Opt. 650 Series 80 Data Communications Pac
HP 82967A Series 80 Speech Synthesis Module
HP 82825A Opt. 630 HP-86/87 UCSD p-System/FORTRAN/77
HP 82825A Opt. 650 HP-86/87 UCSD p-System/FORTRAN/77
HP 82826A Opt. 630 HP-86/87 UCSD p-System Pascal
HP 82826A Opt. 650 HP-86/87 UCSD p-System Pascal
HP 82827A Opt. 630 HP-86/87 UCSD Pascal Compiler
HP 82827A Opt. 650 HP-86/87 UCSD Pascal Compiler
HP 82828A Opt. 630 HP-86/87 FORTRAN-77 Compiler
HP 82828A Opt. 650 HP-86/87 FORTRAN-77 Compiler
HP 82829A Opt. 630 HP-86/87 UCSD p-System Runtime Module
HP 82829A Opt. 650 HP-86/87 UCSD p-System Runtime Module

HP 82900A HP-86/87 CP/M System (includes Auxiliary Processor plus 3 1/2" and 5 1/4" Disc Media)
HP 82848A Opt. 630 HP-86/87 CP/M System (software only)
HP 82848A Opt. 650 HP-86/87 CP/M System (software only)

Series 80 Software

Series 80 offers a wide range of software packages, including HP-developed software, CP/M software for Series 80 personal computers, and user-proven software that you can purchase from your dealer, HP representative, or suppliers through the HP PLUS program.

Information below each description tells you what computer the software runs on, media types and sizes, HP part numbers, and any optional operating system you might need (CP/M or UCSD p-System).

CP/M®: indicates software that runs with the optional Series 80 CP/M system (available on the HP-86 and HP-87).

p-System: indicates software that runs with the optional UCSD p-System (available on the HP-86 and HP-87).

Media type: Opt. 610 indicates software is provided on a tape cartridge (for HP-85 only), Opt. 630 indicates software is provided on a 3 1/2" flexible disc, and Opt. 650 indicates software is provided on a 5 1/4" flexible disc.

Software Descriptions and Ordering Information

Spreadsheet Analysis

VisiCalc® PLUS: this powerful analytical tool gives you the capability to prepare a five-year forecast with over 200 line items—on a worksheet with up to 63 columns and 254 rows. And, you get the Series 80 PLUS: graphics and financial analysis capabilities built into VisiCalc.

HP-85	HP 82800A Opt. 610
HP-85	HP 82800A Opt. 630
HP-85	HP 82800A Opt. 650
HP-86/87	HP 82830A Opt. 630
HP-86/87	HP 82830A Opt. 650

Graphics

Graphics Presentations: lets you create graphics on paper for reports and analysis, or on transparencies for overhead presentations.

HP-85	HP 82801A Opt. 610
HP-85	HP 82801A Opt. 630
HP-85	HP 82801A Opt. 650
HP-86/87	HP 82831A Opt. 630
HP-86/87	HP 82831A Opt. 650

Word Processing

WORD/80: for preparing reports, letters, and other "typewritten" documents. Softkeys are used so you can easily edit, format, print, or store your document by pressing a few keys.

HP-86/87	HP 82823A Opt. 630
HP-86/87	HP 82823A Opt. 650

WordStar®: is a powerful program that provides aids for editing, reorganizing, and formatting printed documents.

HP-86/87	HP 45584A Opt. 630 CP/M
HP-86/87	HP 45584A Opt. 650 CP/M

SpellStar™: uses a dictionary of approximately 20,000 words to check WordStar files for spelling and typographical errors.

HP-86/87	HP 45588A Opt. 630 CP/M
HP-86/87	HP 45588A Opt. 650 CP/M

MailMerge™: adds to the printing capabilities of WordStar. Merges files or a mailing list into a form letter file.

HP-86/87	HP 45587A Opt. 630 CP/M
HP-86/87	HP 45587A Opt. 650 CP/M

Text Editing: enables you to write memos, outlines, and reports on your display screen, and edit copy by changing words or moving groups of lines.

HP-85	HP 82816A Opt. 610
HP-85	HP 82816A Opt. 630
HP-85	HP 82816A Opt. 650

UCSD p-System and UCSD Pascal are trademarks of the Regents of the University of California.

CP/M® is a trademark of Digital Research, Inc.

VisiCalc® is a registered trademark of VisiCorp.

WordStar® and MailMerge™ are registered trademarks of MicroPro International Corporation.

SpellStar™ is a trademark of MicroPro International Corporation.



Data Management

FILE/80: this user-friendly file management system makes it easy to create files and generate reports from them. An on-screen form lets you prepare labels, reports, and form letters with names or other information inserted from your files. Extensive search capabilities are also provided.

HP-86/87 HP 82824A Opt. 630
 HP-86/87 HP 82824A Opt. 650

Personal Productivity Pac: combines the VisiCalc®, WORD/80, and FILE/80 software packages.

dBASE II™: lets you create interrelated files and enter and retrieve information. You can design your data base to work interactively or under the control of programs that you write using English-like commands.

HP-86/87 HP 45583A Opt. 630 CP/M
 HP-86/87 HP 45583A Opt. 650 CP/M

File Manager: lets you search up to 1,000 records using up to ten conditions. Aids record-keeping with five-level nested sort capability, and built-in report and graphics programs.

HP-85 HP 88103A Opt. 630
 HP-85 HP 88103A Opt. 650

HP-86/87 HP 88104A Opt. 630
 HP-86/87 HP 88104A Opt. 650

Information Management Pac (IMPac): lets your HP-85 handle list management by creating data files, searching records and generating lists and reports.

HP-85 HP 82817A Opt. 630
 HP-85 HP 82817A Opt. 650

Time and Project Management

Milestone®: lets you do instant *what-if* analyses to update schedules, observe the impact of scheduling changes, and analyze your costs to show the tradeoffs between labor, expenses, and time.

HP-86/87 HP 45580A Opt. 630 CP/M
 HP-86/87 HP 45580A Opt. 650 CP/M

Datebook II™: this is an appointment-scheduling program for doctors, attorneys, and other professionals. It maintains up to 40 appointments per day for as many as 27 people.

HP-86/87 HP 45581A Opt. 630 CP/M
 HP-86/87 HP 45581A Opt. 650 CP/M

Personal Datebook™: applies the speed and efficiency of Datebook II to your individual time-scheduling problems.

HP-86/87 HP 45582A Opt. 630 CP/M
 HP-86/87 HP 45582A Opt. 650 CP/M

Real Estate

Real Estate Asset Management (Berge Software)

Investment Analysis: is a complete commercial property analysis system which enables you to quickly evaluate investment opportunities and alternatives.

HP-86/87 HP 82871A Opt. 630
 HP-86/87 HP 82871A Opt. 650

Commercial Finance: is a system of programs that interacts with Investment Analysis; it's designed to give you immediate solutions to the analysis of commercial financing.

HP-86/87 HP 82874A Opt. 630
 HP-86/87 HP 82874A Opt. 650

Land and Lease Analysis: assists you in analyzing the holding and disposition of raw land, and in analyzing various leasehold situations.

HP-86/87 HP 82873A Opt. 630
 HP-86/87 HP 82873A Opt. 650

Residential Finance: provides immediate analyses of residential financing instruments.

HP-86/87 HP 82875A Opt. 630
 HP-86/87 HP 82875A Opt. 650

Acquisition and Disposition Analysis: is designed to help you analyze the acquisition and disposition of income-producing properties, including tax-deferred exchange and installment sales.

HP-86/87 HP 82872A Opt. 630
 HP-86/87 HP 82872A Opt. 650

Accounting

Peachtree Accounting Series 8

You can use these five accounting modules individually or together

dBase II™ is a trademark of Ashton-Tate.

Milestone® is a registered trademark of Organic Software, Inc.;

Datebook II™ and Personal Datebook are trademarks of Organic Software, Inc.

to form an integrated accounting system that can combine the entries in all modules for trial balancing and end-of-period reporting.

General Ledger: helps you track a company with up to 100 departments. This module provides a complete set of management reports and can automatically post transactions you've recorded in other Peachtree modules.

HP-86/87 HP 82883A Opt. 630
 HP-86/87 HP 82883A Opt. 650

PeachPay™ Payroll System: is a complete employee payroll system that you can use by itself or with General Ledger.

HP-86/87 HP 82887A Opt. 630
 HP-86/87 HP 82887A Opt. 650

Accounts Receivable: is designed to help you prepare bills and obtain timely collections from your customers.

HP-86/87 HP 82884A Opt. 630
 HP-86/87 HP 82884A Opt. 650

Accounts Payable: maintains a complete master file for each of your vendors, and shows you which invoices to pay.

HP-86/87 HP 82885A Opt. 630
 HP-86/87 HP 82885A Opt. 650

Inventory Control: helps you exercise control over all facets of your inventory operations.

HP-86/87 HP 82886A Opt. 630
 HP-86/87 HP 82886A Opt. 650

TAJ™ I-85 The Accounts Journal™: fully integrates the journals needed in small business accounting.

HP-85 HP 82854A Opt. 650

Finance

Aardvark Tax Planning

Includes four programs, all fully tested by a major public accounting firm.

Personal Tax Plan: lets individual users do year-end planning using *what-if* calculations to minimize federal tax liabilities.

HP-86/87 HP 45586A Opt. 630 CP/M
 HP-86/87 HP 45586A Opt. 650 CP/M
 HP-86/87 HP 82877A Opt. 630 p-System
 HP-86/87 HP 82877A Opt. 650 p-System

Professional Tax Plan: for professionals who provide tax consulting to clients. Includes the capabilities of Personal Tax Plan, plus indexing for tax years 1985 and thereafter, and ten-year averaging.

HP-86/87 HP 45585A Opt. 630 CP/M
 HP-86/87 HP 45585A Opt. 650 CP/M
 HP-86/87 HP 82876A Opt. 630 p-System
 HP-86/87 HP 82876A Opt. 650 p-System

ESTATE TAX PLAN:** for trust officers and professionals who manage estates. Helps you determine various planning factors that affect death tax liabilities and payment schedules.

HP-86/87 HP 82878A Opt. 630 p-System
 HP-86/87 HP 82878A Opt. 650 p-System

Fixed Asset Accounting: for businesses, accountants and tax preparers. Handles the tedious and time-consuming aspects of fixed asset management.

HP-86/87 HP 82879A Opt. 630 p-System
 HP-86/87 HP 82879A Opt. 650 p-System

Portfolio Management: helps individual investors and professional investment advisors monitor their portfolios.

HP-85 HP 82814A Opt. 630
 HP-85 HP 82814A Opt. 650
 HP-86/87 HP 82844A Opt. 630
 HP-86/87 HP 82844A Opt. 650

Financial Decisions: provides programs for a variety of financial analyses.

HP-85 HP 82803A Opt. 610
 HP-85 HP 82803A Opt. 630
 HP-85 HP 82803A Opt. 650
 HP-86/87 HP 82833A Opt. 630
 HP-86/87 HP 82833A Opt. 650

PeachPay™ is a trademark of Peachtree Software, Inc.

TAJ™ and The Accounts Journal™ are trademarks of Production Data Systems.

**ESTATE TAX PLAN was developed under the supervision of Dr. William A. Raabe, CPA.

Engineering and Science

Waveform Analysis: offers a wide range of applications in digital signal processing.

HP-85	HP 82809A Opt. 610
HP-85	HP 82809A Opt. 630
HP-85	HP 82809A Opt. 650
HP-86/87	HP 82839A Opt. 630
HP-86/87	HP 82839A Opt. 650

AC Circuit Analysis: lets you quickly and easily simulate AC circuits and analyze their performance so you can recognize design problems early in the development process.

HP-85	HP 82810A Opt. 610
HP-85	HP 82810A Opt. 630
HP-85	HP 82810A Opt. 650
HP-86/87	HP 82840A Opt. 630
HP-86/87	HP 82840A Opt. 650

Math: provides quick access to mathematical routines commonly employed in calculus, numerical analysis, linear systems, geometry, and special functions.

HP-85	HP 82811A Opt. 610
HP-85	HP 82811A Opt. 630
HP-85	HP 82811A Opt. 650
HP-86/87	HP 82841A Opt. 630
HP-86/87	HP 82841A Opt. 650

Electronics Engineering Multi Pac: combines the AC Circuit, Waveform Analysis, and Math software packages.

HP-85	HP 82812A Opt. 610
HP-85	HP 82812A Opt. 630
HP-85	HP 82812A Opt. 650
HP-86/87	HP 82842A Opt. 630
HP-86/87	HP 82842A Opt. 650

Surveying: helps you calculate and reduce field data in field traversing. Stores, adjusts, and transforms coordinates. Offers curve solutions, resections, intersections, earthwork, and triangle solutions.

HP-85	HP 82813A Opt. 610
HP-85	HP 82813A Opt. 630
HP-85	HP 82813A Opt. 650
HP-86/87	HP 82843A Opt. 630
HP-86/87	HP 82843A Opt. 650

Computation and Analysis

General Statistics: offers widely-used statistical tools for one-sample analysis, chi-square, one- and two-way analysis of variance, t-test, and multiple linear regression.

HP-85	HP 82804A Opt. 610
HP-85	HP 82804A Opt. 630
HP-85	HP 82804A Opt. 650
HP-86/87	HP 82834A Opt. 630
HP-86/87	HP 82834A Opt. 650

Basic Statistics and Data Manipulation: prepares your data for analysis and computes such summary statistics as mean, standard deviation, number of observations, median, confidence interval, and quartiles.

HP-85	HP 82805A Opt. 610
HP-85	HP 82805A Opt. 630
HP-85	HP 82805A Opt. 650
HP-86/87	HP 82835A Opt. 630
HP-86/87	HP 82835A Opt. 650

Regression Analysis: analyzes relationships between a dependent variable and one or more independent variables. (Requires the Basic Statistics and Data Manipulation Pac.)

HP-85	HP 82806A Opt. 610
HP-85	HP 82806A Opt. 630
HP-85	HP 82806A Opt. 650
HP-86/87	HP 82836A Opt. 630
HP-86/87	HP 82836A Opt. 650

Statistical Analysis Multi Pac: gives you a complete, integrated software package for performing statistical analysis. Combines the Gen-

eral Statistics, Basic Statistics and Data Manipulation, and Regression Analysis pacs.

HP-85	HP 82807A Opt. 610
HP-85	HP 82807A Opt. 630
HP-85	HP 82807A Opt. 650
HP-86/87	HP 82837A Opt. 630
HP-86/87	HP 82837A Opt. 650

Linear Programming: gives you a simple and convenient means of optimizing linear programming modes. Fits applications such as production scheduling, pharmaceuticals, food processing, feed lot blending, media selection, and more.

HP-85	HP 82808A Opt. 610
HP-85	HP 82808A Opt. 630
HP-85	HP 82808A Opt. 650
HP-86/87	HP 82838A Opt. 630
HP-86/87	HP 82838A Opt. 650

Education

BASIC Training: provides a self-teaching tutorial course on the operation and BASIC programming of Series 80 personal computers.

HP-85	HP 82802A Opt. 610
HP-85	HP 82802A Opt. 630
HP-85	HP 82802A Opt. 650
HP-86/87	HP 82832A Opt. 630
HP-86/87	HP 82832A Opt. 650

Recreational

Games and Games II: two games pacs include card games, board games, dynamic action games, and games of pattern generation.

Games

HP-85	HP 82818A Opt. 610
HP-85	HP 82818A Opt. 630
HP-85	HP 82818A Opt. 650

Games II

HP-85	HP 82819A Opt. 610
HP-85	HP 82819A Opt. 630
HP-85	HP 82819A Opt. 650

Additional Solutions

In addition to the software pacs listed above, third-party software solutions exist for such applications as:

- Real Estate Analysis
- Hydrology
- Optical Design
- Tax Planning
- Structural Engineering
- Design & Mapping
- Medical & Dental
- Topography
- Chemical Engineering

Series 80 Users' Library: contains over 400 programs written by owners of Series 80 personal computers. These programs cover applications ranging from business and finance to the physical sciences. For more information on purchasing or contributing programs, see the Series 80 Software Catalog (available from your HP dealer or sales representative, major bookstores and computer retail outlets).

Series 80 Solution Books

These books, which can be ordered from dealers or HP Sales Representatives, provide you with ready-to-use programs. You need only type them into your computer and they're ready to run. Each of the 16 books contains from nine to twelve programs in one of these application areas—Business, Engineering, Science, Education, and Recreation. Programs are also available on software media (tape, or 3½" or 5¼" disc), which you can order directly from the Users' Library.

Business

- Stocks & Bonds
- Securities & Investment Analysis
- Budgeting & Finance I
- Budgeting & Finance II
- Management Science
- Real Estate

Scientific Series

- Math
- Numerical Analysis
- General Probability
- Decision Analysis

Series 80 Solution Books

Educational Series

- Math Learning
- Science Learning I
- Science Learning II
- Electrical Engineering Learning

Recreational Series

- Games

Engineering Series

- Electrical Engineering

Series 100 Personal Office Computer Systems

Series 100 Personal Office Computers offer complete business solutions in a choice of two packaging styles. The HP 120 is a compact personal computer with minimal desk-space requirements. The entire system (display, computer, keyboard and 3.5-inch disc drives) occupies only 1.7 square feet of space, about the same footprint as an open looseleaf notebook. The HP125B includes a full-sized 12-inch display. The two products use the same operating system, the same broad range of software, and can be configured with comparable peripherals.

Computer Features

System Architecture

Series 100 computers have dual Z-80A microprocessors which communicate through a high-speed "mailbox" to pass data and commands. One microprocessor controls terminal functions and I/O activities such as the keyboard, display, and serial data communications. The other microprocessor is dedicated to processing operating system commands and controlling HP-IB devices, such as disc drives. The standard system includes a full 64K bytes of RAM for operating system, applications, and user workspace. Additional RAM supports up to five pages of display memory.

CP/M® Operating System

The Series 100 computers use the CP/M (version 2.2) operating system which resides on disc. On initialization, ROM-based instructions load the operating system from the disc into the processor's main memory. CP/M is a single-user, single-task operating system for which many third-party software packages have been developed.

Display

Both the HP 120 and HP 125B display 1,920 characters in a 24-line by 80-column format. The HP 120 utilizes a 9-inch diagonal display screen, while the 125B has a 12-inch screen. The 25th and 26th lines on each system are used for the screen labeling of function keys or as message/status lines. The screen memory stores five pages of text, which allows off-screen display storage. High-resolution characters with true descenders are generated in a 9x15 dot cell with half-dot shift.

Keyboard Features

The detached, typewriter-like keyboard is designed to provide a friendly and familiar interface to the system and minimize training time. Sculptured keycaps and dished "home" keys help to make the keyboard comfortable to use. Special keys include cursor control, display scrolling keys, and "next page" and "previous page" keys. In addition, a set of "delete" and "insert" keys are standard.

Special Function Keys

Eight screen-labeled function keys allow quick access to configuration, self-test, printer control, and other functions. The keys also offer a new level of operator/application program interface by allowing the program to



redefine and relabel the keys as needed. A software program can use the screen labeled keys to guide a user step by step through an application.

Data Communications

By pressing the REMOTE MODE a user changes the Series 100 computer from a standalone computer system to an interactive computer terminal. Either of two RS232C communications channels can connect the system to a remote computer. Flexible handshaking using hardware lines or control characters allows connection to a wide range of computers and printers. In addition to standard RS232C interfaces, the HP 125B can support the 13266A 20 mA Current Loop Interface or the 13265A 300 Baud Modem.

Block/Format Mode

The Block/Format software utility allows Series 100 computers to operate as block mode terminals with applications using V/3000 software for data entry. Using a formatted screen with protected and unprotected fields, data may be entered and edited on the display screen. When complete, the data is transmitted as a continuous block of data.

Reliability and Serviceability

The Series 100 Personal Office Computers have been engineered for high reliability and fast repair when needed. A "Power On Test" provides a complete test of both the processor

and terminal functions. Additional tests can be initiated by the user to test the integral printer and the data communications channels. The built-in self-test capabilities provide the user with a GO/NO GO indication.

System

- 45500B** HP 125 Personal Office Computer
(includes 1 Meter HP-IB cable)
- 45600A** HP 120 Personal Office Computer
(includes 0.3 Meter HP-IB cable)
- Options for both systems
- 630** Operating System on 3.5" Micro-Disc
- 650** Operating System on 5.25" Mini-Disc
Note: An Operating System option must be specified
- 301** U.S. Data Communications Cable
- 302** European Data Communications Cable
HP 120 Options Only
- 304** Direct Connect Cable to HP 3000 Series 64
- 308** 1 Meter HP-IB cable (45529A)
HP 125 Options Only

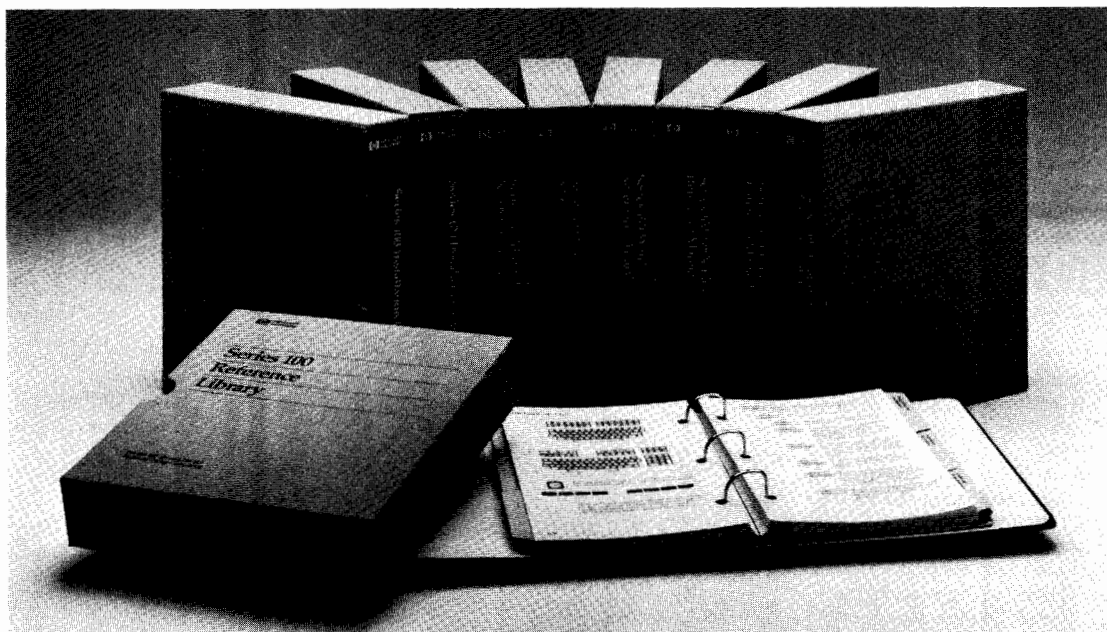

Series 100 Software

Series 100 Software was designed specifically for non-computer business professionals, managers, and administrative support personnel who want pushbutton ease-of-use plus powerful business and communications functionality.

Series 100/Visicalc®: electronic spreadsheet capability with up to 63 columns and 254 rows. Allows easy entry and revision of numbers plus "what if" analysis.

45531B

Series 100/Graphics: creates multicolor pie charts, bar charts, line graphs, and text slides when used with HP plotters.

45532B

Series 100/Word: full feature word processor for entering and editing text on the CRT and formatting text for letter quality printing. Includes mailing list capability.

45533B

Series 100/DSN/LINK: provides file transfer capability between Series 100 personal computers and HP 3000 computers. Includes error checking with automatic retransmission.

45534B

Series 100/BASIC: full feature BASIC interpreter

45535A

Series 100/Programming Package: provides utilities for assembly language programming for CP/M operating system. Includes reference manual.

45536A

Series 100/Condor 20-1: database software for managing information. Allows easy entry and editing of information and ability to sort information and generate reports.

45550A

Series 100/Condor 20-2: increases power beyond Condor 20-1 by allowing merging of databases for a true relational database capability.

45550E

Series 100/Condor 20-3: increases power of Condor 20-2 by adding report writing capabilities.

45550H

Series 100/Condor 20-1 to 20-2 Upgrade Kit

45550K

Series 100/Condor 20-2 to 20-3 Upgrade Kit

45550N

Series 100/Condor 20-1 to 20-3 Upgrade Kit

45550P

Series 100/BPI General Accounting: fully integrated accounting software for small businesses. Includes general ledger, accounts receivable, accounts payable, and payroll.

45552A

Series 100/BPI Payroll: separate payroll accounting software that operates independently or in conjunction with BPI General Accounting.

45553A

WordStar®/100: powerful word processing software for entering and editing text on the CRT plus formatting capabilities for output to letter quality printers.

45560A

SpellStar®/100: uses a 20,000 word dictionary to check WordStar files for spelling and typographical errors.

45561A

MailMerge®/100: adds mailing list capabilities when used with WordStar.

45562A

Series 100/MicroPlan®: financial planning software that includes financial functions, data entry capability, and programming functions.

45670A

MicroPlan Consolidation: adds capability to consolidate worksheets when used with MicroPlan software.

45671A

Milestone®: project management software for scheduling and tracking up to 126 related events.

45580A

Datebook II®: manages office calendars used to schedule people, rooms, and equipment. Allows up to 27 concurrent schedules.

45581A

dBASE II®: relational database management system allows user to define input screens, store data, and produce reports.

45583A

Personal Datebook®: personal calendar software to keep track of appointments and reminders. Allows up to nine concurrent schedules.

45582A

Aardvark Professional Tax Plan: for use by professional planners; allows 5 year planning horizon and comparison of investment alternatives. Requires working knowledge of tax law.

45585A

Aardvark Personal Tax Plan: for use by individuals; allows 5 year planning horizon and comparison of investment alternatives. Requires some knowledge of tax law.

45586A

Note: all orders for the 45500B, 45600A and each software product must include a media option to specify media size:

Option	Media
630	3.5" disc
650	5.25" disc
680	8" disc

Visicalc® is a registered trademark of VisiCorp.
CP/M® is a registered trademark of Digital Research, Inc.
WordStar® is a registered trademark of MicroPro International Corp.
SpellStar® and MailMerge® are trademarks of MicroPro International Corp.
MicroPlan® is a trademark of Chang Laboratories, Inc.
Milestone®, Datebook II®, and Personal Datebook® are trademarks of Organic Software.
dBASE II® is a trademark of Ashton-Tate.

COMPUTERS, PERIPHERALS & CALCULATORS

Business Oriented Computer Systems

HP3000, HP250

601



HP 3000, Series 68

HP 3000 Business Computer

The HP 3000s are a compatible family of business computer systems for distributed data processing. All models share the same multiprogramming executive operating system (MPE) featuring virtual memory, the same high-level languages, and are able to run one another's programs interchangeably. Full-function general-purpose capabilities include simultaneous transaction-processing, data communication, on-line program development, and batch operations in COBOL, RPG, BASIC, FORTRAN, PASCAL and SPL (the HP system programming language). Most powerful and capable of greatest expansion is the HP 3000 Series 68, with main memory of 8 Mb and the ability to support up to 400 terminals, each running or developing separate programs. The Series 42 and 48 systems offer somewhat less performance at less cost. The entry level Series 39 provides a very cost-effective solution for up to 92 terminals and 3 Mb of memory. Where greater expandability is required, the Series 48 can provide a system of up to 152 terminals and 4 Mb of memory. All models are fully upgradable to the Series 68. The HP 3000s provide a complete data base management and inquiry facility, IMAGE/ QUERY, as well as a data entry/forms generation system, VPLUS/3000. In addition, all may be interconnected via an HP Distributed Systems Network that can also integrate HP 3000s with HP 1000 networks and the HP 9800 family of desktop computers, as well as IBM mainframes.



HP 250

HP 250 Business Computer

The HP 250 is designed to meet the business management needs of small companies and departments of larger ones.

A standard system contains 64 Kb of user memory, 192 Kb of system memory, and either a 16.5 Mb, 28.1 Mb, or 65.6 Mb disc drive with tape cartridge for back-up. Available on the HP 250 are applications packages for finance, manufacturing, order management, text processing, decision support graphics, and two synchronous data communications packages.

The HP 250 is able to support up to 10 workstations. For distributed applications, it can communicate with larger computers either asynchronously or synchronously.

Office Systems Tools

Several important software packages are available for the HP 3000 which make it especially productive in an interactive office environment. These office systems products bring the information processing and communications capabilities of the HP 3000 directly to business professionals and support personnel in the office.

HPWORD sets new standards for ease of use in word processing.

HPMAIL is an electronic mail system for internal communications throughout a company.

INFORM/3000 helps business professionals produce ad hoc reports in minutes.

DSG/3000 is a sophisticated interactive system for creating charts, graphs, statistics, production plans, and other graphic output.

HPEASYCHART is a simple tool for producing pie charts, bar charts, and line graphs.

HPDRAW is used to design and produce high quality presentation aids.

Application Software Solutions

Hewlett Packard offers applications software for manufacturers which runs on the HP 3000 computer. These application software products include Materials Management/3000, Production Management/3000, Financial Accounting, SFD/3000, and Semiconductor Productivity Network software.

Materials Management/3000 is an interactive application system for managing the materials planning and control function of a manufacturing operation.

Production Management/3000 is an interactive application system for managing manufacturing production planning and control.

Financial Accounting is an interactive financial application software system which is equally beneficial for manufacturers and other types of businesses.

SFD/3000 is an integrated application system designed to meet an organization's needs for inventory distribution control and order processing.

Semiconductor Productivity Network is a comprehensive system for integrated circuit manufacturers.





COMPUTERS, PERIPHERALS & CALCULATORS

Technical Computers

Models 9816A/S, 9920A, 9826A/S, 9836A/C/S/CS, 9845B/C



Series 200 Models 16, 20, 26, and 36 Technical Computers

Hewlett-Packard's Series 200 technical computers include Models 16, 20, 26, 36, and 36C (ordered as Models 9816, 9920, 9826, and 9836). They are based on the Motorola MC68000 16-bit microprocessor, with 32-bit internal architecture.

These computers are powerful standalone units, or instrument system controllers for laboratory automation or production test. With peripherals, they also perform as technical workstations in computer-aided engineering (CAE) design and test applications.

The Series 200 Model 16 has a 9-inch (229 mm) CRT, a detached keyboard, and memory from 128Kb to 768Kb. External printers, disc drives, and other peripherals can configure it as a standalone workstation; or it can be connected to a Shared Resource Management (SRM) system with other HP computers, sharing printers and disc drives. HP-IB* and RS-232-C interfaces are built in.

The Model 20 is a modular, rack-mountable computer with a separately available keyboard, monitor, disc drive, and an assortment of peripherals. With extra interface and memory slots, plus the capability to remove the keyboard and monitor, the Model 20 is well suited for production test applications on the factory floor.

The Model 26 features a 7-inch (178 mm) CRT, a built-in 5-1/4 inch flexible disc drive with 264Kb capacity, and up to 2Mb of memory. With a larger base and keyboard than the Model 16, it can be placed in a rack with other electronic devices and instrumentation. With built-in HP-IB interface, it is ideal for CAT applications, where a more integrated system is required.

The Model 36 features a full 12-inch (310 mm) CRT, two built-in 5-1/4 inch flexible disc drives, and up to 2Mb of memory. Its larger screen and mass storage capacity (528Kb) tailor it for CAE applications such as engineering design and analysis. It has a built-in HP-IB interface.

The Model 36C is the top computer in the Series 200 line, with a 12-inch (310 mm) color CRT, dual built-in 5-1/4 inch flexible drives, and up to 2Mb of memory. This is an ideal machine for CAE applications, where color provides enhanced graphics capability.

The Series 200 machines feature BASIC, Pascal and HPL languages, graphics, user-definable softkeys, a special "rotary control knob" for easy editing and simulations, memory-mapped I/O, prioritized interrupt, internal system clock and timers, and built-in slots for additional memory or interface cards. A special backplane expander allows adding up to 7.4Mb of memory or eight interface cards to any Series 200 computer.

RAM-based and ROM-based BASIC, HPL, and Pascal languages are orderable separately for the Models 16A, 26A, and 36A. These are shown under the ordering information section. Graphics, keyboard, and monitors are ordered separately for the Model 20.

Available Series 200 software includes electrical and mechanical engineering, mathematics, statistics, utilities, test discs, a terminal emulator, and a 9835/45 to Series 200 BASIC translator.

Interfacing Capabilities

The following external interface cards and memory enhancements are available for the Series 200 computers.

The 98620B DMA Controller Card provides two DMA channels for faster I/O data transfer.

The 98622A GPIO Interface provides 16 bits of latched input and output data for bidirectional information transfer, and permits interfacing to GPIO-compatible equipment.

The 98623B BCD Interface connects the Series 200 computer with bit-parallel, digit-parallel, binary-coded decimal devices for data input.

The 98624A HP-IB Interface allows communicating with as many as 14 HP-IB compatible instruments, in addition to the capability provided by the built-in HP-IB interface.

The 98626A Serial Interface provides bit-serial communication between the Series 200 computer and asynchronous EIA RS-232-C devices. (This interface is built into the Model 16 only.)

The 98627A Color Video Interface allows connecting to an external RGB color monitor, giving enhanced soft graphics output.

The 98628A Data Communications Interface provides both protocol management and electrical levels for asynchronous serial communications. This card supports the Distributed System Network/Data Link protocol for communications to an HP 1000 series minicomputer.

The 98259A Magnetic Bubble Memory Card features 128Kb of nonvolatile mass storage.

The 98255A EPROM Card contains 16 sockets for EPROMS to allow up to 256Kb of storage using Intel 27128A EPROMS or equivalent. The 98253A EPROM Development Kit consists of one EPROM programmer card and one 98255A EPROM card.

The 98634A HP-IL Interface allows interfacing to HP-IL compatible instruments via the Hewlett-Packard Interface Loop.

The Programmable Datacomm Interface product provides broad capabilities that can be tailored to meet special datacomm and/or serial interfacing needs. It includes the 98690A Development Package and the 98691A Interface Card.

Please see page 604 for ordering information.

HP 9845 Computer

The HP 9845, an integrated desktop computer, includes a CRT display, built-in page-width thermal printer, dual tape cartridge drives, keyboard, and dual processors. It is suited for engineering design, statistical analysis, mathematical modeling, data acquisition and control, and business management.

There are two models. The 9845B provides up to 1.6Mb of memory, monochromatic CRT, read-only memories (ROMs), and BASIC language. Assembly language is available for experienced programmers, and FORTRAN and Pascal are available through third-party software suppliers. The 9845C adds full-color graphics, providing up to 4913 different color shades. An optional light pen allows constructing and moving objects on the CRT screen.

The 9845 provides 15 levels of priority interrupt, direct memory access (DMA), and can interface to a variety of peripherals. Various software packages are available for engineering, statistical, mathematical, and management applications.

Please see page 604 for ordering information.

*HP-IB is Hewlett-Packard's implementation of IEEE Standard 488-1978.



9020B

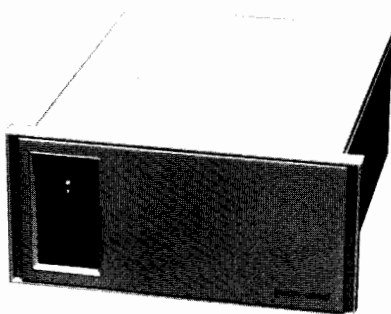

9030A



9040A



HP 9000 Models 20, 30, and 40 Computers

The HP 9000 computer family consists of 32-bit computers in several forms that can be configured to solve a wide range of scientific and engineering problems. These computers feature an integrated workstation with keyboard, printer, mass storage and graphics display mounted in an integrated unit (Model 20); or a component configuration that permits selecting the peripherals you need. This configuration is packaged in either a rack-mountable box (Model 30) or a stand-alone cabinet (Model 40).

The Model 20 is available with either a UNIX* operating system (HP-UX) or an enhanced version of the HP BASIC language system. The BASIC system is single-user, while the HP-UX system offers single- or multi-user versions. Models 30 and 40 offer only the HP-UX system.

Model 20 Standard Features

The standard HP 9000 Model 20 features a CRT display, 5 1/4 inch flexible disc drive, ASCII keyboard, power supply, memory/processor module, four I/O slots on the backplane (DMA), single CPU and I/O processors, 512Kb of RAM and optional thermal printer in an integrated package. The Model B and S versions (models 9020B and 9020S) include a 12.2-inch monochrome CRT. Models C and T (9020C and 9020T) include a 13-inch high-performance color CRT.

For the Model 20 BASIC language systems only, a light pen is available, orderable as Option 775, or as a field-installed upgrade, P/N 98775A.

HP 9020 Bundled Systems

The 9020S and 9020T include several software products at a favorable package price. These are single-user systems, and although they will run multi-user software, it is more cost-effective to base multi-user systems around the 9020B or 9020C, which do not automatically include single-user software. Models 9020S and 9020T include a 455 x 560 pixel CRT display; ASCII standard keyboard; 1 Mb RAM; four I/O slots on the backplane (DMA); 5 1/4 inch flexible disc drive; 10 Mb Winchester fixed disc drive; thermal line printer; power supply; BASIC language system; 2D-3D Graphics (BASIC); single-user HP-UX operating system, FORTRAN compiler, Pascal compiler, and Graphics/9000; and appropriate manuals.

Model 30 and 40 Standard Features

The Model 30 is a rack-mountable "box" configuration of the HP 9000. The Model 40, the mini-cabinet version, is available as either the 9040A or the 9040S, which is a multi-user bundled system. Model 30 and Model 40 standard features include a rack-mountable 19-inch box (9030A) or mini-cabinet enclosure (9040A/S), 512 Kb RAM, a single I/O processor with seven available DMA channels, a real time clock, power supply, and an installation and test manual. Required peripherals include one terminal (HP 2622A, 2623A, 2626A, 2627A, or 2647F; an HP 27128A Asynchronous Serial Interface or 27130A 8-Channel Multiplex card for the terminal; a system disc with integrated backup (HP 7908P, 7911P, 7912P, or 7914P); and an HP 27110A HP-IB Interface for the system disc (included with the 9040S).

HP 9040S Bundled System

Several software and hardware products are bundled into the 9040S; none is included with the 9030A or 9040A. Models 30 and

40 are available only with the HP-UX operating system, which must be loaded from a mass storage device at power-up. The 9040S bundled system includes 1 Mb RAM; multi-user HP-UX Operating System, FORTRAN Compiler, Pascal Compiler, and GRAPHICS/9000; HP 27110A HP-IB Interface card; HP 27130A 8-Channel Multiplex Interface card; and appropriate manuals.

Expandable Memory

The HP 9000 system's central processing unit, RAM, and I/O processor boards reside in the memory/processor module. Each CPU, RAM, and I/O processor board uses one of the 12 slots provided in the module. The HP 9000's RAM can be expanded by adding the desired number of 256Kb boards, with a maximum of 2.5 Mb. Each board is ordered as Option 240 (or as HP 97040A for a field-installed board).

System Software

The Model 20 can be configured with the HP BASIC System or with HP-UX, an enhanced UNIX* system, or both. The BASIC system provides the BASIC language and operating system (single-user), and allows access to the following BASIC software:

	HP Product Number
BASIC 3D Graphics	97052A
IMAGE-QUERY DBMS	97053A
Asynchronous Terminal Emulator	97056A

All HP 9000 models can be configured with HP-UX in either single-user or multi-user capabilities. For the Model 20, the single-user HP-UX is ordered as HP 97070A; multi-user is 97080A. For Models 30 and 40, the single-user HP-UX is 97079A; multi-user is 97089A. The HP-UX System allows access to the following software:

	HP Product Number	
	Single-user	Multi-user
FORTRAN 77 Compiler	97071A	97081A
HP Pascal Compiler	97072A	97082A
IMAGE DBMS	97073A	97083A
GRAPHICS/9000	97074A (DGL) & 97075A (AGP)	97084A (DGL) & 97085A (DGP)
Asynchronous Communications Software	97076A	97076A

Interfaces

The HP 9000 I/O processor communicates with external devices through a specially designed I/O channel that is independent of the host computer. Interfaces include HP-IB (27110A), which allows communication with up to 14 HP-IB devices; General Purpose (P/N 27112A), for 8- or 16-bit parallel communication; Asynchronous Serial (P/N 27128A), for interfacing to RS-232-C peripherals and terminal emulation; and the Asynchronous 8-Channel Multiplex (P/N 27130A), for interfacing with up to eight RS-232-C devices with a single interface. An I/O Expander (P/N 97098A) is an external card cage supported by the Model 20's BASIC language system, providing access to an additional eight channels with direct memory access capability on each channel.

*UNIX is a trademark of Bell Laboratories, Inc.



COMPUTERS, PERIPHERALS & CALCULATORS

Technical Computers

HP 9000 Family

Series 200 Computers

9816A Model 16A Computer
9816S Model 16S Computer (W/RAM-based BASIC)
9826A Model 26A Computer
9826S Model 26S Computer (W/BASIC and Pascal)
9836A Model 36A Computer
9836S Model 36S Computer (W/BASIC and Pascal)
9836C Model 36C Color Computer
9836CS Model 36CS Color Computer System (includes BASIC, Pascal, and 640Kb RAM)
9920A Model 20A Modular Computer
9920S Model 20S Development System (includes keyboard, BASIC, Pascal, and 640Kb RAM)
98601A ROM-based BASIC 2.0 Language System***
98604A ROM-based HPL 2.0 Language System***
98611A RAM-based BASIC 2.0 Language System***
98612A BASIC Ext. 2.1 (Requires BASIC 2.0)***
98614A RAM-based HPL 2.0 Language System***
98615A RAM-based Pascal 2.1 Language System***
98256A 256Kb RAM Board
98270F Powerfail Upgrade (Model 26/36 only)
98620A 2-Channel DMA Controller
98253A EPROM Development Kit
98255A EPROM Card
98259A Magnetic Bubble Memory
9888A Bus Expander
98622A 16-bit GPIO Interface
98623A BCD Interface
98624A HP-IB Interface
98625A Disc Interface (Pascal and SRM only)
98626A RS-232 Serial Interface
98627A Color Video Interface
98628A Datacomm Interface (BASIC and Pascal only)
98629A Resource Management Interface
98630A Breadboard Card
98634A HP-IL Interface
98690A Programmable Datacomm I/O Development Package
98691A Programmable Datacomm I/O with 4Kb RAM

***Order one flexible disc media option as follows:

Option 630 For use in 3-1/2 inch external flexible disc drives

Option 650 For use in 5-1/4 inch external flexible disc drives

Option 655 For use in 5-1/4 inch internal flexible disc drives

9845B/C Computers

9845B Option 175 Monochromatic, standard performance computer with data communications package
9845B Option 275 Monochromatic, high-performance computer with data communications package
9845B Option 280 Monochromatic, high-performance computer with database management package
9845C Option 275 Color, high-performance computer with data communications package
9845C Option 280 Color, high-performance computer with database management package
98032A 16-bit Parallel Interface
98033A BCD Input Interface
98034B HP-IB (IEEE-488) Interface
98035A Real Time Clock
98036A RS-232-C Serial Interface
98040A Incremental Plotter Interface
98041A Disc Interface
98046B Data Communications Interface

HP 9000 Computers*, †

9020B HP 9000 Model 20 base system w/high-performance monochrome CRT display
9020C HP 9000 Model 20 base system w/high-performance color CRT display
9020S HP 9000 Model 20 single-user bundled system, monochrome CRT
9020T HP 9000 Model 20 single-user bundled system, high-performance color CRT

9030A HP 9000 Model 30 base system packaged in System II rack enclosure

9040A HP 9000 Model 40 in stand-alone cabinet

9040S HP 9000 Model 40 multi-user bundled system

***Opt. 500** Series 500, single CPU (specify in order)

†**Opt. 605** 5-1/4" Flexible Disc (must be specified at time of order unless Opt. 610 is ordered)

HP 9000 Factory Installed Options

Opt. 240 256Kb RAM Finstrate

Opt. 241 Second I/O Processor

Opt. 242 Third I/O Processor

Opt. 590 Internal thermal printer w/8-1/2" x 11" paper

Opt. 591 Internal thermal printer w/210mm paper – for 9020S only

Opt. 610 10Mb Fixed disc drive w/5/4" flex disc drive

Opt. 775 Light Pen (BASIC systems only)

HP 9000 Field Installed Options

97040A 256Kb RAM Finstrate

97041A Second I/O Processor

97042A Third I/O Processor

97090A Internal Thermal Printer with 8-1/2" Paper

Opt. 591 Replace 8-1/2" paper with 210mm

97093A Add 10Mb Disc to Model 20

98775A Add Light Pen to Model 20

97098A I/O Expander

HP 9000 BASIC Language Software (Model 20 only)

97050A BASIC Language System

97052A 3D Graphics

97053A IMAGE-QUERY DBM

97056A BASIC Async. Terminal Emulator software

98354A HP-FE II software

98355A HP-DESIGN software

Distribution media for above software

Opt. 042 on 5-1/4" flexible disc

HP 9000 HP-UX Software

97070A HP-UX Operating System(OS), Model 20 only, single-user

97080A HP-UX OS, Model 20 only, multi-user

97079A HP-UX OS, Models 30 & 40, single-user

97089A HP-UX OS, Models 30 & 40, multi-user

97071A FORTRAN 77 Compiler, single-user

97081A FORTRAN 77 Compiler, multi-user

97072A HP Pascal Compiler, single-user

97082A HP Pascal Compiler, multi-user

97073A IMAGE DBM, single-user

97083A IMAGE DBM, multi-user

97074A GRAPHICS/9000 (DGL), single-user

97084A GRAPHICS/9000 (DGL), multi-user

97075A GRAPHICS/9000 (AGP), single-user

97085A GRAPHICS/9000 (AGP), multi-user

97076A Asynchronous Communications software, single/multi

98163A HSPICE Circuit Simulation, single-user

98183A HSPICE Circuit Simulation, multi-user

Distribution media for above software

Opt. 042 on 5-1/4" flexible disc

Opt. 022 on 1/4" tape cartridge

HP 9000 HP-CIO Interface Cards

27110A HP-IB Interface (includes 2m cable)

27112A GP-IO Interface (W/5m terminated cable)

Opt. 001 Replace standard cable w/5m HP 9885 Disc Interface cable

27128A Async. Serial Interface (includes 5m RS-232-C cable w/female connector to connect to terminal)

Opt. 001 5m terminal emulation cable (male connector for connection to modem)

27130A 8-Channel Multiplex Interface Card

27132A HP-CIO Technical Reference Binder

27116A HP-CIO Extender Card

COMPUTERS, PERIPHERALS & CALCULATORS

Dedicated Real-Time Computer Systems

HP1000 Systems

605



- Computer-aided manufacturing
- Computer-aided design
- Computer-aided test



HP 1000 Computers—Real-Time Solutions for Manufacturing and Engineering

HP 1000 Computers are a complete family of computers, systems, and software uniquely qualified to satisfy your manufacturing productivity needs at every level. HP 1000 computer products provide you with the power and versatility needed for those real-time, number crunching applications—from process monitoring and control, to supervising a network of computers.

New A900 Computer for Your Most Demanding Tasks

The newest member of the HP 1000 family is the A900, a distributed intelligence I/O machine that incorporates a pipeline implementation and cache memory to achieve an incredible speed of 1.3 IBM MIPS, making it the fastest, real-time minicomputer in the world. The A900's built-in floating point hardware with scientific and vector instruction sets is well-suited for computation-intensive tasks in graphics, computer simulation, and process control.

HP 100 Computers—Flexibility and Compatibility for Your Application

With the HP 1000 family of real-time computers, tailoring a computer solution to your application is a simple matter of choice. First, select the computer power you need from the A, E, or F-Series of HP 1000 computers. Next, choose from four levels of packaging—component-level board computers, rack-mountable box computers, microsystems, which are available in a convenient vertical floor mounting roll-around package, and totally integrated systems. Then fine-tune your HP 1000 to the intended task by choosing from an array of hardware and software products designed to help you get results over a wide range of specific applications.

Compatibility of design throughout the HP 1000 family enables you to harness the precise level of power you need for a specific application. It also gives you a clear growth path. Once you've matched the proper combination of HP 1000 products to your initial needs, you remain free to choose an impressive number of options to keep pace with your growth. Or, if your needs change, you can smoothly reconfigure your HP 1000 to handle new applications. This compatibility extends through:

- HP 1000 Computers. The A, E, and F-Series computers use the same basic instruction set, so you can change models to fit your needs, with little effect on software, peripherals, or operator training. Within the A-Series, application software will run on all three processors with no change. This gives you the benefit of a cost effective computer on which to run your applications, while enjoying "supermini" program development features.
- HP 1000 Systems. You can move up from the smallest memory-based system to the largest disc-based system at any time—at once or in increments.
- HP 1000 Operating Systems. Compatibility is the strength of HP's Real-Time Executive (RTE) operating system software. Choose the RTE that suits your application. Programs written on one RTE, using our high level languages, will execute on others with minimal modification (no modification between A-Series computers).
- HP 1000 Software. HP 1000 software products for data base management, graphics, and distributed systems networking are available to help you tailor a solution to your specific needs.

HP 1000 Computer Systems

The HP 1000 systems family consists of nine models with various levels of capability. Each model includes an RTE operating system and basic system processor unit hardware. With a hard disc and optional software, each model can be used to develop programs in BASIC, FORTRAN 77, Pascal, and Macro/1000 assembly language. All systems also support data base management, graphics, and distributed systems networking.

HP 1000 systems support sharable memory-resident data arrays up to 2 megabytes and virtual data arrays up to 128 megabytes in main memory and on disc. A new enhancement package to RTE-A, called VC+, provides virtual code for the development and execution of large programs—up to 7.75 megabytes, with automatic and transparent segmentation.

A wide choice of peripherals, I/O cards and software can be added to work together on your applications to maximize the value of your system investment. HP 1000 computers are well-suited to many application areas, but especially those listed on the following page.



COMPUTERS, PERIPHERALS & CALCULATORS

Dedicated Real-Time Computer Systems (cont.)

HP 1000 Systems

Plant Automation

HP's wide range of hardware and software supports automation of instruments and machines as well as monitoring and control of real-time processes. The HP 1000 can help improve productivity and reduce costs. For low point-count data acquisition, test and control applications, A-Series Measurement and Control Cards provide many analog interfacing functions without the need for an add-on peripheral device. For details, see page 58.

Computer Networking

HP's DSN software makes it easy to connect HP 1000 systems and other systems across a city or a continent, sharing vital information throughout the network.

Data Base Management

Informed management decisions flow easily and confidently from the timely, accurate information maintained in an Image/1000 data base.

Interactive Graphics

Hewlett-Packard offers a complete line of graphics hardware and software — products for simplifying presentation of complex data or developing product designs. In addition to supporting the traditional

graphic displays such as bar charts, pie charts, and histograms, Graphics/1000 software gives you the interactive, two and three dimensional capability needed for computer-aided drafting, mapping and design.

Automated Test Systems

An HP Automated Test System can be configured from the HP 1000 E and F-Series computers and a wide range of electronic instruments to perform virtually any electronic test application. Whether you're testing microcircuits or aircraft engines, an ATS/1000 system can include all the hardware and software needed for fast, accurate, and thorough testing.

Ordering Information

- HP 1000 Model 6+ Microsystem with minifloppy discs
- HP 1000 Micro 26 Computer System w/512kb memory
- HP 1000 Micro 27 Computer System w/512kb memory
- HP 1000 Micro 29 Computer System w/768kb memory
- HP 1000 Model 26 Computer System w/512kb memory
- HP 1000 Model 27 Computer System w/512kb memory
- HP 1000 Model 29 Computer System w/768kb memory
- HP 1000 Model 60 Computer System w/256kb memory
- HP 1000 Model 65 Computer System w/256kb memory

HP 1000 System Summary

	Model 6+	Micro 26	Micro 27	Micro 29	Model 26	Model 27	Model 29	Model 60	Model 65
Base system computer type	2186C/D	2486A	2487A	2489A	2196C/D	2197C/D	2199C/D	2178C	2179C
Memory Cycle Time	454 ns	454 ns	500 ns	181 ns*	454 ns	500 ns	181 ns*	665 ns	420 ns
Operating System	RTE-A	RTE-A	RTE-A	RTE-A	RTE-A	RTE-A	RTE-A	RTE-6/VM	RTE-6/VM
Virtual Code+ available?	Yes	Yes	Yes	Yes	Yes	Yes	Yes	No	No
Recommended system console terminal	262x	262x	262x	262x	262x	262x	262x	262x	262x
Maximum Memory	3Mb	4Mb Parity	4Mb Parity or 2Mb ECC	1.5Mb ECC	1Mb Parity	4Mb Parity or 2Mb ECC	6Mb ECC	2Mb Parity or ECC	2Mb Prty or ECC
Recommended system disc	9133A/B 4.6/9.2Mb	248xA, Opt 110, 9.4Mb fixed & 270kb microfloppy disc			7908R (16.5Mb)	7911R (28.1Mb)	7914R (132.1Mb)	7911R (28.1Mb)	7911R (28.1Mb)
Alternative disc choices	7908/7911/7912/7914/P/R/7933H/7935H 16.5Mb/28.1Mb/65.6Mb/132.1Mb/404Mb/ 404Mb fixed disc				7908R/7911R/7912R/7914R/ 7933H/7935H 16.5/28.1/65.6/132.1/404/404Mb fixed disc			7906M/MR/7908R/ 7911R/7912R/7914R/ 7920M/7925M/7933H/ 7935H 19.6/16.5/28.1/65.6/ 132.1/50/120/404/404 megabyte fixed disc	
Flexible disc available?	Yes	Yes	Yes	Yes	Yes	Yes	Yes	Yes	Yes
H/W floating point?	No	No	Optional	Yes	No	Yes	Yes	No	Yes
Graphics/1000-II available?	Yes	Yes	Yes	Yes	Yes	Yes	Yes	Yes	Yes
HPSPICE Crt Simln available?	No	No	No	No	No	No	No	No	Yes
Programmable Controller Interface available?	Yes	Yes	Yes	Yes	Yes	Yes	Yes	Yes	Yes
2250 Meas & Ctrl Proc av?	Yes	Yes	Yes	Yes	Yes	Yes	Yes	Yes	Yes
Meas & Cntrl I/F available?	No	Yes	Yes	Yes	Yes	Yes	Yes	No	No
Image/1000-II available?	Yes	Yes	Yes	Yes	Yes	Yes	Yes	Yes	Yes
DS/1000-IV communication w/HP 1000 & 3000 available?	Yes	Yes	Yes	Yes	Yes	Yes	Yes	Yes	Yes
Communication with IBM systems available?	Yes	Yes	Yes	Yes	Yes	Yes	Yes	Yes	Yes
Data Link support?	Yes	Yes	Yes	Yes	Yes	Yes	Yes	Yes	Yes
ATS/1000 Integration Services available?	No	No	No	No	No	No	No	Yes	Yes

* Average effective access time, assuming 88% cache hit rate.

COMPUTERS, PERIPHERALS & CALCULATORS

HP 1000 A-Series, E-Series, and F-Series Computers

607

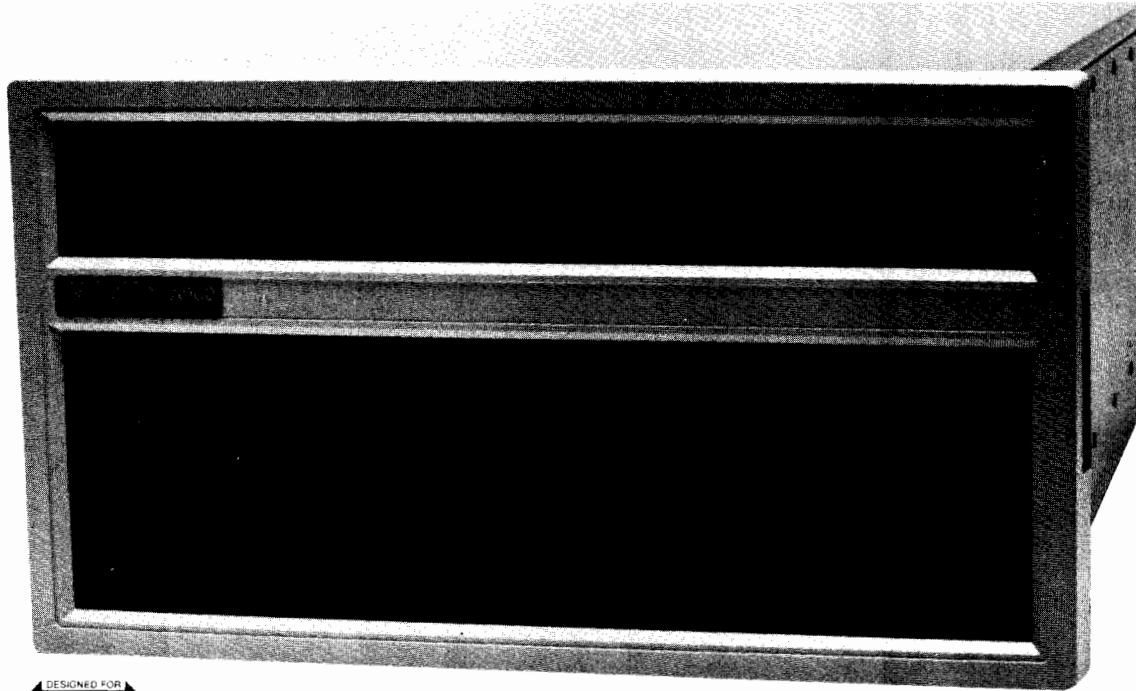

HP 1000 A-Series

A-Series computers implement a distributed intelligence I/O design in which each I/O card has its own processor. This processor controls direct access transfers to/from memory with extra intelligence that supports chained multiblock transfers without interrupting the CPU. This leaves the CPU free to concentrate on arithmetic tasks with few interruptions and great efficiency.

The A600+ microcomputer offers one million instructions per second execution speed, and double precision floating point firmware for real-time operation. The A600+, price/performance leader of low-cost microcomputers, supports VC+ enhancements, and is available as a two-board computer, box computer, and microsystem component.

The A700 computer adds optional floating point hardware with scientific and vector instruction sets and optional ECC memory to the basic performance capability of the A600+ microcomputer for superior support of computer simulation, graphics, and other computation-intensive uses. The A700 is also microprogrammable, so it can be optimized for higher performance or user-customized applications. It is available as a four or five-card board computer, box computer, and microsystem component.

The A900 computer incorporates a pipeline implementation and a cache memory scheme, providing three times the performance of an A700 computer. The A900's hardware floating point processor and scientific vector instruction sets are built-in, and 768k bytes of ECC memory is standard, assuring system integrity. The A900 is the ultimate computation machine designed to meet the most demanding needs of OEMs, system designers, software suppliers and end users.

HP 1000 E-Series

The E-Series computer provides variable microcycle timing, microprogrammable block I/O, a microprocessor port, asynchronous memory, and large control store address space. E-Series computers are available in two models, HP 2109E and 2113E, with up to 2 Mbytes of mainframe memory and 9 or 14 I/O channels, expandable to 46 channels. (Also available as 2109EK board computer.)

HP 1000 F-Series

For users who need faster than E-Series processing speed, HP offers the HP 2117F computer which features a hardware floating point processor that speeds calculations (2.2 to 6 times faster than E-Series) and a scientific instruction set for fast execution of trigonometric

and logarithmic functions (compute sine in less than 48 microseconds). A fast FORTRAN processor, also standard in the 2117F, provides firmware microcode for over a dozen instructions—e.g., array address calculations, parameter passing, and other routines—that run 2 to 20 times faster than conventional software execution speed. An optional vector instruction set can be provided for fast matrix calculations. The 2117F computer features high performance 420 ns memory and is fully user-microprogrammable.

Alternate Memory Systems

HP continues its lead in memory technology by being the first to offer 64k RAM memory: a 512k byte board for the E and F-Series, a 1 megabyte board for the A600+, and A700, a 512k byte Error Correcting Code (ECC) memory board for the A700, and a 768k byte ECC memory board for the A900.

Parity checking memory is standard in HP 1000 memory systems for the A600+, A700, and E and F-Series. And, for very large systems in critical applications, Error Correcting Code (ECC), standard in the A900 and optional in the A700, and E and F-Series, detects and corrects all single-bit errors and detects all double-bit errors.

Ordering Information

- 2106BK A600+ Board Computer w/128 kb memory
- 2107AK A700 Board Computer w/128 kb memory
- 2156B A600+ Computer w/128 kb memory
- 2137A A700 Computer w/128 kb memory
- 2139A A900 Computer w/768 kb memory
- 2113E E-Series Computer w/128 kb memory
- 2117F F-Series Computer w/128 kb high perf memory
- 12103A A-Series 128 kb Memory Array Card
- 12103B A-Series 256 kb Memory Array Card
- 12103C A-Series 512 kb Parity Memory Array Card
- 12103D A-Series 1Mb Memory Array Card
- 12104 A700 512 kb Error Correcting Memory Array Card
- 12153A A700 Writable Control Store Card
- 12156A A700 Floating Point Processor
- 12157A A-Series Battery Backup System

Quantity discounts are available.

A complete list of HP 1000 computer accessories is available from your HP Sales Office.



COMPUTERS, PERIPHERALS & CALCULATORS

Technical Computer Peripherals

Interfacing Summary

This table shows peripherals that can be connected to many Hewlett-Packard technical computers to solve particular problems. Information about the EMI compliance and support of a specific system is available from a Hewlett-Packard sales office in your area.

HP Technical Computer Interfacing Summary

Peripherals	Ref Page	Technical Computers											
		85B & 85B I/O Systems			9816#			9845		9020#		9030#	1000 Series
		86B	87XM	8915	H	B	P		B	U	U	E,F	A
9111A Graphics Tablet	634	•											
9885M/S Flexible Disc Drive	618												
9895A Flexible Disc Drive	618	•											
82901M & 82902M Flexible Disc Drive	618	•											
7906M/S Hard Disc Drive	620												
7908P/R Hard Disc Drive	621												
7911P/R, 7912P/R, 7914P/R Disc Drive	621												
7920M/S, 7925M/S Disc Drive	620												
7933H/7935H Disc Drive	621												
9121S/D Single/Dual 3½" Flexible Disc Drive	618	•											
9133V Winchester 3½" Microflop Disc Drive	619	•											
9133XV Winchester 3½" Microflop Disc Drive	619												
9134XV Winchester Disc Drive	619												
7970B ½" Tape Drive	617												
7970E ½" Tape Drive	617												
7971A ½" Tape Drive	617												
7974A ½" Tape Drive	617												
7976A ½" Tape Drive	617												
37201A HP-IB Extender	40	•											
37203A HP-IB Extender	41	•											
37203L HP-IB Extender	41	•											
37212A Modem	625	•											
37213A/4A/5A/6A System Modems	625												
37222A Modem	625												
9888A I/O Expander	604												
7220T Eight-color Plotter	630												
7221T Eight-color Plotter	630												
9872T Eight-color Plotter	630	•											
7470A/7475A Graphics Plotters	628	•											
7580B/7585B Drafting Plotters	632	•											
2601A Daisywheel Printer	622	•											
2602A Daisywheel Printer	622	•											
2563A Line Printer	624												
2671A Printer	623	•											
2671G Graphics Printer	623	•											
2673A Intelligent Graphics Printer	623	•											
2932A Dot Matrix Transaction Printer	623	•											
9876A Thermal Graphics Printer	623	•											
82905B, 82906A Impact Printer	622	•											
1351S Graphic Display System	637												
2382A Office Display Terminal	610												
2621B CRT Terminal	611												
2622A Terminal	611												
2623A Graphics Terminal	612												
2624B Terminal	613												
2626A Terminal	613												
2627A Color Graphics Terminal	612												
2635B Hard Copy Terminal	623												
2645A CRT Terminal	614												
2647F CRT Graphics Terminal	614												
2648A CRT Graphics Terminal	614												
2674A Internal Printer	623												

H = HPL; B = BASIC; P = Pascal; U = HP-UX (HP-Unix)

★ Depends on application; not all functions may be implementable.

COMPUTERS, PERIPHERALS & CALCULATORS

Speech Output Module

Model 27201A

609



- High quality speech output
- Hardwire RS-232 peripheral
- Low cost

- RAM or EPROM based
- Over 1500 words and sounds available
- Dialog design tools available



27201A

Welcome to the world of computer speech. HP's new speech output module makes speech synthesis a viable technology for a wide variety of computer-based applications. The HP 27201A Speech Output Module (SOM) offers you high quality speech, low price, and flexible configurability.

Applications

The SOM is most useful for applications where prompting, warning, or error messages are required, or where a person is concentrating on or looking at something other than the computer.

In an office, you can benefit from the HP 27201A announcing receipt of electronic mail. In an electronic data processing center, the SOM can prompt you to load a magnetic tape or notify you that a printer is out of paper.

There are speech output applications in engineering environments. For example, in computer-aided design, a CRT filled with schematic information does not have to be overwritten with error messages. In computer-aided-test, a technician will not have to look at the screen for the results of a probe test, the SOM can advise pass or fail information.

Other prime applications include facilities monitoring, process control, graphics, inventory management, and computer-aided manufacturing.

Easy to Use

The SOM is a small device that connects directly to a host computer or interconnects a host and another peripheral (such as a terminal, printer, or plotter). It communicates via a three-wire RS-232-C hardwired line at speeds up to 19,200 bits per second. An on-board micro-processor controls the 27201A by performing handshaking sequences with the host computer, interpreting 27201A commands and managing the flow of data. Vocabulary data can be downloaded from the host computer or resident on the 27201A in customer supplied EPROM. EPROM-based vocabularies can include up to 200

words, while the downloaded vocabulary is limited only by host memory.

Software packages for the HP 1000 and HP 3000 computer systems include a word library of more than 1700 words and sounds, and an exerciser program to preview words and phrases and store them in files, all without writing a program.

Ordering Information

27201A Speech Output Module including: one 16K-bit RAM; 27201-60003 cable for connection to HP 262X terminals capable of supplying power (i.e., 262X with built-in printer); phone plug for attachment to user supplied speaker; hardware reference manual; monaural headphone

Opt 001: Adds five 16K-bit RAM

Opt 002: Substitutes cable 27201-60004 which adds 115V ac power supply for HP 262X terminals with insufficient power for SOM

Opt 003: Substitutes cable 27201-60006 with 25-pin connectors for 264X terminals and general RS-232 hardware devices (includes 115V ac power supply)

27203A SOM Speech Library/1000 software for HP 1000 systems including a software reference manual (media option required)

Opt 022: Cartridge tape (Linus CS-80) compatible with HP 7908/11/12

Opt 042: 5.25 inch floppy disc

Opt 051: 1600 bpi magnetic tape

27205A SOM Speech Library/3000 for HP 3000 systems including a software reference manual (contact HP for software distribution)

COMPUTERS, PERIPHERALS & CALCULATORS

Interactive Display Terminals

Model 2382A

Introduction

Hewlett-Packard's family of interactive terminals feature a wide range of capabilities which are optimized to suit a variety of applications on HP computer systems and software packages. These applications include program development, data entry, document preparation and graphics.

The HP 2382A Office Display Terminal is a block/forms mode display terminal for office use. The 2382A consumes less than a cubic foot of space, which makes it ideal for the office desktop, yet provides many of the high performance features available in larger HP terminals. Non-computer professionals and infrequent computer users, such as managers, will find the 2382A's small size, simple styling and easy to use features the correct solution to their data processing needs.

The HP 2620 family of interactive terminals range from the simplicity of the character mode 2621B, with its two pages of display memory, to the sophistication of the 2626W, which provides word processing, multiple user-defined workspaces and windowing, plus a multipoint data communications capability. The 2622A adds a block/forms mode capability to the 2621B, while the 2623A provides low cost graphics in addition to the features of the 2622A. A new addition to the 2620 family is the 2627A, a low cost, color graphics terminal compatible with the 2623A. The remaining terminal in the 2620 series, the 2624B, provides advanced features ideally suited for data entry applications. The 2620 series (except the 2627A) features the convenience of built-in hardcopy, including graphics hardcopy on the 2623A as an option.

The HP 2640 series of interactive terminals support many of the features and applications that are supported with our 2620 family. The important distinction is that local mass storage is available with the 2640 family. In addition, more standalone operations such as word processing, local programmability in BASIC and graphics software for preparing graphics and slides locally are available in the 2647F.

Terminal discounts for OEM's are available in both the 2620 and 2640 series of terminals.

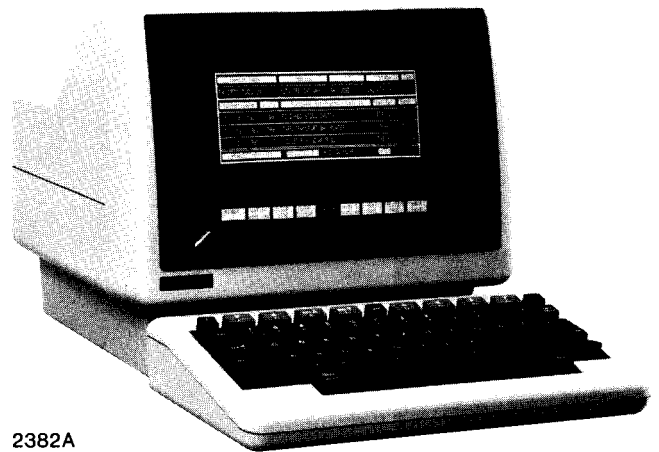

2382A

2382A Office Display Terminal

- Small Size
 - Requires less than 1 cubic foot of space
- High Resolution Display
- 80 Column X 24 lines
- Two pages of display memory
- Four display enhancements
- Block/Forms Mode
- Screen Labeled Softkeys
- Detached Keyboard

The 2382A Office Display features an 80 column by 24 line high resolution display, two pages of display memory, an optional line drawing character set, and four display enhancements including inverse video, half bright, underline and blinking. Screen labeled softkeys allow an application programmer to customize the keyboard to perform several operations with a single keystroke. The detached typewriter style keyboard is familiar and easy to use. The light weight and small size of the 2382A allows it to be positioned where the operator desires so as to minimize operator fatigue. Sculptured keycaps and cursor control keys also make the operator's job easier. With its ANSI option, the 2382A works with ANSI compatible computers in addition to HP computer systems.

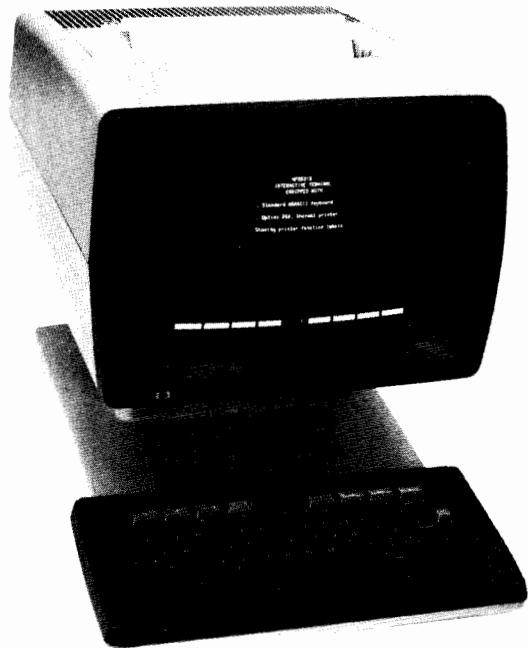

2621B

2621B Interactive Display Terminal

- High resolution display
- Two full pages of memory
- Eight user softkeys
- Optional built-in printer
- Modify Mode

The 2621B can display 1920 characters in 24 lines by 80 column format, and contains two full pages of memory for a review of an interactive dialogue. Local hardcopy is provided by an optional built-in printer, and Modify Mode allows an operator to edit and then transmit any selected line from the terminal's 48 line display memory.

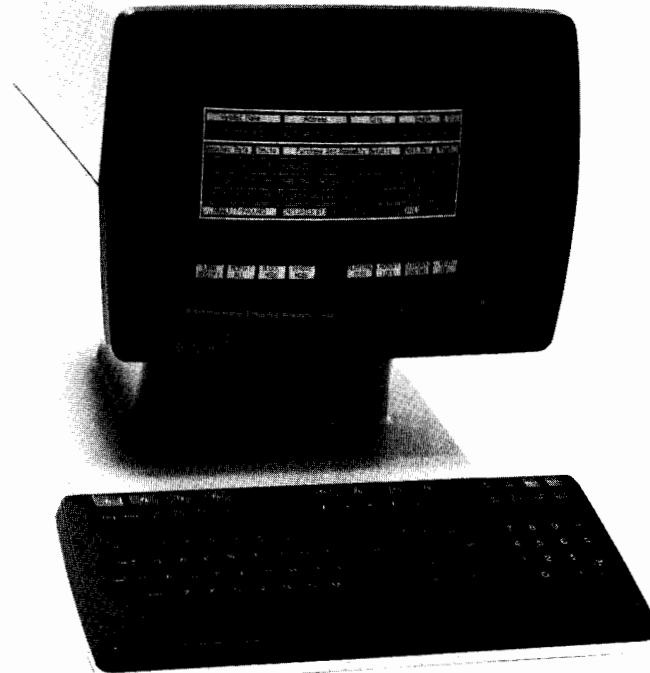

2622A

2622A Display Terminal

- High Resolution Display
7 × 11 dot matrix, 9 × 15 character cell
- Block/Forms Mode
- User Defined function keys,
screen labeled
- Six National Character Sets (optional)
- Integral Thermal Printer (optional)

The HP 2622A has been designed to fit data entry needs. Two pages of display memory, the optional line drawing set, and four display enhancements enable the HP 2622A to be tailored to meet data entry form requirements. The display enhancements which include inverse video, half bright, underline and blinking in all combinations, can be used to depict an existing paper form and to facilitate data entry. A familiar and clear form provides ready acceptance by previous users and accelerates training of new operators. For the programmer, the HP 2622A has several advanced features that increase user productivity. The two pages of display memory allow the programmer to scroll or page through 48 lines of code. Information can be logged to an optional internal printer before it rolls out of memory. The printer can copy a line, page, or the entire display memory in either an 80 or 132 column format.

Besides being compatible with HP computers and software, the 2622A's ANSI option will allow it to communicate with ANSI "speaking" computer systems.

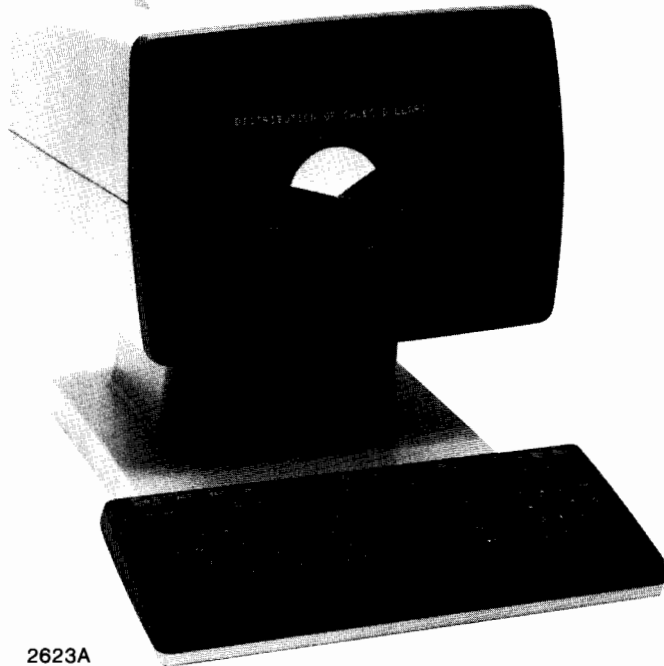

2623A Graphics Terminal

- High Quality Display
512 × 390 dot resolution
TEKTRONIX® 4010 compatible (1024 × 780 dot resolution)
- Built-in Graphics Hardcopy (optional)
- Fast Vector Generation
9600 baud throughput
- Graphics Text Composition in USASCII, and Six National Languages
- 2622A Compatible

The low cost 2623A is designed for the graphics user with an extensive on-line capability and system based software. The high quality display features 512 × 390 dot screen resolution and is ideally suited for many display graphics applications as well as some design applications. An optional built-in printer provides low cost graphic hardcopy in only 30 seconds by simply pressing a key.

The 2623A is supported on HP's Graphics 1000/II and Decision Support Graphics Software. The 2623A also works with other third party software such as TEKTRONIX's Plot 10 and is compatible with the TEKTRONIX® 4010 display terminal. In addition, the 2623A offers an ANSI software compatibility option which allows the 2623A to be used with host computers and application software that support this protocol.

The 2623A can generate vectors at 9600 baud and graphs can be quickly annotated locally in ASCII, or six other optionally available national languages, before obtaining a hardcopy.

All of the alphanumeric capabilities of the low cost block mode 2622A are available in the 2623A.

2627A Color Graphics Terminal

- High Quality Color Display
- Fast Vector Graphics
- Complete Color Alphanumerics
- Graphics Software Support
- Flexible Data Communications
- Hardcopy and Video Interfaces

The 2627A combines a high quality color raster display with fast vector graphics in a compact, low-price package. It's ideally suited to both business and technical display graphic applications where the addition of color enhances the comprehension of relationships and trends.

Eight basic colors are provided by the 2627A, plus hundreds of additional user-defined ones including colors that match HP plotter pens. With vector graphics and local polygonal area filling, it's easy to create precise shapes, symbols and typestyles quickly.

The 2627A not only provides color graphics, but also provides color alphanumerics. Up to eight color pairs (foreground/background) can be used on a per character basis to differentiate lines of text and identify critical fields. In addition, a full set of alphanumeric features are available with the 2627A to make it suitable for a wide range of non-graphic applications.

The 2627A is compatible with HP and major industry graphics software packages. TEKTRONIX® 4010 compatibility mode is offered on the 2627A, allowing it to be used with monochromatic PLOT 10 software.

In addition, the 2627A offers an ANSI software compatibility option which allows the TEKTRONIX® 4010 compatibility mode to operate in either HP or ANSI mode.

®TEKTRONIX is a registered trademark of Tektronix Corporation.

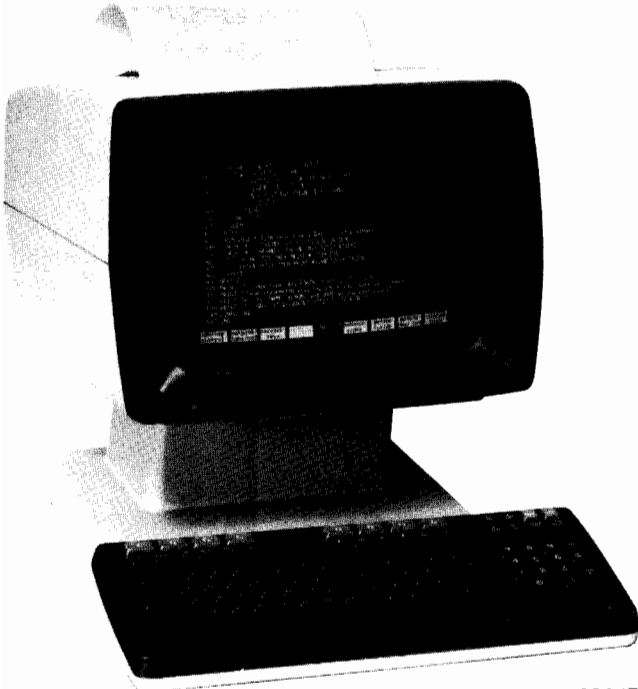

2624B

2624B Display Terminal

- High Resolution Display
- Advanced edit checks
- Local Forms Mode
- Block mode format
- Multipoint
- Terminal bypass mode

The 2624B represents the ultimate in a data entry terminal. Multiple forms can be down loaded from the system and stored in display memory for instant retrieval. This reduces the burden on the system and improves system response time while lowering transmission costs. The advanced edit checks which are supported by the HP 2624B improve data integrity and increase data throughput. In addition to protected, unprotected and transmit only fields, the 2624B provides the first level of data verification through field edit checks. The edit checks allow the terminal to detect many data entry errors and notify the user. By correcting errors at the terminal, system overhead is reduced. The checks include all characters, alphabetic, alphanumeric, numeric, integer, signed decimal and implied decimal. The preprocessing capabilities are justify, fills and implied decimal. Required and total fill fields provide entry control. These capabilities are an asset to applications that do not do data checking today and they reduce system overhead in programs where the computer previously performed all of the data verification.

The 2624B provides comprehensive point-to-point communications as well as multipoint communication so that multiple terminals can share an expensive communications line. In addition, an external printer connected to a 2624B can operate in terminal by-pass mode in multipoint. That is, the printer can be designated as a destination device and information can be sent directly from data comm. to the printer without disturbing the information on the screen or tying up the terminal display.

2626W Word Processing Station

- Complete word processing
- Typewriter like keyboard
- Enhanced screen display
- 2626A data processing



2626W

The HP 2626W Word Processing Station is an intelligent terminal designed for use with HPWORD, Hewlett-Packard's word processing software for HP 3000 computer systems. Careful attention has been given to the user interface of this high performance terminal to enhance user productivity and minimize training time. The typewriter-like keyboard is detachable for operator convenience and the screen-labeled function keys provide a friendly user interface. The terminal is ideal for users with both word processing and data processing requirements.

When the user runs HPWORD, micro-code is downloaded from the HP 3000 and stored locally in the HP 2626W's 64K words of Random Access Memory. This capability is primarily responsible for the quick response that HPWORD offers the user. Any functions performed within a paragraph, such as word wrap, insertions and deletions, take place in the terminal. This feature also reduces the burden on the CPU. When in data processing mode, the 2626W is identical to the 2626A.

2626A Display Station

- Multiple Workspaces
- Multiple Windows
- Dual Data Communications Ports
- Multipoint Data Communications
- Interactive Forms Design

The 2626A is a high performance terminal which provides unique display capabilities and data communications flexibility. The 2626A display memory can be divided into four independent workspaces, and the display screen into four separate windows to examine and manipulate the contents of the workspaces. This capability amounts to four virtual terminals which may be changed from application to application or system to system.

Dual data communication ports can be linked to workspaces to display data from two different computers, or one port may be linked to a computer and the other used as an external RS232 serial printer port. Data may be communicated to the computer using block, line, line modify, or character modes in a point-to-point or multipoint environment.

The 2626A is ideally suited for program development or data entry particularly when taking advantage of the easy to use function key approach to forms design. The line length may be set from 80 to 160 characters so that 132 column reports as well as double width pages may be handled, with viewing via horizontal scrolling.



COMPUTERS, PERIPHERALS & CALCULATORS

Interactive Display Terminals

Models 2645A, 2647F, 2648A



2645A Alphanumeric Display Station

- Integrated Mass Storage
- Forms Mode
- Choice of Communications Capability

The 2645A is a high performance alphanumeric display station that can operate at speeds up to 9600 baud in a fully interactive character-by-character mode or in a variable length block mode. Features such as a high resolution display, forms mode, full editing capability, fully integrated mass storage provided by cartridge tapes, user-defined soft keys, flexible choice of data communications, modular architecture, microprocessor control and hard copy interface make the 2645A the perfect solution for many computer applications.

2647F Intelligent Graphics Terminal

- High Resolution Graphics
- Independent Graphics and Alphanumeric Display Memories
- Graphics Zoom and Pan
- Programmable in BASIC
- 64K Program Workspace
- Automatic Plotting
- Shared Peripheral Interface
- Mini Disc Drive (5-1/4" discs)
- Word Processing Software
- Application Software
- Host System Software Support

The 2647F is the intelligent solution to a host of applications that require on-line capability, graphics, and local programming. The 2647F supports several host graphics software packages in addition to the number of local programming. The 2647F supports several host graphics software packages in addition to the number of local menu/softkey driven application programs that generate slides and charts. The 2647F features a raster scan display, a full interactive alphanumeric capability, optional word processing, and is designed for easy use by secretaries, professionals, and analysts alike.

The 2647F offers sophisticated graphic capability while requiring no programming knowledge of the user. Menu driven, the Auto-

plot/47 software included with the terminal can plot columnar data in multiple formats chosen by the user. Text charts, pie charts, bar charts, X-Y Cartesian and logarithmic graphs can all be created without host CPU graphics software. Different types of shading patterns are available for highlighting the various charts. Data may be submitted to the 2647F from one of three sources: host computer, mini disc or keyboard. One simply fills in the blanks on a menu form which appears on the terminal screen. Once the data parameters are defined, the data can then be plotted with a single keystroke. This powerful feature makes graphs friendly, easy-to-create, and system software independent.

Option software available includes: Word/47, Graphics Presentation Pac/47, Project Management Pac/47, Statistical Analysis Pac/47, Mathematical Analysis Pac/47, and LINK/47. These software pacs are described in data sheets available from your local HP sales representative.

The local disc drive combined with an easy-to-use English language file system puts any file at your fingertips. All file system instructions are command key driven; a few keystrokes implement any file operation. Each 5-1/4" mini flexible disc holds up to 270 Kbytes of information. A second disc drive is available as an option.

RS 232C Data communications is standard, RS 422 is optional.

2648A Graphics Terminal

- Integrated Mass Storage (optional)
- Automatic Plotting

The 2648A is a lower cost alternative to the 2647A. The 2648A provides less standalone capability.

Ordering Information

2382A Office Display Terminal
 2621B Interactive Display Terminal
 2622A Block Mode Terminal
 2623A Graphics Terminal
 2624B Data Entry Terminal
 2626A Display Station Terminal
 2626W Word Processing Station
 2627A Color Graphics Terminal
 2645A Display Terminal
 2647F Intelligent Graphics Terminal
 Opt 072 Second Flexible Mini Disc Drive
 13257G Graphics Presentation Pac/47
 13257H Project Management Pac/47
 13257L Statistical Analysis Pac/47
 13257M Mathematical Analysis Pac/47
 13257N LINK/47
 13257W Word/47
 2648A Graphic Terminal

Opt 007* Integrated Dual Cartridge Tape Unit

Opt 050** Integral Printer

Opt 007* available with the 2645A and 2648A.

Opt 050** available with the 2622A, 2623A, 2624B, 2626A, 2626W.

Opt 072 available with the 2647F



Color Graphics Workstations

Model 2700

HP 2700 Series

High Performance Color Graphics

Models 50, 55, 60, 65

—High Performance Color Graphics

- Local Vector Storage
- Large Addressable Workspace
- True zoom and Pan
- Local 2-D Transformations
- Multiple Views
- Interactive Color Selection

—Independent Color Alphanumerics

—Integrated Dual Mini-Disc Drives (optional)

—Application Software (optional)

- AUTO PLOT/2700
- PAINTBRUSH/2700
- PRESENTATION/2700

—Multiple Hardcopy Interfaces (optional)

—Choice of Communications

The HP 2700 series of high performance color graphics workstations offers models designed for technical and business users. Process control, spectral analysis, circuit design, financial analysis transparency preparation, 35mm slide production, and boardroom display are just a few of the many applications for which the HP 2700 workstations are well suited.

The HP 2700 has powerful local capability to store vectors, group vectors into objects, and then perform manipulations on those objects. These local graphics capabilities can be accessed by a host computer, greatly reducing the data communications and CPU overhead associated with changes to the graphics image. The host computer can distribute parts of the graphics processing to the workstation for an overall performance improvement.

HP 2700 application software permits users to generate charts locally (AUTO PLOT/2700) or sketch electronically on the display from a tablet (PAINTBRUSH/2700). The creation and subsequent modification of graphics images can be performed standalone or by sharing the workload with a host computer.

In addition, high resolution images created by the application software can be transferred to a film recorder for the creation of presentation quality 35mm slides, or sent to the HP 3000 computer for output to the HP 2680 laser printer (PRESENTATION/2700).

Vector list storage is the key to the local graphics processing power of the HP 2700. Graphical information is transmitted to the workstations as a series of X, Y coordinates. The HP 2700 stores the X, Y coordinates in its vector memory and also converts the graphical information into a raster image. Storing images in vector allows the workstation to perform a wide range of functions and graphics manipulations the host computer formerly had to do. This distribution of graphics processing to the workstation dramatically increases performance, significantly reduces the strain on the CPU, and reduces the amount of data which must flow over the data communications line.

The HP 2700 series boasts an addressable resolution from (-16383, -16383) to (16383, 16383) or 32K by 32K. This huge plotting space enables the workstation to store extremely complex images with a resolution of more than one billion addressable points.

The large addressable workspace and local vector storage combine to allow a true local zoom and pan. From the keyboard or via software running on a host computer, the user can zoom from a map of the world to a close-up of a particular country, or from the full view of a printed circuit layout to an individual component. When the operator zooms in, details become visible which were unseen before. Raster memory can be expanded so that the HP 2700 will buffer redraws. When buffering redraws any screen updates will not be seen by the user until they are complete. Zooms and pans will appear smooth.

The HP 2700 uses locally stored vector lists to define the basic characteristics (such as size, shape, and color) of graphics objects. Each graphics object can be scaled, rotated, translated, or copied locally. If an application needs to show the same symbol in several different locations significant data communications time may be saved by sending the vector list once and then instructing the HP 2700 to place copies of it at different locations.

The HP 2700 can show any portion of its large workspace on any portion of the screen. Powerful workstation commands make this process simple. The host does not have to recalculate or resend pictures associated with any of the views, since they are already stored in vector memory. Up to 255 different views may be specified.

Raster scan technology is the basis for the HP 2700's high quality color display. Any 16 of 4096 available colors can be displayed at one time. The wide choice of colors frees the user to select those colors which best suit the application.

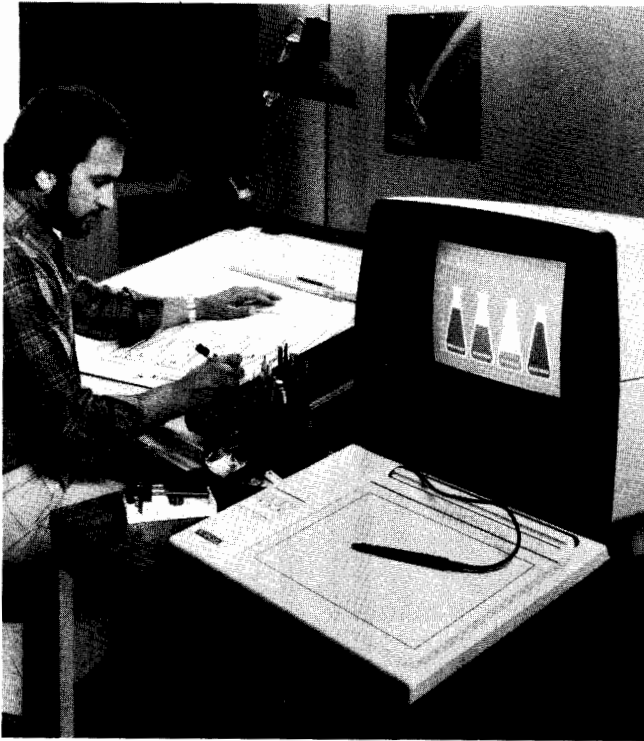

Three local software packages address specific application areas and allows the workstation to operate as a standalone system.

AUTO PLOT/2700 is a powerful yet friendly software application package that lets the first time user create professional looking business charts in minutes. Once data has been entered into the menu, any chart type can be plotted to the display with a single keystroke. By having only one data menu for all chart types, the data can be viewed in pie, bar, line or log form without re-entering the data, making it easy to select the chart type that best presents the data.

PAINTBRUSH/2700 is a software application package that provides a means for drawing, editing, and combining pictures, including **AUTO PLOT/2700** charts. The user can also edit pictures generated by host software.

PAINTBRUSH/2700 and **AUTO PLOT/2700** may be used together to give the user the ability to combine local and host driven charts with freehand graphics.

PRESENTATION/2700 is an application package to link images created on an HP 2700 to a high resolution film recorder or the HP 3000 computer. This greatly expands the high quality output capability of the unit.

The HP 2700 is supported by a variety of Hewlett-Packard software. Three HP software packages designed specifically for graphics applications are **Decision Support Graphics/3000**, **HP DRAW**, and **HP EASYCHART**. In addition to Hewlett-Packard software, the HP 2700 will operate with **ISSCO's DISSPLA®** and **TELL-A-GRAF®** and **Precision Visual's DI-3000®** and **GRAFMAKER®** and **SAS/GRAPH®**.

The HP 2700 supports a variety of output devices for both alphanumeric and graphics hardcopy. An RS-232C serial port for plotters or printers is standard. The optional Shared Peripheral Interface allows multiple HP 2700 models to share the same HP-IB hardcopy devices and permits multiple devices to be daisy chained together. An RGB Video Interface is also available for output to monitors and cameras.

The HP 2700 operates in block or character mode and communicates asynchronously point-to-point at rates up to 19.2K baud. A

choice of RS-232 compatible communications (RS-423) or RS-422 communications is available. Full duplex hardwired and full duplex modem communications are supported.

Ordering Information

Model 50 High Performance Color Graphics Workstation

The HP 2700 Model 50 is a fully functional workstation that can be configured with options and accessories to match any business or technical application. The workstation comes standard with HP 2700 firmware and 224K bytes of local vector storage.

Model 55 Technical Design Workstation

Combining a large amount of local vector storage with control of the graphics cursor through an electronic tablet, the HP 2700 Model 55 is a powerful extension of a host driven computer aided design package. The Model 55 includes 224K bytes of vector storage memory, two sets of raster plans for buffering vector redraws, and a 13273T Graphics Tablet for control of the graphics cursor.

Model 60 Decision Support Workstation

The HP 2700 Model 60 is optimized for generating a wide variety of business charts and slides. For the user who wishes to augment his host driven applications with the ability to locally design quality business graphics, the Model 60 is the appropriate choice. The HP 2700 Model 60 includes 256K bytes of application memory¹, two integral 5¼" flexible disc drives, and **AUTO PLOT/2700** application software.

Model 65 Presentation Graphics Workstation

The HP 2700 Model 65 is ideal for the user who needs to generate custom charts and drawings easily and quickly. The Model 65 has all of the Model 60 features plus **PAINTBRUSH/2700** and **PRESENTATION/2700** software, the 13273T Graphics Tablet for electronic sketching and two sets of raster plans.

SAS/GRAPH® is reg. TM of SAS INSTITUTE INC.
DISSPLA® and TELL-A-GRAF® are reg. TM of ISSCO CORP.
DI-3000® and GRAFMAKER® is a reg. TM of PRECISION VISUALS, INC.

¹ 224K Bytes of Vector storage.

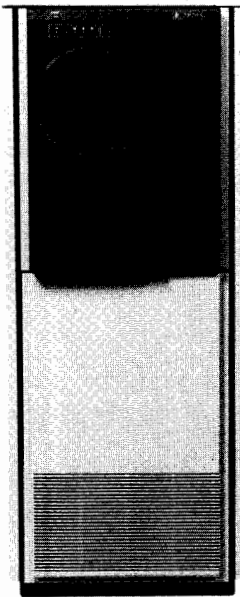

7976A

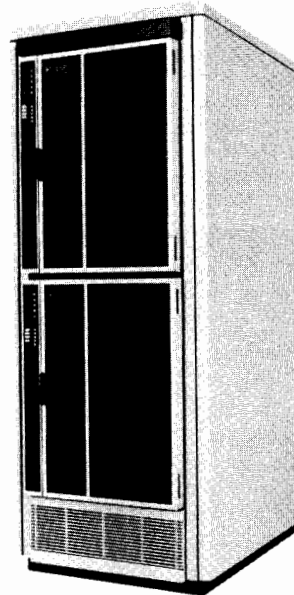

7971A

The Hewlett-Packard Family of Tape Drives provides a range of solutions to meet your format, capacity and performance needs. There are four key types of tape drive applications: 1) Backup for protection against equipment failure and operator error, 2) Archival Storage for economical, long term data preservation, 3) Data exchange with other computers as well as software updates for the system, and 4) Online Mass Storage for data logging and tape processing.

High Performance System Backup

7976A ½" Magnetic Tape Subsystem

The 7976A is particularly appropriate for high speed backup of mass storage systems with greater than 600-700 Mbytes of online storage. It provides both the high density 6250 cpi (GCR) and 1600 cpi (PE) ANSI standard formats and features 75 ips read/write speed (250 ips rewind speed). Back-up performance is increased 3-4 times over the 7970E. The 7976A operates in both the streaming and the start/stop mode. An additional feature of the 7976A is auto tape loading/threading. The 7976A uses an HP-IB interface and is mounted in an upright cabinet.

7976A ½" Magnetic Tape Subsystem

Midrange Solutions

7970B/E

The 7970B/E Magnetic Tape Subsystems offer cost effective support for midrange HP computer systems. They operate in the start-stop mode at 45 ips read/write speed (160 ips rewind speed) and use tension arms as physical tape buffers. Both the 7970B and 7970E systems are available either in a lo-boy cabinet or without a cabinet for rack mounting. They are also available in an upright cabinet by ordering the 7971A described below.

The 7970B is especially valuable for data exchange between HP computers and other systems. It provides 800 characters per inch (cpi) density with NRZI format. The 7970B uses a parallel interface.

The medium speed and low cost of the 7970E make it suitable for backup of midrange systems which have up to 500-600 Mbytes of online storage, for data exchange and for transaction logging to protect real-time data base updates between system backups. It provides a 1600 cpi density, PE format and is available with either a parallel or an HP-IB interface.

7970B ½" Magnetic Tape Subsystem

7970E ½" Magnetic Tape Subsystem

Upright Cabinet 7971A

The 7971A is an upright cabinet containing the 7970B and/or 7970E magnetic tape drives. One or two 7970B/E drives can be combined in one cabinet by ordering the 7971A with the appropriate option.

7971A Upright Cabinet for Tape Subsystem (price for single HP-IB master drive)

HP's Newest Tape Drives

7974A ½" Magnetic Tape Subsystem

The 7974A is a midrange, low cost tape subsystem which is designed to operate in both the start/stop and streaming modes and is formatted with a 1600 cpi (PE) density. The 800 cpi (NRZI) format can be added if dual density is needed. It is ideal to use as a dedicated drive for backup of systems with 100-500 Mbytes of storage and offers a good solution for transaction logging as well as data exchange and archival storage. The 7974A is a true start/stop tape drive operating at a tape speed of 50 IPS with tension arm buffering. In the streaming mode, the drive operates at 100 ips enabling faster back-up (twice as fast as the 7970E). The 7974A uses an HP-IB interface and is mounted in an upright cabinet. A second drive may be mounted in the same cabinet. The 7974A is supported by the HP3000, HP1000, HP9000 and Series 200.

7974A ½" Magnetic Tape Subsystem

800 NRZI option



COMPUTERS, PERIPHERALS & CALCULATORS

Mass Storage Peripherals

Models 9121D/S, 82901M, 9895A, 9885M/S

The HP family of low-cost 3½", 5¼" and 8" flexible disc drives, and 5¼" micro-Winchester disc drives, provides fast, random access to volumes of information on HP personal, desktop and mini-computers. Your price, capacity and performance needs for entry-level, data exchange and heavy usage mass storage applications have all been considered in the design of these products.

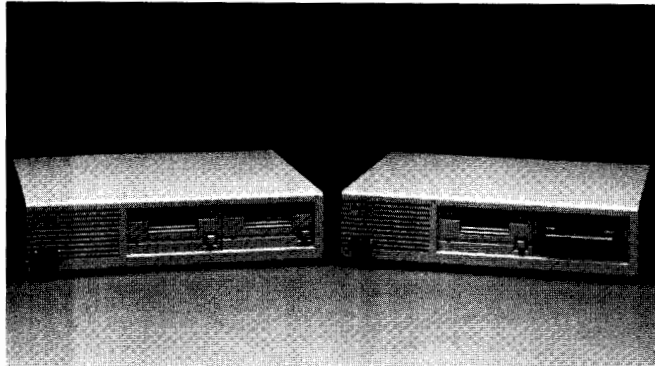

9121D



9121S

Entry Level—3½" Flexible Disc Drives

9121D Dual/Drive—9121S Single-Drive

In addition to low cost, high reliability and speed of random access, the HP 9121D/S offers a small, in-basket size flexible disc drive designed to complement HP's personal computers. The 3½" single sided drive provides the same amount of storage capacity (270 Kbytes) as the 5¼" double sided drive. This capacity is due to the 3½" drive's increased track density of 135 tracks per inch compared to 48 tracks per inch of the 5¼" drive.

The 3½" media used in the 9121 is protected three ways. It is totally enclosed in a shirt-pocket sized, hard plastic envelope. The new auto shutter feature of the drive and media prevents contamination from getting inside. And finally, HP's unique Media Monitor tells you when it is time to replace each piece of media.

Ordering Information

9121D 3½" Dual Drive Flexible Disc
9121S 3½" Single Drive Flexible Disc
92191A HP Qualified Media (Box of 10)

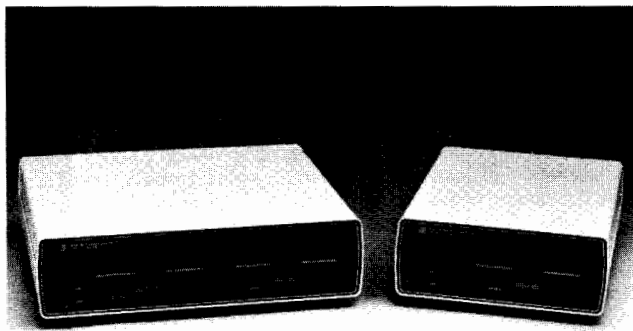

82901M



82902M

Entry Level—5¼" Flexible Disc Drives

82901M Dual Drive/82902M Single Drive

For applications requiring low cost, reliable, on-line access, including small business and professional applications, the 82901 offers the speed of random access combined with 5¼" removable media. The single drive provides 270 Kbytes and the dual drive 540 Kbytes of storage. These 5¼" drives read and write double sided, double density format and provide 187 ms average access time.

Ordering Information

82901M Dual Drive Flexible Disc
82902M Single Drive Flexible Disc
92190A HP Qualified Media (Box of 10)

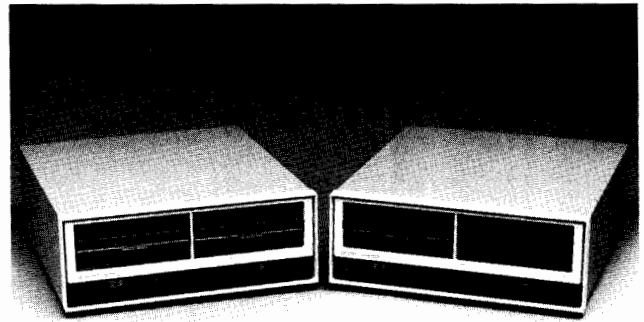

9895A



9895A Opt 010

Data Exchange—8" Flexible Disc Drives

9895A Dual Drive—(opt. 010 single drive)

The HP 8" flexible disc drives provide 8" flexible disc media for large file back-up or data exchange, CP/M® standard software or other media-format needs.

The 9895A dual-drive provides 2.3 Mbytes of removable mass storage plus back-up capability. The Opt. 010 single-drive provides 1.15 Mbyte capacity.

The 9895A reads and writes double-sided, double-density format on HP qualified media. Access time is 179 ms with transfer speeds up to 23 Kbytes/sec. Data exchange with HP and non-HP systems is possible through the 9895A as it reads and writes industry standard IBM 3740 single sided, single density format. This is also the format used for CP/M standard data storage.

Ordering Information

9895A Dual-Drive Master
(Order appropriate mainframe option)
9895A Single-Drive Master (Opt. 010)
(Order appropriate mainframe option)
92195A HP Qualified media (Box of 10)

9885M/S 8" Flexible Disc Drive

The 9885 single-sided double-density mass storage drive provides access time of 267 msec and approximately 500 Kbytes of data per disc. Transfer rate is 46 Kbytes/sec.

This reliable and easy to use flexible disc drive comes in two versions: the 9885M (master) and the 9885S (slave).

Ordering Information

9885M Flexible Disc Drive Master
9885S Flexible Disc Drive Slave
9164-0105 HP Qualified Media (Box of 10)

New Winchester Family Offering

The new family of small footprint Winchester is designed to stack under the HP150 Personal computer or the HP Series 200, Model 16 Technical computer.

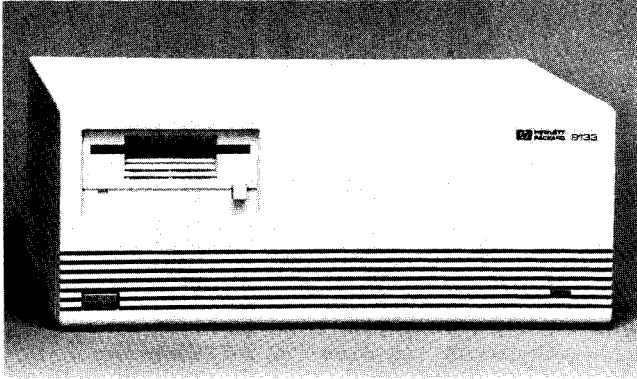

9133V/XV



9133V Winchester/3½" Microfloppy Combination

This drive is combined with a 3½" Microfloppy to provide the user with heavy duty, fast random access and personal I/O capability. The standard unit is formatted into one 4.8 Mbyte volume for the Winchester. Option 004 partitions 4.6 Mbytes into four volumes of 1.5 Mbytes each. The controller of this Winchester drive emulates an HP 9895A 8" flexible disc, which enables most HP computers that support the 9895A to interface to the 9133V.

The integrated 3½" microfloppy adds 270 Kbytes of personal I/O capability for loading operating systems, exchanging data between systems, and doing on-line selected file to file backup. The removable media is fully compatible with the 9121D/S mass storage units. This mass storage system is an excellent match for the HP Series 80, 100 and 200 products. (The HP 85A supports only Option 004.)

9133XV Winchester/3½" Microfloppy Combination

This is a single volume 14.5 Mbyte Winchester combined with a 3½" microfloppy. It provides the user with the large mass storage capacity required for data acquisition, graphics and general accounting applications along with the personal I/O capabilities of the microfloppy. This mass storage system extends the performance of selected 100 and 200 Series computers and is ideal for use on the HP 1000 A-Series.

9134XV 14.5 Mbyte Winchester

This Winchester offers 14.5 Mbytes formatted capacity with fast 146 msec average access time and 50 Kbytes maximum transfer speed depending on mainframe capability. It is designed for use with Series 200 and 1000 A Series computers.

Ordering Information for New Winchester Drives

- 9133V 4.6 Mbyte Winchester/3½" microfloppy
- Option 010 Single Volume 4.8 Mbyte
- 9133XV 14.5 Mbyte Winchester/3½" microfloppy
- 9134XV 14.5 Mbyte Winchester
- 92191A HP Qualified 3½" Media (Box of 10)

HP Mainframe Support Table

	82901/2	9895A	9121D/S	9134XV	9133V	9133XV
Personal Computers Series 80, 100	•	•	•	★★	•	★★
Desktop Computers 9816, 9826, 9836	•	•	•	•	•	•
Desktop Computers 9825T, 9845C		•				
Minicomputers 1000 L Series Model 5, 6		•		•	•	
Minicomputers 1000 M, E, F		•	•			
Minicomputers 1000 A Series A600, A700, A900		•	•	•	•	•
Business Computers 3000 Series		•				

★★ = HP 150 only



COMPUTERS, PERIPHERALS & CALCULATORS

MAC Disc Drive Family

Models 7906, 7920, 7925

- Performance
- Reliability
- Serviceability

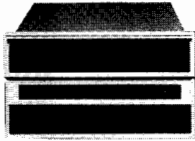

7906MR/SR

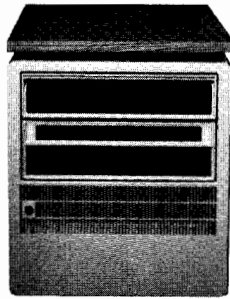

7906M/S

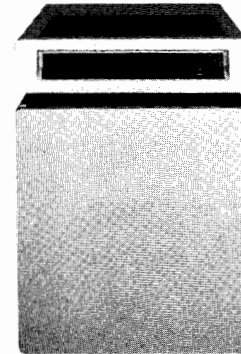

7920M/S, 7925M/S

The Hewlett-Packard Multi-Access Controller (MAC) Disc Drive family offers a wide range of reliable, high-performance mass storage capabilities. Engineering and manufacturing excellence have been emphasized in the HP tradition to insure that the entire disc drive family exhibits the performance, reliability, and serviceability that have established HP products as a marketplace standard.

Features

- Configuration flexibility from 20 Mbytes to 960 Mbytes of HP-formatted usable storage
- High-performance disc drives, 25 ms average seek times
- Sophisticated microprocessor-based disc controller
- Systems engineered for optimum performance with HP computing systems
- Designed and manufactured for exceptional performance and reliability over a wide range of environments
- World-wide service and support

Description

Hewlett-Packard offers a complete line of controller-compatible disc drives for the minicomputer industry. The Multi-Access Controller (MAC) Disc Drive family is comprised of three high-performance disc drives: the 120 Mbyte 7925, the 50 Mbyte 7920 and the 20-Mbyte 7906. These mass storage devices have been engineered and manufactured for reliability, performance and low cost of ownership.

The heart of the MAC Disc Drive family is a powerful Multi-Access Controller. Microprocessor-based architecture allows implementation of many sophisticated system features including access to as many as eight disc drives, extensive error correction, multi-CPU access, and automatic alternate track switching to name a few. Plug-to-plug compatibility across the entire family of disc drives permits up to eight 7906, 7920, or 7925 disc drives, in any combination, to be connected to a single controller. These features allow unmatched flexibility in configuring disc-based systems from 20 Mbytes to 960 Mbytes of HP-formatted user storage capacity.

7906 Cartridge Type Disc Drive

19.6 Mbytes formatted capacity: the 7906 disc drive features 9.8 Mbytes of removable and 9.8 Mbytes of fixed media to provide single-drive users with a convenient backup capability. The cartridge type media is exceptionally easy to store, use, and/or transport.

7920 Pack Type Disc Drive

50 Mbytes formatted capacity: the 7920 Disc Drive is a proven performer in the medium-capacity range of the Hewlett-Packard Multi-Access Controller (MAC) family of disc drives. Dependable, rugged, and attractively styled, the 7920 Disc Drive is an excellent choice for applications where reliability and performance are critical.

7925 Pack Type Disc Drive

120 Mbytes formatted capacity: each 7925 removable pack type drive provides 120 Mbytes of formatted storage capacity, which means a total of 960 Mbytes (0.960 gigabytes) would be available using eight 7925 drives on a single Multi-Access Controller.

Configuration

MAC—The maximum configuration for MAC Family disc drives is eight 7906 and/or 7920 and/or 7925 drives per controller. All cabling between Master and Slave drives is included.

Electromagnetic Emissions/Safety

The 7906, 7920, and 7925 are designed to meet FCC Docket 20780 for Class A computing devices. For Europe, they are designed to meet VDE 0871 for Level A computing devices and are FTZ licensed on some HP systems.

Products meet all applicable safety standards of the following: CSA 22.2 No. 154, IEC 380 and 435, UL 114 and 478.

Ordering Information

79XXM Master Drive (includes Multi-Access Controller)

79XXS Slave Drive (Add-on disc drive with 79XXM)

7906XR Rack Mountable unit

Drive	Controller Included?	Max Power@ 120 V, 60 Hz	Media	Available Options
7906M	Yes	740W/8.0A	12940A	015,102
7906MR	Yes	720W/7.8A	12940A	015,020,025,102
7906S	No	520W/5.7A	12940A	015
7906SR	No	500W/5.5A	12940A	015,020,025
7920M	Yes	700W/7.4A	13394A	015,102
7920S	No	480W/5.1A	13394A	001,015
7925M	Yes	630W/6.7A	13356A	015,102
7925S	No	410W/4.4A	13356A	001,015,250
7925T	No	410W/4.4A (each drive)	13356A	001,015,250

Options:

001 Changes cable lengths. (Substitutes 5.5 m (18 ft.) Multi-Unit and 7.8 m (25 ft.) data cables for standard lengths)

015 230 V/50 Hz operation

020 Substitutes 30 inch rack slide kit

025 Substitutes rack slide kit and prefilter assembly for mounting in a 29431F cabinet

102 Adds HP-IB adapter kit

250 Adds controller upgrade service required to support the first 7925S added to our existing MAC subsystem (may include the use and/or exchange of refurbished printed circuit assemblies)

COMPUTERS, PERIPHERALS & CALCULATORS

CS/80 Disc Drive Family

Models 7908, 7911, 7912, 7914, 7933, 7935

621



- Performance
- Reliability
- Serviceability

- Integral self test and diagnostics
- Internal microprocessor controller

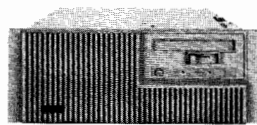
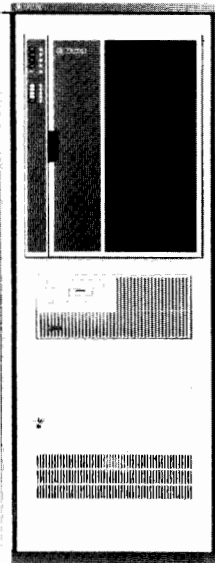

7908R

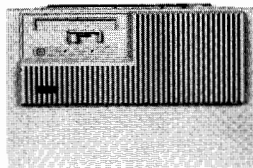

7911R, 7912R, 7914R

7914TD

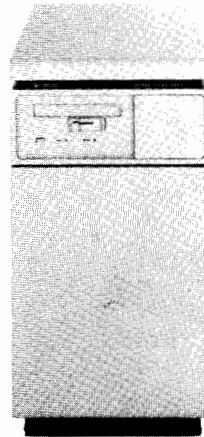

7933H,
7935H

7908P,
7911P,
7912P,
7914P

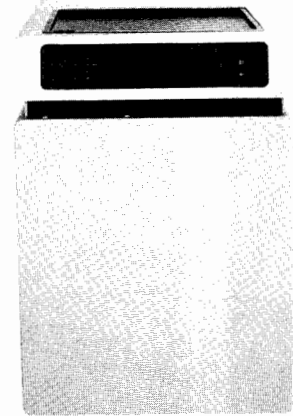

exceptionally low maintenance costs of this product. A bundled package of three 7933H's is available as the 7933G at a reduced price.

7935H Disc Drive

The 7935H Disc Drive is a removable media device that provides 404 Mbytes of removable media for increased system flexibility and greater system uptime for private data volume configurations and disc-to-disc backup/restore operations.

Operating Characteristics

Electromagnetic Emissions

The 7908, 7911, 7912, 7914, 7933, and 7935 are designed to meet FCC Docket 20780 for Class A computing devices. For Europe, they are designed to meet VDE 0871 for Level A computing devices and are FTZ licensed on some HP systems.

Safety

The 7908, 7911, 7912, 7914, 7933, and 7935 meet all applicable safety standards of the following: CSA 22.2 No. 154, IEC 380 and 435, UL 114 and UL 478.

Ordering Information

7908P/R (16.5 Mbytes)

7911P/R (28.1 Mbytes)

7912P/R (65.6 Mbytes)

7914P/R (132.1 Mbytes)

Opt 001: Dedicated tape controller (7911, 7912, and 7914 on HP3000 only)

Opt 015: 220-volt operation

Opt 140: Delete cartridge tape drive

7914TD (132.1 Mbytes)

Opt 002: Adds cartridge tape drive and second controller (for HP3000 only)

Opt 015: 220-volt operation

Opt 114: Adds second 7914R (less cartridge tape drive)

Opt 236: Configures 7970E with parallel interface (for HP1000 E-and F-Series)

Opt 240: Adds cartridge tape drive to first 7914R

7933H (404 Mbytes)

7933G (1.212 Gbytes)

7935H (404 Mbytes)

Standard Input Power: 208 volts

Opt 120: For 120-volt operation in U.S.A., Canada

Opt 220: For 220-volt operation in Canada

Opt 221: For 220-volt operation in continental Europe

Opt 222: For 220-volt operation in Switzerland

Opt 223: For 220-volt operation in Denmark

Opt 241: For 240-volt operation in United Kingdom

Opt 242: For 240-volt operation in Australia, New Zealand

Creating new standards for efficiency and ease of use, Hewlett-Packard offers the 7908, 7911, 7912, 7914, 7933, and 7935 disc products. Whether you require an efficient entry level product or a larger, more powerful solution, these disc products are designed to satisfy your particular storage requirements.

To ensure flexibility in configuring mass storage needs, each disc product employs the same efficient command structure (CS/80) and the same interface standard (HP-IB), allowing you to mix and match a wide range of compatible storage solutions with little or no need for additional control hardware or software modification.

All of the CS/80 family disc products contain a sophisticated, internal controller which performs advanced, self-diagnostic routines to facilitate maintenance and servicing. These self-diagnostic capabilities, coupled with careful design and engineering, promote a highly reliable and serviceable disc drive which will provide greater system uptime and productivity.

7908, 7911, 7912, 7914 Disc/Tape Drives

These Disc/Tape Drives are a family of products designed to satisfy all peripheral storage requirements in a single compact package. Each product utilizes a unique integrated storage concept, featuring a reliable Winchester disc mechanism for mass storage, and a ¼-inch cartridge tape drive for backup and user I/O.

The product line provides mass storage capacities from 16.5 to 132.1 Mbytes; they include the 7908 (16.5 Mbytes), 7911 (28.1 Mbytes), 7912 (65.6 Mbytes), and 7914 (132.1 Mbytes).

7914TD Mass Storage Subsystem

The 7914TD is a complete mass storage subsystem that includes a 7914R Disc Drive (less cartridge tape drive) and an HP7970E ½-inch, 1600 bpi magnetic tape drive mounted in a 63-inch cabinet. Option 114 adds a second 7914R for a total of 264.2 Mbytes in a single cabinet.

7933H Disc Drive

The 7933H Disc Drive is a fixed media device that provides high levels of performance, reliability, and serviceability. The performance of the 7933H promotes overall greater system efficiency. The advanced reliability and serviceability features are reflected by the



COMPUTERS, PERIPHERALS & CALCULATORS

Workstation Printers

Models 2601A, 2602A, 8290

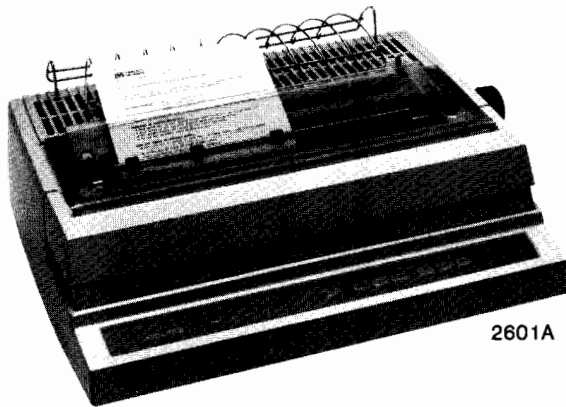

2601A

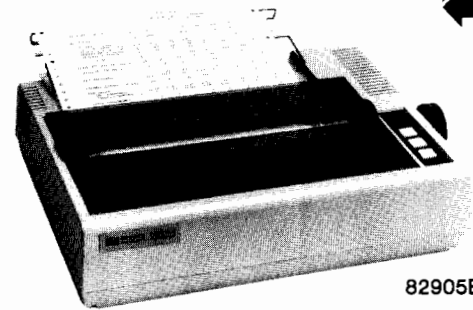

82905B



Introduction to Workstation Printers

Hewlett-Packard's workstation printers provide the convenience of hard copy output right where it is needed: at the user's work area.

HP's workstation printers offer a broad range of capabilities combining high performance and easy-to-use features to suit a variety of applications. A simple comparison will help you to determine the right workstation printers for your applications.

Word Processing Printers and Accessories

Through the use of full-font characters, HP's word processing printers assure professional-looking copies of text. Whether used in word processing systems, or as general-purpose printers, the HP 2601A and 2602A Daisywheel Printers produce customized output with a minimum of operator interaction.

The HP 2601A and 2602A Daisywheel Printers

- Letter-Quality Output for Single-User and Shared-Printing Applications
- Comprehensive Selection of Printwheels
- Tractor Feed and Sheet Feeder Accessories
- Accommodates Paper Widths up to 15.25"

The 2601A and 2602A Daisywheel Printers offer excellent print quality and similar capabilities for high and low-end word processing requirements. Both printers feature proportional spacing, bold and shadow printing, and underlining. The 25-cps 2602A suits low-volume, single-user printing applications, while the 40-cps 2601A meets shared and higher-volume printing requirements. Both deliver attractive, accurate letters, memoranda, multipart forms and reports.

General Purpose Printers

HP's general purpose printers include a range of non-impact as well as impact printers. The non-impact thermal printers offer quick, quiet printing. The impact printers offer both permanent copy and multipart forms capability. The general purpose printers feature dot matrix character formation and most of these printers also feature graphics capabilities.

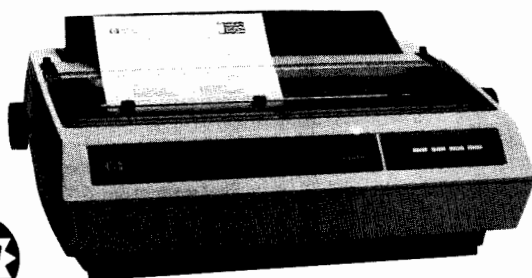

2602A

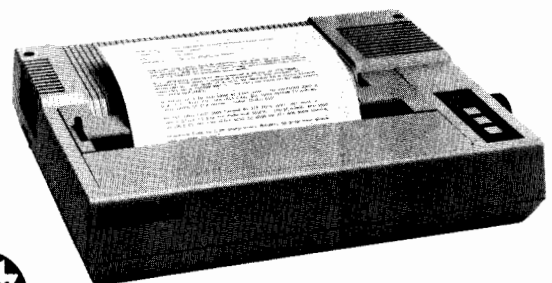

82906A



The HP 82905B Graphics Printer

- 80-cps Bidirectional Printing
- 9 x 9 Dot Matrix Character Cell
- 72 x 60 or 72 x 120 Dot-Addressable Graphics
- Centronics Parallel/RS232/HP-IL Option

This truly compact 80-column printer features compressed and expanded print modes with 5, 8.25, 10, and 16.5 characters per inch. User-selectable features include variable line spacing, bold print, and perforation-skip mode.

The HP 82906A Graphics Printer

- 160-cps Bidirectional Printing
- 9 x 11 Dot Matrix Character Cell
- 72 Dots-Per-Inch Raster Graphics
- Last Form Tear-Off

The 82906A offers extensive forms handling features. In addition to raster graphics, its printing capabilities include six print pitches (printing up to 131 characters per 8" line), proportional spacing, bold printing, underlining, superscripts, and user-definable character sets. An optional tractor feed accommodates forms from 4" to 9.5" wide.

COMPUTERS, PERIPHERALS & CALCULATORS

Workstation Printers

Models 2932A, 2635B, 2673A, 9876A

623

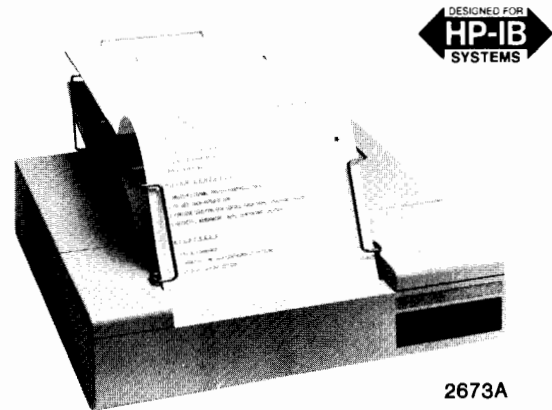
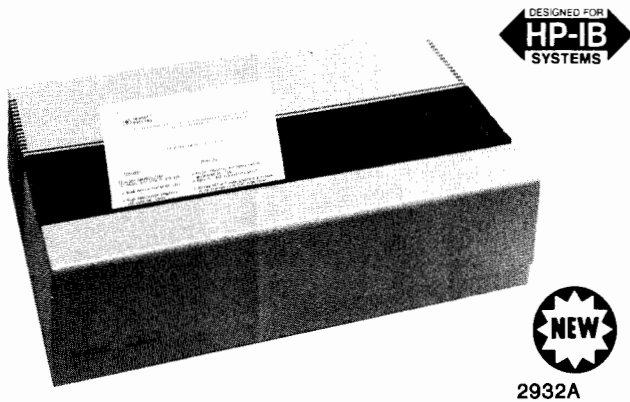

The HP 2932A Impact Printer

- 200-cps Bidirectional Printing
- 9 × 12 Character Cell
- 90 Dots-Per-Inch Raster Graphics
- Last Form Tear-Off and Straight Paper Path

The 2932A offers quiet, low-cost, 136-column printing. Simplicity of operation, graphics capability, and a strong set of transaction and technical printing features allow the HP 2932A to meet most single-user and distributed printing needs. A friendly, front control panel makes feature selection a simple matter with nine resident languages, two fonts (serif and sans serif), selectable print pitches, line spacings, and margins from which to choose.

The HP 2635B Printing Terminal

The 2635B is a 180-cps printing terminal that provides printing for remote program development, forms completion, and other on-line printing applications via an RS-232C interface. The typewriter-style keyboard includes a numeric keypad for easy data entry. There are twelve configuration keys for easy access to printing features.

The HP 2670 Series Thermal Printers

- 120-cps Bidirectional Printing
- 9 × 15 Dot Matrix Character Cell
- Interface Flexibility: HP-IB, RS-232C, HP or Centronics Parallel, Factory Data Link, HP-IL
- Fanfold or Roll Paper

The HP 2671A Alphanumeric Printer

The 2671A offers fast, quiet convenience printing for business or home. It features the full 128 USASCII, Roman Extension, and line drawing character sets. An ideal desktop printer for terminals, desktop computers, personal computers, or test systems, it generates copies of text pages, program output, or test results.

The HP 2671G Graphics Printer

The 2671G has 90-dots-per-inch raster graphics capability in addition to all the features of the HP 2671A.

The HP 2673A Intelligent Graphics Printer

The 2673A includes all the features of the 2671G, plus autocentering, windowing, offsets, expanded characters 5 cpi, high density printing, and framing. The 2673A also features JASCII, HPL, Katakana, and nine ISO languages.

Print features and formatting are selected via the control panel, and stored in the printer's nonvolatile memory. Once selected, features come up automatically at printer power-on. Escape sequence commands from the host turn features on or off without altering the setting in the memory.

The HP 2674A Internal Printer

The user-installable 2674A Printer for HP 150 users is the lowest cost printer available from HP. The space-saving 2674A offers fast text and graphics and helps preserve quiet in your work area.

The HP 9876A Thermal Graphics Line Printer

The 9876A offers fast, quiet line printing at 480 lines per minute. It is ideal for producing high-speed listings, working reports or quick plots and graphics. Featuring HP-IB, 8-bit parallel, and RS-232C interface options, the 9876A is compatible with a wide variety of computers and terminals.

Ordering Information

2601A Daisywheel Printer
26010D Cut Sheet Feeder
2602A Daisywheel Printer
2671A Thermal Printer
2671G Thermal Printer
2673A Thermal Printer
2674A Internal Printer
2932A Impact Printer
82905B Impact Printer
82906A Impact Printer
9876A Thermal Printer

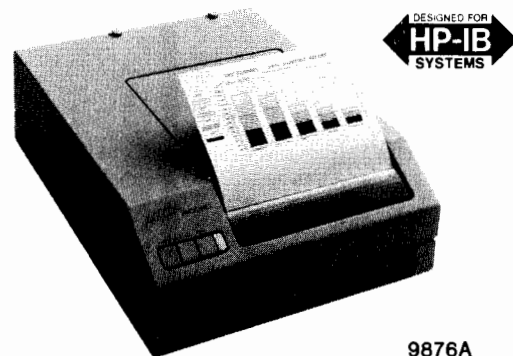



COMPUTERS, PERIPHERALS & CALCULATORS

Line Printer, Laser Printing System

Model 2563A Model 2680 Models 2687A,2688A

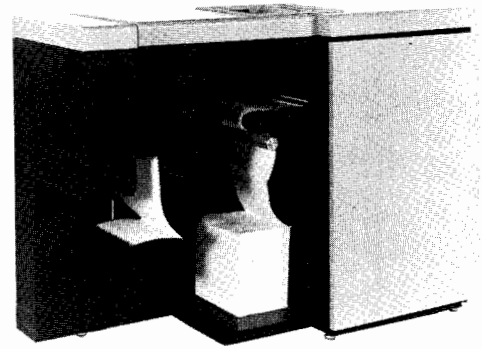

2680

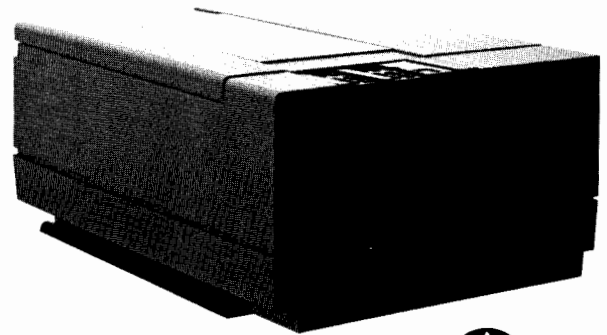

2563A



HP 2563A Line Printer

The Series 300LP Model 2563A is a reliable, medium speed, dot matrix line printer designed for use in most computer printing applications. Printing at 300 lines-per-minute in the standard mode and 150 lpm in the high density mode, the 2563A offers many user features such as graphics, bar code printing, multiple character sets, 16-channel vertical format control, high density printing and double-size characters.

Printing versatility: the HP 2563A prints crisp, clear, dot matrix characters using a line matrix technology. This provides the flexibility to select:

- Character definitions for multiple languages, line drawing and special characters
- Character size and font
- Graphics
- Normal or high density print

Reliability: the printing mechanism in the 2563A has few moving parts, operates virtually without friction and requires a minimum amount of maintenance. The microprocessor control of the printer provides for increased functional capabilities and added reliability.

Remote serial interface: optional serial interfaces allow the 2563A to operate remotely using modems or long cables running HP multi-point software or RS-232 connections on HP 3000 computer systems.

HP 2563A Line Printer

HP 2687A / 2688A Page Printers

The HP Series 1200 Models 2687A and 2688A page printers are medium speed, low- to medium print volume laser electrophotographic printers. These printers are ideally suited for applications requiring high print quality such as letters, reports and documents. The maximum print speed of 12 pages-per-minute and their quiet operation make them excellent alternatives to daisy wheel, impact matrix, thermal, or electrostatic printing technologies for many applications.

High print quality: the high resolution (300 dots/inch) of the 2687A coupled with the high contrast of the electrophotographic process,

yields excellent quality print. Paper utilized is single "cut" sheet 8.5 by 11 inches or A4 European size. The input/output hoppers can hold up to 250 sheets.

Merged text and graphics printing: the 2688A is differentiated from the 2687A by its ability to print merged text and graphics on the same page. Operating in conjunction with the HP 3000 computer system and its associated graphics and word processing software packages, graphics and other diagrams may be automatically merged into textual material and printed.

Quiet operation: operating at under 55 dBA makes these printers ideally suited for engineering and office environments where excessive noise can be a major distraction.

HP 2687A Page Printer

HP 2688A Page Printer

HP 2680 Laser Printing System

The 2680 Laser Printing System (LPS) combines the 2680A Laser Printer and several optional application packages. The printer operates at 45 pages-per-minute on plain 8.5-inch by 11-inch fanfold paper. It features continuous paper feed for paper handling reliability, non-contact fusing which is virtually maintenance free and a data control system that is capable of handling variable size characters, electronic forms and multiple pages of print on one sheet of paper. In addition to these features, the 2680 LPS is equipped to operate with the following HP 3000 options:

Interactive design system: the IDS/3000 is used to design characters, symbols and forms using a graphics terminal. This includes digitization of artwork, including signatures.

Interactive formatting system: the IFS/3000 is used to specify page sizing and formatting, and to select forms and character fonts for a print job.

An optional graphics capability enables graphical data to be merged with text and printed by utilizing a software option on the HP 3000 and a hardware modification on the 2680. This eliminates manual cut-and-paste for text and graphics manipulation.

HP 2680 Laser Printing System

COMPUTERS, PERIPHERALS & CALCULATORS

625

Dial-Up Modems



Models 37213A/4A/5A/6A, 37222A, 37212A

- Auto-dial and auto-answer
- Automatic data-rate recognition and configuration
- Full duplex 1200 b/s and 300 b/s on dial-up lines

- Compatible with Bell 212A and CCITT V.22
- Central site, Integral and Stand Alone versions
- Local analog and remote digital loopback

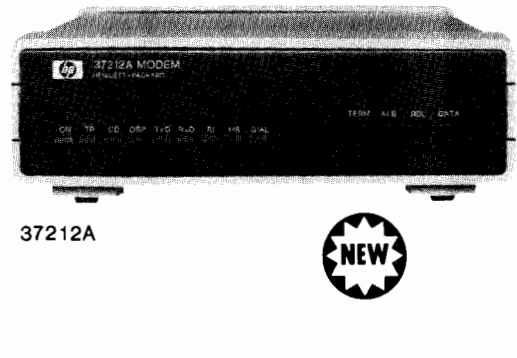
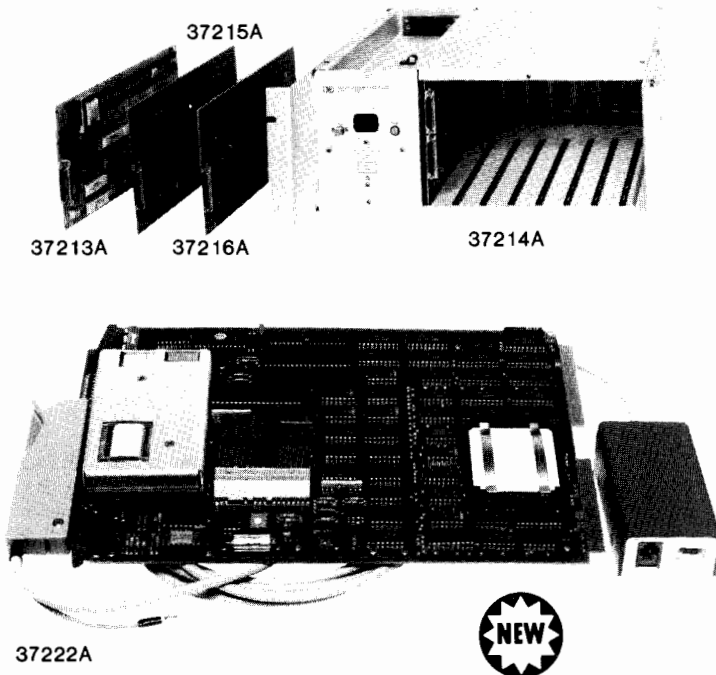

Introduction to Dial-Up Modems

It is becoming increasingly popular for computer systems to be used for distributed processing and the remote acquisition of financial and scientific data. To facilitate this requirement, HP now provides a family of Dial-up Modems primarily for use with HP 1000 Computer Systems. HP Dial-up Modems are designed for full duplex operation on dial-up lines over the public switched telephone system at speeds of 1200 and 300 bits per second.

Automated Features

In order to benefit from completely unattended operation, a modem must form an integral part of the user's HP 1000 Computer System. This is accomplished by providing auto-dial, auto-answer and automatic data-rate recognition and configuration in all HP dial-up modems, plus full user program control in the 37213A/4A/5A/6A Systems Modem and 37222A Integral Modem.

Which Modem Should You Use?

The Systems Modem has been designed for HP 1000 A/L and M/E/F-Series Computers, and can communicate both synchronously or asynchronously. The Integral Modem is designed only for HP 1000 A/L-Series Computers, and can only communicate in the asynchronous mode. The Integral Modem will, however, provide the most cost effective solution for HP 1000 A/L-Series users who require only a few modems. The Systems Modem is ideal for larger systems, and for applications where the number of I/O slots in the Computer is limited. For remote sites where no HP 1000 Computer exists, the 37212A Stand Alone Modem is the perfect solution.

37213A/4A/5A/6A Systems Modem

The Systems Modem is designed for use with all HP 1000 Comput-

ers and communicates with the Computer through an 8-channel Multiplexer (12040B in A/L-Series or 12792B in M/E/F-Series) and a single multiway cable.

37214A Modem Interface Card Cage

The Systems Modem is based on the 37214A Card Cage. This has space for up to seven modem or other interface cards in any combination. The eighth slot of the Card Cage is reserved for use by the integral controller and dialer which communicates with the user program by simulating an interactive display terminal. The controller and dialer provide the control signals, the pulse and DTMF dialing control, and loopback control for up to seven modem cards. Local analog loopback or remote digital loopback may be selected under program control to allow a user program to pass data and to check the integrity of the looped modem link. Also a local diagnostic terminal port enables monitoring of all the modem interface lines for diagnostic purposes.

37213A Modem Card

The 37213A is a single card modem. As with the 37215A/6A, it plugs into the 37214A Card Cage. It communicates with Bell 212A compatible modems at 1200 or 300 b/s and with any CCITT V.22 (Alternatives A and B) compatible modem at 1200 b/s. Asynchronous or synchronous communication is supported. The 37213A is also compatible with the Vadic 3450 Series Triple Modem. The Modem can perform both pulse and DTMF (tone) dialing under user program control. Two interfaces are provided; one for the 8-channel Multiplexer, and one for an RS232C port for applications that either do not use a Multiplexer, or when synchronous communication is required. Local analog or remote digital loopback may be performed under user program control.

COMPUTERS, PERIPHERALS & CALCULATORS

Short Haul Modem

Model 37230A

37215A Modem Interface Card

For applications where a PTT supplied modem must be used or where a modem is already available, a 37215A Modem Interface Card may be used in place of a 37213A Modem Card. The 37215A provides buffered RS232C and V.24/V.28 compatible lines for controlling all common switched line, full-duplex modems. Loopback of most external modems may be performed under user program control. The Modem Interface Card also provides auto-configuration of port speed with auto-answer modems. Auto-dialing is not possible when using external modems.

37216A Terminal Interface Card

The 37216A allows direct connection of local interactive display terminals to unused Multiplexer ports. With the Terminal Interface Card, one local terminal can be connected to one port of the 8-channel Multiplexer via a standard 25-pin D-type connector.

37222A Integral Modem

The 37222A Integral Modem offers virtually identical functions to the 37213A/4A Systems Modem. However, it is a completely self-contained Modem built into an A-Series interface card. Designed for use in HP 1000 A/L-Series Computers, this card plugs directly into the Computer. This Modem is the first of its kind (from Hewlett-Packard) to offer its users a direct connection from the CPU to an external phone line. The 37222A is software-compatible with the 37213A/4A Systems Modem, so applications software developed for use with the 37213A/4A may be used with the 37222A.

The Modem is compatible with Bell 212A type modems and CCITT V.22 (Alternative B) type modems, but unlike the Systems Modem, will only support asynchronous communications. All other functions offered by the 37213A/4A Systems Modem are also supported by the 37222A Integral Modem. HP 1000 M/E/F-Series Computers must use the 37213A/4A Systems Modem.

37212A Stand Alone Modem

The 37212A is an "intelligent" Stand Alone Modem incorporating a microprocessor to provide modem control and auto-dial facilities for HP interactive display terminals, calculators and computers which do not support switched line modems via RS232C/V.24. The Modem is fully Bell 212A compatible at 300 or 1200 b/s and CCITT V.22 compatible at 1200 b/s for use in some European countries. Either synchronous or asynchronous communication can be conducted. The Stand Alone Modem can support the same automatic functions as the other members of the Dial-up Modem family. Commands are passed from a terminal or computer through the RS232C/V.24 interface (using secondary TxD as an asynchronous command channel in the case of synchronous operation).

In addition to the commands available through the interface, the 37212A can also conduct local analog and remote digital loopbacks from the front panel. Non-volatile storage is provided for Modem configuration and for ten 22-character strings which can be used for telephone numbers and log-on sequences. The strings can be linked together to provide completely automatic connection and log-on. A telephone is not required, but a second telephone connector is provided on the rear panel to allow one to be connected in parallel with the Modem. The Modem contains an integral power supply for ac operation, and also can operate from a dc supply where ac power is unavailable, eg telecoms and medical applications.

Ordering Information

- 37213A Modem Card
- 37214A Modem Interface Card Cage
- 37215A Modem Interface Card
- 37216A Terminal Interface Card
- 37222A Integral Modem
- 37212A Stand Alone Modem

37230A

- Short Haul Modem for 2- or 4-wire operation
- Point-to-point or multi-drop
- Synchronous data rates to 19.2 kb/s, asynchronous to 4.8 kb/s



37230A

37230A Short Haul Modem

The 37230A Short Haul Modem provides synchronous transmission of data at rates of 2.4, 4.8, 9.6, and 19.2 kb/s. The unit is designed for half-duplex, full-duplex, and multi-drop operation over local circuits. It offers features similar to those of a conventional modem, but at lower cost. The 37230A is an economic alternative where transmission within a limited area is required.

The modem can be used over unloaded metallic circuits which are either installed privately or leased from the telephone company. The modem operates half-duplex on 2-wire circuits, and half-duplex, full-duplex, and multi-drop on 4-wire circuits. Suitable circuits can normally be obtained from the telephone company but may be restricted to within one end office (exchange) area. The 37230A complies with BSTR Pub 43401 and is also designed to meet the technical requirements of other authorities including many European PTT's.

An automatic equaliser in the modem receiver compensates for variable characteristics of the telephone circuit, optimising the performance throughout the specified range. In multi-drop systems the central modem automatically readjusts its equaliser to compensate for whichever of the remote sites is transmitting.

The 37230A includes diagnostic test features similar to those found on conventional leased line modems. These include local and remote digital loopback, local analog loopback, and a test pattern generator/error detector.

Range

The operating range of the 37230A depends on several factors including data rate, transmit signal level, and cable type used for the circuit. Typical operating ranges are shown in Table 1.

To meet the requirements of BSTR Pub 43401, the output level from the modem must be reduced for data rates above 2.4 kb/s. The required reduction in send level causes a corresponding reduction in range.

Table 1 Operating Range (max output level)

Data Rate	19 AWG 0.9mm	22 AWG 0.6mm	24 AWG 0.5mm	26 AWG 0.4mm
2.4 kb/s	22 miles	15 miles	12 miles	10 miles
4.8 kb/s	18 miles	12 miles	10 miles	8 miles
9.6 kb/s	13 miles	9 miles	7 miles	6 miles
19.2 kb/s	9 miles	6.5 miles	5 miles	4 miles

Note: test conditions: maximum send level; 140Ω terminating impedance; polythene insulated twisted pair cable simulator.

37230A Short Haul Modem

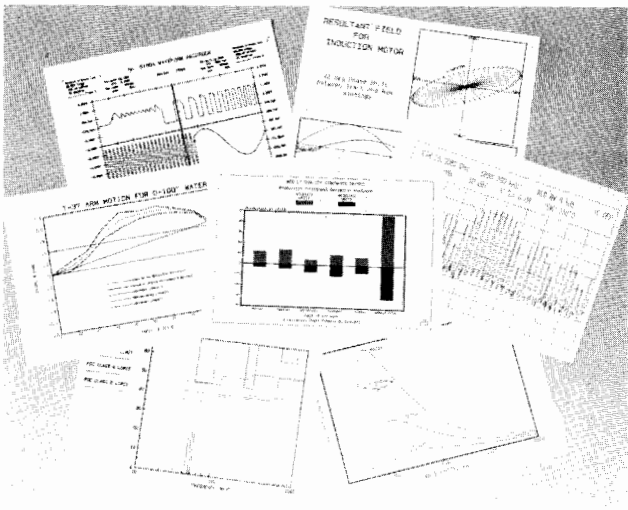

In fields as diverse as engineering, chemistry, medicine, finance, and marketing, the need for hardcopy graphics is growing. The reason is simple: graphics provide a comprehensive, easy-to-understand overview of numerical data. With Hewlett-Packard plotters, you can quickly generate professional, hardcopy graphs and charts from design, measurement, and computational data.

Choice of Interfaces and Instruction Sets

There are three interfaces for connecting HP plotters with HP and non-HP computers: the HP-IB (IEEE-488-1978), the RS-232-C/CCITT V.24, and the new HP-IL. See the table below for the interfaces available with each plotter.

HP plotters understand one of two graphics instruction sets to provide an efficient communications method for your application. Most understand HP-GL (Hewlett-Packard Graphics Language), a set of easy-to-remember mnemonic commands for controlling machine

functions such as pen movement, character generation, and axis production. Compacted binary instructions were written specifically for the 7221 plotter, which is designed for remote operation with low baud modems where transmission efficiency is of critical importance.

Graphics Software

To make plot generation as effortless as possible, HP offers a graphics software package which can be used with any plotter with RS-232-C/CCITT V.24 or HP-IB interfaces. The HP Industry Standard Plotting Package (HP-ISPP) is written entirely in ANSI Standard FORTRAN. It allows simple adaptation of existing application programs for use with HP plotters.

HP plotters are supported on a number of Hewlett-Packard computer systems, desktop computers, and intelligent terminals. This support includes a wide range of graphics application software packages.

Plotting Media and Pen Choices

Each HP plotter uses paper and at least one additional medium: plots can be made on transparency film for overhead projection, or on vellum, double-matte polyester film, and tracing bond for engineering and drafting drawings.

HP plotter pens include three types, fiber-tip, roller-ball, and liquid ink drafting pens. The fiber-tip pens for both paper and transparencies come in two tip widths, a fine tip for grids, tick marks and labels, and a wide tip for bold titles, heavy lines, and filled-in areas. For engineering and drafting media, refillable drafting pens come in six standard widths, roller-ball pens in one width and four colors. The table below indicates the media and pen types which can be used with each plotter.

Intelligent Pen Control

All HP plotters change pens automatically under program control so no operator intervention is necessary. To produce graphics of consistently high quality, HP plotters precisely control pen movements through the use of sophisticated electronic circuitry. As pens descend, their motion is automatically damped to preserve pen tips. When pens are returned to their stalls after use, they are automatically capped so they stay fresh and last longer.

Plotter Description	Media	Media Size	Model No.	Interface	Page
High-quality plotters for budget-sensitive applications. Two-pen (7470A) or six-pen (7475A) programmable. Use fiber-tipped pens.	Paper or transparency film	210 x 297 mm (8.5 x 11 in.)	7470A Option 001	RS-232-C/ CCITT V.24	628
			7470A Option 002	HP-IB (IEEE-488)	
			7470A Option 003	HP-IL	
		210 x 297 mm (8.5 x 11 in.) and 297 x 420 mm (11 x 17 in.)	7475A Option 001	RS-232-C/ CCITT V.24	628
7475A Option 002	HP-IB (IEEE-488)				
8-pen flatbed plotters with automatic paper advance for unattended operation. Compacted binary language in 7221T. Use fiber-tip and drafting pens.	Paper, transparency film, vellum, double-matte polyester film	Any size up to 297 x 420 mm (11 x 17 in.)	7220T	RS-232-C/ CCITT V.24	630
			7221T		
			9872T	HP-IB (IEEE-488)	630
High-speed, high resolution 8-pen drafting plotters for large-format applications. Excellent price/performance advantage. Use fiber-tip, roller ball, and drafting-pens.	Paper, tracing bond, vellum, double-matte polyester film	Maximum: 622 x 1231.9 mm (24.5 x 48.5 in.) Minimum: 203 x 267 mm (8 x 10.5 in.)	7580B	RS-232-C/ CCITT V.24 and HP-IB (IEEE-488)	632
		Maximum: 927 x 1231.9 mm (36.5 x 48.5 in.) Minimum: 203 x 267 mm (8 x 10.5 in.)	7585B	RS-232-C/ CCITT V.24 and HP-IB (IEEE-488)	632

COMPUTERS, PERIPHERALS & CALCULATORS

Graphics Plotters

Models 7470A and 7475A

- Low cost, high performance
- Choice of six- or two-pen models
- Plots on paper
- Plots on HP overhead transparency film

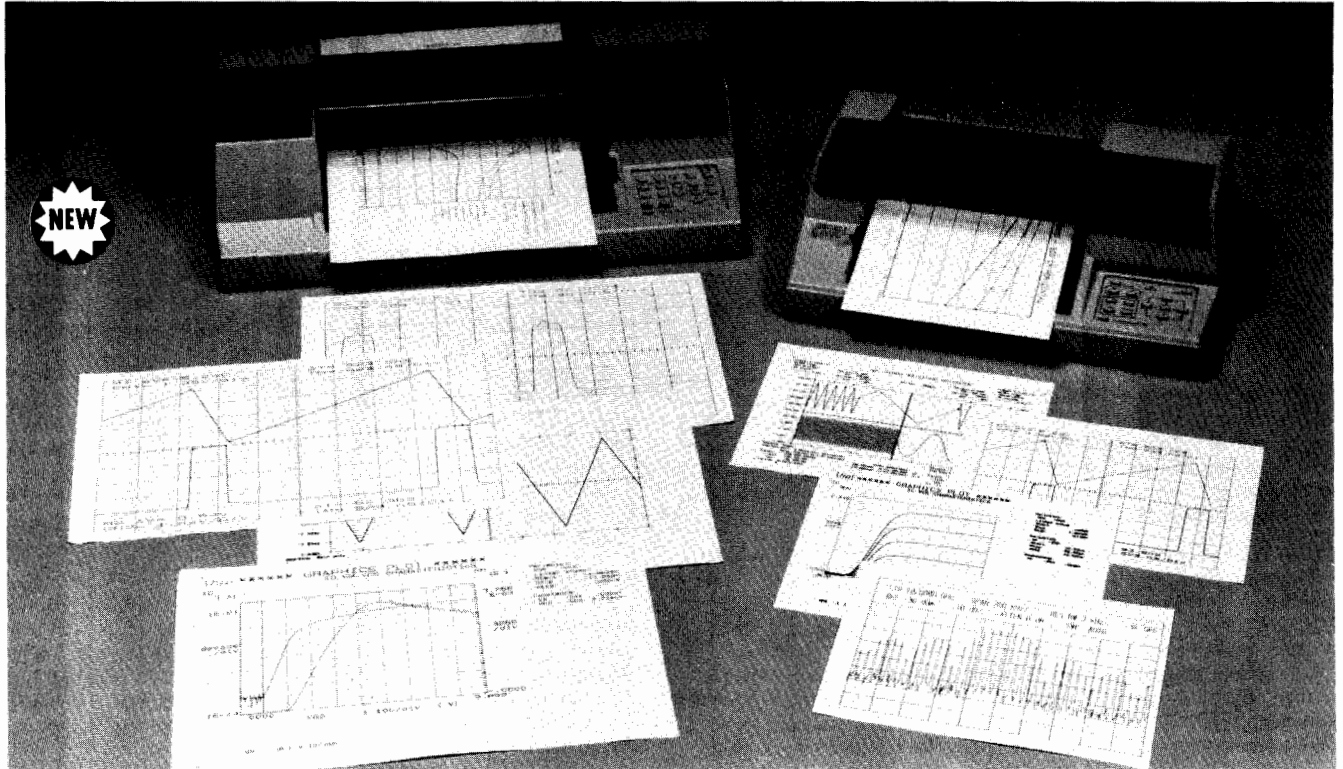

Hewlett-Packard's 7470A and new 7475A graphics plotters provide the kind of graphics excellence you would expect to find only in much more expensive plotters. They feature the same high-quality components and innovative paper-moving technology which were introduced in HP's drafting plotters and which make it possible to offer high performance plotters at affordable prices. Refer to the table below for a quick comparison of the main features available in each plotter.

Features	7475A	7470A
Media sizes	Two ANSI sizes: A (8.5 x 11 in.) and B (11 x 17 in.) Two ISO sizes: A4 (210 x 297 mm) and A3 (297 x 420 mm)	One ANSI size: A (8.5 x 11 in.) One ISO size: A4 (210 x 297 mm)
Pens	Six fiber-tip; programmable pen selection; automatic capping	Two fiber-tip; programmable pen selection; automatic capping
HP-GL instructions	More than 50 instructions	More than 40 instructions
Character sets	19 sets, including ISO European standards and Katakana	Five sets
Standard interfaces	HP-IB (IEEE 488-1978) or RS-232-C (CCITT V.24)	HP-IB (IEEE 488-1978) or RS-232-C (CCITT V.24) or HP-IL
	Each plotter incorporates one permanent interface option.	
Technology	Both plotters use the same micro-grip drive for paper movement and have the same high resolution, repeatability, and velocity.	

Measurement Applications

The 7470A and the 7475A add hardcopy graphics capability to intelligent instruments and instrument systems with HP-IB (IEEE 488-1978). For most applications that use a display screen and an oscilloscope camera, these plotters can produce high-quality hardcopy of the screen for a cost that is substantially lower than camera film. Because they plot directly from measured data, they eliminate problems created by distortion from the screen. And plotter output provides

better visual resolution than photographs. Many systems without screen displays can also have the benefits of 7470A or 7475A hardcopy graphics at very little additional cost.

Computer Applications

The 7470A and 7475A provide hardcopy computer graphics for technical, scientific, and business applications. Colorful A4/A-size charts and graphs are ideal for reports and overhead transparencies. Use them for summarizing data, identifying trends, comparing results, and focusing on exceptions. The larger A3/B-size plots that can be drawn on the 7475A are particularly useful for time lines, PERT charts, schematics, engineering drawings, and other applications where you need to show visual detail.

Easy to Use

When the 7475A or 7470A plotters are turned on, default conditions are automatically established for most plotting parameters. In many cases, it is only necessary to load the pens and plotting medium in order to start plotting.

Media and pen loading are also easy. A guide control lever makes media alignment perfect every time. The front panel can be used to select pens, to halt the program for exchanging pen colors, or to move the plot forward to "view" what you have plotted.

The front panel also allows easy access to the plotter's digitizing capability and scaling points. And, on the 7475A, push buttons can rotate plots 90 degrees or run a demonstration plot directly from the plotter.

Intelligence Features

Intelligence features are built directly into these plotters to save you time by eliminating the need for software-generated characters and functions. Many HP-GL instructions (more than 50 in the 7475A; more than 40 in the 7470A) govern such tasks as labeling, pen movement, drawing arcs and circles, and selecting from a large variety of



character sets. The 7475A has 19 character sets including ISO European sets, Katakana, ASCII, and Roman 8 extensions; the 7470A has five internal character sets.

The 7475A's extra HP-GL instructions, which are used for filling rectangles and wedges for pie and bar charts, provide an enhancement especially designed for professional graphics.

Writing Systems

The 7470A has two built-in pen stalls which make two-color plotting easy. For plots with more than two colors, the program can be halted through program or front panel control; new pens can then be installed and plotting resumed. The 7475A's six-pen carousel allows you to store up to six different pen colors or a variety of colors and widths.

Several automatic features are included to protect the tip of the pen and increase pen life. When housed in the stall or carousel, the pen is capped to prevent premature drying. When a pendown command is given, the pen force is damped and the pen is gently lowered to the plotting surface.

High-Quality Output

The 7470A and the 7475A have an addressable step size of 0.025

mm (0.001 in.). With this resolution, they can plot up to 1000 points in a 1-inch line. When commanded to return to the same point with no pen change, they achieve this repeatability within 0.1 mm (0.004 in.) Because of this outstanding resolution and repeatability, both plotters produce straight lines and smooth circles that have an artist-drawn appearance.

Interface Options

The 7475A and 7470A are easy to interface with most HP and non-HP computers. Both plotters offer the RS-232-C/CCITT V.24 or HP-IB (IEEE 488-1978) interface. With the RS-232-C option, a dual input/output cable is available for connecting the plotters with a terminal and computer. In addition, the 7470A offers a third interface option, HP-IL. This interface is used to connect the plotter with low-cost, portable HP systems.

Graphics Software

HP offers a full line of graphics software packages for use on most HP computer products. And software is also available for many non-HP computers. These packages make it easy for non-programmers to use the 7470A and 7475A plotters. Details are available from any HP sales and support office.

Specifications

	HP 7475A	HP 7470A
Resolution	Smallest addressable step size: 0.025 mm (0.001 in.)	
Repeatability	With a given pen: 0.1 mm (0.004 in.) From pen to pen: 0.2 mm (0.008 in.)	
Pen velocity (each axis)	Pen up, 50.8 cm/s (20 in./s); pen down, maximum — 38.1 cm/s (15 in./s), programmable — 1 to 38 cm/s in 1 cm/s increments	
Acceleration	Approximately 2 g's	
Environmental range	Operating, 0°C to 55°C Non-operating, -40°C to 75°C	
Plotting area		
X-axis	258 mm (10.2 in.), A/B 275 mm (10.8 in.), A4/A3	191 mm (7.5 in.) A 191 mm (7.5 in.), A4
Y-axis	198 mm (7.80 in.), A 192 mm (7.56 in.), A4 414 mm (16.3 in.), B 402 mm (15.8 in.), A3	257 mm (10.2 in.), A 272 mm (10.7 in.), A4
Interfaces	HP-IB (IEEE 488-1978), implements the following HP-IB functions as defined in IEEE 488-1978: SH1, AH1, T2, TE0, LEO, SR1, RLO, DC1, DT0, L2, PPO. (listen only or address less than 7, otherwise PP2)	
	RS-232-C/CCITT, asynchronous serial ASCII with switch selectable baud rates of 75, 110, 150, 200, 300, 600, 1200, 2400, 4800, 9600. External clock input capabilities with intermediate baud rates of up to 9600 baud. 1024 byte buffer.	Same as 7475A except 255 byte buffer.
		HP-IL, Hewlett-Packard Interface Loop for use with portable systems.
Power Requirements	Source: 100, 120, 200, 240 V ~ -10%, +5% Frequency: 48-66 Hz	
	Consumption: 35 W maximum	Consumption: 25 W maximum
Size:		
Height	127 mm (5 in.)	127 mm (5 in.)
Width	568 mm (22.4 in.)	432 mm (17 in.)
Depth	367 mm (14.5 in.)	343 mm (13.5 in.)
Weight:		
Net	7 kg (16.0 lb)	6 kg (13.5 lb)
Shipping	Approx. 11 kg (25.0 lb)	Approx. 10 kg (22.0 lb)
FCC	FCC certified to conform to limits set for radio frequency interference when used with a Class B computing device.	

Accessories Supplied

HP 7475A

- 07475-90001 Interfacing and Programming Manual
- 07475-90002 Operation and Interconnection Manual
- 07475-90004 Reference Card

HP 7470A

- 07470-90001 Interfacing and Programming Manual
- 07470-90002 Operator's Manual
- 07470-90003 Interconnection Guide
- 07470-90004 Reference Card

Power cords and an assortment of pens and drawing media are also supplied with the plotters. The media size and the appropriate power cord are determined by plotter destination. The HP-IL cable (½-metre) is supplied with Option 003 only.

Ordering Information

Options

- 001 RS-232-C/CCITT V.24 (cable not included)
- 002 HP-IB (IEEE 488-1978) (cable not included)
- 003 HP-IL for 7470A only (cable included)

Note: Option 001, 002, or 003 must be specified when ordering model 7470A; Option 001 or 002 must be specified with model 7475A.

Interface Cables

- 17255A Male-female, special RS-232-C cable for use with Option 001, IBM Personal Computers
- 17355A Male-male standard cable for use with Option 001
- 17455A Eavesdrop cable for use with Option 001
- 10833A HP-IB 1-metre cable for use with Option 002
- 82167A HP-IL ½-metre cable (included with Option 003)

Plotters

- 7470A Two-pen Graphics Plotter
- 7475A Six-pen Graphics Plotter

630



COMPUTERS, PERIPHERALS & CALCULATORS

Eight-Pen Flatbed Plotters

Models 7220T, 7221T, 9872T

- Drafting pens available
- Choice of interfaces
- Programming language flexibility
- Automatic paper advance

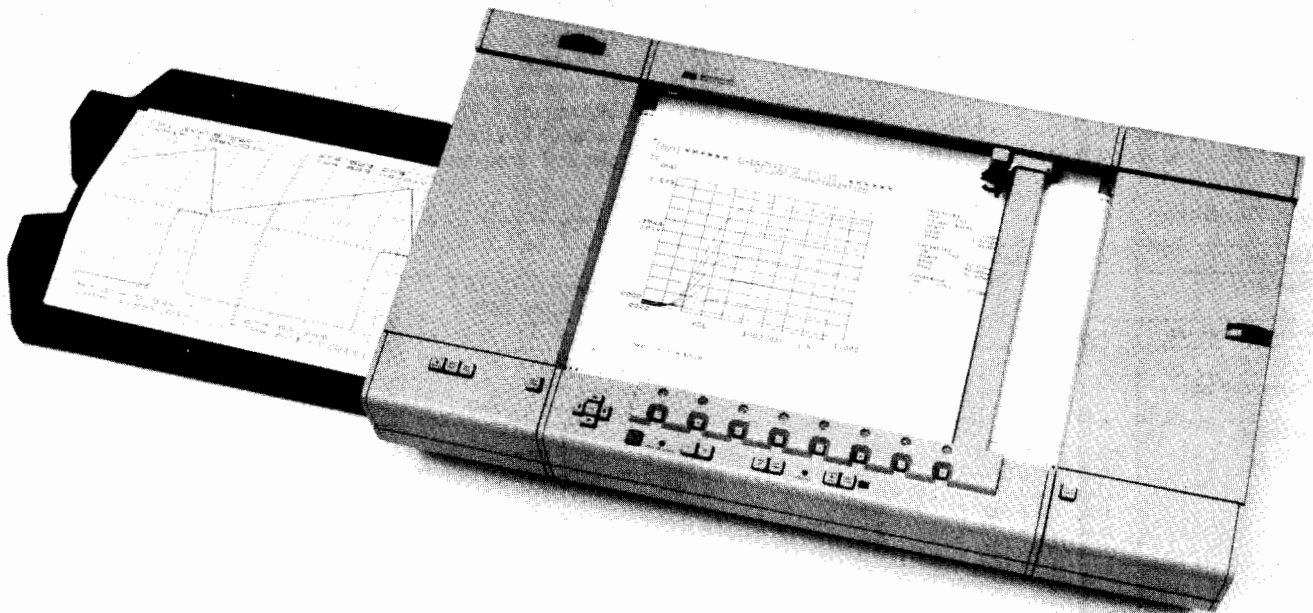

Hewlett-Packard's innovative microprocessor-controlled eight-pen plotters create professional hardcopy graphics for business and industry. They are ideal for plotting applications such as chemical analysis, measurement and test data recordings, manufacturing and engineering drawings, numerical control verification, business and financial planning, education, cartography, and computer-aided design.

Automatic Pen Control

The plotters' automatic pen changing capability makes it possible to use as many as eight different pens on a single plot without user intervention. The plotters automatically store one pen and select another at the push of a button or upon receipt of a program command.

An air-cushioned pen mechanism gently lowers the pen to the writing surface, increasing the life of the pen tip without sacrificing pen speed. Programmable pen velocity allows users to select speeds which suit a variety of plotting media. Air-tight caps protect the pen tips while they are stored.

Fiber-Tip Pens and Drafting Pens

The wide range of pen types, pen-tip widths, and ink colors make HP's eight-pen plotters almost unlimited in their versatility. Three types of pens are available. In addition to HP's fiber-tip pens for paper and overhead transparency film, liquid-ink drafting pens are

available for engineering drawing media (such as vellum and polyester film).

With the fiber-tip pens, users have a choice of ten ink colors for paper and seven colors for overhead transparencies. And fiber-tip pens come in two widths for drawing both fine and bold lines. For flexibility in engineering applications, HP's drafting pen tips are available in six standard line widths. Automatic pen capping increases the convenience of drafting pens by helping to prevent ink from drying in the pen tip.

Versatile Format

The plotters' convenient electrostatic holddown secures any size sheet up to 297 x 420 mm (metric ISO A3) or 11" x 17" (English ANSI B). For application flexibility, programmers can define graph limits and scale the plotting area for different media sizes. Alternatively, users can define graph limits using front panel controls.

Superior Line and Character Quality

Excellent plotter resolution and repeatability contribute to the superior line quality of HP's eight-pen plotters. The smallest addressable move is 0.025 mm (0.001 in.) so lines are straight in all directions, circles are round, and characters are precise. Multiple character sets provide for worldwide use. And for annotation flexibility, the plotters can change the size, slant and direction of the characters.



Powerful Local Intelligence

Each of these versatile plotters provides error-free off-scale data handling, internal character generation, and line pattern and symbol-mode plotting to provide easy trace identification. With the digitizing sight, users can extract coordinates of points on maps or graphs to provide data for detailed computer analysis.

Automatic Paper Advance

The 'T' model plotters will automatically advance and cut paper a half or full page at a time, according to program command or push-button control. (A switch setting governs whether paper will be cut to metric or English dimensions.) This automatic paper advance feature provides cost and time saving advantages of unattended plotting and peripheral sharing.

Choice of Interfaces and Instruction Sets

The eight-pen plotters are available in two interface configurations. Models 7220T and 7221T have an RS-232-C/CCITT V.24 interface with an I/O buffer, choice of modem or hardwire operation, and switch-selectable parity and baud rate settings. The 9872T models have an HP-IB (IEEE 488-1978) interface, permitting simple plug-in connection of several devices with individual control of each.

The plotters speak one of two programming languages. The 7221T models have a compacted binary instruction set which is advantageous in a data communications environment where transmission efficiency is critical. The 7220T and 9872T models feature the Hewlett-Packard Graphics Language (HP-GL) which is a set of easy-to-remember mnemonic instructions. Both languages provide graphics commands that cover the full range of plotting needs, from basic vector plotting to enhanced graphics presentations.

Model	Interface	Internal Instruction Set
7220T	RS-232-C/CCITT V.24	HP-GL
7221T	RS-232-C/CCITT V.24	Compacted Binary
9872T	HP-IB (IEEE 488-1978)	HP-GL

High-Level Graphics Software

HP offers a wide range of graphics software for the eight-pen plotters. High-level graphics language software is available on many HP computers, intelligent terminals, and desktop and personal computers. In addition, HP offers user-interactive graph-generation software for non-programmers. Complete details on these software packages are available from any HP sales and support office.

HP's Industry Standard Plotting Package (HP-ISPP) is a useful tool for FORTRAN programmers. It contains a set of 13 graphics subroutines which permit users to support HP plotters on existing software with only minor modifications.

Specifications

Plotting sizes: accommodates media up to ISO A3 (297 x 420 mm) and ANSI B (11" x 17")

Mechanical limits: Y-axis, 285 mm (11.2 in.); X-axis, 400 mm (15.8 in.)

Addressable resolution (step size): 0.025 mm (0.001 in.)

Repeatability: for a given pen, 0.10 mm (0.004 in.); pen-to-pen, 0.20 mm (0.008 in.)

Plotting accuracy: $\pm 0.2\%$ of deflection ± 0.2 mm (0.008 in.), including linearity and repeatability (assumes plotter has been zeroed to exact lower left (0,0) coordinates)

Pen velocity: pen down, maximum, 36 cm/s (14 in./s) in each axis or 50.9 cm (20 in./s) on 45° angle; programmable from 1 to 36 cm/s (0.4 to 14 in./s) in increments of 1 cm/s (0.4 in./s)

Power requirements: source, 100, 120, 220, 240 V -10% , $+5\%$ (factory set); frequency, 48 to 66 Hz single phase; consumption, 100 W maximum

Interfaces: 9872T: HP-IB (IEEE 488-1978), implements the following functions as defined in IEEE 488-1978: SH1, AH1, T2, L2, SR1, RLO, PP2, DC1, DT0; 7220T and 7221T: RS-232-C/CCITT V.24 asynchronous serial ASCII with switch-selectable baud rate from 75 to 2400 baud

Buffer size: 7220T, 928 bytes (additional 2048 bytes optional); 7221T, 1110 bytes (additional 1928 bytes optional)

Environmental range: 0° to 55°C; 5% to 95% RH (below 40°C)

Size/Weight:

Height	210 mm (8.3 in.)
Width	858 mm (33.7 in.)
Depth	477 mm (18.7 in.)
Net weight	30 kg (66 lb)
Shipping weight	50 kg (110 lb)

Pens: eight; fiber tip and liquid ink drafting pens

Media: paper, overhead transparency film, vellum, and polyester film

Accessories Supplied

Item	Part No.
Digitizing Sight	09872-60066
Operating and Programming Manual	
7220T	07220-90003
7221T	07221-90024
9872T	09872-90011
Pocket Guide	
7220T	07220-90005
9872T	09872-90013
Dust Cover	9222-0741
Male to Male Interface Cable	
7220T	8120-3258
7221T	8120-3258
Paper Tray Assembly	17072-60251

A complete assortment of fiber-tip pens and paper are also provided with the plotters. Drafting media, drafting pens, and other plotter supplies are available from Hewlett-Packard. Please refer to the HP Computer Users Catalog for a complete listing.

Options for 7220T

001 2048-byte additional buffer memory

Options for 7221T

001 1928-byte additional buffer memory

Options for 9872T

025 For use with HP 9825

026 For use with HP 9826

036 For use with HP 9836

045 For use with HP 9835 and HP 9845B

085 For use with HP Series 80 Personal Computers

100 For use with HP 1000

125 For use with HP 125

145 For use with HP 9845C

300 For use with HP 3000

Ordering Information

7220T, 7221T, or 9872T Eight-pen Vector Plotters

COMPUTERS, PERIPHERALS & CALCULATORS

Eight-Pen Drafting Plotters

Models 7580B, 7585B

- 7580B accepts media sizes up to ISO A1 (ANSI D)
- 7585B accepts media sizes up to ISO A0 (ANSI E)
- HP-IB and RS-232-C/CCITT V.24 (switch selectable)
- Choice of pen/media combinations
- Compact
- Moveable

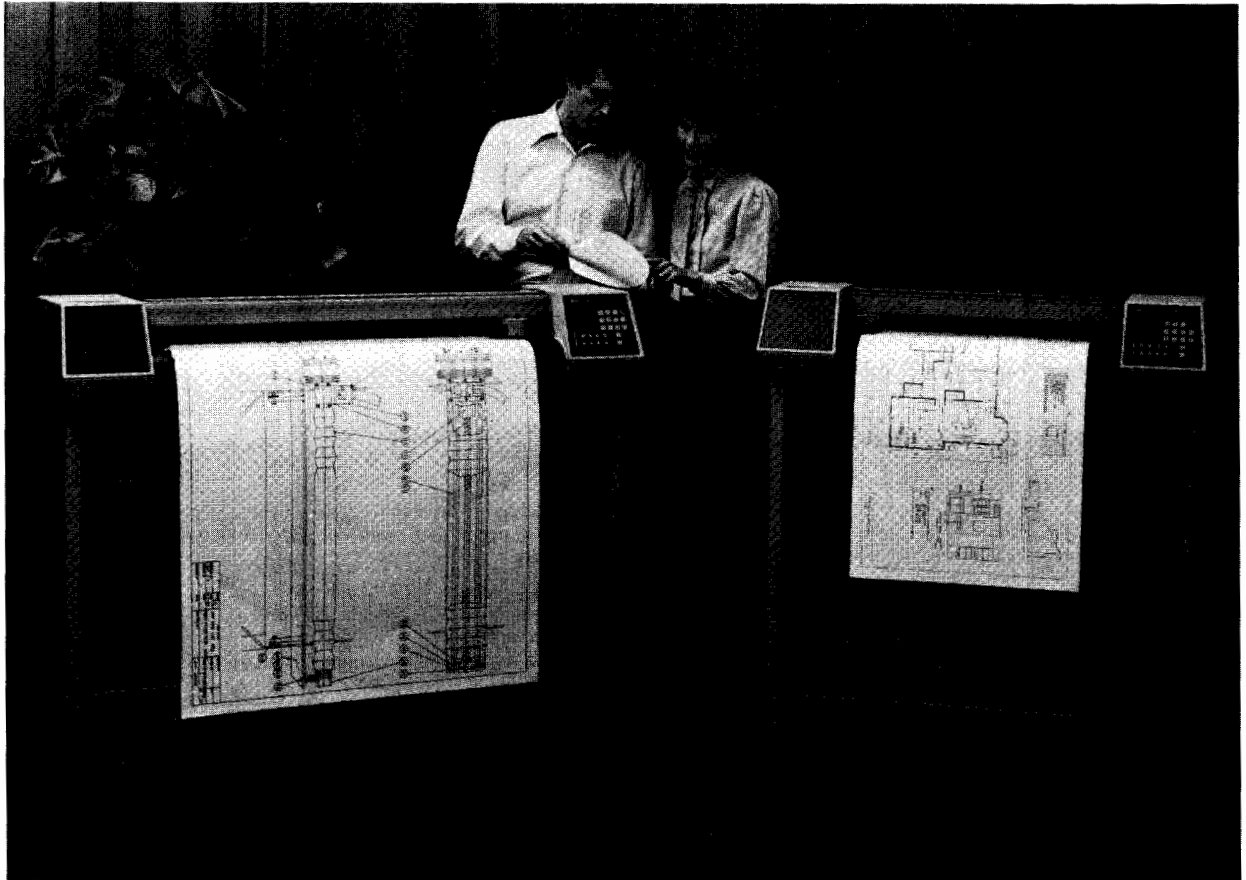

The HP 7580 and the HP 7585 drafting plotters combine high-quality output and high throughput with features that make them exceptionally easy to use. The one important difference between these plotters is media size. The 7580B accepts media sizes ranging from ISO A4 through A1 (ANSI A through D). The 7585B accepts media sizes ranging from ISO A4 through A0 (ANSI A through E).

Both drafting plotters draw on individual sheets of paper, vellum, and double-matte polyester film. Users have a choice of roller-ball, fiber-tip, and liquid ink drafting pens in various colors and line widths. Up to eight pens can be used without operator intervention. Pens are capped when not in use so they last longer and write without repriming.

Applications

The HP drafting plotters are suited for almost any application requiring large plots that are visually perfect. Common uses in industry include computer-aided drafting; computer-aided design of printed circuit boards, integrated circuits, and mechanical parts; architectural or civil engineering design; and mapping applications. In business and management, these plotters are commonly used to prepare flip-charts or project schedules.

Media Drive Mechanism

HP drafting plotters are surprisingly compact because of Hewlett-Packard's micro-grip drive technology. The drive system uses a low

mass, low inertia mechanism to grip and move the drawing medium. This permits the use of smaller motors and lightweight components.

Advanced Writing System

HP's drafting plotters automatically sense sheet size and set the limits of pen motion. Even the pen height is automatically controlled, eliminating the manual adjustments required by many other plotters. Precision control over the settings for velocity, acceleration, and pen force assures high-quality output on various ink and media combinations.

High Quality Output

Resolution is the most important factor that affects line quality. While the addressable resolution of the HP drafting plotters is excellent at 0.025 mm (0.001 in.), the pen and the drawing medium actually move on an even finer grid to create high-quality lines. These movements are controlled by servos with a mechanical resolution of 0.003 mm (0.00012 in.).

In addition to outstanding resolution, HP drafting plotters offer a feature not found in any other drafting plotter: diagonal lines are the same quality as lines drawn parallel to the axes. A microprocessor keeps pen velocity and acceleration constant regardless of direction so lines are drawn with the same high quality in all directions.



High Throughput

At 60 cm/s maximum velocity and 4 g acceleration, the 7580B and 7585B are the fastest plotters in their price range. Even when a slower pen speed is required to accommodate a drawing medium, throughput remains high because pen-up movements are always executed at maximum speed. And pen-lift delays are kept to a minimum because the pen is lifted just slightly on small moves (as when labeling) and to maximum height only on long moves.

Pen Carousels

There are three different pen carousels—one for each type of pen. Each carousel holds up to eight pens and is coded so that the plotter electronically senses the carousel type each time a carousel is loaded. After determining the type, the plotter sets appropriate values for velocity, acceleration, and pen force. Since all of this is automatic, it is remarkably easy for an operator to set up the plotter.

If an application requires it, an operator can select force, acceleration, and velocity using either front panel controls or programmed plotter instructions.

Intelligent Pen Control System

On descent, pen motion is damped as the pen approaches the surface of the medium so that delicate pen tips are not damaged and pen bounce is minimized. Pens last longer and plotted lines are uniform from start to finish. Pen height above the surface is electronically controlled so the operator never needs to make mechanical adjustment, even when changing pens or media.

Quality Labeling

Six different character sets in two fonts provide the user with a large range of annotation capabilities including mapping symbols, special centered symbols, and foreign-language characters.

Simple, Powerful Command Set

Programming is easy using the Hewlett-Packard Graphics Language (HP-GL). The 60 commands implemented on the plotters allow the user to draw lines, circles, or arcs, to position labels, change character size, slant, and direction, digitize, and more. These plotters are even smart enough to adjust dashed line patterns to fit between any two points. They can rescale the plotting area in convenient user-defined units, rotate the plot 90 degrees, or "window" and plot only a portion of the original plot.

Software Support

HP drafting plotters are supported on a number of Hewlett-Packard computer systems, desktop computers, and intelligent terminals. This support, consisting of high-level graphics programming instructions, enhances programmer productivity and ease of use. Several graphics application software packages support the drafting plotters on HP computers.

For users of industry-standard FORTRAN subroutines, a software package, HP-ISPP (Hewlett-Packard Industry Standard Plotting Package), is available.

Specifications

Media sizes: 7580B: minimum, 203 x 267 mm (8" x 10.5"); maximum 622 x 1231.9 mm (24.5" x 48.5"); includes standard sizes A4/A, A3/B, A2/C, and A1/D.

7585B: minimum, 203 x 267 mm (8" x 10.5"); maximum, 927 x 1231.9 mm (36.5" x 48.5"); includes standard sizes A4/A, A3/B, A2/C, A1/D, and A0/E, excludes some nonstandard sizes between A3/B and A2/C.

Maximum plotting area: drawing medium less margins.

Margin size: expanded mode, three margins of approximately 5 mm, fourth margin is approximately 29 mm; normal mode, three margins of approximately 15 mm, fourth margin is approximately 39 mm.

Resolution: smallest addressable move, 0.025 mm (0.001 in.); mechanical resolution, 0.003 mm (0.00012 in.)

Repeatability (for a given pen): On paper or vellum at 10-30°C: 0.05 mm (0.002 in.); on double-matte polyester film (3 mil) at 10-30°C: 0.10 mm (0.004 in.)

Endpoint Accuracy: On double-matte polyester film (3 mil) at 18-30°C, level floor: 0.1% of the move or 0.25 mm (0.0098 in.), whichever is greater.

Pen velocity: pen down, maximum: 60 cm/s (24 in./s) independent of vector direction; programmable: 1 to 60 cm/s in 1-cm increments (0.4 to 24 in./s); front panel selectable: 10 to 60 cm/s in 10-cm increments (4 to 24 in./s); front panel selectable: 10 to 60 cm/s in 10-cm increments (4 to 24 in./s). Pen up, 60 cm/s (24 in./s) independent of vector direction.

Acceleration: maximum, 4 g (39 m/sec², 129 ft/sec²); programmable, 1 to 4 g in 1-g increments (9.7 to 39 m/sec², 32 to 128 ft/sec²).

Pen force: programmable and front panel selectable: 10 to 66 grams in 8-gram increments.

Power requirements: source, 100, 120, 220, 240 V ~ -10%, +5%; frequency, 48-66 Hz single phase; consumption, 182 W max.

Interfaces (selectable from a rear-panel switch): HP-IB (IEEE 488-1978), implements the following HP-IB functions as defined in IEEE 488-1978: SH1, AH1, T6, L3, SR1, RLO, DC1, DT0, C0, PP0 for listen-only, PPI for address greater than 7, and PP2 for address of 7 or less.

RS-232-C/CCITT V.24, asynchronous serial ASCII with switch selectable baud rates of 50, 75, 110, 134.5, 150, 200, 300, 600, 1200, 1800, 2400, 3600, 4800, 7200 and 9600.

Buffer size: 1024 bytes.

Environmental range: operating, temperature 0°C to 55°C, relative humidity 5% to 95% (0°C to 40°C); non-operating, temperature -40°C to 75°C, relative humidity 5% to 95% (0°C to 40°C).

Size/Weight	7580B	7585B
Height:	1188 mm (46.8 in.)	1188 mm (46.8 in.)
Width:	1087 mm (42.8 in.)	1392 mm (54.8 in.)
Depth:	557 mm (21.9 in.)	557 mm (21.9 in.)
Net weight:	59.1 kg (130 lb)	70.4 kg (155 lb)
Shipping weight:	approx 114 kg (250 lb)	approx 131 kg (290 lb)

Pens: 8 per carousel; fiber tip, drafting, roller ball.

Media: most standard paper, vellum, and double-matte polyester film, 3 or 4 mil thick.

Accessories Supplied

Interfacing and Programming Manual

Operator's Manual

Programmer's Reference Card

3 Pen Carousels

drafting pen carousel

roller ball carousel

fiber tip carousel

Digitizing Sight

Male-to-male RS-232-C/CCITT V.24 cable

An assortment of pens and various drawing media and cleaning supplies are also provided with the plotter.

Drafting media and other plotter supplies are available from Hewlett-Packard. Please refer to the HP Computer Users Catalog for a complete listing. Media and liquid ink drafting pen tips may be purchased from your local engineering supply store. Refer to the Operator's Manual for information on suitable pen tips and media.

Options

016 for use with HP 9816 desktop computer

025 for use with HP 9825 desktop computer

026 for use with HP 9826 desktop computer

036 for use with HP 9836 desktop computer

045 for use with HP 9835A/B or HP 9845A/B desktop computer

047 for use with HP 2647 graphics terminal

085 for use with HP-85 personal computer

100 for use with HP 1000 computer

145 for use with HP 9845C desktop computer

300 for use with HP 3000 computer

900 for use with HP 9000 computer

Ordering Information

7580B Drafting Plotter

7585B Drafting Plotter

OEM discounts available

HP Part No.

07580-90024

07580-90023

07580-90021

07580-60081

07580-60082

07580-60035

07585-60191

8120-3258

COMPUTERS, PERIPHERALS & CALCULATORS

Graphics Tablets

Models 9111A and 17623A

- Sixteen user-definable softkeys on the 9111A
- Durable ceramic surface

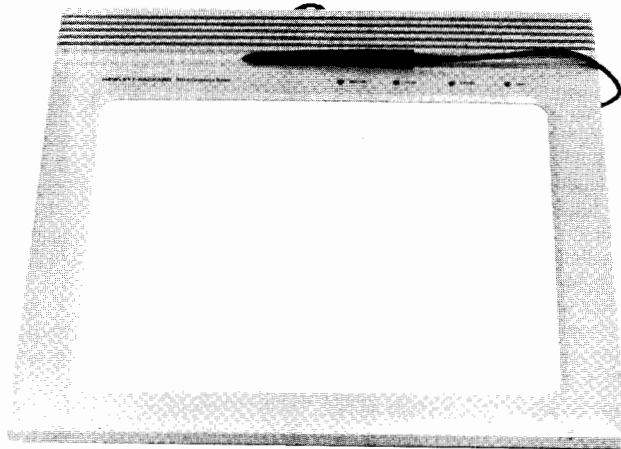

Hewlett-Packard's 9111A graphics tablet adds a new dimension to interactive graphics systems equipped with the HP-IB (IEEE-488) interface. With the tablet's cursor moving capability, the user can bypass the keyboard and interact directly with the CRT display. He can use single-point or continuous digitizing modes to create designs, to enter graphic data from source documents, or select information from a customized menu.

Programmable Capability

Twenty-seven HP-GL commands provide the user with precise control of all tablet functions. Two features of the 9111A which affect the rate of data transfer are programmable. The tablet update rate can range from a minimum of 1 to a maximum of 60 points per second. The maximum rate matches the refresh rate of most display screens, permitting smooth cursor movement. When the tablet is programmed for binary data transfer, system performance rates are improved by eliminating the overhead of ASCII conversion in the mainframe.

Sixteen softkeys can be programmed by the user. In addition, any portion of the active digitizing area can be defined as soft keys for increased menu selection capability.

Additional Features

The tablet is made of high quality durable materials which make it another superior Hewlett-Packard product. The platen's hard ceramic surface resists scratches and pits; the stylus is slim and lightweight with good tactile feedback on the switch position. Interchangeable inked and non-inked refills are available for the stylus. For audio feedback, the 9111A has a four-octave beeper which is programmable in tone, volume, and duration.

Software Tools

Graphics tablet system tools are available for use with the HP-85 and HP 9845B/C computers. See page 635 for descriptions and ordering information. Basic language extensions and manual supplements are available as options for users of HP 9826A/36A computers.

135X/9111 Graphics Display System

Together with the HP 1350S or 1351S graphics display systems, the 9111A provides direct tablet-to-display interaction for cursor movement and rubber banding of lines and rectangles. This configuration offers quick response time and minimized computer overhead. It is also supported on GRAPHICS/1000-II software.

- Direct tablet-to-display interaction
- Electrostatic platen technology

Specifications

Resolution: 0.100 mm (0.00394 in.)

Accuracy: ± 0.600 mm (0.0236 in.) at 20 °C for each measured point, change of 0.004 mm for each °C deviation from 20 °C

Repeatability: \pm resolution unit

Data rate: programmable from 1 to 60 coordinate pairs per second, actual rate ± 2 Hz from programmed rate

Active digitizing area: 218.5 x 300.8 mm (8.6" x 11.8"); can be extended to include the area occupied by the 16 softkeys

Document material: single sheet, electrically nonconductive, homogeneous, less than 0.5 mm thick

Interface: HP-IB (IEEE 488-1978). Implements the following HP-IB functions as defined in IEEE 488-1978: SH1, AH1, T5, TE0, L4, LE0, SR1, RL0, PP2, DC1, DT0, C0

Power requirements: source: 100 V, 120 V, 220 V, 240 V, $\pm 10\%$; frequency: 48 to 66 Hz; consumption: 100 V/200 mA max, 120 V/165 mA max, 220 V/90 mA max, 240 V/80 mA max, 25 W max

Environmental range: 0° to 55 °C, 5% to 90% RH (40 °C)

Dimensions: 440 L x 440 W x 85 mm H (17.3" x 17.3" x 3.4")

Weight: net 5.8 kg (12.8 lb). Shipping 10.8 kg (23.8 lb)

Ordering Information

Option	HP Computer	Description
026	HP 9862A	Supplements to BASIC Language Reference and BASIC Programming Techniques manuals; BASIC extensions
036	HP 9836A	Same as above
045	HP 9845B	System tutorial
085	HP-85	System tutorial and tools software
086	HP-86/87	9111A Graphics Tablet Programming Guide
100	HP 1000	For purposes of documentation
145	HP 9845C	Sample program

9111A Graphics Tablet

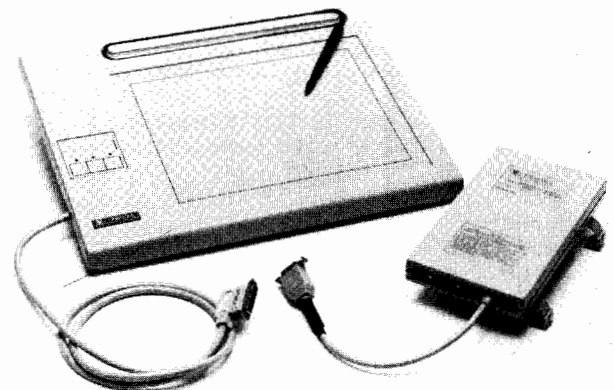

The HP 17623A graphics tablet is designed specifically for use with the HP 2623A monochromatic and HP 2627A color graphics terminals in an RS-232-C environment. It is connected directly to the terminal power supply for local cursor control. This direct tablet-to-display interaction minimizes host computer overhead making the tablet ideal for timeshare situations which require menu selection, digitizing, and cursor movement without time delay.



High Resolution

You can digitize to the host computer at a resolution four times greater than that of the terminal's screen when you need high-quality hardcopy output. Or if the speed of data transfer is most important, you can use the screen's resolution.

Flexible Digitizing

Several features make digitizing more flexible and adaptable to various applications. Coordinate data can be sent to the computer in ASCII format for easier programming or binary format to reduce data transfer time; synchronous and asynchronous transfer modes allow you to digitize one coordinate or send a stream of data each time the stylus is pressed.

Additional Features

The tablet is reversible for left-handed use. Just push a button on the front panel to rotate the tablet's coordinate system and use the tablet upside down. The folding support and front-panel button labels are also reversible.

Graphics Software

You can develop your own software or use one of the packages available. The tablet is supported on the HP 1000 by GRAPHICS/1000-II DGL (92841A) or GRAPHICS/1000-II AGP (92842A); on the HP 3000 by HPDRAW (33108A) or the HP3000 Business Graphics Package, which includes HPDRAW (32110A); and on the HP 9000 series by GRAPHICS/9000 DGL (92074A or 92084A) or GRAPHICS/9000 AGP (92075A or 92085A).

Specifications

Active digitizing area: 295 x 225 mm (11.6 x 8.8 in.)

Resolution: (points within active digitizing area): fine—2048 x 1560, coarse—512 x 390 (matches CRT)

Repeatability: ± 1 resolution unit

Cursor tracking rate (local): 30 pts/s

Coordinate transfer rate: assumes asynchronous data transfer; depends on computer activity and data communication rate, e.g.,

ASCII @ 2400 BAUD-up to 15 pts/s

@ 9600 BAUD-up to 60 pts/s

Binary @ 2400 BAUD-up to 34 pts/s

@ 9600 BAUD-up to 60 pts/s

Heavy system activity can severely degrade these rates.

Platen technology: electrostatic

Document material: single sheet, electrically nonconductive, homogenous, less than 0.5 mm thick

Environmental range: 0° to 55 °C, 5% to 80% RH (40 °C), EMI meets VDE requirements with the HP 2627A and HP 2623A terminals on HP 1000, HP 3000, and HP 9000 series computers

Power consumption: 5 W max (supplied from the terminal)

Dimensions: 467 L x 367 W x 38 mm H (18.4 in. x 14.4 in. x 1.5 in.)

Weight (tablet and interface module): net 3.62 kg (8.0 lbs). Shipping 6.8 kg (15.0 lbs)

Accessories Supplied

Operator's Manual

Stylus Refills (2 Inkless, 3 Ink)

Overlay (1)

HP Part No.

17623-90001

09111-68701

4114-0962

Ordering Information

17623A Graphics Tablet

Graphics Software

Software for HP Plotters: HP-ISPP

This software package minimizes the effort required to develop data plots on any of HP's plotters with RS-232-C/CCITT V.24 or HP-IB interfaces. It is written entirely in ANSI Standard FORTRAN (X3.9-1966); input and output to the plotter is accomplished through standard FORTRAN formatted read/write statements. The package is supplied in source language form on either magnetic tape or flexible diskette format depending on the option specified.

HP-ISPP can be easily installed on almost any ASCII-based computer system that offers the equivalent of 32,000 sixteen-bit words or more for user application program space. The system must provide a standard asynchronous terminal driver (or equivalent I/O communications software) capable of communicating with the plotter through FORTRAN read/write statements within a user-written application program.

The package contains 13 graphics subroutines which support the following HP-GL plotters: 7220C/T, 7240A, 7245B, 7470A, 7475A, 7580A/B, 7585A/B, and 7225B with 17601A, 17603A, or 17604A personality modules. These subroutines can be used for small systems or as tools for adapting existing higher-level software for use on HP plotters.

HP-ISPP Features

- Provides absolute coordinate pen positioning from the origin (in centimetres or inches) and multiple pen selection
- Scales plots larger or smaller and changes plot origin
- Draws symbol strings at various angles and sizes
- Plots floating point numbers in FORTRAN 'F' format
- Draws and annotates axes
- Scales data to fit on a graph of a given size
- Connects a set of data points with straight lines
- Generates special characters at data points

9111A Graphics Tablet Software

The 9111A graphics tablet system tools provide software to link the 9111 with the HP 9845B/C desktop computers and the HP-85 personal computer. The 9845B/C software makes it easy to create simple graphics, assemble complex diagrams, or design menus. Tools for the 9845C also allow users to select colors on the graphics display screen.

Software for the HP-85 (9111 option 085) includes sample programs to help users create, edit, store, and plot drawings; create data files of digitized points; and calculate scaled distances or areas inside traced figures.

Ordering Information

17580A HP-ISPP Software (specify media option from Table 1)

88100A System Tools for HP 9845B, Option 1XX

88101A System Tools for HP 9845C, Options 1XX and 2XX

Table 1

No.	Media Options for HP-ISPP
001	800 BPI magnetic tape, 9-track, unlabeled, unblocked, 72 byte fixed-length records, ASCII character code
002	1600 BPI magnetic tape, 9-track, unlabeled, unblocked, 72 byte fixed-length records, ASCII character code
003	Flexible diskette, single-sided, single-density, compatible with Digital Equipment Corporation RX01 dual drive used under RT-11 operating system

COMPUTERS, PERIPHERALS & CALCULATORS

Supplies and Accessories for Graphics Plotters

- Pens, drawing media, accessories
- Optimize plotter performance
- Wide selection
- Convenient ordering

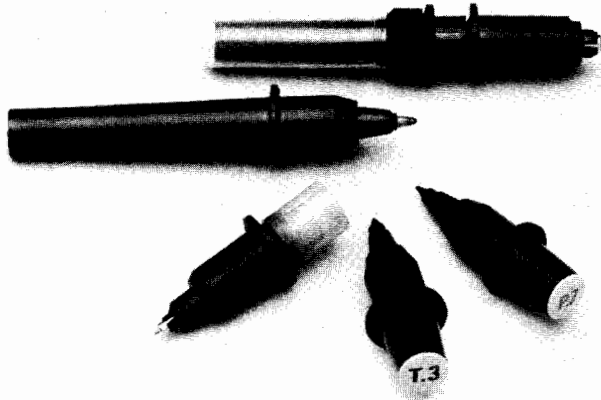

Hewlett-Packard high quality supplies bring out the best in HP's graphics plotters. For your convenience, HP offers a complete line of pens, drawing media, and accessories such as pen holders, digitizing sights, ink solvent, drafting pen tips, and cleaning aids. You can order supplies individually or in convenient kits. Either way, HP can supply everything you need for professional-looking, hardcopy graphics.

Plotter Pens

HP pens extend the capability of HP plotters because of the variety of pens available. Users can choose from three pen types (fiber-tip, roller-ball, and drafting pens) in a wide range of tip widths and ink colors.

In graphics plotting, the pen is the most critical link between a high-performance machine and high-quality plotted results. For this reason, HP designs and manufactures pens to stringent specifications. Concentricity of the pen body and the distance between indexing flange and tip are monitored carefully during production; this ensures accurate tip placement and line repeatability during plotting. In addition, HP's inks are specially formulated for easy-starting flow. They dry almost instantly when applied to HP drawing media. The colors are vivid, producing publication-quality graphs and charts, and professional-looking overhead transparencies.

Pen Holder and Organizer

HP's sturdy 4-pen holder and our new 20-pen organizer offer the perfect solution to protect your pens from loss or damage. The pen holder (07225-40054) can be placed next to your plotter for easy access to a selection of fiber-tip, roller-ball, or short-body drafting pens. The pen organizer (5061-5100), a compact and portable case made of smoked plastic, is designed to keep pens neatly in place even if turned upside down. It stores up to 20 fiber-tip or short-body liquid ink pens and up to five drafting points. A recessed space is provided for extra pen caps and drafting point keys.

Drawing Media

HP's drawing media complement the performance of HP plotters. Plotter paper, tracing bond, vellum, polyester film, and overhead transparency film are available from Hewlett-Packard in a range of standard sizes.

Users can select blank or printed sheets of plotter paper in metric or English sizes and grids. And roll paper is available for plotters with automatic paper advance capability. For engineering applications, HP provides tracing bond, vellum, and double-matte polyester film of the finest quality. Clear film for overhead transparencies is available by the package or in convenient kits.

Overhead Transparency Kits

With an HP overhead transparency kit and an HP plotter, users can make professional-looking presentation aids for only a fraction of the amount charged by commercial graphics services. The same programs used to prepare plots on paper can be used to make overhead transparencies. Finished transparencies are colorful and virtually smearproof, so they can be used again and again.

Several overhead transparency kits are now available. Each kit is designed to accommodate one of the two types of plotter technologies offered on HP plotters. For example, on the flatbed plotters the drawing sheet remains stationary during plotting while on the 7470A and 7475A the sheet is moved back and forth during plotting. In addition, kits for the 7475A come in either English or metric sizes.

Each kit contains transparent sheets of plastic film and 16 fiber-tip pens in 2 tip widths (approximately 0.3 mm and 0.6 mm). Pen colors are black, red, green, blue, violet, orange, and brown. With our new improved transparency film, the ink adheres evenly to the film surface, dries in seconds at normal room temperature, and maintains its vivid color when projected. The kit contents are packaged in a convenient storage box along with complete instructions.

Paper and Pen Kit

A new paper and pen kit is available for use with all HP plotters. This convenient kit contains all the supplies you need to create effective graphs on paper. It comes in both English A-size (8.5 x 11 in.) and metric A4-size (210 x 297 mm) and includes 20 fiber-tip pens in two line widths (0.3 mm and 0.7 mm) and 10 vivid colors. Also included is a sturdy pen-holder which holds up to four pens. These supplies are packaged in a handy storage box along with complete instructions for paper and pen usage.

More Information on Supplies and Accessories

It's easy to order plotter supplies and accessories from HP sales and support offices or through HP's direct telephone ordering service. The HP Computer Users Catalog (5953-2450), which is available from any HP sales and support office, describes the complete range of supplies and accessories.

Part Number	Plotter	Contents	
5061-7560	7220, 7221, 9872 & 7225 if equipped with velocity-select capability	200 sheets of transparency film, each 216 x 279 mm (8.5 x 11 in.); ink solvent; 16 pens	
5061-7561	7470	50 sheets of paper-backed transparency film, each 216 x 279 mm (8.5 x 11 in.); 16 pens	
5061-7580	7475: English	50 sheets of paper-backed transparency film, each A-size (8.5 x 11 in.); 16 pens	
5061-7581	7475: Metric	50 sheets of paper-backed transparency film, each A4-size (210 x 297 mm); 16 pens	
5061-5070	All HP plotters: English	300 sheets A-size (8.5 x 11 in.) paper; 20 pens; pen-holder	
5061-5071	All HP plotters: Metric	300 sheets A4-size (210 x 297 mm) paper; 20 pens; pen-holder	



Introduction to Softcopy Graphics

The need to display and update graphical data in real-time is of primary importance in a number of computer-driven applications. It is also necessary in many applications to display the data quickly and with high resolution. To meet these needs, Hewlett-Packard offers a number of CRT displays and display systems for engineering and scientific disciplines. Depending on the particular HP display or display system chosen, available features are programmable intensity levels, programmable line types, large screens, character generation, and choice of interface.

What is Softcopy Graphics?

Softcopy graphics uses some volatile device to display the graphical information, in most cases a CRT display. Unless the picture is stored by some means, it is lost when the system is turned off. Because information is not stored by the device, softcopy graphical displays are particularly suited to interactive computer graphics systems.

Softcopy or Hardcopy?

Both hard and softcopy graphics have appropriate applications. While plotters and other hardcopy devices provide a permanent record of the picture, they cannot react in real-time. Since it takes a hardcopy device some length of time to plot, making changes to a picture, while using a plotter as a peripheral in an interactive graphics system, would be a time-consuming task. On the other hand, a CRT display can show changes to the picture in real-time, allowing the operator to alter the graphical data and see the results immediately. Because the display is not a permanent storage device, changes can be made while errors are erased from the screen. When all changes are complete, the finished picture can be "dumped" to a hardcopy peripheral for retention.

Softcopy graphics is also essential in areas where decisions are made on the basis of rapid input of information. Radar display is an example. In such an application, high display resolution as well as high speed data-updating capability are needed to show and update complex pictures quickly.

Electronic instrumentation makes use of softcopy graphics in a number of areas such as oscilloscopes, spectrum analyzers, waveform analyzers, and logic analyzers. Because of the ability of graphics to portray large amounts of data in a form that is easily and quickly assimilated, such instruments use CRT displays.

Choice of Interface

Several HP displays and display systems give the user a choice of three interfaces: HP-IB, RS-232C, and 16-bit parallel. The HP 1351A Graphics Generator can take digital information from one of the three interfaces mentioned above and change it to X, Y, and Z analog voltages necessary to drive HP large screen displays. In addition, the 1345A Digital Display Module can accept commands via 16-bit parallel and is suited for OEM instrumentation graphics.

Applications

- Schematic generation
- Engineering design and evaluation (mechanical, electrical, chemical, etc.)
- Radar/sonar control/monitoring
- Real-time instrumentation systems (data acquisition/analysis, production testing)
- Architectural design
- Interactive computer graphics systems

Advantages

- High resolution
- High drawing and update speed
- Bright, crisp vectors and characters
- Choice of screen sizes
- Digital and analog display interface available

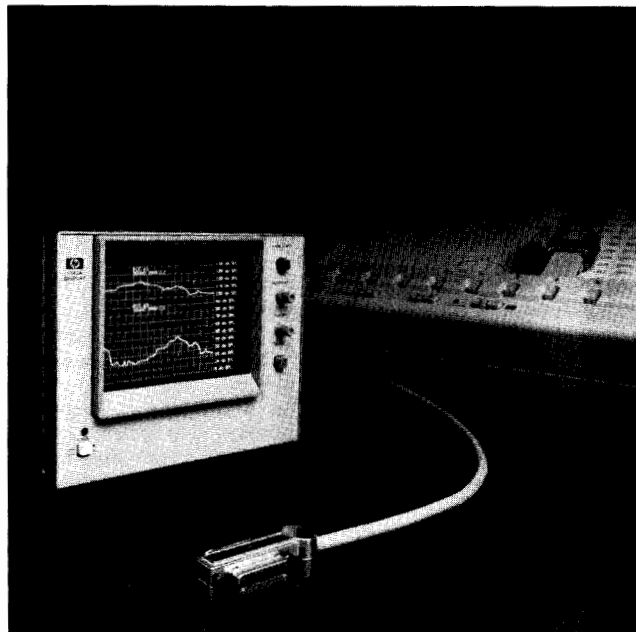

Softcopy Data-Scrolling

The 1347A HP-IB Display provides data-scrolling capability, an extremely powerful form of softcopy graphics. The 1347A can scroll through data stored in memory horizontally across the screen in both directions. It can display as many as 32 waveforms at one time, and it can scroll graticules as well as text and/or waveforms.

Softcopy data-scrolling is extremely useful in applications that require monitoring and analyzing data, and data-scrolling with the 1347A provides the data you need to analyze faster than a paper strip chart recorder can.

The softcopy data displayed on-screen while the 1347A is in its scrolling mode can be duplicated on an HP-IB/HP-G1 plotter, giving you a "snapshot" of the scrolled data. Then, the 1347A resumes scrolling after the plot is finished, losing none of the data in the interim because it stored that data in its memory.

COMPUTERS, PERIPHERALS & CALCULATORS

Instrumentation Graphics Systems

Models 1351S, 1351A

- Computer/calculator compatible digital interface
- Fast display updating
- High resolution graphics
- 8k vector/character generator
- 64 addressable memory files
- Optional screen sizes and phosphors

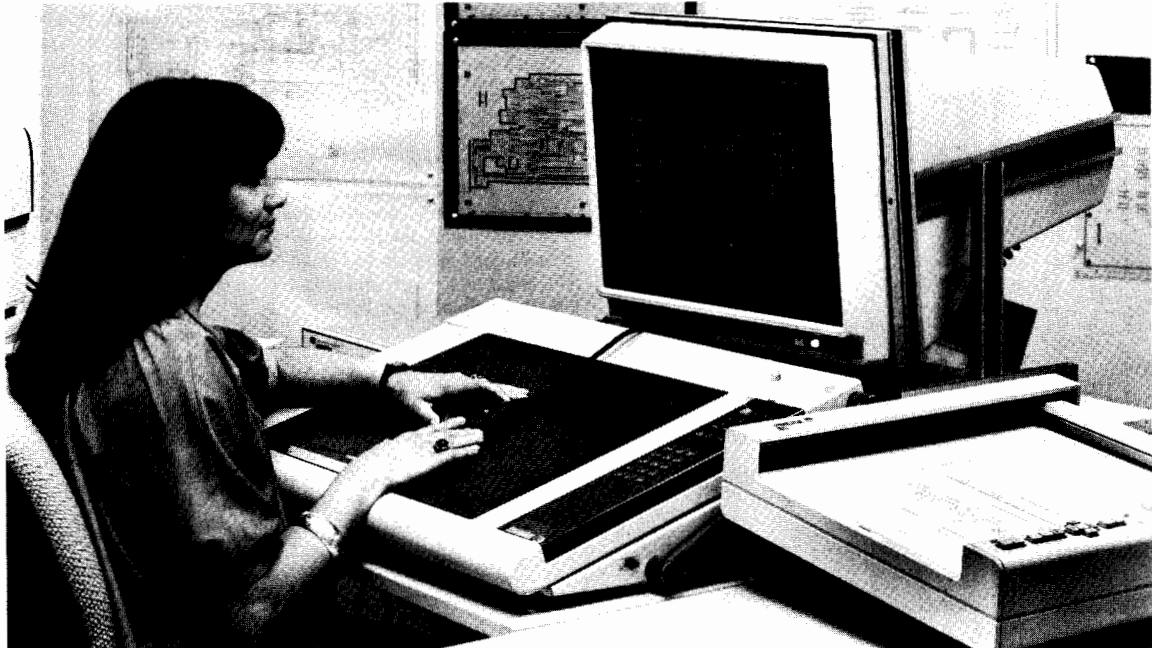

Computer Graphics Display System

The 1351S Graphics System provides a high resolution, real-time method of generating bright line vectors and/or alphanumeric characters. This cost-effective system includes a high quality, large-screen electrostatic CRT display (with programmable binary Z-axis control) and the 1351A Graphics Generator. The system gives bright graphics in minicomputer or desk-top computer systems with a resolution of 1020 x 1020 addressable points on the CRT screen. In addition, it provides the fast information throughput, rapid picture manipulation, and complex vector drawing capability needed in interactive computer graphics for computer-aided design/ computer-aided manufacturing (CAD/CAM) systems, and radar/simulation.

Programmable Features

The 1351A has 64 memory files that are selectable in size, separately addressable and erasable, and can be directed to flash selected information on and off. Variable vector drawing speeds provide three intensity levels for highlighting selected information. This allows the programmer to highlight on-screen menus, cursors and grids, as well as enhance 3-D drawings, add perspective, or otherwise improve visual clarity and meaning. The 1351A can also produce seven intensity levels for data differentiation via a Binary Z Control on the large screen display.

Each digital word in the 1351A can be a vector coordinate or an upper or lower case ASCII character. A character ROM generates each ASCII character while using only one word of RAM in the 1351A memory, making more RAM available for other display information. Each character can be programmed to be displayed in four different sizes with two orientations (horizontal and 90 degree rotation).

CAD/CAM Applications

Modeling: with the 1351S as part of a CAD system, a designer has a highly interactive display system with which to create complex wire-frame models. Through a graphics tablet or keyboard, the designer can immediately see the results of inputs. After the model has been generated, it can be stored in a computer data base for other CAD/CAM uses or for refinement later in the design process.

Analysis: a CAD/CAM system using the 1351S can also be used in stress analysis. Using the finite-element technique, the model is broken down into a network of simple elements that a computer uses

to determine stress, deflections, and other structural characteristics. For example, the 1351S can be used to display a deflected shape superimposed over the original model. With the 1351S's highlighting capability, the designer can rapidly analyze a model because the 1351S provides visual differentiation. In this way, the design can be modified prior to building costly physical models and prototypes.

Kinematics: CAD systems that include kinematic features for animating the motion of mechanisms are ideally suited to the fast drawing and selective erase capabilities of the 1351S. Complex mechanisms can be designed quickly, without the traditional pin-and-cardboard models or lengthy mathematical equations.

Drafting: CAD systems with automated drafting are many times faster than manual drafting. Such a system requires a large, high resolution CRT display for easy viewing. The high speed vector generating capability of the 1351S allows the draftsman to generate several views of a structure or of complex IC or PC drawings rapidly.

RS-232-C or 16-Bit Parallel Optional Interface

The 1351A has a flexible interface structure to allow one of three specific interfaces to be used. Changing from one interface type to another is accomplished by changing the plug-in interface card. An HP-IB interface is standard with optional RS-232-C and 16-bit parallel interfaces available.

Ordering Information*

1351S Display System (includes 1311B display and 1351A)

1351A Graphics Generator

*An HP-IB cable is not supplied and must be ordered separately.

Options and Accessories

001: RS-232-C interface in lieu of standard HP-IB

002: 16-bit parallel interface in lieu of standard HP-IB

510: 1310B, 19 in. X-Y display in lieu of 1311B

517: 1317B, 17 in. X-Y display in lieu of 1311B

521: 1321B, 21 in. X-Y display in lieu of 1311B

604: P-4 phosphor display, no graticule

639: P-39 phosphor display, no graticule

908: Rackmount hardware for 1351A and 1311B

COMPUTERS, PERIPHERALS & CALCULATORS

Large-Screen Computer Graphics Displays

Models 1310B, 1311B, 1317B, 1321B

639



- Fast settling time low power consumption
- Excellent image quality

- Ideal for use as a computer peripheral
- CRT viewing area from 14 inches to 21 inches diagonally

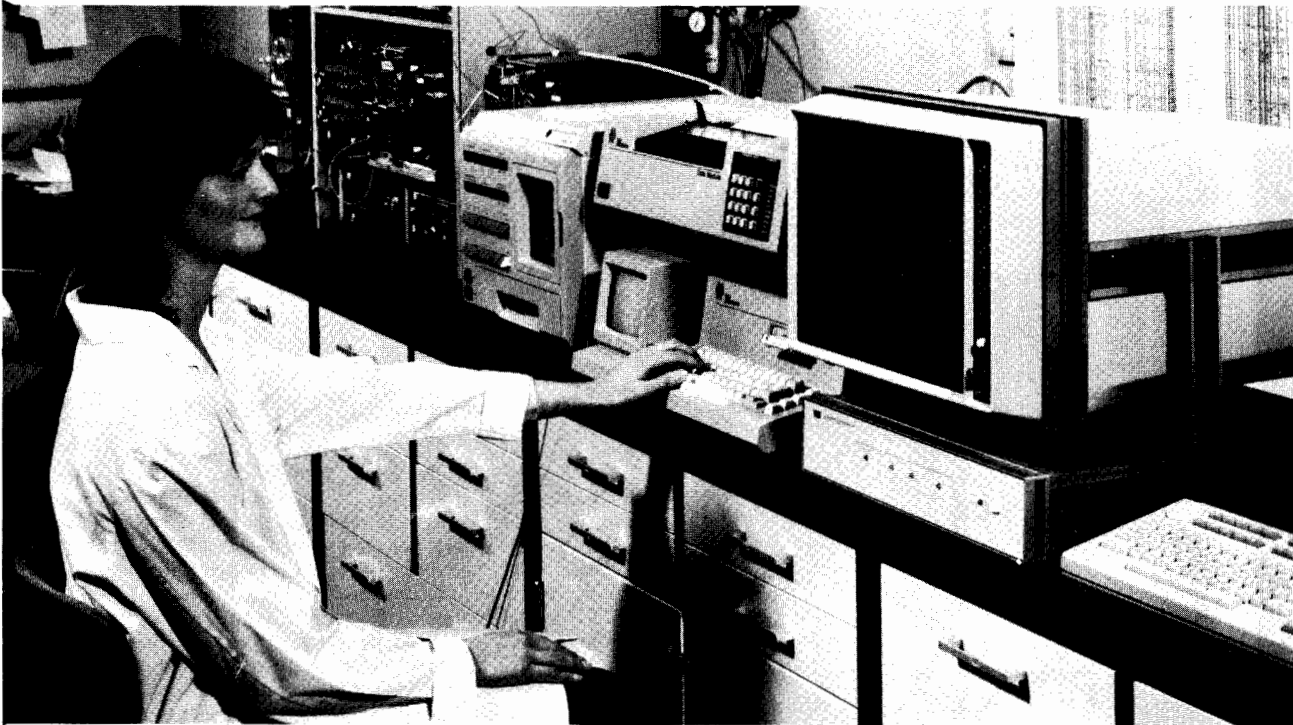

The HP 1311B is used here as the display in a chemical analysis system

Versatile Computer Graphics Displays

Hewlett-Packard's Models 1310B, 1311B, 1317B, and 1321B large screen displays offer the high writing speed, fast settling time, brightness and contrast needed for the display of high density graphics information. These displays are ideal computer peripherals with the high picture quality and dynamic performance required for complex computer generated graphics. Any on-screen movement can be made in less than 500 ns, including settling time. This high speed performance is particularly useful in radar and simulation, where many symbols must be moved about almost simultaneously. It is also useful in computer-aided design (CAD) applications which require complex, high density drawing capability.

These high resolution displays remain exceptionally well focused in all parts of the screen which solves such difficult display problems as writing many characters around the picture edges, while showing great detail in curves, graphs, or diagrams. Excellent image quality is further assured with features such as a contrast control circuit which provides constant contrast with variations in intensity, and a flat, optical quality glass contrast filter which eliminates trace diffusion and minimizes glare.

The 1310B, 1311B, 1317B, and 1321B are electrically almost identical, but offer a wide range of sizes and configurations to fit almost any high-speed, large screen OEM display requirements. The 1321B has the highest overall resolution (screen area divided by spot size) of any HP CRT display, making it the choice for applications where maximum information density is the main consideration. The 1317B is ideal for standard 48.3 cm (19 in.) rack-mount applications requiring the largest possible screen area in the minimum vertical rack space. For table-top applications such as remote monitors, Models 1310B and 1311B offer an attractively styled enclosure with a tilt stand. Both displays may be ordered without the tilt stand (Opt 001) for mounting in standard 48.3 cm (19 in.) racks or custom designed enclosures.

Picture Clarity

Spot resolution of these large-screen displays is a maximum of 0.51 mm (0.020 in.)—1311B: 0.43 mm (0.017 in.)—and remains excep-

tionally well-focused in all parts of the screen. These displays use an aluminized screen and 28.5 kV accelerating potential, allowing brightness great enough to ensure a crisp presentation of complex computer graphics pictures. The 1310B, 1311B, 1317B, and 1321B use a contrast control circuit that offers constant contrast with variable intensity, ensuring excellent image quality. This allows you to increase or decrease image brightness without affecting the contrast between picture elements.

Computer Interfacing

The increasing use of mini- and microcomputers for data bases and data reduction as well as design aids has resulted in a need for high quality displays that easily interface with a computer. A cost-effective solution to a wide spectrum of demanding graphics applications such as CAD/CAM includes the HP 1351A Graphics Generator, which is an ideal interface between a computer and a 1310B, 1311B, 1317B, or a 1321B. The graphics generator can store data in memory and continually refresh the display, reducing the load on your computer.

Safety

Safety protection is designed and built into the 1310B, 1311B, 1317B, and 1321B. In each of these displays, the high voltage anode lead is permanently bonded to the CRT. The CRT complies with UL implosion and impact requirements, and X-ray emission is held below 0.5 mr/hr through the use of Strontium-doped glass.

Ordering Information

For information on options and accessories, refer to the applicable large screen CRT data sheet.

1310B 48 cm (19 in.) Display
1311B 36 cm (14 in.) Display
1317B 43 cm (17 in.) Display
1321B 53 cm (21 in.) Display
OEM discounts available



COMPUTERS, PERIPHERALS & CALCULATORS

Computer Support

Overview/Software Training and Consulting

- Assured lasting value for your HP computer products
- Broad range of services worldwide
- Expert instruction from the company who designed and built your system
- Specialized solutions for planning and integrating systems

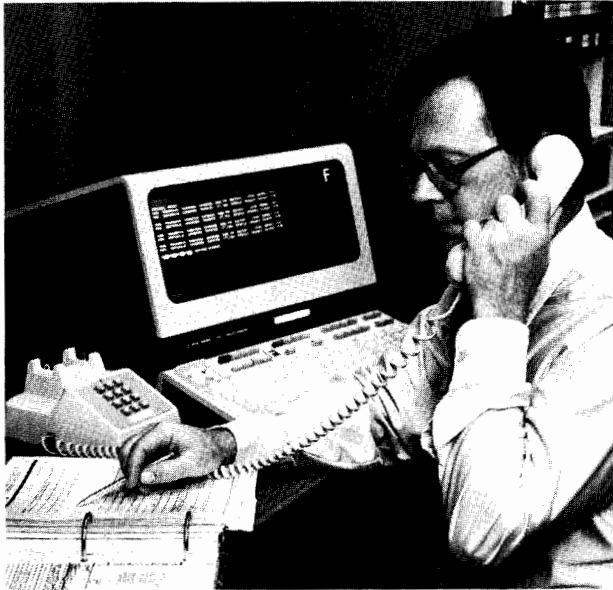

Overview

HP's support services sustain the lasting value of your HP computer system. Throughout its lifetime, your HP computer system will be maintained to meet its performance specifications. More important, our training, consulting, and ongoing user support will help you make your HP products an answer to your application needs. In short, HP support services provide the resources you need to use your products successfully.

Cost effective: you can tailor the most effective support program for the lowest cost using HP's broad range of support services. Compare the performance features of HP's support programs to your cost as a percentage of the equipment's list price. Or calculate your three year cost-of-ownership, including hardware, software, and support costs. You'll find HP ranks well against the competition in both areas.

New service programs: our goal is to introduce innovative support services tailored to your needs. Programs like Guaranteed Uptime Service for the HP 3000 systems and System Information Service for desktop and personal computers are examples of HP's specialized solutions for effective support.

Lasting value: for services to provide lasting value, they must consistently meet or exceed customer expectations. How do our customers rate HP support? In 1983, a major survey asked over 3,500 customers to rate systems and service from 24 minicomputer vendors. HP maintenance services and mainframe reliability both received the highest ratings in the survey.

Consistent support worldwide: specified services ensure that you receive consistent support throughout the world no matter which HP office provides the services. You receive a detailed set of specifications for every service purchased, so you know what to expect from HP's support programs.

Software Training and Consulting

Today's capable software systems require training and expert consulting in order to be used most effectively. HP training courses enable you to better understand the system, its utilization, and capabilities. This instruction can improve your productivity and significantly reduce implementation time.

To aid in planning and installing a complete computer system, HP offers the consulting services of an experienced HP Systems Engineer (SE). The SE can offer suggestions for enhancements, new uses for specific applications, and recommendations for improving efficiency of operation. Skilled, advanced planning means good integration of a product with its application and ensures early end-user satisfaction.

Software Training—Proficiency for Users and Programmers

HP offers training courses to instruct you in the theory and operation of HP software so that you can more fully and effectively utilize your system. This training includes a full complement of standard courses which range from introductory to advanced levels and emphasize both lecture and laboratory.

Regularly scheduled courses are offered at well-equipped training centers in most area sales offices. If you have a large programming staff, you may find optional, on-site courses a cost-effective alternative. In addition, self-paced courses have been developed for the HP 3000 which provide low-cost instructional material on selected topics.

Ordering Information

Consult a customer training schedule for information on course price and availability. Or call your local HP sales office or sales representative.

Consulting Services—Specialized Assistance

Consulting is a service delivered by a Systems Engineer, customized to your specific application and needs. It can range from helping you personalize HP training course material to your specific application; to developing techniques for addressing a unique or complex problem; to troubleshooting a system.

Consulting services are not a substitute for training, but rather a technical resource to augment the knowledge you gain from standard training programs. Two types of consulting services are available: unstructured assistance, billed on a daily basis, and standardized consulting services. Standard programs focus on commonly requested tasks and offer a fixed duration and price.

Ordering Information

You may request consulting from the nearest HP sales office or by conferring with your HP sales representative or an HP Systems Engineer. Charges for consulting are invoiced upon completion of the service or at the close of each calendar month if the service period extends beyond one month.

- Contracts to support desktop and systems owners
- Up-to-date information for managers, operators, programmers
- Flexible options to suit your budget

Software Support Programs—Personalized Assistance for Your Staff

Not only does HP help you get started using your equipment, but we continue to help by offering contractual services to answer your questions quickly in the months that follow. Other forms of software assistance, such as manual and software updates, are also conveniently packaged into contractual services. The variety of standardized services allows you to choose the level of support you need for continuing efficient operation.

Customer Support Service—Comprehensive Systems Support

HP systems software support begins even before the computer is ordered. During the selection process, a Systems Engineer (SE) provides technical advice to make sure the system, software products, and support will fit your business needs now and in the future. After you purchase Customer Support Service (CSS), an HP Systems Engineer is assigned to your account to help you with applications software development, resolve any software bugs and discrepancies, and preview new and enhanced HP software for your potential use. SE assistance is available to you via both a Phone-In Consulting Service (PICS) and on-site assistance.

In addition to valuable, personalized assistance from your SE, the CSS program includes one copy of HP software/firmware updates, plus updates and revisions for your HP software reference manuals. Periodic bulletins and newsletter provide information on current programming techniques, and items of general interest. These publications include:

- HP COMMUNICATOR-four times per year
- SOFTWARE STATUS BULLETIN-twice monthly, plus a cumulative quarterly issue
- SOFTWARE UPDATE NOTICE-quarterly, to HP 1000 customers

Software Information Service—Ongoing Support for Desktop and Personal Computer Users

System Information Service (SIS) is a software and firmware support service especially designed for owners of desktop and personal computers. It provides the technical and applications assistance needed by users and programmers for the effective and productive use of their HP computers. Early proficiency and confidence, during the first months of operation, can mean increased productivity and efficiency. Features of SIS include:

- Phone-In Consulting Service (PICS)
- Software Problem Reporting
- COMMUNICATOR
- Manual Updates

If you select SSS, you can use consulting services for supplemental assistance from a Systems Engineer.

Software Notification Service and Manual Update Service—Documentation for a Large Staff

Routinely available in both CSS and SSS described above, the Software Notification Service (SNS) is also available separately. If you have a large programming staff or multiple sites, SNS allows you to obtain multiple copies of periodic HP documentation.

Large programming staffs also frequently require multiple copies of manuals. Manual Update Service (MUS) is a valuable supplement to both CSS and SSS, since it relieves you of the administrative burden of monitoring and ordering manual updates.

Ordering Information

Software support services are normally purchased for a 12-month period, payable in advance, quarterly, or yearly as desired. The minimum purchase is three months. SNS and MUS are each purchased separately for a period of 12 months, renewable annually.

Detailed ordering information can be obtained from an HP Sales Representative or from the appropriate HP Computer System Price/Configuration Guide.

Benefit	Feature	CSS	SIS	SSS	SNS	MUS
Personal assistance	Account-Assigned SE On-Site SE Assistance PICS	• • •	•			
Software updating & Maintenance	Software/Firmware Updates Software Problem Reporting	• •	•	• •		
Application notes & tips	Communicator	•	•	•	•	
Status and documentation updates	Software Status Bulletin Software Update Notice (HP 1000) Manual Updates	• • •	• •	• • •	• •	•

Figure 1: Contractual Software Support

- Cost-effective maintenance agreements
- Flexible options for desktops and systems
- Installation services
- Flexible and comprehensive service plans
- Skilled engineers
- Fixed, monthly maintenance costs

Hardware Maintenance Agreement Services

All Hewlett-Packard computer products can be covered by one of HP's maintenance agreement services to assure continuous operation and maximum usefulness at a known monthly charge. These services are provided by HP-trained Customer Engineers. Service coverage hours and response times can be selected to fit your business or technical requirements.

System Maintenance Services—Customer Engineer Personally Responsible to Your Account

When you purchase an HP System Maintenance Agreement, a Customer Engineer is personally assigned to your account. When your system requires service, your CE responds within the length of time designated on your support contract, and stays on the job until your system is restored to normal operation.

Preventative maintenance is performed on a regular basis, scheduled in advance, to ensure that your HP computer system is maintained at its optimum performance specifications. If necessary, your Customer Engineer performs equipment adjustments or replaces worn-out parts.

Levels of system maintenance vary with your application needs. The variables are cost, hours of coverage, and CE response time. The Guaranteed Uptime Service is designed to provide a very high level of system availability. It ensures 99% uptime—money back guarantee—on the critical elements of your system, on-site maintenance services, and round-the-clock continuous coverage. It is currently available for the HP 3000 Series 40, 44, and 64 computers.

The Standard System Maintenance Agreement provides coverage from 8:00 AM to 9:00 PM, Monday through Fridays, excluding HP holidays. This coverage allows all scheduled maintenance services to be performed after normal working hours. For customers located within 100 miles of a Service Responsible Office, same-day service requests for unscheduled maintenance are received during a normal 8:00 AM to 5:00 PM shift.

For minimal interruption to your operations, you can increase the hours of coverage up to a maximum of 24 hours a day, seven days a week. Extended coverage can be tailored to the requirements of critical system uses.

A Basic System Maintenance Agreement plan provides economical coverage from 8:00 AM to 5:00 PM, Monday through Friday, excluding HP holidays. Next-day response is assured at your request for service if you are located within 100 miles of a Service Responsible Office.

Remote support is a standard feature of HP's system level support services for HP 3000 computer systems. Using remote diagnostics through a modem provided with your system, HP support engineers

monitor your system's operation and rapidly identify and resolve any problems. This special feature helps ensure greater system availability and allows us to focus worldwide resources on you.

Workstation Product Services

On-Site Service

The On-Site Product Service is an economical support program well suited for small workstation products, such as terminals, plotters, and desktop computers. Products placed under this service are maintained for about one-third less than under a Standard System Service.

A highly skilled Customer Engineer responds to your service call by the next working day if you are located within 100 miles of an HP service office. On-site service is provided beyond 100 miles with an increase in response time and cost. Specific hours of coverage are from 8:00 AM to 5:00 PM, Monday through Friday, excluding HP holidays.

Volume Repair Center Service

This service offers the lowest on-site support costs. It is available for most workstation products, providing you have a minimum of 25 eligible units. HP will make scheduled weekly visits to a single, central site which you may specify. This site must be located within 100 miles (160 kilometers) of a Primary Service Office.

Field Repair Center Service

The Field Repair Center Service is the lowest price alternative for hardware support covering HP computer products. At about one-half the cost of On-Site Product Service, HP's Field Repair Center performs remedial repairs on workstation products, including terminals, plotters, desktop computers, and printers. Maintenance is carried out by a Customer Engineer at your local Field Repair Center.

HP's Field Repair Service is ideal if you can operate without a unit for one to two weeks or if you have a backup unit available. It is preferable to per-incident charges, because HP covers all hardware problems resulting from normal product use for a low monthly fee, insuring you against expensive maintenance "surprises" after the 90-day warranty period.

Eligible products are shipped to local Field Repair Centers by you. They are repaired within three working days and returned via normal land freight by HP.

Dealer Repair Center

Many of HP's personal computing product dealers offer service on the computers and peripherals that they sell. They offer warranty repair and a variety of contractual and per-incident repair services.

Feature	Systems			On-Site Product	VRC	FRC
	Guaranteed Uptime	Standard	Basic			
Response Time	4-hrs.			Next day	Weekly Visit	3-day TA*
Coverage Hours	8 am-8 am	8 am-9 pm	8 am-5 pm	8 am-5 pm	8 am-5 pm	8 am-5 pm
Account-Assigned CE	○	○	○			
Scheduled PMs & ECs	○	○	○			
Work-to-Completion	○	○	○			
Add-on Installation	○	○	○			
Site Environmental Survey	○	○	○			
Extended Coverage Hours	N/A	○				

* Turnaround time

Figure 2 Hardware Maintenance Agreements Summary



Model 35030A Power Line Conditioner

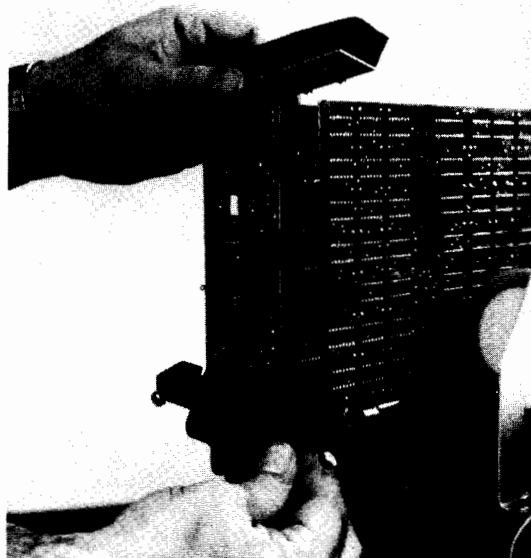

Modular Repair Strategy

System Installation Services

When you purchase an HP computer system, support services begin even before your system is installed. A Customer Engineer routinely provides site planning, site environmental survey, and installation services. These services ensure that your HP computer system is installed properly at an acceptable, designated site.

Your site survey may indicate a need for regulation of the power source. HP markets a power line conditioner to handle this need (described below).

Power Line Conditioner

The HP 35030A Power Line Conditioner provides protection from disturbances normally found on the incoming power line which affect system performance. It alternates noise and compensates for line voltage fluctuations. These combined functions protect your system against 99% of the typical power line disturbances.

Each conditioner has a capacity of 1.8 KVA. In many installations, more than one is necessary.

Easily installed, the Power Line Conditioner is recommended for protection against downtime in older buildings and areas where electrical storms occur.

Per-Incident Maintenance

Time and Materials is available for HP computer systems not covered by a maintenance agreement. When you purchase T&M Services, you receive a three-day response during coverage hours of 8:00 AM to 5:00 PM, Monday through Friday, excluding HP holidays. You will be billed for all travel, parts and labor used during the service call.

A Standard Repair Charge (STREP) is defined for selected products and includes all parts and labor. Products with a Standard Repair Charge may be returned to a Field Repair Center for repair.

Cooperative Support Services

While self-support is expensive, you may have a very large base of installed HP computer equipment and the technical expertise to make it cost-effective. If this is the case, HP has several Cooperative Support Services to meet your needs.

Customer Maintenance Training is available for the HP 1000, HP 3000, Series 40 and 44, HP desktop computers, and selected peripherals supported with these products. A balance of theory and practical experience is given to provide the skills needed to troubleshoot, repair, and maintain these products down to the major sub-assembly level.

Hardware Subscription Service (HSS) provides timely service information for maintaining products covered by Cooperative Support. This includes the *HP Computer Maintenance Newsletter*, *Service Notes*, and manual updates and revisions. The *HP Computer Maintenance Newsletter* addresses maintenance topics of general interest for service personnel. *Service Notes* provides technical information regarding specific changes in hardware maintenance. As changes and revisions are made to service manuals, updates are sent to keep these manuals at current levels.

Technical Assistance Service (TAS) provides access to HP technical resources through phone-in consulting. HSS is included with TAS. Account management is provided to assure that you are making the most effective use of all HP hardware services.

Warranty Services—90-Day Coverage

HP warrants its computer products against defects in material and workmanship for a period of 90 days. (For more information on the HP warranty, see the "Post-Sale Support Service" section of this catalog.)

HP Service Locations Worldwide

HP maintains computer sales and support offices in 39 countries. For a listing of addresses, see the back of this catalog.

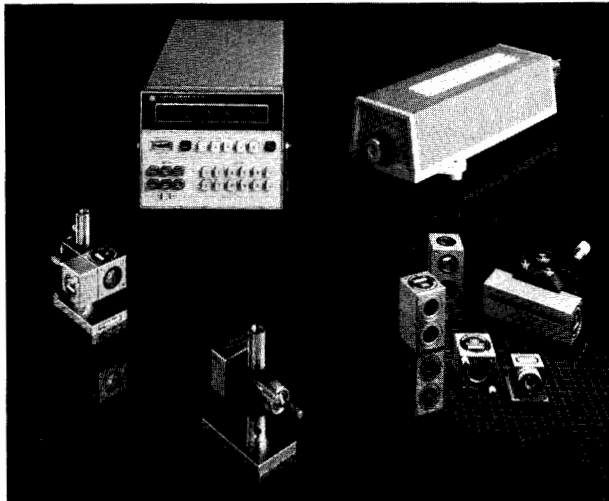
**5528A Laser Measurement System****Magnetic disc research and development****Machine tool calibration**

Hewlett-Packard Laser Measurement Systems fundamentally measure distance. A patented two-frequency design uses a low power Helium-Neon laser to obtain resolutions up to 0.01 micrometre (1.0 microinch) — over distances up to 50 metres (165 feet). The same basic principles are used to measure pitch, yaw, flatness, straightness, squareness, parallelism and velocity.

5528A Laser Measurement System

The HP 5528A Laser Measurement System offers a combination of accuracy, versatility and ease of use unmatched by any other system or method. Application examples are found everywhere:

- in R&D (non-contact measurements of critical components)
- in manufacturing (positioning of magnetic disc track writers)
- in fabrication (calibration of machine tools and coordinate measuring machines)
- in metrology (calibration of scales, gages and surface plates)

The laser makes an ideal standard for lab applications because it is unaffected by wear or aging. Its rugged construction and portability make it equally attractive for shop environments.

Modular Design

The basic system consists of the 5508A Measurement Display, the 5518A Laser Head and the 10753A Laser Tripod. System capabilities are determined by adding the optical components for the desired measurements. Optical components and their mounting fixtures are available in five convenient kits:

- 55280A Linear Measurement Kit (distance and velocity)
- 55281A Angular Optics Kit (pitch and yaw)
- 55282A Flatness Accessory Kit (flatness)
- 55283A Straightness Measurement Kit (straightness and parallelism)
- 10777A Optical Square (squareness)

In this way, the 5528A system can be configured to meet the needs of the present while offering economical expansion in the future.

Metrology System

System capabilities are also enhanced by the addition of a personal computer and software. The HP 55288S Dimensional Metrology Analysis System automatically collects, analyzes and plots data from the 5528A system. Special features include statistical analysis (mean and standard deviation) and data collection "on the fly".

Hard copy output is available in several forms. Data can be printed and plotted on the 85B's thermal printer. Report quality plots can be made on the optional 7470A Graphics Plotter.

The time saved over manually recording and calculating the results is enormous. These savings are especially important to fabrication shops, where machine tool errors are quickly identified and downtime is kept to a minimum.

Manual or Automatic Compensation

The absolute accuracy of distance measurements depends on the velocity of light in air. This is a function of temperature, pressure and relative humidity. Manual compensation consists of measuring these conditions, finding a compensation factor in a set of tables, and entering this number into the 5508A Measurement Display.

Automatic compensation is provided by the 10751A Air Sensor. This multi-purpose probe monitors air conditions and automatically updates the compensation factor. Automatic compensation is essential for continuously changing environments.

Distance measurements are also affected by the thermal expansion of the measured object. Its temperature can be manually entered into the 5508A Measurement Display, or automatically monitored and updated by one to three 10752A Material Temperature Sensors.



5528A Specifications

The following is a partial list of system specifications. Please refer to the technical data sheet for a complete list.

Specifications apply to a typical measurement with manual compensation and 15–25°C ambient temperature.

Laser: Helium-Neon. Continuous wave. Two-frequency. 1.0 mW output maximum.

Measurement velocity: 18.3 m/min (720 in/min) maximum.

Power: 100, 120, 220, 240 Vac (+5%, –10%), 48–66 Hz, 175 VA maximum.

Distance

Accuracy: ±0.1 part per million.

Resolution: 0.01 μm (1.0 μin).

Measurement range: 40 m (130 ft) typical.

Axial range: 50 m (165 ft) typical.

Update rate: 40/sec nominal.

Pitch and Yaw

Resolution: 0.1 arc-sec.

Measurement range: ±3600 arc-sec. ±36000 arc-sec with large angle correction.

Axial range: 15 m (50 ft) typical.

Straightness

Resolution: 0.01 μm (1.0 μin) using short range optics. 0.1 μm (10.0 μin) using long range optics.

Measurement range: ±1.5 mm (±0.06 in).

Axial range: 0.1–3.0 m (0.3–10 ft) typical using short range optics. 1.0–30 m (3.0–100 ft) typical using long range optics.

Ordering Information

5528A Laser Measurement System

5508A Measurement Display

5518A Laser Head

10751A Air Sensor

10752A Material Temperature Sensor

10753A Laser Tripod

10777A Optical Square

55280A Linear Measurement Kit

55281A Angular Optics Kit

55282A Flatness Accessory Kit

55283A Straightness Measurement Kit

55288S Dimensional Metrology Analysis System (includes 85B Personal Computer and software)

For complete specifications and ordering information, contact any Hewlett-Packard Sales Office.

5501A Laser Transducer

The HP 5501A Laser Transducer is the light source for a built-in positioning system. Customers can select from a variety of optics and electronics, and add only those components which solve their specific measurement or control problem. This flexibility benefits both end users and original equipment manufacturers (OEM's).

Applications can be found in three main areas:

- integrated circuit manufacturing (wafer steppers, projection aligners, electron beam machines and reticle/mask inspection equipment)
- disc manufacturing (magnetic and optical track writers)
- precision machining (diamond turning and coordinate measuring machines)

Optics

Distance is measured with one of three sets of optics:

- The 10702A Linear Interferometer and 10703A Linear Retroreflector are similar to the optics used in the 5528A system.
- The 10705A Single Beam Interferometer and 10704A Single Beam Retroreflector are used where space is severely limited, or for non-contact measurements.
- The 10706A Plane Mirror Interferometer is unaffected by pitch or yaw, and is ideal for monitoring position along two axes (for example, X-Y stages). It also can be used for non-contact measurements.

Each axis requires an interferometer, a reflector and a 10780A Receiver. Using the 10700A and 10701A Beam Splitters and the 10707A Beam Bender, a single 5501A Laser Transducer can monitor up to four axes at once.

Electronics

All signal processing and interfacing is performed by a series of printed circuit boards. The boards are housed in a 10740A Coupler, a rack-mountable enclosure with a backplane bus for system interconnection. The type and quantity of boards are determined by the customer's application and controller.

Customers can choose from several controller interfaces:

1. Binary — provides binary information to digital processors and controllers
2. Hewlett-Packard Interface Bus (HP-IB) — for use with HP personal and desktop computers
3. Closed Loop Control — provides high speed positioning feedback to closed loop control systems
4. English/Metric Pulse Output — provides microinch or micro-metre pulses to machine tool numerical controllers
5. Pulse Converter — provides TTL or A-Quad-B format pulses of quarter wavelength value

Compensation is provided by the 10756A Manual Compensator, or the 5510A Automatic Compensator and one to three 10563A Material Temperature Sensors. Other components include the 10783A Numeric Display, the 10708A Power Supply, and cables for measurement, reference and power.

5501A Specifications

The following is a partial list of system specifications. Please refer to the technical data sheet for a complete list.

Laser: Helium-Neon. Continuous wave. Two-frequency. 1.0 mW output maximum.

Accuracy: ±0.5 part per million.

Resolution: 0.16 μm (6.0 μin) using linear and single beam interferometers. 0.08 μm (3.0 μin) using plane mirror interferometer. Increased resolution available via resolution extension.

Range: 61 m (200 ft) maximum depending on system configuration and environment. Sum of axes for multi-axis system.

Axes: 4 maximum depending on system configuration and environment.

Measurement velocity: 18.3 m/min (720 in/min) maximum using linear and single beam interferometers. 9.1 m/min (360 in/min) maximum using plane mirror interferometer.

Power: 115 ±10%, 220 ±15% Vac, 48–63 Hz.

Ordering Information

(The following is a list of all optics and electronics. System configurations will vary with customer requirements.)

5501A Laser Transducer

Optics

10700A 33% Beam Splitter

10701A 50% Beam Splitter

10702A Linear Interferometer

10703A Linear Retroreflector

10704A Single Beam Retroreflector

10705A Single Beam Interferometer

10706A Plane Mirror Interferometer

10707A Beam Bender

Electronics

10708A Power Supply

10740A Coupler

10745A HP-IB Interface

10746A Binary Interface

10755B Compensation Interface

10760A Counter

10761A Multiplier

10762A Comparator

10763A English/Metric Pulse Output

10764B Fast Pulse Converter

10780A Receiver

10781A Pulse Converter

10783A Numeric Display

Compensation

5510A Automatic Compensator

10563A Material Temperature Sensor

10756A Manual Compensator

For complete specifications and ordering information, contact any Hewlett-Packard Sales Office.



PRESSURE & TEMPERATURE

Quartz Pressure Gauge, Pressure Recording System

Models 2813B, 2816A, 2820A

- 0.01 psi resolution (69 Pa)
- 0.025% full scale accuracy
- Direct surface readout

- Simple operation
- Long term stability
- 200-11000 PSIA range

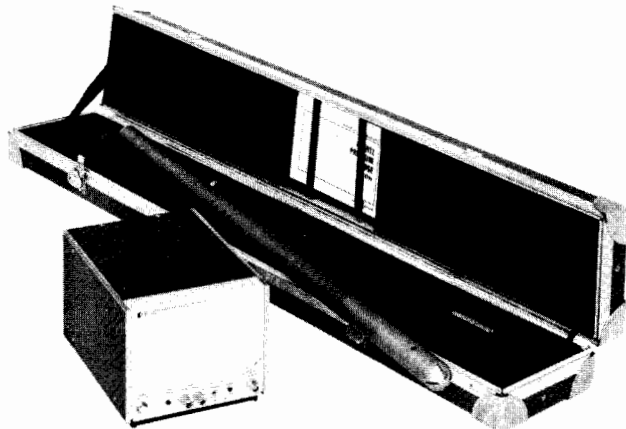

2816A Pressure Signal Processor,
2813B Quartz Pressure Probe

2813B, 2816A Description

The gauge consists of a 2813B Quartz Pressure Probe and a 2816A Pressure Signal Processor. A frequency signal proportional to pressure is transmitted from the bottom-hole pressure probe to the signal processor on the surface. It travels through a single-conductor, armored electric line. The processor conditions the pressure-related signal to drive a separate electronic frequency counter for direct readout.

0.01 psi Resolution at 11,000 psi (69 Pa @ 76 MPa)

The HP quartz pressure gauge measures wellbore pressure with a resolution of 0.01 psi over a dynamic range in excess of 11,000 psi. This capability makes it possible to measure pressure changes that cannot be detected with conventional gauges using bourdon tube transducers.

This ability to detect and record small pressure changes allows sophisticated test techniques to be used economically. For example, since the super-sensitive HP quartz pressure gauge can detect small pressure transients at observation wells, pulse tests can be conducted with extremely short pulse cycle times at the stimulus well. Because the shut-in time is reduced, the permeability and formation thickness between wells can be determined at a substantially lower cost.

With the gauge, pressure transients can be observed and recorded on the surface while the test is in progress. When the surface readout indicates the test is completed, the gauge can be retrieved immediately.

The quartz pressure gauge was specifically designed for pressure measurement in oil and gas wells and it is used by many oil companies and well service companies. However, its high resolution pressure measuring capability and rugged construction also make it ideally suited for oceanographic research and subterranean hydrodynamic studies

Field Case Study

The following plot shows the results of a test designed by Calvin J. Strobel, Mohinder S. Gulati and Henry J. Ramey, Jr. Note that the test was completed after only a few tenths of a psi pressure change.

Diagram courtesy of and copyrighted by Society of Petroleum Engineers of AIME, Paper No. SPE 5596

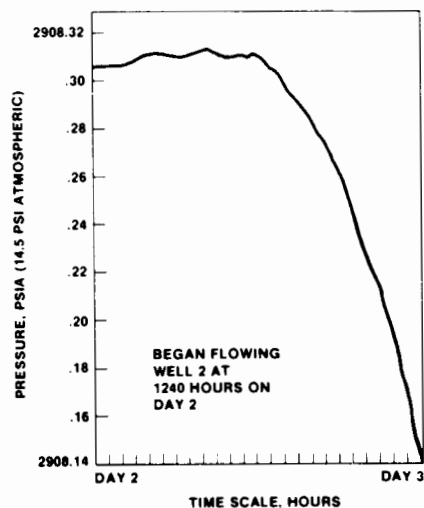

System Specifications

Sensitivity: (105 Hz/psi) 105 Hz/6.9 kPa nominal output of signal processor.

Probe operating pressure range: 0–82.7 MPa (0–12,000 psia.)

Probe operating temperature range: 0 to 150°C (32° to 302°F.)

Signal processor operating temperature range: 0° to 55°C (32° to 131°F.)

Calibrated pressure range: 1.4–75.8 MPa (200–11,000 psia.)

Resolution: 69 Pa (0.01 psi) when sampling for a 1-second period.

Repeatability: ±2.76 kPa (±0.4 psi) over entire range.

Accuracy (at thermal equilibrium) if Operating Temperature is Known

within 1° C (1.8° F): ±3.45 kPa or ±0.025% of reading (±0.5 psi or ±0.025% of reading.)

within 10° C (18° F): ±6.89 kPa or ±0.1% of reading (±1 psi or ±0.1% of reading.)

within 20° C (36° F): ±34.5 kPa or ±0.25% of reading (±5 psi or ±0.25% of reading.)

Dimensions and Weights

2813B Probe: 36.5 mm (1.4 in.) OD by 1000 mm (39.4 in.) long. Weight: 5.0 kg (11 lb.).

2816A Signal Processor: 154 mm H x 197 mm W x 279 mm D (6.1" x 7.8" x 11").

2813B Quartz Pressure Probe

2816A Pressure Signal Processor

PRESSURE & TEMPERATURE

Quartz Thermometer

Model 2804A

647



- $\pm 0.04^\circ\text{C}$ absolute accuracy
- 0.0001°C or 0.001°F resolution
- -80° to $+250^\circ\text{C}$ range
- Display of absolute or differential temperature
- Flexible HP-IB system interface
- Variable resolution analog output
- Easy ice point or triple point adjustment

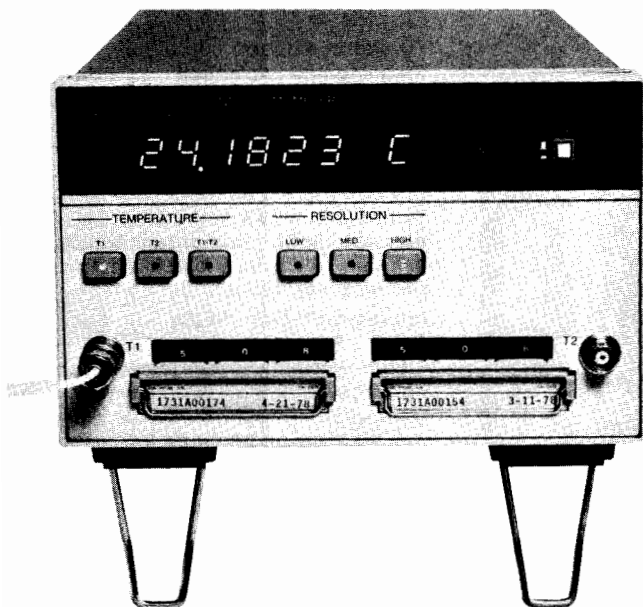

The 2804A Quartz Thermometer allows you to easily measure temperature with exceptionally high accuracy and resolution. Absolute accuracy is ± 40 millidegrees Celsius over the range of -50°C to 150°C , NBS traceable to IPTS-68. The useable resolution of 0.0001°C allows you to measure temperature changes that could not be detected by other digital thermometers.

The 2804A can be used with one or two temperature sensing probes. The temperature of either probe, or their difference, can be measured and displayed under pushbutton control. Display resolution is selectable from 0.01 to 0.0001°C (0.1 to 0.001°F) by pushbuttons. An internal switch allows you to easily select measurement in the Celsius or Fahrenheit temperature scale.

Temperature is measured and displayed automatically with the microprocessor and electronics provided in the 2804A package. There is no need to balance a bridge, perform calculations using resistance- or voltage-temperature tables or curves, or to use calibration correction tables. The only adjustment necessary to remove effects of thermal history on the sensor is a simple ice point or triple point calibration adjustment using the front panel thumbwheel switches.

How It Works

The 2804A temperature sensor is a quartz crystal whose precise angle of cut gives a stable and repeatable relationship between resonant frequency and temperature. Each quartz sensor is individually calibrated at the factory over the full temperature range. The calibration data for each sensor is processed and stored in a calibration module which is supplied with the probe.

In operation, a microprocessor in the thermometer performs the complex control and calculation operations to accurately measure temperature from the quartz sensor frequency and probe calibration information in the calibration module. The microprocessor also performs self-checks to detect fault conditions. If a problem occurs that would give an improper measurement, an error message is displayed to indicate the source of the problem.

System Oriented Design

The HP-IB (standard) offers you a simple, yet flexible, way to connect the Quartz Thermometer to either an HP computing controller or printer. Temperature data can easily be sent to a calculator or computer for processing and recording. All front panel controls can be operated automatically by commands sent on the bus.

The analog output (standard) converts any three consecutive digits to a voltage between 0 and $+10$ volts to drive a chart recorder. Front panel controls allow easy adjustment of pen zero and full scale as well as normal or offset (center-zero) operation. Any three digits can be selected for conversion allowing you to change the full scale value on the recorder.

2804A Specifications

Performance

Range: -80 to 250°C .

Absolute accuracy: 2804A with 18110A, 18111A, 18112A or 18117A Quartz Probe —

$\pm 0.040^\circ\text{C}$ from -50 to 150°C

$\pm 0.075^\circ\text{C}$ from -80 to 250°C

NBS traceable to IPTS-68

Resolution: three levels can be selected:

Level of selection	Resolution		Nominal time between readings in seconds	
	$^\circ\text{C}$	$^\circ\text{F}$	T1 or T2	T1 - T2
Low	0.01	0.1	0.1	0.2
Medium	0.001	0.01	1	2
High	0.0001	0.001	10	20

General

Display: 7 digit LED with polarity, decimal, and degree C or F annunciator.

Probes: a variety of probes are available for use with the 2804A. Refer to the data sheet for specifications and sheath configurations.

Power Required

100, 120, 220, or 240 VAC, $+5\%$ – 10% , 48 to 66 Hz, <30 VA.

Accessories and Probes

18107A External Oscillator

18108A Line Amplifier

18110A Laboratory Probe and cal module, 25 mm (1")

18111A Laboratory Probe and cal module, 230 mm (9.1")

18112A Laboratory Probe and cal module, 460 mm (18.1")

18115A Heavy Duty Probe and cal module, 30 mm (1.2")

18116A Heavy Duty Probe and cal module, 100 mm (3.9")

18117A Heavy Duty Probe and cal module, 180 mm (7.1")

2804A Quartz Thermometer

INSTRUMENT SUPPORT

General Information



Introduction

When Performance Must be Measured by Results. . .

Success in today's business environment depends on quickly obtaining high productivity from people and equipment. Selecting the right instrument system is essential to achieving proper results. Inefficient use of that system, however, can severely hamper your success.

. . . Results Can be Assured by Support

At Hewlett-Packard we understand that the efficient application of an instrument system involves much more than just purchasing the best equipment. That's why we are a world leader in instrument support services.

We want you to be successful with your HP instrumentation. HP offers applications and training support to help you obtain full use of your instrumentation's capabilities, hardware support to help maximize your system's uptime, and software support to keep your system software current and productive. Assured use of HP instrument support services throughout the life of your application can give you a competitive edge through increased productivity.

HP's Complete Solution

We deliver support solutions tailored to your productivity needs. Support allows you to quickly realize the full performance potential of your HP equipment, to maximize its uptime and to prolong its useful life. Our support commitment starts before you purchase any equipment and continues long after your instruments have been delivered. When you purchase HP equipment and sup-

port together, you are purchasing a complete productivity solution.

HP "Engineered" Support

The same high level of engineering excellence that HP commits to the development of advanced instrumentation products also goes into creating high quality support services. This means investment in the engineering of procedures to measure and improve performance, investment in product technology and training, and investment in capital equipment and systems to effectively deliver support worldwide.

Personalized Attention

Hewlett-Packard's support organization is a worldwide network of engineers and technicians dedicated to delivering personalized support. To aid in planning your instrument system and its use, we offer the consulting and training expertise of an experienced HP Systems Engineer. To aid in installation and ongoing maintenance and calibration of systems and system components, we offer the knowledge of an HP Customer Engineer. Together with your primary HP contact, your Sales Representative, these three individuals comprise the team that can give you the solutions you need to achieve the results you desire.

The Application Life Cycle

Your system implementation can be viewed as an application "life cycle". Each step of this cycle provides an opportunity to improve the use of your instruments to increase productivity.

Whether you are in the decision, implementation or sustained operation phase of this application life cycle, HP can provide the

the tools, knowledge and support to ensure success. To see just how our services can help, let's take a closer look at the application life cycle.

Decision Phase Planning and Evaluation

An HP account team will work with you to design an application based instrument system that will meet your immediate as well as long term needs. They can provide assistance in evaluating the full costs of ownership so that you can make a more informed purchase decision. The HP account team is dedicated to helping you build a solid foundation for a successful application.

Implementation Phase Getting Ready

From helping you plan for your system's installation to training your new system's operators, HP support works for you. Our training programs are taught by product specialists and are designed to teach key concepts and procedures using lab intensive, hands-on exercises as well as prepared text and lectures. Training is available through standard courses or through customized assistance.

When the System Arrives

Your HP Customer Engineer will advise on proper site planning and preparation to ensure smooth system installation, including hardware set-up, software configuration and functional testing. Or, if you are configuring your own test system with HP equipment, we can assist in developing system functional tests.

Putting the System to Productive Use

Effective use of your system is achieved by minimizing the time to productive output and maximizing system performance. In addition to our standard and custom training, we can also assist in the development, debugging and implementation of your application software. For some systems and applications we will even develop application software for you—all so that you can more quickly achieve productive use of your HP instrumentation.

Sustained Operation Phase Keeping the System Productive

Keeping your system running productively is the goal of HP hardware support. Our wide selection of hardware maintenance services allow you to choose the level of support that best meets your needs. Whether you require system or component level support, on-site or fast return-to-HP service, we have the right support for you. Both maintenance and calibration services are available on a per-incident basis or in cost-effective annual agreements. Or, if you prefer to manage your own maintenance and calibration program, HP can provide extensive backup support.

Software is an integral part of your system investment and an important facet of long-term productivity. HP software support can provide personal access to a System Engineer, timely software updates, reference manual changes and periodic bulletins to keep your software up-to-date and trouble free. Or, if you need little personal support, we can provide software revisions and system specific information to help keep you productive. These products are currently available on a limited basis for specific systems.



Extending System Life

System Expansion or Reconfiguration • Hardware Upgrades and Refurbishment • System Software Upgrades • Application Software Performance Improvement • System Replacement

Keeping the System Productive

System Calibration & Preventative Maintenance • Remedial Maintenance • System Software Updates and Support • Supplies Availability

Planning and Evaluation

Needs Analysis and Requirements Definition • Authorization and Financing • System and Support Specifications • Cost of Ownership Analysis • Vendor Selection • Equipment Order

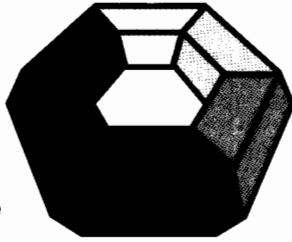

Getting Ready

Implementation Planning • Application and Operator Training • Site Survey and Preparation • Information Gathering

When the System Arrives

Hardware & Software Delivery • Racking, Cabling and Installation • Functional Test Design and Coding

Putting the System to Productive Use

Application & Test Design • Program Coding • Program and Test Documentation • Fixture Installation • Staff Training

Extending System Life

Keeping your system productive for as long as possible helps prolong the value of your investment. HP supports you at this stage of your application life cycle with a number of useful services.

HP offers software updates and enhancements as a standard feature of contractual software support. As system performance requirements change, new or replacement system modules can be purchased to update your hardware. Application software performance can be improved when necessary and we offer major software upgrades as standard products.

In addition, HP will support systems after manufacture ceases. Refurbishment of components is available and may be recommended over time. HP will also work with you to provide service staff training and suggest parts stocking procedures to extend the time frame over which your instruments can be maintained.

Make HP Your Partner in Productivity

Hewlett-Packard can be your partner in test and measurement success. From your first consideration of a hardware purchase through the entire life cycle of your instrumentation, HP stands behind your success with a complete range of worldwide support services. Choose Hewlett-Packard as your instrument partner and you are assured of state-of-the-art hardware, software and support.

Ordering Support is Easy

If you wish to design your own support program you may select the services you need from the product descriptions which follow. Or, if you prefer HP to configure a support plan for you, just contact your local HP sales office and an HP sales representative will provide a plan that fits your needs.

Training Courses

Training Can be Important to Your Success

Proper knowledge of measurement techniques and instrument capabilities will make



you more productive. With HP instrument training you can gain a competitive advantage by minimizing start-up delays due to insufficient understanding of your system or its operation. Training can also acquaint you with new applications and operating techniques which can significantly improve your productivity.

Instrument training courses are an important element in HP's support of your application life cycle. Your training can begin before your system arrives by attending a course at a local HP facility. Or, we will come to your site and train you using your HP instrumentation. Either way you receive a cost-effective method of quickly acquiring the knowledge it takes to sustain success with your system.

HP offers a wide variety of courses around the world. Taught by experienced HP Systems Engineers, the courses are carefully designed to teach key concepts and procedures using intensive hands-on exercises as well as prepared text and lectures. In addition, the course offerings are concentrated in related fields for maximum utility.

Choose from the courses below, or contact your local HP office for a training schedule (part number 5953-8221(D)) that includes complete course descriptions, training locations, prices and dates.

Courses

HP-IB Systems Oriented

The courses below will help you integrate various HP instruments into your own HP-IB configured system, and then help you gain maximum value from their operation.

HP-IB Instrument System Training With Model 26 Controllers

This four-day lab-oriented course will enable you to set up and customize an HP-IB system to do various automatic test or measurement/control tasks. You will learn to create and document HP-IB programs by applying structured programming techniques using Series 200 Desktop Computers. To attend this course, ask for HP 50011A training.

HP 8566A/8568A Spectrum Analyzer Operation Course

This four-day program will help you accelerate the integration of your 8566A or 8568A Spectrum Analyzer into automatic test systems. You will learn to effectively use signal acquisition and processing capabilities; how to analyze and optimize accuracy, sensitivity, dynamic range and resolution in a system environment. The course covers manual and remote operation, signal measurement and advanced operation. For your system's spectrum analysis needs, ask for HP 8566A/8568A Spectrum Analyzer Operation Course.

HP 1980B Waveform Measurement System Training

This two-day lab-oriented course will speed your ability to make completely automated time domain measurements using the HP 1980B Oscilloscope in conjunction with the 19800A Waveform Measurement Library and HP 9826/9836 controllers. You will learn measurement algorithms and data structures that measure waveform voltage and timing parameters and be able to create custom application programs for waveform measurements and comparison/tolerance tests with the system. Ask for course HP 1980B+24A.

HP 6942A Multiprogrammer User's Course

This three-day course teaches you how to make measurements and perform stimulus/response or control for automation applications using the HP 6942A Multiprogrammer and the HP 85 computer as a controller. The course emphasizes practical applications and extensive hands on experience with this important system component and will be of most value to the automatic test engineer or test system programmer. Ask for the HP 6942A Multiprogrammer User's Course.

Logic Related Courses

Today's microprocessor technology demands high logic development and analysis skills. HP offers a variety of courses to meet your needs in this important technology.

HP 64000 Logic Development System Training

To increase your productivity with the 64000 Logic Development System, HP offers a group of modular courses. The 64000 System Overview Module teaches general system operation and capabilities and is a prerequisite for the other modules. The 16-Bit Emulation Training Module presents the technical details of emulation and helps you



INSTRUMENT SUPPORT

Training, Application and Software Support

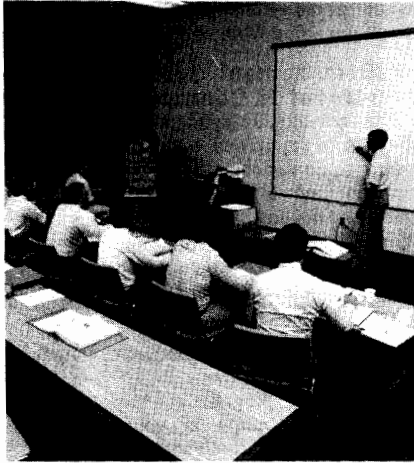

become proficient quickly. The Logic System Analysis Training Module covers advanced software and hardware analysis techniques possible with the 64000 System. The User Definable Assembler Training Module presents the structure and building of assemblers and linkers for the 64000 System. Together the modules that comprise HP 64000 Logic Development System Training will help you increase the productive use of your 64000 System in your application.

HP 64000 System Pascal Programming

HP offers two courses to help you use Pascal on your 64000 System. The first, 64000 System Pascal Programming Course, is a three-day introduction to the language using HOST Pascal. The second, Pascal 64000 Microprocessors Course is a two-day applications oriented session designed to improve microprocessor productivity using Pascal. If you are a hardware or software engineer who wants to use Pascal with your 64000 System, ask for HP's 64000 System Pascal Programming Course.

Advanced Timing/Hardware Analysis Training

This one-day course teaches the concepts, applications and configurations of timing analysis using an HP 64600S 8-channel timing analyzer. You will increase your ability to identify and solve timing related problems, understand the interaction of the timing module with the state module, and the theories and effects of skew and asynchronous triggering. Ask for HP 64600A+24F Advanced Timing/Hardware Analysis Training.

Advanced State/Software Analysis Training

This one-day course teaches practical applications of the HP 64620S state/software analyzer. You will learn concepts, applications and ideas which are new to previous generation logic analyzers, as well as proper configuration and interfacing needs of the 64620S. Also covered are use of "trace list" and "overview" modes, techniques for symbolic tracing, and performance measurements. Ask for HP 64620S+24F Advanced State/Software Training.

HP 1630 Logic Analysis Measurement Techniques

This one-day lab-intensive course offers a systematic approach to problem solving using state, timing and software performance analysis with the HP 1630 logic analyzer. You will learn to match appropriate measurement techniques to specific problems using the full interactive state and timing capabilities of the 1630. Ask for HP 1630A/D+24A Logic Analysis Measurement Techniques.

Board Test Course

The accurate testing of IC boards is crucial to the productivity of many businesses. HP offers board test courses designed to enhance your use of HP board test equipment.

HP 3060A, 3061A, 3062A User's Course

This ten-day course presents the knowledge necessary for testing analog and hybrid circuits with the HP 3060A/61A/62A board test systems. Included is software instruction of the HP Series 200 Desktop Computer's language (HPL), the 3061A/62A's Board Test Language (BTL) and the In-Circuit Program Generator (IPG). Time is spent on testing philosophies involving shorts, in-circuit and functional testing, as well as semiconductor tests, guarding, phase-synchronous detection, digital testing and signature analysis. You will practice by programming and testing three PC boards of varying complexity. Ask for HP 3060A/61A/62A Board Test System User's Course.

HP 3065 Board Test System User Training

This two-week course provides detailed programming and operating instruction for the HP 3065 board test system. Topics covered include system software and program development, board test topology, in-circuit testing of analog and digital boards, use of the digital scanner hardware, digital test structure and digital test language. Also included in this intensive course are reviews of BT BASIC, test optimization, fixturing, data logging, networking links and IPG II. Ask for HP 3065C+24D Board Test System User Training.

HP 3060A Enhancement Training

This half-day course will shorten your start-up time using the HP Series 200 controller enhancement to your HP 3060A board test system. You will learn to use the new board test language (BTL) and In-Circuit Program Generator (IPG) features, and specific instruction is given on program transfer and editing on the Series 200. Ask for HP 44854+24A HP 3060A Enhancement Training.

Additional Courses

HP offers a number of other courses to help you use your HP equipment in the most effective way to meet your own particular application needs.

HP 8409 Series Automatic Network Analyzer Training Course

This four-day course will give you an in-depth understanding of the HP 8409 and



will provide you with all the skills necessary to take full advantage of its capabilities. You will learn network measurement basics and automatic measurement fundamentals as well as one and two-port measurement techniques and modelling concepts. Standard system software, software modification and specialized measurement procedures are also presented. Ask for HP 8409 Series Automatic Network Analyzer's User Training course.

4955A Protocol Analyzer User Training

This one-day lab-intensive course is built around the concept of a short tutorial on specific troubleshooting techniques, immediately reinforced by gaining hands-on experience using the HP 4955A Protocol Analyzer. You will learn to configure the 4955A for character-oriented protocols, byte-oriented protocols and custom data codes, plus learn to write BASIC programs for calculating network statistics and providing custom displays. In addition, you will learn to design and enter Level 2/Level 3 triggers, use multiple triggers simultaneously and simulate DTE or DCE. Ask for HP 49551+24A Protocol Analyzer User Training.

HP 5528A Laser Measurement System Training

Two one-day courses are available to quickly familiarize you with laser fundamentals and HP 5528A measurement techniques. The first day will give you the knowledge to properly install optics, align the laser beam to optic travel and set up the display for appropriate measurements, in addition to making accurate distance and angle measurements. The second day will teach you to make straightness and squareness measurements as well as how to manually and automatically record data. Ask for HP 55280A+24A and 55283A+42A Laser Measurement System Training.

Ordering Information

To enroll in any of the courses listed here, or to find out more information on these and other instrument courses offered by HP, just contact your local HP sales office. They will provide you with a schedule of local classes and complete registration information. You can also order a complete catalog of instrument training classes by requesting publication number 5953-8221 (D).

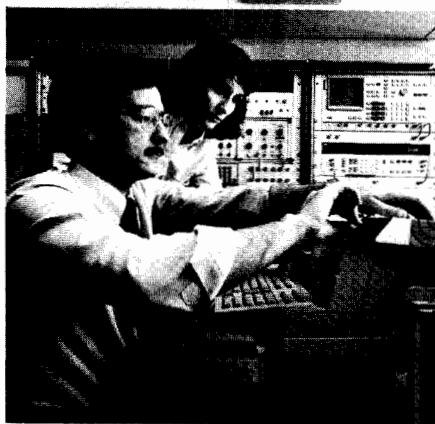

Application Support

Helping You be Successful With Your System

When you purchase a measurement or test system you want to make sure that the pay-back starts quickly. HP's Instrument Application Service (HP 50600B) provides assistance that allows you to develop your staff and ensure the effective use of your system. Instrument Application Services (IAS) feature the expertise of a Hewlett-Packard Systems Engineer (SE) trained in your application area and can be tailored to meet your own specific needs.

Customized Training Improves Utilization

If your application requires training needs that fall outside the scope of HP's formal training courses, our Systems Engineering Organization can provide customized training to fit the demands of your particular application.

An HP SE skilled in your application area will work with you to determine the topics to be covered and the structure of the material he will present. The training can cover basic system start-up and operational techniques or can include more advanced material on your application. Each day of SE training could save your staff several days of start-up time and could improve your overall capabilities and operating efficiency.

Application Support Speeds Solutions

Even if you require assistance beyond training, IAS can help. Under IAS an HP SE can provide application support designed to help you achieve the highest possible level of success with your HP ATE, data acquisition board test, logic development or other system.

System Level Expertise Increases Productivity

If you have an existing measurement or test system and have partially or fully developed software or fixturing, IAS can help you fine tune the final implementation. An SE will come to your site and work with you to analyze system performance parameters and make recommendations to help optimize performance.

Interactive Help

The interactive nature of IAS allows for maximum flexibility to improve your productivity. Since your needs determine the best mix of training, application advice or performance evaluation, an initial discussion with your HP representative will help define how IAS can benefit you. Our SE will then perform any research and preparation necessary and will come to your site to assist you or your designated system contact or do any training required.

How to Order

The services provided by IAS are flexible and can be purchased in increments of one day (plus preparation time) or in larger blocks spaced out over longer periods. You may request IAS from the nearest HP sales office or by conferring with your HP Instrument Sales Representative or System Engineer. They will acquaint you with the procedure for defining your project and ordering the service.

Software Support

Increase System Effectiveness

Your investment in system software doesn't end with the purchase of an instrument system. It continues as you develop or improve programs specific to your application needs. Through Hewlett-Packard's software support services (available for specific instrument systems) you will gain valuable tools to keep your system software and programmers operating at peak efficiency.

Real Benefits

With software support your programmers stay current with changes in system software. They can quickly implement new software enhancements or fixes to improve system productivity. And, there are no delays in getting new versions of software because HP will automatically send you copies as they become available.

Software support services can also help your programmers save time during their test development by providing access to an HP Systems Engineer for help in answering questions about the system software.

Above all, software support can help you stay competitive. Because software support keeps you constantly informed of software changes, additions and enhancements, you can be sure that your system's operation is not becoming outdated.

Flexible Services

Because we realize that individual needs vary between users as well as over time, HP offers two types of software support. You can choose the level of support that best fits your needs.

If you want to keep current with developments in your system's software and are experienced on the use and operation of the software, then System Software Support (SSS) is for you. With SSS you will automatically receive Software Updates which include improvements to software performance, additional software elements, resolution of specific anomalies, and increases in software capabilities. You will also get Reference Manual Updates as well as Software Status Bulletins and a User's Newsletter, all of which contain information on the use, application, configuration and developments in the HP software.

Should you require additional help with your system software, our Software Information Service (SIS) provides all the features of SSS, but also delivers prompt personal assistance from HP's Systems Engineering Organization.

SIS provides priority telephone access to an HP Systems Engineer. During normal working hours, you can get personal support in the following areas: identification of specific software problems, advice on resolving specific software programming difficulties, and specific software operation and documentation tips.

How to Order

Let HP help you make the best use of your system through software support. Software support products are purchased for an initial 12-month period for certain specified systems, and are billable quarterly or yearly in advance, as desired. Details on software support availability and on ordering software support may be obtained from the nearest HP Sales Office or by contacting your HP Instrument Sales Representative.



Training Alternatives

With Hewlett-Packard's extensive product line and worldwide customer mix there are two main avenues for technical customer training. These are live training sessions and videotapes. Live training sessions fall into three subcategories: applications, service and tutorial. Application seminars aimed at increasing your utilization of general purpose test instrumentation are often available at no charge. On the other hand seminars on the operation of dedicated systems are more specific in nature and generally have a fee for tuition. Service seminars are available on a supply and demand basis and also have a tuition fee. For detailed information on all HP seminars contact your Hewlett-Packard field engineer or call the Hewlett-Packard sales office nearest you—see page 681.

HP Videotapes

A Better Way to Learn

The videotapes listed in this catalog have been produced by the Hewlett-Packard Television Network. These programs communicate important technical information. Their primary purpose is to clarify a variety of complex concepts and provide training for the operation and maintenance of a wide range of electronics equipment. Therefore, they offer detailed, practical and well-presented working information which has proven to be invaluable for technical training within Hewlett-Packard. We are sure you also will find the tapes useful for your own professional applications because you'll find they make it easier for your technical people to understand, use and repair your own valuable equipment.

Practical Transistor Series

The widely used Practical Transistor Series is a definitive, 15-cassette excursion into

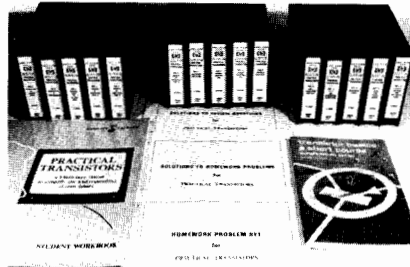

the exceedingly important (and mysterious) world of transistors. As outlined below, each highly informative program in the wide-ranging series is primarily concerned with examining the many practical aspects of transistors rather than just dwelling on theory and math. The end result, after viewing this popular series, will be a deeper working understanding of transistors which will make maintenance and trouble-shooting problems far easier and more efficient. The series is therefore highly recommended for electronics students, service personnel and engineers.

A supplementary textbook by transistor authority George Stanley Jr. (who also hosts the series), plus a complete set of homework problems and answers, is included with the nearly nine hours of videotaped material.*

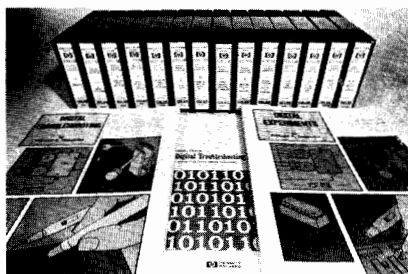

Tapes 1-15, BW, time: 8 hrs., 53 mins.

Stock No:

90100A	1/2" VHS (SP)	NTSC
90100B	1/2" BETA I	NTSC
90100D	3/4" UMATIC	NTSC
90100C	1/2" VHS (SP)	PAL
90100E	1/2" BETA	PAL
90100F	3/4" UMATIC	PAL

Digital Trouble-Shooting Series

This course was designed, developed, and made for technicians. It provides an appropriate path from transistors to digital electronics. It also can be used as a refresher course. Equivalent in coverage to a college term of 13 weeks, Digital Troubleshooting is presented in color on 14 videocassettes having a total running time of 5 hours and 31 minutes. The lab demonstrations shown in video are from the workbook included with the series. Also included is a 180 page text and a study guide.

There is ample use of reinforcement in the presentation and in the self-scoring quizzes at the end of most of the modules.

Tapes 1-14 time: 5 hours, 31 minutes

Stock No:

90420A	1/2" VHS(SP)	NTSC
90420B	1/2" BETA I	NTSC
90420D	3/4" UMATIC	NTSC
90420C	1/2" VHS(SP)	PAL
90420E	1/2" BETA	PAL
90420F	3/4" UMATIC	PAL

Lab experiments are used to reinforce learning. They require access to a digital experimenter's kit such as the HP5035T Logic Lab (not included with series).

Understanding Microprocessors

Developed to train HP technicians, this course provides a practical introduction to microprocessor systems.



Microprocessors are now found in the most familiar places: automobiles, kitchen appliances, toys, and home entertainment devices, as well as in modern electronic instruments. All electronic technicians must soon be able to trouble-shoot and repair this type of equipment.

Understanding Microprocessors consists of 5 videocassette lessons in color, a textbook/experiment book, and a study guide. Each lesson concludes with a self-scoring quiz. The HP 5036A Microprocessor Lab (not included) is recommended for performing assigned experiments. The lessons are aimed at technicians who already are able to trouble-shoot and repair equipment using digital circuitry. After completing this module, they should be ready for more advanced microprocessor trouble-shooting modules.

Tapes 1-5, time: 2 hours, 46 minutes

Stock No:

90301RA	1/2" VHS(SP)	NTSC
90301RB	1/2" BETA I	NTSC
90301RD	3/4" UMATIC	NTSC
90301RC	1/2" VHS(SP)	PAL
90301RE	1/2" BETA	PAL
90301RF	3/4" UMATIC	PAL

What Is a Microprocessor?

Lesson 1

This first lesson reviews the history of computers and microprocessor systems and provides an overview of the microprocessor video series. Microprocessors are graphically demonstrated along with the elements of microprocessor systems. Lesson 1 concludes with a summary and a short self-scoring quiz.

Time: 17 minutes

Stock No:

90302RA	1/2" VHS(SP)	NTSC
90302RB	1/2" BETA I	NTSC
90302RD	3/4" UMATIC	NTSC
90302RC	1/2" VHS(SP)	PAL
90302RE	1/2" BETA	PAL
90302RF	3/4" UMATIC	PAL

Analog vs Digital Systems

Lesson 2

The difference between analog and digital systems is never more apparent than when studying microprocessor systems. This program clearly describes these differences and goes on to explain the three-state bus concept, talkers, and listeners, and bus trouble-shooting techniques.

Time: 40 minutes

Stock No:

90303RA	1/2" VHS (SP)	NTSC
90303RB	1/2" BETA I	NTSC
90303RD	3/4" UMATIC	NTSC
90303RC	1/2" VHS (SP)	PAL
90303RE	1/2" BETA	PAL
90303RF	3/4" UMATIC	PAL

Introduction to Programming

Lesson 3

This brief review of programming defines a few terms, describes what a program is, why programs are necessary, and how to develop them. The concepts of low and high level programs and a review precede the self-scoring quiz.

Time: 19 minutes

Stock No:

90304RA	1/2" VHS (SP)	NTSC
---------	---------------	------

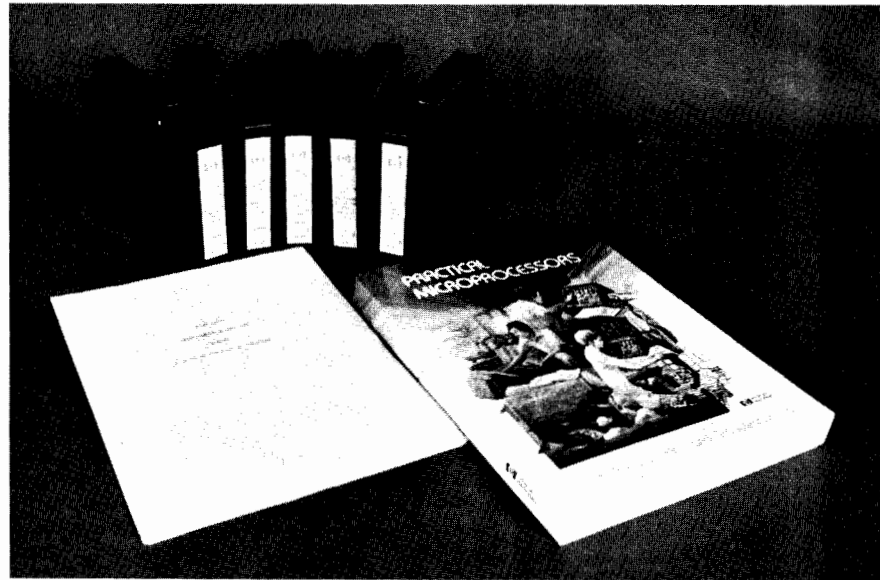

90304RB	1/2" BETA I	NTSC
90304RD	3/4" UMATIC	NTSC
90304RC	1/2" VHS (SP)	PAL
90304RE	1/2" BETA	PAL
90304RF	3/4" UMATIC	PAL

Processor Registers and Instruction Set

Lesson 4

This lesson describes the many registers contained on the microprocessor chip, including their uses in the operational sequence: fetch, execute and increment. The instruction set is described briefly to enable the viewer to follow the succeeding lessons.

Time: 51 minutes

Stock No:

90305RA	1/2" VHS (SP)	NTSC
90305RB	1/2" BETA I	NTSC
90305RD	3/4" UMATIC	NTSC
90305RC	1/2" VHS (SP)	PAL
90305RE	1/2" BETA	PAL
90305RF	3/4" UMATIC	PAL

Simple Assembly Programming

Lesson 5

Using the knowledge of the instruction set, the viewer is led through simple examples of assembly language programs. Translating the assembly language into machine language is shown, as well as how the program is stored in memory and executed by the processor. A program review precedes the self-scoring quiz.

Time: 40 minutes

Stock No:

90306RA	1/2" VHS (SP)	NTSC
90306RB	1/2" BETA I	NTSC
90306RD	3/4" UMATIC	NTSC
90306RC	1/2" VHS (SP)	PAL
90306RE	1/2" BETA	PAL
90306RF	3/4" UMATIC	PAL

Stock

No.	Books
05036-	Practical Microprocessors
90003	Textbook/Lab Workbook
	Understanding
	Microprocessors
90301RG	Study Guide

Microprocessor Fundamentals

Microprocessor Fundamentals is the second module in the Microprocessor Trouble-shooting Series. It consists of 11 videocassette lessons and includes 1 copy of Practical Microprocessors (textbook/experiment book) 05036-90003, and a study guide.

Tapes 1-11, Time 3 hours, 29 minutes

Stock No:

90307RA	1/2" VHS (SP)	NTSC
90307RB	1/2" BETA I	NTSC
90307RD	3/4" UMATIC	NTSC
90307RC	1/2" VHS (SP)	PAL
90307RE	1/2" BETA	PAL
90307RF	3/4" UMATIC	PAL

Algorithmic State Machines

This first lesson of Microprocessor Fundamentals describes algorithmic state machines as they appear around us. As the complexity of each succeeding algorithmic state machine is increased the program relates this complexity to the instruction decoder of a microprocessor. A self-scoring quiz completes the lesson.

Time: 36 minutes

Stock No:

90308RA	1/2" VHS (SP)	NTSC
90308RB	1/2" BETA I	NTSC
90308RD	3/4" UMATIC	NTSC
90308RC	1/2" VHS (SP)	PAL
90308RE	1/2" BETA	PAL
90308RF	3/4" UMATIC	PAL

Basic Design and Terminology of Microcomputers

Lesson 2

This lesson reviews the terms needed to understand microprocessors. Appliance and peripherals are discussed next, giving the student an overview of how microcomputers are used in modern electronics. The short self-scoring quiz gives a thorough review for the student.

Time: 26 minutes

Stock No:

90309RA	1/2" VHS(SP)	NTSC
90309RB	1/2" BETA I	NTSC
90309RD	3/4" UMATIC	NTSC
90309RC	1/2" VHS(SP)	PAL
90309RE	1/2" BETA	PAL
90309RF	3/4" UMATIC	PAL



Microprocessor Internal Hardware Lesson 3

This videocassette reviews the three main sections of the 8085 Microprocessor, with emphasis on the flag register. It then describes the multiplexed address and data pins. A self-scoring quiz at the end of the program tests viewer retention.

Time: 29 minutes

Stock No:

90310RA	1/2" VHS (SP)	NTSC
90310RB	1/2" BETA I	NTSC
90310RD	3/4" UMACATIC	NTSC
90310RC	1/2" VHS (SP)	PAL
90301RE	1/2" BETA	PAL
90310RF	3/4" UMACATIC	PAL

Stack Pointer Lesson 4

This videocassette continues the description of the internal registers of the Intel 8085 Microprocessor. The stack pointer is programmed to keep track of a storage area in read/write memory where the contents of these internal registers may be stored. A self-scoring quiz completes this program.

Time: 18 minutes

Stock No:

90311RA	1/2" VHS (SP)	NTSC
90311RB	1/2" BETA I	NTSC
90311RD	3/4" UMACATIC	NTSC
90311RC	1/2" VHS (SP)	PAL
90311RE	1/2" BETA	PAL
90311RF	3/4" UMACATIC	PAL

Timing Cycles Lesson 5

This videocassette describes the 8085 Microprocessor timing cycles. The "T" or time cycles, "M" or machine cycles, and instructions are correlated so that the viewer has a thorough understanding of this complex subject. A self-scoring quiz completes the program.

Time: 18 minutes

Stock No:

90312RA	1/2" VHS (SP)	NTSC
90312RB	1/2" BETA I	NTSC
90312RD	3/4" UMACATIC	NTSC
90312RC	1/2" VHS (SP)	PAL
90312RE	1/2" BETA	PAL
90312RF	3/4" UMACATIC	PAL

Status Signals Lesson 6

This videocassette describes five status and strobe signals appearing at the pins of the Intel 8085 Microprocessor. These signals can be used to trouble-shoot a microprocessor system. A self-scoring quiz allows viewer interaction with the program.

Time: 23 minutes

Stock No:

90313RA	1/2" VHS (SP)	NTSC
90313RB	1/2" BETA I	NTSC
90313RD	3/4" UMACATIC	NTSC
90313RC	1/2" VHS (SP)	PAL
90313RE	1/2" BETA	PAL
90313RF	3/4" UMACATIC	PAL

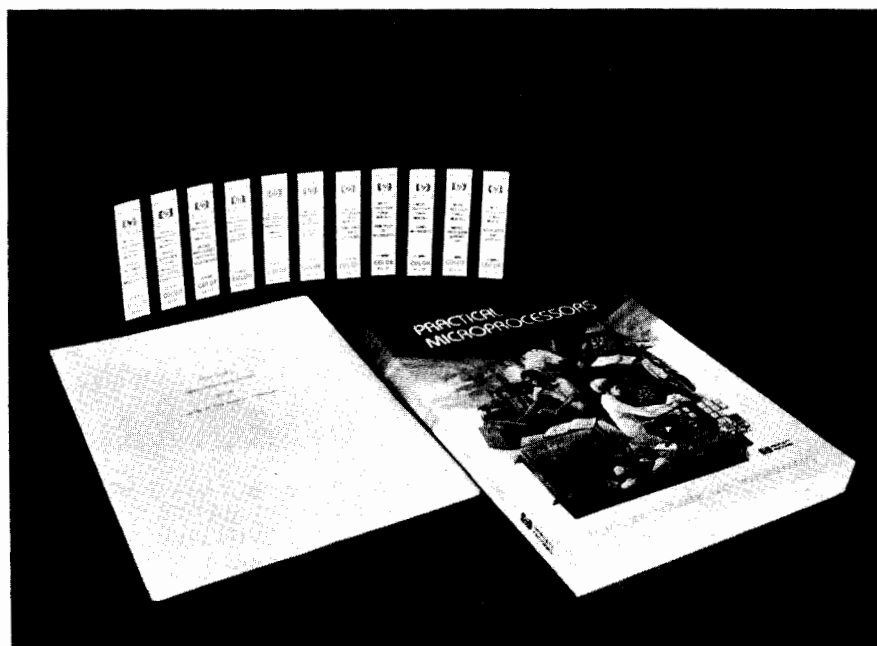

DMA and Handshaking Lesson 7

This videocassette describes how modern computer systems may input and output data using a technique called Direct Memory Access or DMA. In some systems handshaking is used to allow the microprocessor and a peripheral device to communicate during the DMA process. A self-scoring quiz allows a check of the viewer's retention.

Time: 22 minutes

Stock No:

90314RA	1/2" VHS (SP)	NTSC
90314RB	1/2" BETA I	NTSC
90314RD	3/4" UMACATIC	NTSC
90314RC	1/2" VHS (SP)	PAL
90314RE	1/2" BETA	PAL
90314RF	3/4" UMACATIC	PAL

Principles of Interrupts Lesson 8

Microprocessors can be much more efficient when interrupts are used correctly. This program discusses the hardware interrupt system designed into the Intel 8085 Microprocessor. A self-scoring quiz completes the lesson.

Time: 21 minutes

Stock No:

90315RA	1/2" VHS (SP)	NTSC
90315RB	1/2" BETA I	NTSC
90315RD	3/4" UMACATIC	NTSC
90315RC	1/2" VHS (SP)	PAL
90315RE	1/2" BETA	PAL
90315RF	3/4" UMACATIC	PAL

Using Interrupts Lesson 9

This program continues the description of the hardware interrupt system of the Intel

8085 Microprocessor and compares it to the software interrupt commands. A method of extending the external interrupts to as many as 64 is revealed. The self-scoring quiz completes the lesson.

Time: 25 minutes

Stock No:

90316RA	1/2" VHS (SP)	NTSC
90316RB	1/2" BETA I	NTSC
90316RD	3/4" UMACATIC	NTSC
90316RC	1/2" VHS (SP)	PAL
90316RE	1/2" BETA	PAL
90316RF	3/4" UMACATIC	PAL

Microprocessor Support Chips Lesson 10

Microprocessors need other circuits to function as a computer. These circuits: ROMs, RAMs, Decoders, and Ports are discussed in this program. How these devices are selected with the address bus is clearly explained. A quiz verifies the viewer's understanding of this important material.

Time: 22 minutes

Stock No:

90317RA	1/2" VHS (SP)	NTSC
90317RB	1/2" BETA I	NTSC
90317RD	3/4" UMACATIC	NTSC
90317RC	1/2" VHS (SP)	PAL
90317RE	1/2" BETA	PAL
90317RF	3/4" UMACATIC	PAL

Keyboards and Displays Lesson 11

Communicating with a microcomputer system usually is done with a keyboard and display system. How these systems are implemented using software and hardware is approached in this program. Some hardware failures are shown along with their usual re-



pair methods. The quiz completes this program.

Time: 16 minutes

Stock No:

90318RA	½" VHS (SP)	NTSC
90318RB	½" BETA I	NTSC
90318RD	¾" UMATIC	NTSC
90318RC	½" VHS (SP)	PAL
90318RE	½" BETA	PAL
90318RF	¾" UMATIC	PAL

Stock

No:

Books

05036-	Practical Microprocessors
90003	Textbook/Lab Workbook Understanding Microprocessors
90301RG	Study Guide

Oscilloscopes

How to Use an Oscilloscope Series

The oscilloscope is one of the most versatile and widely used electronic test instruments. However, for best results it must be used properly. The purpose of this 3 videocassette series is to train electronic technicians in the basic techniques of waveform measurement using an oscilloscope. The HP1740A general purpose scope and the HP1741A storage scope are used in this series. However, the information presented will also help you operate other scopes.

Tapes 1-3, time: 1 hour, 16 minutes

Stock No:

90741A	½" VHS (SP)	NTSC
90741B	½" BETA I	NTSC
90741D	¾" UMATIC	NTSC
90741C	½" VHS (SP)	PAL
90741E	½" BETA	PAL
90741F	¾" UMATIC	PAL

What's a dB?

The decibel is one of the most widely used and misused terms in electronics. Therefore, its meaning must be understood if dB measurements are to be useful. These programs explain the term and give examples to show how it is used.

Part 1—Power

Deals with power: power ratio to dB, dB to power ratio, and dBm.

Time: 21 minutes

Stock No:

90838A	½" VHS (SP)	NTSC
90838B	½" BETA I	NTSC
90838D	¾" UMATIC	NTSC
90838C	½" VHS (SP)	PAL
90838E	½" BETA	PAL
90838F	¾" UMATIC	PAL

Part 2—Voltage

Deals with voltage: voltage ratio to dB, and dB to voltage ratio.

Time: 15 minutes

Stock No:

90839A	½" VHS (SP)	NTSC
90839B	½" BETA I	NTSC

90839D	¾" UMATIC	NTSC
--------	-----------	------

90839C	½" VHS (SP)	PAL
--------	-------------	-----

90839E	½" BETA	PAL
--------	---------	-----

90839F	¾" UMATIC	PAL
--------	-----------	-----

How to Solder

A poor solder connection can cause electronic equipment to fail. That is why proper soldering is so important. This program will help train new hires in manufacturing and servicing—including those who believe they already know how to solder and unsolder properly.

Part 1 (16 minutes) Covers

What is soldering?	Flux
Wetting	Soldering irons
Solder	Timing

Part 2 (19 minutes) Shows

How to clean parts to be soldered
The four basic soldering steps
How to recognize a good solder connection
How to detect a poor solder connection
How to unsolder, using the vacuum bulb, the solder-sucker, and the desoldering wick.
The program ends with a summary and a self-scoring quiz.

Time: 35 minutes

Stock No:

90751A	½" VHS (SP)	NTSC
--------	-------------	------

90751B	½" BETA I	NTSC
--------	-----------	------

90751D	¾" UMATIC	NTSC
--------	-----------	------

90751C	½" VHS (SP)	PAL
--------	-------------	-----

90751E	½" BETA	PAL
--------	---------	-----

90751F	¾" UMATIC	PAL
--------	-----------	-----

Reliability

Printed Circuit Board Reliability

The purpose of this videocassette is to improve quality and productivity in production. It contains information concerning the reliability of printed circuit boards. 35 MM slides are used to illustrate corrosion, contact, soldering and cleaning problems associated with P.C. boards.

The primary audience is composed of production people, engineers, supervisors, assembly, test and P.C. board production people. It also can be helpful to design engineers and materials engineers.

Time: 36 minutes

Stock No:

90660RA	½" VHS (SP)	NTSC
---------	-------------	------

90660RB	½" BETA I	NTSC
---------	-----------	------

90660RD	¾" UMATIC	NTSC
---------	-----------	------

90660RC	½" VHS (SP)	PAL
---------	-------------	-----

90660RE	½" BETA	PAL
---------	---------	-----

90660RF	¾" UMATIC	PAL
---------	-----------	-----

P.C. Contact Reliability

This videocassette discusses contact reliability problems of the Edge Card Connector System. 35 MM slides are used to illustrate corrosion, contaminants, and cleaning methods.

Time: 25 minutes

Stock No:

90661RA	½" VHS (SP)	NTSC
---------	-------------	------

90661RB	½" BETA I	NTSC
---------	-----------	------

90661RD	¾" UMATIC	NTSC
---------	-----------	------

90661RC	½" VHS (SP)	PAL
---------	-------------	-----

90661RE	½" BETA	PAL
---------	---------	-----

90661RF	¾" UMATIC	PAL
---------	-----------	-----

Analysis of Multi-Layer Ceramic Capacitors

This videocassette discusses multi-layer ceramic capacitor construction, types of defects, and failure analysis using cross-sectioning techniques.

Time: 27 minutes

Stock No:

90662RA	½" VHS (SP)	NTSC
---------	-------------	------

90662RB	½" BETA I	NTSC
---------	-----------	------

90662RD	¾" UMATIC	NTSC
---------	-----------	------

90662RC	½" VHS (SP)	PAL
---------	-------------	-----

90662RE	½" BETA	PAL
---------	---------	-----

90662RF	¾" UMATIC	PAL
---------	-----------	-----

Static Zap Makes Scrap

The purpose of this cassette is to raise awareness of static damage hazards to electronic components and to provide training for all employees who handle electronic equipment; also, to demonstrate correct procedures.

The topic of this program is static electricity, and the prevention of static "zaps" (damage) which can cause failures in electronic equipment. Static-safe work stations and protective packaging are described, and their use is demonstrated. This program is intended to be a training aid for personnel in electronic manufacturing, test and service facilities.

Time: 30 minutes

Stock No:

90383RA	½" VHS (SP)	NTSC
---------	-------------	------

90383RB	½" BETA I	NTSC
---------	-----------	------

90383RD	¾" UMATIC	NTSC
---------	-----------	------

90383RC	½" VHS (SP)	PAL
---------	-------------	-----

90383RE	½" BETA	PAL
---------	---------	-----

90383RF	¾" UMATIC	PAL
---------	-----------	-----

Ordering Information

To order video programs, books, the HP 5035T Logic Lab or the 5036A Microprocessor Lab, please contact your local Hewlett-Packard sales office. Addresses are listed on pages 681-688.

Local taxes, shipping and handling will be added to all orders.

Videocassette formats in the NTSC standard are identified by an alpha suffix: "A" is for VHS(SP), "B" is for BETA I, and "D" is for U-matic. In the PAL standard "C" is for VHS(SP), "E" is for BETA and "F" is for U-matic.

To Get a Videotape Catalog

The 1984 edition of the HP Videotape Catalog, *A Better Way to Learn* (5952-0190) can be obtained from your local HP sales office or by writing to Inquiries Manager, Hewlett-Packard Company, 1820 Embarcadero Road, Palo Alto, CA 94303.

CABLES & ADAPTERS

Cables

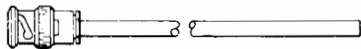

10501A: 112 cm (44 in)

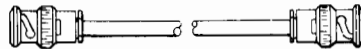

10502A L=23 cm (9 in)
10503A L=122 cm (48 in)

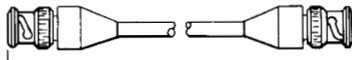

11170A: 30 cm (12 in)
11170B: 61 cm (24 in)
11170C: 122 cm (48 in)

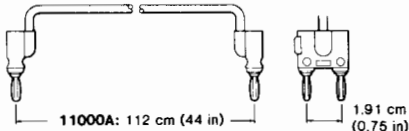

11000A: 112 cm (44 in) 1.91 cm (0.75 in)

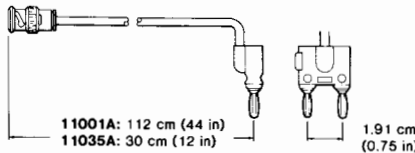

11001A: 112 cm (44 in)
11035A: 30 cm (12 in) 1.91 cm (0.75 in)

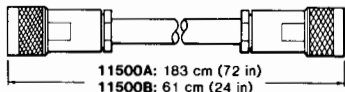

11500A: 183 cm (72 in)
11500B: 61 cm (24 in)

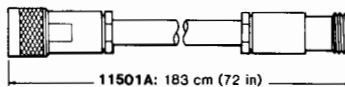

11501A: 183 cm (72 in)

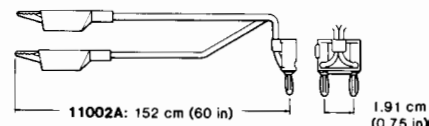

11002A: 152 cm (60 in) 1.91 cm (0.75 in)

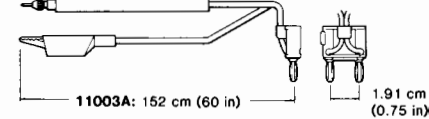

11003A: 152 cm (60 in) 1.91 cm (0.75 in)

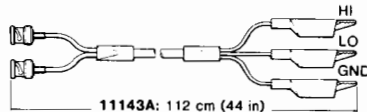

11143A: 112 cm (44 in)

Cable Assemblies

10501A: 112 cm 50Ω coax with one UG-88C/U BNC (m) connector

10502A: 23 cm 50Ω coax with UG-88C/U BNC (m) connectors

10503A: like 10503A, but 122 cm

11170A: 30 cm 50Ω coax with two BNC (m) connectors

11170B: like 11170A, but 61 cm
11170C: like 11170A, but 122 cm

11000A: 112 cm 50Ω coax with dual banana plugs

11001A: 112 cm 50Ω coax, UG-88C/U BNC (m) to dual banana plug

11035A: like 11001A, but 30 cm

11500A: 183 cm 50Ω coax with UG-21D/U Type N (m) connectors

11500B: like 11500A, but 61 cm

11501A: 183 cm 50Ω coax with UG-21D/U (m) and UG-23D (f) type N connectors

11002A Test Leads: 152 cm, alligator clips to dual banana plug

11003A Test Leads: 152 cm, probe and alligator clip to dual banana plug

11143A: 112 cm, dual BNC (m) to alligator clips

Coaxial Connector & Adapter Performance

These performance curves will help you in choosing and applying HP cables, connectors and adapters. SWR curves show design specifications for mated pairs of connectors of the type indicated. You can expect typical performance in that range.

For cross-series adapters, use the curve with the highest SWR in each case. For applications of Tee-adapters such as 1250-0559, 1250-0846 and 1250-0781, be sure to consider the extra shunt capacitance of the Tee.

Of course when HP mounts various connectors onto RF and microwave products, the product specification predominates and SWR is often far superior than that shown in these utility curves. For example, the HP "precision" Type-N adapters shown on the adjacent page are for high accuracy use dc-1.3 GHz where SWR < 1.03.

For more information on history and performance of various coax connectors, see pages 90-91 in HP's 1984 *Coaxial & Waveguide Measurement Accessories Catalog*. (Lit # 5952-8262).

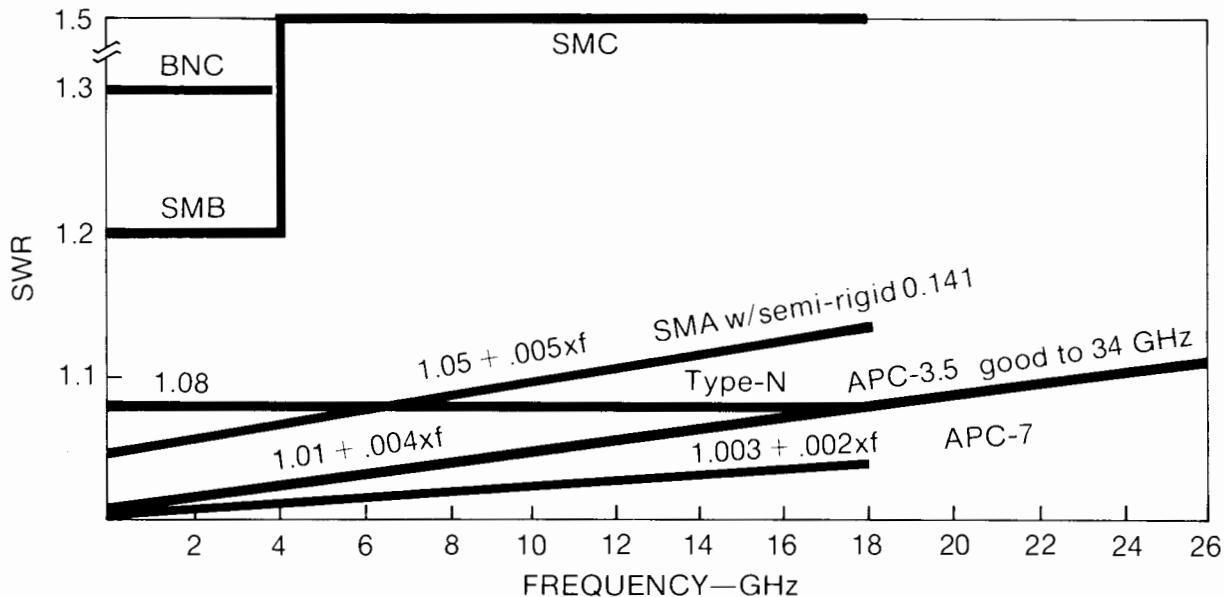

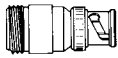

1250-0077
1250-1534
1250-1477

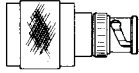

1250-0082
1250-1533
1250-1473

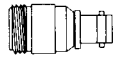

1250-1474
1250-1536



1250-0780
1250-1535
1250-1476

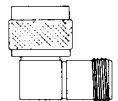

1250-0176

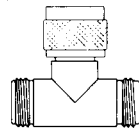

1250-0559

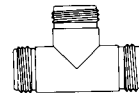

1250-0846

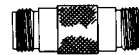

1250-0777
1250-1529
1250-1472

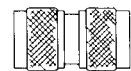

1250-0778
1250-1528
1250-1475

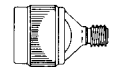

1250-1250



1250-1158



1250-1159

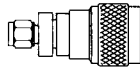

1250-1743

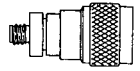

1250-1744

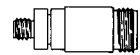

1250-1745

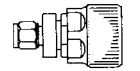

1250-1746

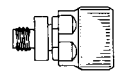

1250-1747



1250-1748



1250-1749



1250-1750



1250-0831

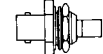

1250-1236



1250-0832

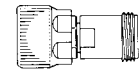

11524A

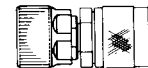

11525A

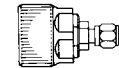

11533A

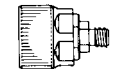

11534A



1250-0076
1250-1286

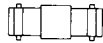

1250-0080
1250-1287



1250-0216
1250-1288

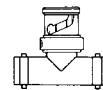

1250-0781

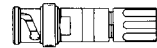

1250-1263

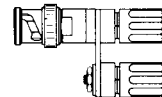

1250-1264

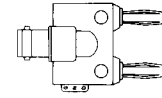

1251-2277

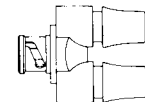

10110B

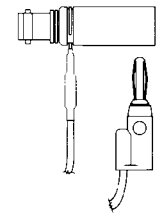

10111A

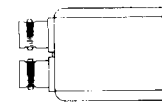

10113A

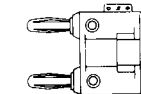

1251-2816

Adapters Type N, Standard 50 Ω

Part Number

1250-0077 N(f) to BNC(m)
1250-0082 N(m) to BNC(m)
1250-0176 N(m) to N(f) right angle (use below 12 GHz)
1250-0559 N tee, (m)(f)(f)
1250-0777 N(f) to N(f)
1250-0778 N(m) to N(m)
1250-0780 N(m) to BNC(f)
1250-0846 N tee (f)(f)(f)
1250-1250 N(m) to SMA(f)

Adapters Type N, Precision 50 Ω^[1]

1250-1472 N(f) to N(f)
1250-1473 N(m) to BNC(m)
1250-1474 N(f) to BNC(f)
1250-1475 N(m) to N(m)
1250-1476 N(m) to BNC(f)
1250-1477 N(f) to BNC(m)

Adapters Type N, Standard 75 Ω^[2]

1250-1528 N(m) to N(m)
1250-1529 N(f) to N(f)
1250-1533 N(m) to BNC(m)
1250-1534 N(f) to BNC(m)
1250-1535 N(m) to BNC(f)
1250-1536 N(f) to BNC(f)

Adapters APC-3.5

1250-1743 APC-3.5(m) to N(m)
1250-1744 APC-3.5(f) to N(m)
1250-1745 APC-3.5(f) to N(f)
1250-1746 APC-3.5(m) to APC-7
1250-1747 APC-3.5(f) to APC-7
1250-1748 APC-3.5(m) to APC-3.5(m)
1250-1749 APC-3.5(f) to APC-3.5(f)
1250-1750 APC-3.5(m) to N(f)

Adapters SMA

1250-1158 SMA(f) to SMA(f)
1250-1159 SMA(m) to SMA(m)

Adapters SMB, SMC^[4]

1250-0831 SMC(m) to BNC(m)
1250-0832 SMC(f) to BNC(f)
1250-1236 SMB(f) to BNC(f)

Adapters APC-7[®]

11524A APC-7 to N(f)
11525A APC-7 to N(m)
11533A APC-7 to SMA (m)
11534A APC-7 to SMA (f)

Adapter Banana Plug

1251-2816 Dual Banana plug

Adapters BNC, Standard 50 Ω

1250-0076 Right angle BNC(UG-306/D)
1250-0080 BNC(f) to BNC(f) (UG-914/U)
1250-0216 BNC(m) to BNC(m)
1250-0781 BNC tee(m)(f)(f)
1250-1263 BNC(m) to single banana plug
1250-1264 BNC(m) to dual banana plug
1251-2277 BNC(f) to dual banana plug
10110B BNC(m) to dual banana plug
10111A BNC(f) to shielded banana plug
10113A Dual BNC(f) to triple banana plug

Adapters BNC, Standard 75 Ω^[3]

1250-1286 Right Angle BNC
1250-1287 BNC(f) to BNC(f)
1250-1288 BNC(m) to BNC(m)

[1] "Precision": typically ≥ 36 dB return Loss to 1.3 GHz.

[2] Type N outer conductor; center pin sized for 75 Ω characteristic.

[3] BNC outer conductor; center pin sized for 75 Ω characteristic.

[4] SMB & SMC are used often inside HP instruments for inter-module connections.

* A registered trademark of the Bunker Ramo Corporation

CABINET ACCESSORIES

System II—Lock Link Kits, Rack Mount Slide Kits

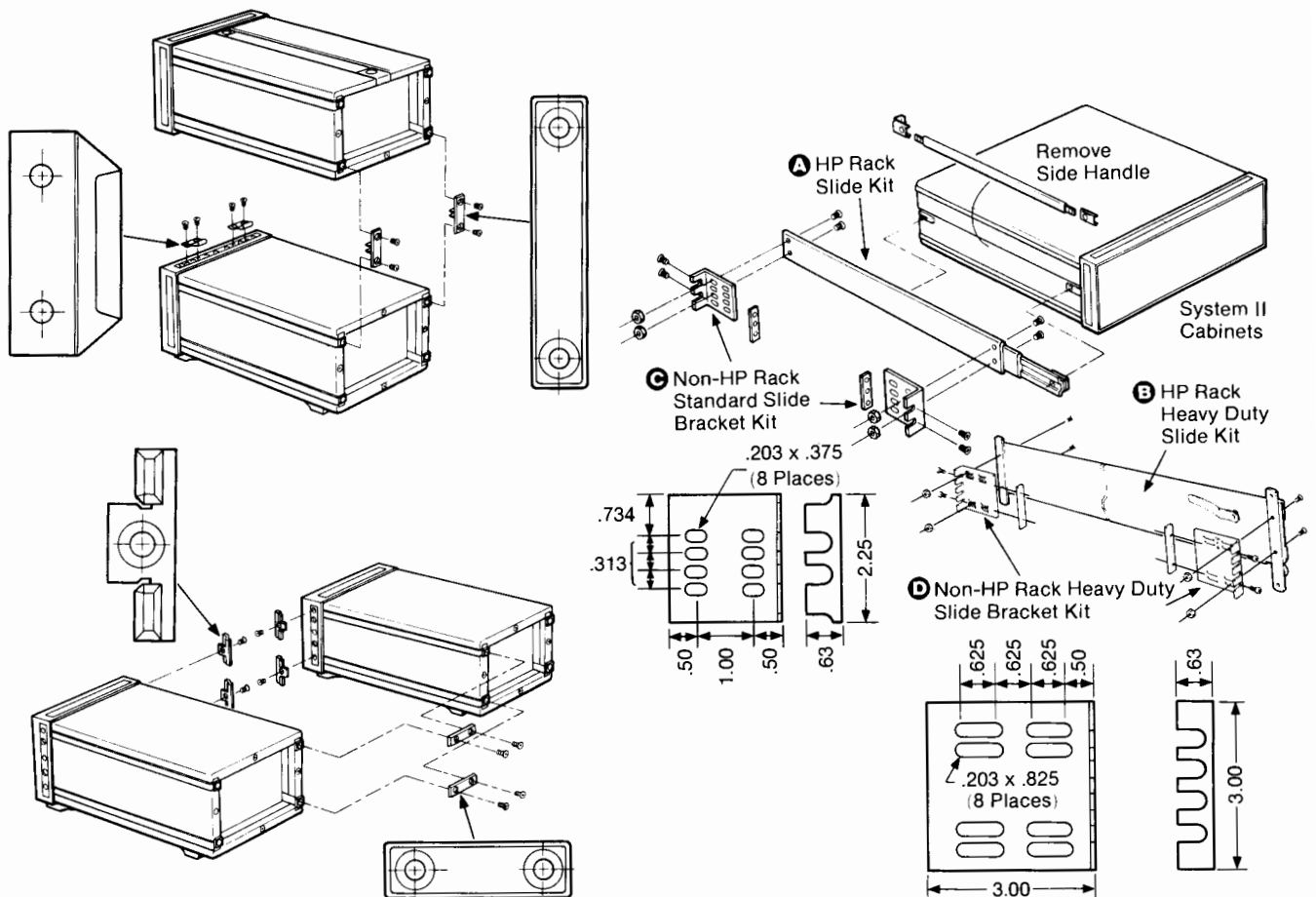

Lock Link Kits 5061-0094

All sub-module cabinets of equal depths can be linked together over-under or side-by-side with hardware in the lock link kit. Cabinet frames are already pre-threaded to allow quick assembly. For side-by-side connections the kit contains 12 front hooks and six rear links, enough for 3 side-by-side joints. For vertical connections, the kit also contains four front hooks and four rear links enough for two over-under joints. Kit includes screws. Locking cabinets together horizontally in a configuration wider than 1 MW is not recommended.

If the over-under linked combination is to include rear standoff feet (5061-2009), then the over-under locking feet kit 5061-0099 (next page) should be used for over-under connection.

5061-0094 Lock Link Kit is not recommended for full module over-under combinations. Use Kit 5061-0099 Locking Feet Kit (next page) to handle those larger weights.

Slide Kits and Rack Brackets

Rack slides are available for full-width System II cabinets to permit easy access to internal spaces. Each kit consists of two slides which mount directly to System II cabinet side handle recess spaces (after removing side handles). The slides also mount directly to vertical support rails in HP-racks. 1494-0018 mounts 14D and 17D depth System II cabinets. 1494-0017; 20D and 23D.

Standard weight slides carry 38.6 kg (85 lbs) max. load. Tilting versions are available in standard duty only. (1494-0025 and 1494-0026.)

For non-HP-racks, end bracket kits are available for both standard and heavy duty slide kits. Slotted hole arrays in the brackets provide for front-to-back rack rail spacing of 24, 26, and 28-inch nominal centers. They also allow choice of two vertical positions. Each kit of four brackets includes screws and four bar nuts. These general purpose mounting brackets fit most common non-HP-racks such as GE, Honeywell, etc.

Part No.	Name
5061-0094	Lock Link Kit
1494-0018	A Non-Tilting, Std. Slide Kit, Fits 14D & 17D Cabinets
1494-0017	A Non-Tilting, Std. Slide Kit, Fits 20D & 23D Cabinets
1494-0025	Tilting, Std. Slide Kit, Fits 14D & 17D Cabinets
1494-0026	Tilting, Std. Slide Kit, Fits 20D & 23D Cabinets
1494-0016	B Non-Tilting, Heavy Duty Slide Kits (20D & 23D Cabinets Only)
1494-0023	C (4) End Brackets for Non-HP Racks, Std. Slides
1494-0042	D (4) End Brackets for Non-HP Racks, Heavy Duty Slides

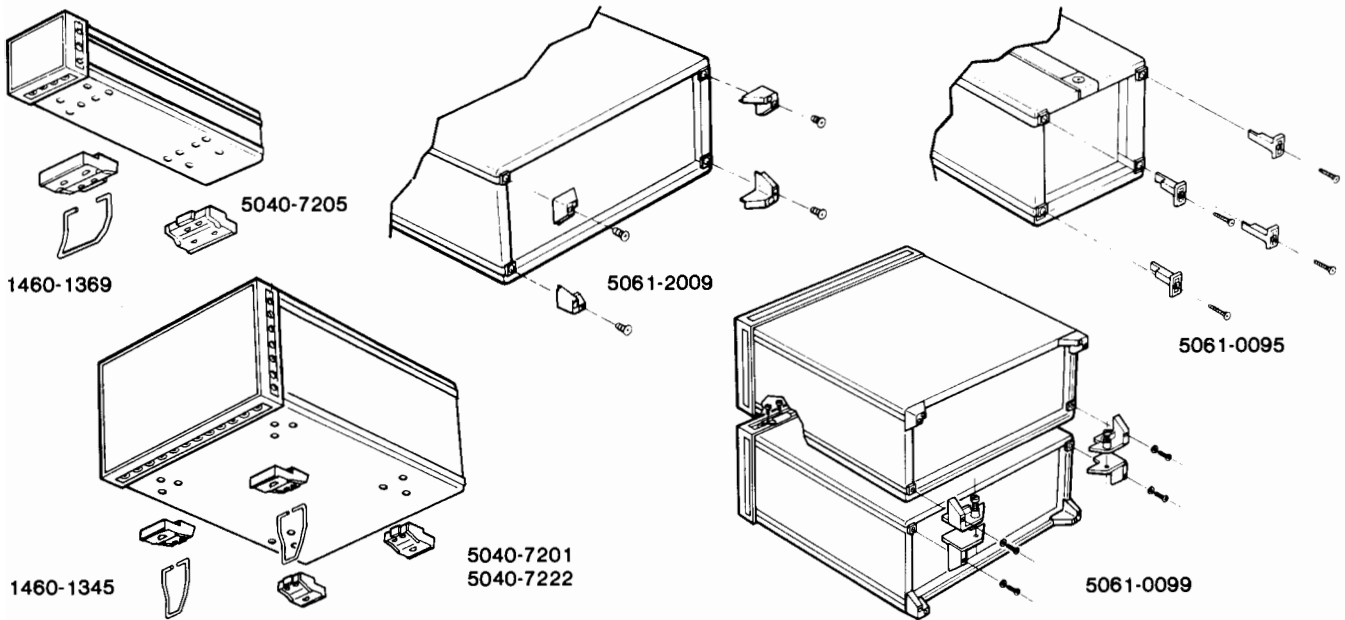

Bottom and Rear Cabinet Feet

Cabinet Rear Standoff Feet 5061-2009

Kit 5061-2009 provides four corner feet which give 25.4 mm (1-in) stand-off protection to the rear panel of instruments. It is used when instruments are to be operated or stored vertically on their rear panel. (Fits all but 1/4 MW by 3½H). Includes mounting screws.

Cord Wrap Feet Kit 5061-0095

Kit 5061-0095 contains four ribbed corner posts on which you can wrap power cords or signal cables for transport or storage. (Recommended for 1/4 MW and 1/2 MW cabinets weighing less than 11 kg, (24 lbs). Includes mounting screws.

Cabinet Bottom Feet and Tilt Stands

The standard foot 5040-7201 fits the bottom of full width and 1/2 MW cabinets. It fits front or rear and four are required. 5040-7222 foot is a non-skid version. Used in pairs it can prevent bench-top creeping. Tilt-stand 1460-1345 fits into the standard or non-skid foot and is used in pairs (front or rear) to tilt the instrument up or down for better viewing.

For 1/4 MW cabinets, foot 5040-7205 fits front or rear (two required). Tilt stand 1460-1369 fits the standard 1/4 MW foot and can be used front or rear depending on whether you want an upward or downward display.

Rear Panel Locking Foot Kit

When full module cabinets are to be linked vertically, and rear standoff feet are planned, use this kit. It consists of right and left foot linking pairs and 2 front hooks, enough for one over-under joint.

Also requires one 5061-2009 foot kit to supply the remaining 4-corner feet.

Part No.	Name
5061-2009	Rear Standoff Feet Kit (4 Feet)
5061-0095	Cord Wrap Feet Kit (4 Feet)
5040-7201	Standard Foot
5040-7222	Non-Skid Foot
1460-1345	Tilt Stand
5040-7205	1/4 MW Foot
1460-1369	1/4 MW Tilt Stand
5061-0099	1 MW Cabinet Lock-Foot Kit

CABINET ACCESSORIES

SYSTEM I—Rack Hardware and Accessories

System I Cabinet Design

System I Cabinets are still used on older HP instruments. System I can be identified by its front handles being integral with the side casting frame. These next two pages describe accessories for use with System I Cabinets and small modular instruments.

1051A

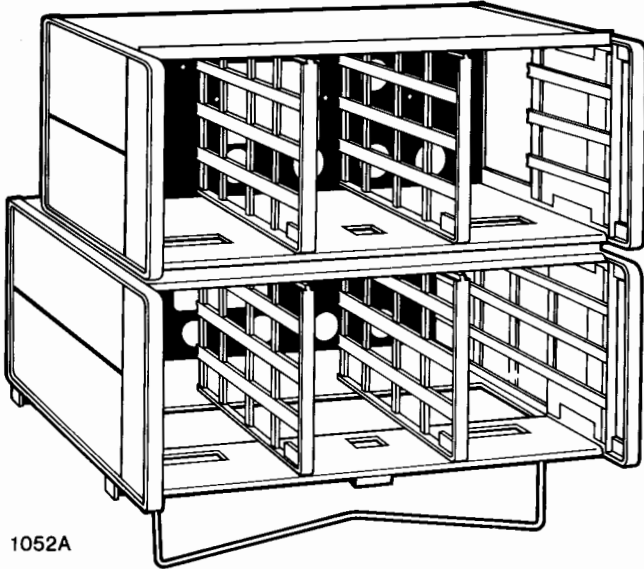

1052A

Combining Cases, 1051A, 1052A

Models 1051A and 1052A combining cases conveniently rack or bench mount combinations of small modular Hewlett-Packard SYSTEM-I instruments. Both cases accept $\frac{1}{4}$ or $\frac{1}{2}$ instrument modules, 130mm or 198 mm wide ($5\frac{1}{4}$ or $7\frac{25}{32}$ inches). The basic difference is that the 1052A is 130 mm ($5\frac{1}{8}$ in.) deeper, and will accept modules up to 416mm deep ($16\frac{3}{8}$ in.). The 1051A accepts instruments up to 286mm deep ($11\frac{1}{4}$ in.). Each case is furnished with two dividers.

Accessory drawer 5060-8756 supplies storage space $\frac{1}{2}$ width and 77 mm ($3\text{-}1/32$ ") high. Use a 5060-8758 filler panel above or below.

1051A, 1052A, 5060-8756 Specifications

Size

1051A: 178 H x 482.6 W x 337 mm D (7 " x 19 " x $13\frac{1}{4}$ ").

1052A: 178 H x 482.6 W x 467 mm D (7 " x 19 " x $18\frac{3}{8}$ ").

Weight

1051A: net, 4.5 kg (10 lb). Shipping, 6.7 kg (15 lb).

1052A: net, 5.4 kg (12 lb). Shipping, 8.1 kg (18 lb).

Opt 908: Rack Mount Kit

Opt 910: Extra Manual

5060-8756 Accessory Drawer

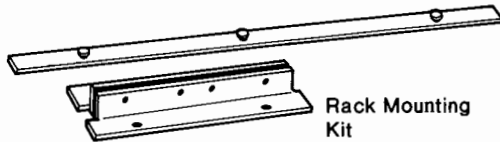

Rack Mounting Kit

Rack Mounting Kits, 5060-8739 to 5060-8744

With these kits all Hewlett-Packard products in full rack-width cabinets of the integral side frame-handle style (see 1051A, 1052A, Combining Cases above) can be easily prepared for rack mounting. Each kit contains two flanges, a filler strip, and mounting screws.

Rack Mounting Kit Ordering Information

Part Number	Nominal Cabinet Height	
	Millimetres	Inches
5060-8739	88.1	3½
5060-8740	132.6	5¼
5060-8741*	177	7
5060-8742	221.5	8¾
5060-8743	265.9	10½
5060-8744	310.4	12¼

* Also used to rack mount Combining Kits 1051A & 1052A shown above.

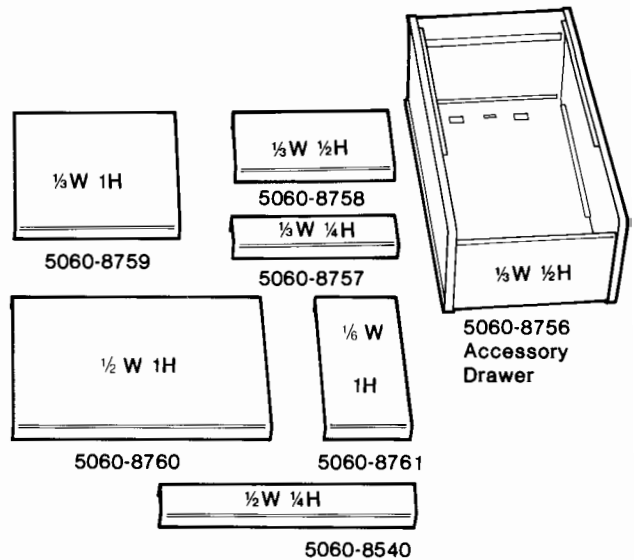

Filler Panels, 5060-8540, 5060-8757 to 5060-8761

Filler panels can be used to close off any leftover space after instruments are mounted in combining cases (left) or adapter frames (below). Panels are made in a variety of widths and heights.

Specifications, Filler Panels

Part No.	Module Case Height x Width	Dimensions	
		Millimetres	Inches
5060-8540	$\frac{1}{4}$ x $\frac{1}{2}$	38 x 198	$1\frac{1}{2}$ x $7\frac{25}{32}$
5060-8757	$\frac{1}{4}$ x $\frac{1}{2}$	38 x 130	$1\frac{1}{2}$ x $5\frac{1}{8}$
5060-8758	$\frac{1}{2}$ x $\frac{1}{2}$	77 x 130	$3\frac{1}{2}$ x $5\frac{1}{8}$
5060-8759	full x $\frac{1}{2}$	155 x 130	$6\frac{3}{32}$ x $5\frac{1}{8}$
5060-8760	full x $\frac{1}{2}$	155 x 198	$6\frac{3}{32}$ x $7\frac{25}{32}$
5060-8761	full x $\frac{1}{6}$	155 x 63	$6\frac{3}{32}$ x $2\frac{3}{64}$

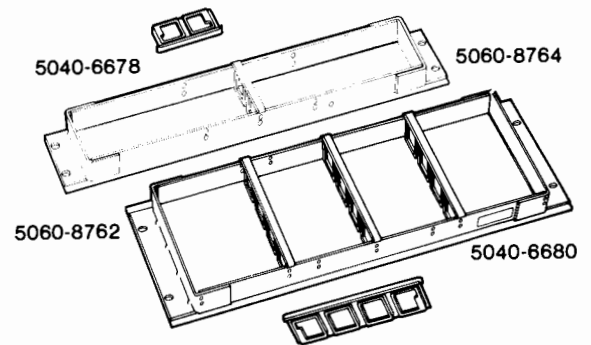

Rack Adapter Frames, 5060-8762, 5060-8764

These Frames can be used to hold combinations of $\frac{1}{4}$ and $\frac{1}{2}$ module-width HP instruments. Each frame is furnished with mounting hardware and three dividers. Two models are available for different instrument heights. Adapter frames are for permanent or semi-permanent rack mounting. Where quick removal and reinstallation of instruments is desirable, the 1015A and 10152A should be used.

5060-8762 is 178 mm (7-inch) high and accepts instruments heights of $\frac{1}{4}$ H, $\frac{1}{2}$ H, and 1H. 5060-8764 is 89 mm ($3\frac{1}{2}$ -inch) high and accepts instruments of $\frac{1}{4}$ H and $\frac{1}{2}$ H.

Part No.	Name
5060-8762	Rack Adapter 178mm (7-in)
5060-8764	Rack Adapter 89mm (3½-in)
5040-6678	Extra Vertical Dividers for 5060-8764
5040-6680	Extra Vertical Dividers for 5060-8762

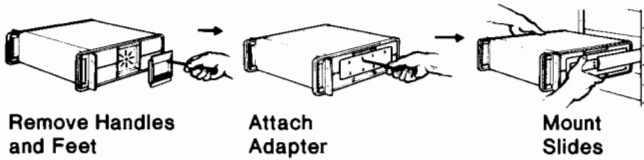

Remove Handles and Feet

Attach Adapter

Mount Slides

Rack Mount Slide Kits and Cabinet Adapters

By removing the side handle of Full Width System I Cabinets, rack mount slides can be attached for easy access to internal space. Both tilting and non-tilt are available, while max. load factor is 31.7 kg (70 lbs). The cabinet adapter plate attaches to the handle recess and thence to the slide. Slide kits include four angle brackets which mount to rack rails with front-to-back nominal spacings of 24-inch, 26-inch and 28-inch.

Rack Mount Slide Kits, 1490-0713 to 1490-0720

Part Number ¹	Cabinet Depth	Extension Length
1490-0713*	All Sizes	482.6 (19) ²
1490-0714*	All Sizes	635.0 (25) ³
1490-0715#	279.4 (11)	482.6 (19) ²
1490-0716#	406.4 (16)	482.6 (19) ²
1490-0717#	279.4 (11)	533.4 (21) ³
1490-0718#	406.4 (16)	558.8 (22) ³
1490-0719#	482.6 (19)	635.0 (25) ³
1490-0720#	558.8 (22)	635.0 (25) ³

Notes: *Fixed type slide; #Tilt type slide
 1. Cabinet Adapters, below, must be added to slides
 2. Slide's stationary mounting depth: 406.4 (16)
 3. Slide's stationary mounting depth: 558.8 (22)

Cabinet Adapters

Part No.	Name
1490-0722	Adapter Plate for 88.9mm H(3½-in.) Cabinets
1490-0721	Adapter Plate for 133mm H(5¼-in.) and higher Cabinets

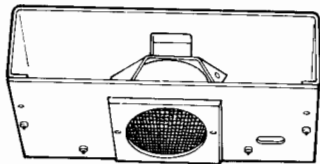

Cooling Kits, 5060-0789 and 5060-0796

These cooling kits are designed to be easily installed in the rear of the 1052A Combining Case (only).

- 5060-0789: 115 V, 50 to 60 Hz
- 5060-0796: 230 V, 50 to 60 Hz

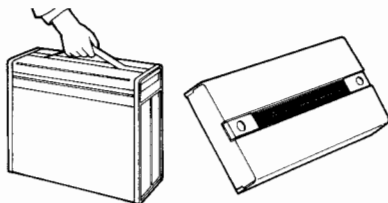

Control Panel Covers, 5060-8766 to 5060-8771

A series of control panel covers equipped with carrying handles are available for full rack width instruments. These covers protect instrument front panels and make rack mounted instruments tamper-proof.

One of these covers, the 5060-8768, fits both the 1051A and the 1052A Combining Case (page 662). Other covers are available to fit the six modular enclosures with front panel heights ranging from 88.1 to 310.4 mm (3½ to 12¼ in.). Cover locks securely to front handles.

- 5060-8766: 88.1 mm (3½ in.) EIA panel height
- 5060-8767: 132.6 mm (5¼ in.) EIA panel height
- 5060-8768: 177 mm (7 in.) EIA panel height
- 5060-8769: 221.5 mm (8¾ in.) EIA panel height
- 5060-8770: 265.9 mm (10½ in.) EIA panel height
- 5060-8771: 310.4 mm (12¼ in.) EIA panel height

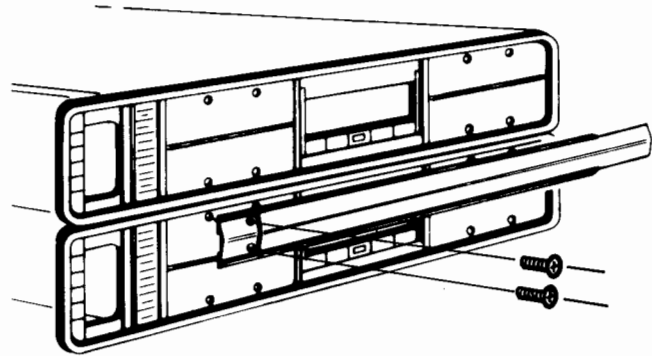

Joining Bracket Kits, 5060-8541 to 5060-8545

These kits join HP SYSTEM I instruments of the same width and length into easily handled single stacks. Each kit consists of two brackets, mounting hardware and trim. They are available to fit the three most common instrument depths:

- 5060-8541: 279 mm (11 in.) EIA panel depth
- 5060-8543: 406 mm (16 in.) EIA panel depth
- 5060-8545: 480 mm (19 in.) EIA panel depth

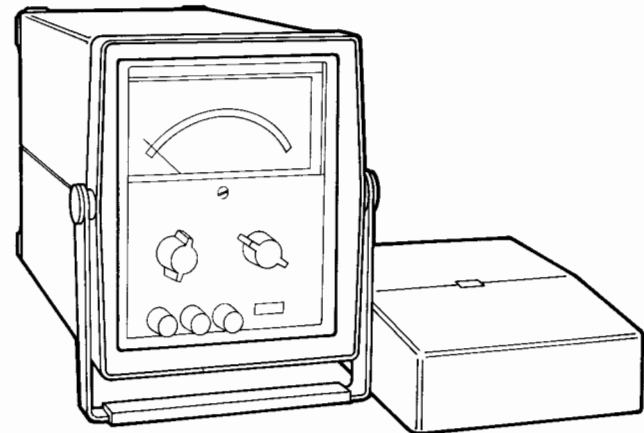

Module Instrument Cases, 11075A, 11076A

Rugged, high impact plastic instrument cases for HP system I ½ module instruments. Instruments can be operated, stored or carried in this splashproof case. Storage compartment for power cord in rear of case is accessible through a removable hatch. Front lid contains adequate storage space for cables, test leads, etc. The dual purpose tilt stand also serves as a carrying case handle. 11075A holds instruments 203 mm D (8 in.); 11076A carries modules up to 279 mm D (11 in.).

- 11075A: Module Instrument Case
- 11076A: Module Instrument Case



CABINET ACCESSORIES

Rugged Protection for Instruments

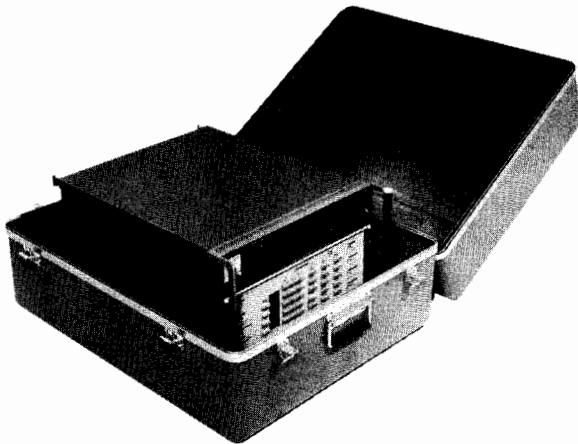

Typical System II Transit Case

Hewlett-Packard transit cases are rugged protective outer shells for use when instruments must be frequently transported or used away from laboratory conditions. HP cases protect your instruments from hostile environments, shock, vibration, moisture, and impact while providing a secure enclosure for shipping. The cases are molded from a structural composite which is 65% lighter than aluminum, yet which provides excellent strength and durability. Tests of the composite show tensile and compressive strength exceeding 33,000 PSI and flexural strength exceeding 45,000 PSI.

Typical Uses

Transit cases are a necessity whenever equipment is frequently transported from one operating location or test site to another, or is shipped for testing and calibration. Transit cases are particularly valuable for instruments used by service and repair personnel. For example, telephone companies frequently use transit cases for the instruments they use to repair line faults. Transit cases are also valuable when instruments must be transported over rough roads, or are used in dusty environments or outdoors.

HP Product Number to Transit Case Number Cross Reference in Part Number Sequence

Oscilloscopes		Voltmeters		Microwave Instruments (cont.)		Oscillators (cont.)	
1715A	9211-2459	3400A	9211-2667	8672A	9211-2661	204D	9211-1316
1725A	9211-2459	3455A	9211-2654	8683	9211-2649	209A	9211-1316
1740A	9211-2459	3456A	9211-2654	8684	9211-2649	654A	9211-1289
1741A	9211-2459	3466A	9211-2666	8970A	9211-2649		
1742A	9211-2459					Distortion Analyzers	
1743A	9211-2459	Source Analyzers		Component Measurement		334A	9211-1289
		334A	9211-1289	4145A	9211-2663	339A	9211-2643
		3325A	9211-2662	5345A	9211-2682		
Signal Generators		3582A	9211-2662			Function Generators	
3200B	9211-1734	3585A	9211-2663	Network Instruments		3325A	9211-2655
8640B	9211-0839			8505A	9211-2665	3330A	9211-1163
8654	9211-2800	Signal Analyzers		8620C	9211-1289	3336A	9211-2655
8654B	9211-1895	141T	9211-1294	Laser Instruments		3336B	9211-2655
8655A	9211-2799	5420B	9211-2661	5500C	9211-1586	3336C	9211-2655
8655	9211-2800	5423	9211-2661	5505A	9211-1289		
8656A	9211-2661	8555A	9211-2671	5510A	9211-1738	Spectrum Analyzers	
8660A	9211-2525	85650A	9211-2654			3582A	9211-2662
8662A	9211-2662	8565A	9211-1735	Communication Testing		3585A	9211-2663
		8566A	9211-1297	3702B	9211-1294	Wave Analyzers	
Recorders		8568A	9211-2664	3710A	9211-1293	3586A/B/C	9211-2650
3968A	9211-2557	Microwave Instruments		1645A	9211-1289		
		432A	9211-2667	3745A	9211-1297	Computing Products/Terminals	
Counters		435B	9211-1318	4955	9211-2662	262X series	9211-4677
5328A	9211-1292	436A	9211-2667	4945A	9211-2656	264X series	9211-4676
5342A	9211-2682	8403A	9211-1292	8405	9211-1293	82905B	9211-4684
5340A	9211-1292	8614A	9211-0839			85/86B	9211-4559
5343A	9211-2682	8616A	9211-0839	Oscillators		9134A	9211-0839
5345A	9211-1296	8671A	9211-2661	204C	9211-1316	9826A	9211-2662

Product Detail

HP transit cases are pressure molded of an extremely strong and light fiberglass and resin laminate which provides an excellent strength to weight ratio. All cases seal tightly with O-ring gaskets and clamping latches. They are rainproof under the test conditions of MIL-STD-108. Carrying handles are conveniently placed, and fold flat when not in use.

Transit cases are typically provided with foam cushions that are designed to cradle the instrument securely. Maximum protection is provided against damage from handling, dropping, or crushing. The cushion inserts are typically molded polyurethane, or are fabricated from slabs of polyurethane or polyethylene flexible foams. Each case/cushion unit is designed as its own shock and vibration damping system.

Hewlett-Packard's standard transit cases provide effective protection from all but the most abusive treatment. If you prefer more protection, Hewlett-Packard can supply your case in a heavy duty version. This version is tough enough to withstand the most severe treatment and conditions. To ensure maximum protection for your instrument, transit cases are also available in versions that meet the specified requirements of MIL-STD-108, MIL-T-21200, MIL-T-28800, MIL-T4734, and MIL-C-4150.

Removable swivel casters are available as an option on certain HP transit cases. (Approximately 4½ inches of lid space is needed to install removable casters.) These cases are identified with a † on the case selection tables.

How to Select the Proper Transit Case

Transit cases are available for almost all HP instruments. If you are ordering a case for one of HP's 60 most popular instruments, you can use the quick cross-reference table below. To order a case for any other instrument, please read the section titled "How to Measure," and use the tables for ordering System I and System II style cases.

Instrument Cabinet System Styles

Hewlett-Packard produces two styles of cabinet systems: System I and System II. The most visible difference is handle configuration; the handles on System I instruments are a part of the instrument side frame, and project at 90 degrees from the instrument face. The handles on System II modules also project at 90 degrees from the instrument face, but are not a part of the instrument frame, are easily removable, and are turned outward at the handle grip. Each of the cabinet styles requires a different cushion insert configuration. This difference makes it important to order your case from the correct selection table.

Transit Case Styles

Each transit case will be coded according to its style in the following tables. Valise (V), hinged with the handle opposite the hinge. Transit (T), a completely removable cover with a handle at each end. Valise Transit (VT), a hinged transit case with a handle opposite the hinge and a handle at each end. A † next to the case style designator indicates that removable casters are an option. Each case is designed and manufactured in the style which best suits the configuration of its instrument. If a style other than the standard is more appropriate for your application, a special case can be ordered.



Typical transit (T) style case

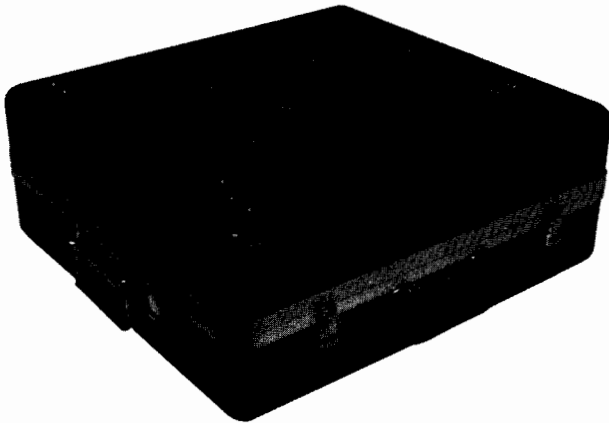

Typical valise (V) style case



Typical valise transit (VT) style case

Special or Custom Transit Cases

When HP began providing standardized cases, it was understood that there would be certain instruments that would not fit into the standard cases. For that reason, special or custom cases are available.

Proper fit is very important in protecting your instrument, and the dimensional measurements of your instrument are critical. It is recommended that when ordering a custom case, you provide your Hewlett-Packard sales office with: the instrument's exact height, width, and depth, the serial and model number, and any other pertinent information that may affect the design of the case or cushions. In designing your own case, you may wish to have additional space available for the protected storage of materials necessary for your instrument's on-site operation. Space can be provided for storing power/data cables, operating supplies, accessories, additional printed circuit boards, and documentation or manuals. All specifications and measurements should be on hand when discussing your needs with a representative from your local HP sales office.

Colors

HP transit cases are produced in "Hewlett-Packard Pearl Gray Cabinet," a standard color used in whole or in part on a majority of the instruments HP produces. Transit cases in any other color must be a special order at additional cost.

Accurate Measurements Assure Proper Fit

To assure proper fit, each instrument must be measured carefully. The three measurements necessary are:

WIDTH: The distance across the entire body of the instrument, not including rack mounting accessories. Instruments set up to be rack mounted require special cushion designs (custom transit cases).

DEPTH: The depth of the instrument from the front panel face to the rearmost projection at the back of the instrument. On a System II instrument add two inches if the instrument has handles.

HEIGHT: The actual instrument height from the base to the top of the cabinet.

The selection tables included American standard and metric measurements. The addition of any options, accessories, or standoff devices will affect the instrument's overall configuration, and must be taken into consideration when ordering a transit case.

CABINET ACCESSORIES

Rugged Protection for Instruments (cont.)

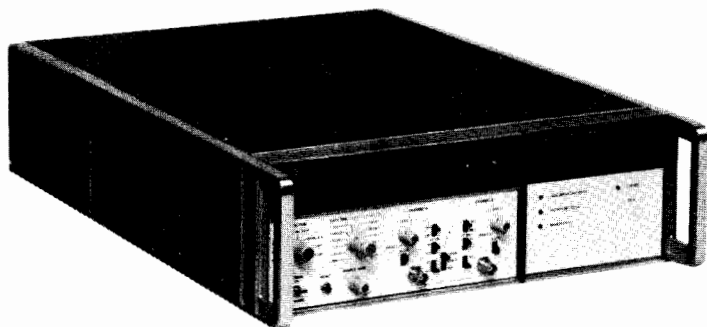

Typical full module System I style cabinet

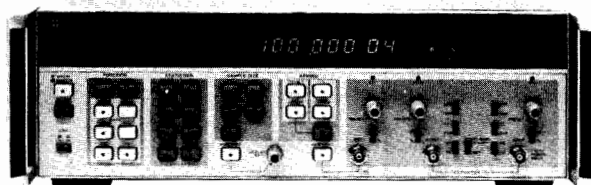

Typical full module System II style cabinet

System I Cabinet Style Transit Cases

Full Module Width Instruments				
Width = 16.75 in.				
Depth = 13.25 in.				
Inst. Height in mm	Case Height in mm	Style	HP Part Number	
3.50 88.1	20.50 520.7	VT†	9211-1288	
5.25 132.6	20.50 520.7	VT†	9211-1289	
7.00 177.0	20.50 520.7	VT†	9211-1290	
8.75 221.5	20.25 514.4	T	9211-1291	
3.25 88.1	22.88 584.2	VT†	9211-1292	
5.25 132.6	22.88 584.2	VT†	9211-0839	
7.00 177.0	22.88 584.2	VT†	9211-1293	
8.75 221.5	22.88 584.2	VT†	9211-1294	
10.5 265.9	22.88 584.2	T	9211-1295	
12.25 310.4	22.88 584.2	T	9211-1313	
5.25 132.6	25.50 647.7	VT†	9211-1296	
7.00 177.0	25.50 647.7	VT†	9211-1735	
12.25 310.4	29.75 755.7	T	9211-1297	
Two-thirds Module Width Instruments				
Width = 10.50 in.				
Depth = 11.00 in.				
6.50 165.1	16.50 419.1	V	9211-1895	
Half Module Width Instruments				
Width = 7.75 in.				
Depth = 8.0 in.				
6.50 165.1	16.88 428.6	V	9211-1315	
Depth = 11.0 in.				
6.50 165.1	16.88 428.6	V	9211-1315	
Depth = 16.0 in.				
6.50 165.1	21.63 520.7	V	9211-1734	
One-third Module Width Instruments				
Width = 5.125 in.				
Depth = 8.0 in.				
6.50 165.1	14.25 362.0	V	9211-1317	
Depth = 11.00 in.				
11.0 279.4	16.88 428.6	V	9211-1318	

System II Cabinet Style Transit Cases

Full Module Width Instruments				
Width = 16.75 in.				
Depth = 13.75 in.				
Inst. Height in mm	Case Height in mm	Style	HP Part Number	
3.50 88.1	8.75 222.3	VT	9211-2642	
5.25 132.6	10.5 266.7	VT	9211-2643	
7.00 177.0	12.25 311.2	VT	9211-2644	
8.75 221.5	14.00 355.6	VT	9211-2645	
10.5 265.9	15.75 400.1	T†	9211-2646	
12.25 310.4	17.25 444.5	T	9211-2647	
Depth = 16.75 in.				
Inst. Height in mm	Case Height in mm	Style	HP Part Number	
3.50 88.1	8.75 222.3	VT	9211-2648	
5.25 132.6	10.5 266.7	VT	9211-2649	
7.00 177.0	12.25 311.2	VT	9211-2650	
8.75 221.5	14.00 355.6	T†	9211-2651	
10.5 265.9	15.75 400.1	T†	9211-2652	
12.25 310.4	17.25 444.5	T†	9211-2653	
Depth = 19.75 in.				
Inst. Height in mm	Case Height in mm	Style	HP Part Number	
3.50 88.1	8.75 222.3	VT	9211-2654	
5.25 132.6	10.5 266.7	VT	9211-2655	
7.00 177.0	12.25 311.2	VT	9211-2656	
8.75 221.5	14.00 355.6	T†	9211-2657	
10.5 265.9	15.75 400.1	T†	9211-2658	
12.25 310.4	17.25 444.5	T†	9211-2659	
Depth = 22.75 in.				
Inst. Height in mm	Case Height in mm	Style	HP Part Number	
3.50 88.1	8.75 222.3	VT	9211-2660	
5.25 132.6	10.5 266.7	VT	9211-2661	
7.00 177.0	12.25 311.2	T†	9211-2662	
8.75 221.5	14.00 355.6	T†	9211-2663	
10.5 265.9	15.75 400.1	T†	9211-2664	
12.25 310.4	17.25 444.5	T†	9211-2665	

CABINET ACCESSORIES

Operating Cases

667



Typical System II half module instrument

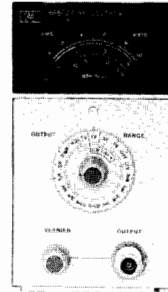

Typical System II quarter module instrument

Half Module Width Instruments					
Width = 8.375 in.					
Depth = 10.75 in.					
Inst. Height	Case Height		Style	HP Part	
in mm	in mm			Number	
3.50	88.1	7.50	190.0	V	9211-2666
5.25	132.6	9.25	235.0	V	9211-2667
7.00	177.0	11.0	279.4	V	9211-2668
8.75	221.5	12.75	323.9	V	9211-2669
10.5	265.9	14.5	368.3	V†	9211-2670
Depth = 13.25 in.					
Inst. Height	Case Height		Style	HP Part	
in mm	in mm			Number	
3.50	88.1	7.50	190.0	V	9211-2671
5.25	132.6	9.25	235.0	V	9211-2672
7.00	177.0	11.0	279.4	V	9211-2673
8.75	221.5	12.75	323.9	V	9211-2674
10.5	265.9	14.5	368.3	V	9211-2675
Depth = 16.75 in.					
Inst. Height	Case Height		Style	HP Part	
in mm	in mm			Number	
3.50	88.1	7.50	190.0	V	9211-2676
5.25	132.6	9.25	235.0	V	9211-2677
7.00	177.0	11.0	279.4	V	9211-2678
8.75	221.5	12.75	323.9	V	9211-2679
10.5	265.9	14.5	368.3	V	9211-2680
Depth = 19.75 in.					
Inst. Height	Case Height		Style	HP Part	
in mm	in mm			Number	
3.50	88.1	7.50	190.0	V	9211-2681
5.25	132.6	9.25	235.0	V	9211-2682
7.00	177.0	11.0	279.4	V	9211-2683
8.75	221.5	12.75	323.9	V	9211-2684
10.5	265.9	14.5	368.3	V	9211-2685

Quarter Module Width Instruments					
Width = 4.50 in.					
Depth = 10.75 in.					
Inst. Height	Case Height		Style	HP Part	
in mm	in mm			Number	
3.50	88.1	6.50	165.1	V	9211-2683
5.25	132.6	8.25	209.6	V	9211-2687
7.00	177.0	10	254.0	V	9211-2688
Depth = 13.25 in.					
Inst. Height	Case Height		Style	HP Part	
in mm	in mm			Number	
3.50	88.1	6.50	165.1	V	9211-2689
5.25	132.6	8.25	209.6	V	9211-2690
7.00	177.0	10	254.0	V	9211-2691
Depth = 16.25 in.					
Inst. Height	Case Height		Style	HP Part	
in mm	in mm			Number	
3.50	88.1	6.50	165.1	V	9211-2692
5.25	132.6	8.25	209.6	V	9211-2693
7.00	177.0	10	254.0	V	9211-2694

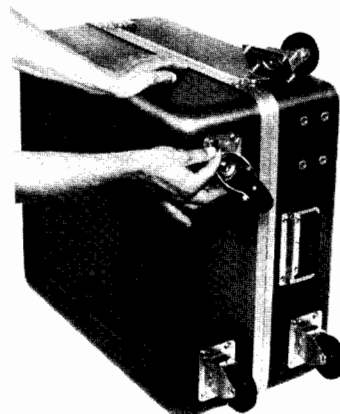

Field installed swivel caster kit. HP part number 1490-0913

CABINET ACCESSORIES

Operating Cases (cont.)

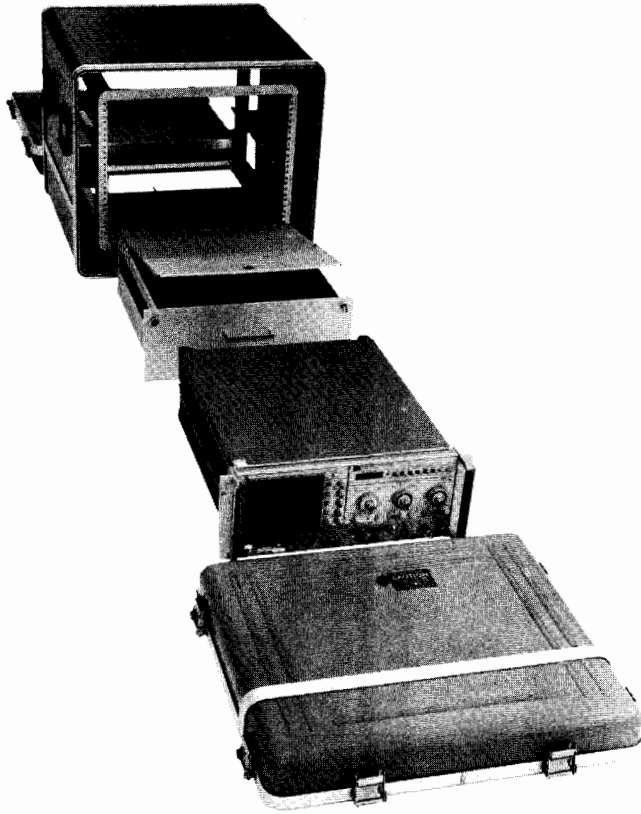

Exploded view of an Operating Case with an instrument and drawer ready for mounting.

Operating Cases

Hewlett-Packard operating cases are rugged protective enclosures, used when instruments are transported and used on-site. They are constructed of the same pressure molded fiberglass/resin laminate as Hewlett-Packard transit cases. Hewlett-Packard's standard hardware provides excellent protection from damage and the elements. Conveniently placed handles fold flat when not in use. Front and back covers seal with O-ring gaskets and clamping latches. All transit cases are rainproof under MIL-STD-108.

Interior Configuration

Operating cases are equipped with shock mounted aluminum frames that accept any standard 19-inch rack mounting instrument (EIA-RETMA standard), up to the height of the frames. Most full sized instruments and modular combinations of instruments can be rack mounted in one of our operating cases. The frame arrangement and the ability to remove the front and back covers allows the convenience of operation without removing the instrument. As a result, the instrument can be set up for operation with a minimum of delay. At the same time, environmental protection is afforded. Both Hewlett-Packard System I and System II cabinet styles can be mounted in operating cases (including System I module combining cases).

Rack mounting offers a number of conveniences. Total systems configured of individual instruments and accessories can be combined in one or more operating cases. Patch cable, HP-IB, and HP-IL connections can be left in place within the case, so that instruments are ready to be put into use with a minimum of delay.

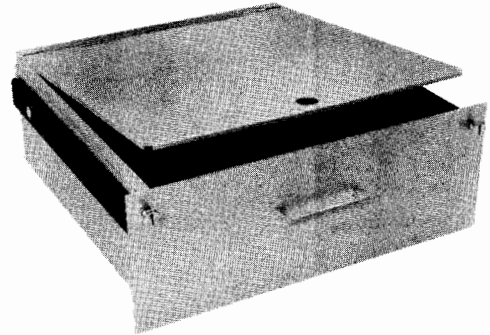

Sturdy drawers that accommodate various HP accessories and operating supplies are available in three sizes, and come with smooth operating ball bearing slides.

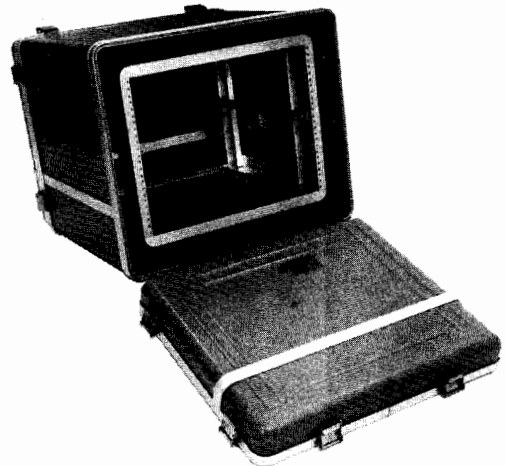

Elastomeric shock mounted frames provide outstanding shock and vibration attenuation. A set of standard shock mounts can be provided for any equipment weight and fragility.

Accessories and Options

A number of accessories and options are available to provide maximum flexibility. Drawers are available in three heights so that small accessories, supplies, and tools can be kept inside the case with the instrument (cut foam cushions can be designed to accommodate any of these items). Aluminum skids, stacking feet, internal power receptacles, and many other items are available as options on special orders, or as accessories for customer installation when ordered separately.

How to Order

Operating cases, like transit cases, are ordered through your local HP sales office. Because of the wide variety of options available and the number of configurations possible, it is recommended that you discuss your needs with an HP representative before you order.

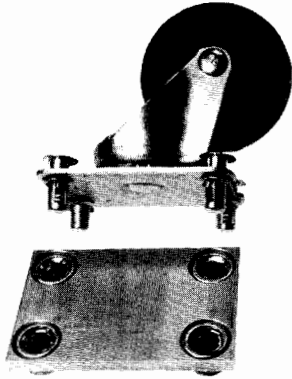

Heavy duty removable caster and mounting plate

Operating Case Selection Guide

Case Width = 24.00 in./609.6 mm (standard)

Case Depth = 28.50 in./723.9 mm (standard)

Nominal Rack Height in. ISO	Instrument Weight				Case Height		HP Part Number
	maximum lbs	minimum kg	maximum lbs	minimum kg	in.	mm	
5.25 3U	75	34.0	20	9.1	10.75	274.3	9211-1302
8.75 5U	75	34.0	20	9.1	15.20	381.0	9211-1303
10.50 6U	130	59.0	30	13.6	17.00	431.8	9211-2635
12.25 7U	130	59.0	30	13.6	18.87	480.1	9211-1163
14.00 8U	130	59.0	30	13.6	20.50	523.2	9211-1241
15.75 9U	130	59.0	30	13.6	22.25	569.0	9211-1242
17.50 10U	130	59.0	30	13.6	24.00	612.1	9211-1243
19.25 11U	130	59.0	30	13.6	25.75	657.9	9211-1244
21.00 12U	250	113.4	50	22.7	28.00	711.2	9211-1245
22.75 13U	250	113.4	50	22.7	29.75	749.3	9211-2636
24.50 14U	250	113.4	50	22.7	31.50	787.4	9211-1911
26.25 15U	250	113.4	50	22.7	33.25	782.3	9211-2637
28.00 16U	250	113.4	50	22.7	35.00	876.3	9211-2638
29.75 17U	250	113.4	50	22.7	36.75	924.6	9211-2639
31.50 18U	250	113.4	50	22.7	38.50	965.2	9211-2640
33.25 19U	250	113.4	50	22.7	40.25	995.7	9211-1713
47.25 27U	320	145.2	70	31.8	53.88	1369.1	9211-2641

Standard Features

Inner rack frame with provision for infinitely adjustable T-bar instrument support bracket. Standard 20" depth.

Inner rack frame with RETMA hole pattern drilled in rear rails.

Standard color: pearl grey cabinet.

Manual pressure relief valve.

Special Features Available

A. Mating feet for stacking one case on top of another.

B. Special color. Please specify.

C. Modified inner rack frame depth. Standard depth 20" from front panel mounting surface to rear surface of frame. This option includes an appropriate change in the overall depth of the enclosure. Please specify desired inner frame depth. Maximum 23", minimum 12".

D. Chassis trak C-300 instrument slide pair to mount on either side of inner frame using RETMA hole pattern drilled in front and rear rails.

E. Special shock mounts for unusual instrument weights. Please specify weights.

F. Increased front cover depth. Maximum depth 6". Please specify.

G. Increased rear cover depth. Maximum depth 6". Please specify.

H. Latches recessed into the surface of the case.

I. Handles recessed into the surface of the case.

J. Hermetically sealed case tested by the hot water method.

K. MIL-C-4150 certification with the exception of design and preproduction testing. Case will have increased wall thickness, hardware anodized to military specification, and will be hermetically tested using the hot water method.

L. Automatic pressure relief valve.

M. Addition of four permanently mounted, 3½" diameter swivel casters.

N. Addition of four removable, 3½" diameter swivel casters. Also available in kit form.

O. Addition of two aluminum hat-section skids to the case bottom.

P. Addition of lift rings to either side of the case.

Q. 3½ H (88.1 mm) Drawer with ball bearing slides.

R. 5¼ H (132.6 mm) Drawer with ball bearing slides.

S. 7 H (177 mm) Drawer with ball bearing slides.

T. Pair T-Bar instrument support brackets.

U. AC power receptacle strip with four outlets mounted on bottom rear of inner rack frame. Power cord 1 meter (3' 3") long. NEMA connectors.

Accessories (when ordered separately)

9211-1164 3½ H (88.1 mm) Drawer with ball bearing slides.

9211-1165 5¼ H (132.6 mm) Drawer with ball bearing slides.

9211-1166 7 H (177 mm) Drawer with ball bearing slides.

0950-0122 AC power receptacle strip with four outlets mounted on bottom rear of inner rack frame. Power cord 1 m (3.3') long, NEMA connectors.

9211-1173 Pair T-Bar instrument support brackets.

1490-0913 Caster kit, four removable 3½" (88.9 mm) swivel casters. For transit cases only.

5081-5832 Aluminum hat section skids (2) for case bottom

5081-5834 Caster kit, four removable 3½" (88.9 mm) swivel casters. Heavy duty for Operating Cases only.

On special order, complete transportable field instrument groups can be assembled to suit individual requirements. On request, cases can be fabricated that meet the environmental requirements of Military Specifications.

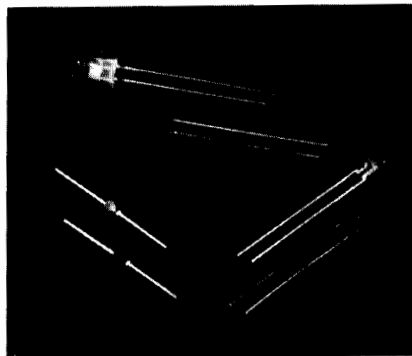

Snap-In Fiber Optic Link

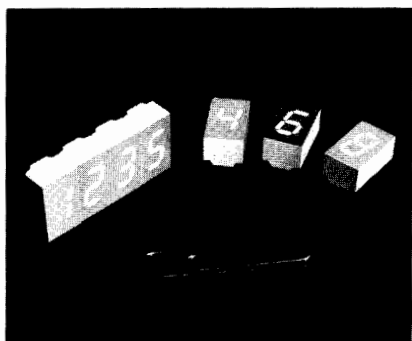

Seven-Segment LED Displays

LED Solid State Lamps, Light Bars & Arrays

Hewlett-Packard is a world leader in the area of LED technology, and offers a broad variety of LED indicator products available in red, yellow and green. Emphasizing high brightness and superior reliability, Hewlett-Packard's most recent product introductions include a family of high-performance green indicators, ultrabright LED lamps (125 mcd at 20 mA), and LED bar graph arrays of 10- and 101-elements. Recent advancements in the fundamental semiconductor material have generated new areas of contribution, particularly in sunlight viewability, low power consumption, and brightness.

Solid State Displays

Hewlett-Packard offers a complete line of LED alphanumeric and seven-segment display products available in red, yellow, and green. These displays are suited to meet the needs of high ambient light conditions, military systems, instruments, point of sale equipment, appliances, and automobile instrumentation. Their high-reliability and ruggedness qualifies them for use in applications with stringent environmental requirements.

Optocouplers

Hewlett-Packard's family of logic compatible, high-performance optocouplers provides solutions to problems caused by ground loops and induced common mode noise for both analog and digital applications in commercial, industrial and military products.

Types of optocouplers available include high-speed and high-gain devices, AC/DC to logic interface optocouplers, and optocouplers which interface directly with microprocessors.



39301A Fiber Optic Multiplexer

Fiber Optic Components

Hewlett-Packard offers a wide range of high-reliability transmitter/receiver components, cable, connectors and connector assembly tools, as well as two families of low cost components for high-volume OEM design. Link design and guaranteed specifications take device variation into account, as well as effects of temperature and lifetime for trouble free system performance.

Typical applications include data acquisition and control, electronic data processing, and process monitoring and control.

Fiber Optic Data Communications Equipment

The newest member of HP's growing family of local data communications equipment is the 39301A Fiber Optic Multiplexer. The multiplexer system incorporates Hewlett-Packard's fiber optic device and cable technologies.

A pair of 39301A's enable up to 16 RS-232-C/V.24 channels to be extended up to 1 km over interconnecting fiber optic cables at 19.2 kbytes data rates. The advantages of this configuration are complete immunity to noise producing electromagnetic interference such as RFI, EMI and EMP.

Optical Shaft Encoders

Hewlett-Packard's high-reliability, yet easy-to-assemble optical encoders are motion sensors that provide a digital link between mechanical shaft rotation and the control electronics in a closed loop servo system. By combining precision lenses and custom IC's, Hewlett-Packard provides superior perfor-

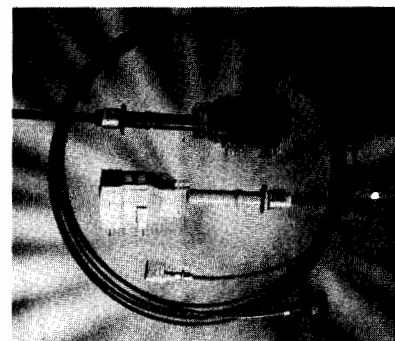

Low Current LED Lamps

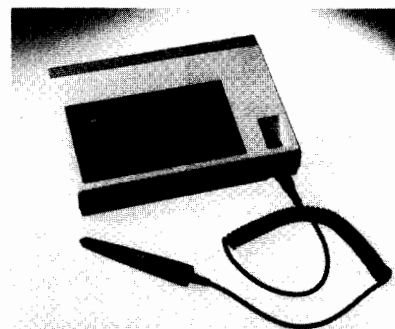

High-Resolution Bar Code Reader

mance and high reliability in two compact package sizes.

Encoders are used in a wide variety of applications from computer peripherals to industrial and instrument applications where digital information is needed to monitor rotary motion.

Bar Code Products

Bar code data entry is an effective alternative to the keyboard when used to collect information in self-contained blocks. Because most codes have check-sums built-in, bar code scanning is faster and more accurate.

HP's family of bar code products has expanded to include a Bar Code Reader available in both programmable models. When interfaced directly to a CPU, the Reader can be used as a stand-alone unit with LED indicators and beeper as operator feedback, or it can be used in conjunction with a CRT terminal.

All Hewlett-Packard bar code wands provide constant TTL level digital output, eliminating the need for the designer to provide an analog-to-digital interface with their equipment. A selection of wands is available to accommodate different bar code densities and industrial needs.

Emitter/Detector Components

In addition to the complete bar code system, Hewlett-Packard also offers the designer the choice of both integrated and discrete emitter/detector components, such as a high-resolution optical sensor, high radiant intensity emitters in the near infrared range, and PIN photodiodes.

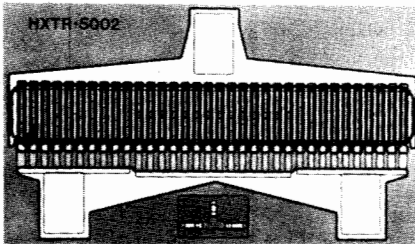
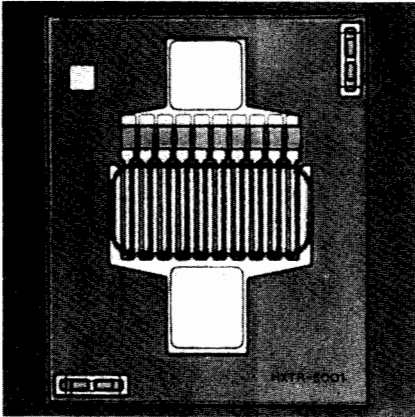

Silicon Bipolar Transistors

Device-to-device uniformity and superior performance are combined in the HXTR series of microwave transistors which have been individually designed for low noise (HXTR-6000 series), high gain (HXTR-2000 series), low distortion linear power (HXTR-5000 series), or low cost (HXTR-3000 series). With guaranteed RF performance specifications from 1000 to 4000 MHz, these devices are well suited for high-reliability, space military, and industrial applications at frequencies up to 6000 MHz.

Diodes

Schottky Barrier Diodes: Schottky diodes combine extremely high rectification efficiency with pico-second switching speeds, low series resistance, and low noise characteristics. This combination makes the Schottky an excellent mixer/detector diode.

At HF, VHF, and UHF frequencies, HP offers Schottky diodes in hybrid form as beam leads and chips, and in package styles suitable for microstrip, stripline, waveguide, and coaxial assemblies. These same diodes have many digital circuit applications such as clipping and clamping where switching speed is important. The most popular of the glass packaged diodes are available in JAN qualified types.

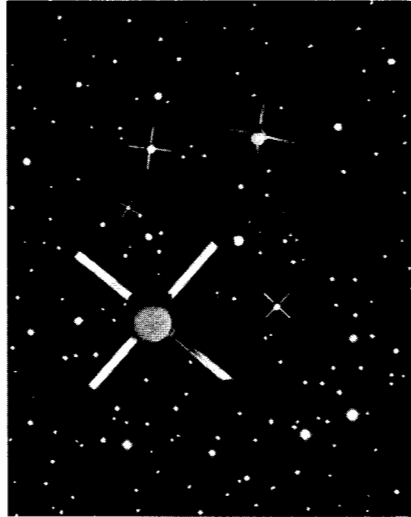

PIN diodes: PIN diodes function as variable resistors at microwave frequencies. By controlling the DC bias, the RF resistance of a PIN diode can be varied from 1Ω to about 10Ω . This property of the PIN diode makes it extremely useful as a switch, attenuator, modulator, phase shifter, limiter or AGC element at all frequencies from 1 MHz to 18 GHz and above. Package configurations include beam lead devices as well as conventional microstrip, ceramic and axial-leaded packages.

Step recovery diodes: SRD's are intended for use as comb generators and harmonic frequency multipliers. When used as a comb generator, the abrupt termination of the diode's reverse recovery current generates voltage pulses up to tens of volts with pulse widths as narrow as 100 ps giving useful power at frequencies in excess of 20 GHz. By optimizing the circuit around any specific harmonic, high efficiency multiplication can be accomplished.

Diodes for Hybrid Integrated Circuits: Hybrid Integrated Circuits are used to achieve circuits with light weight, small size, operation to high frequencies, repeatable characteristics and lower end product costs. HP offers a wide range of PIN, Schottky and SRD single diodes in beam lead, chip and LID configurations as well as Schottky beam lead quad diodes.

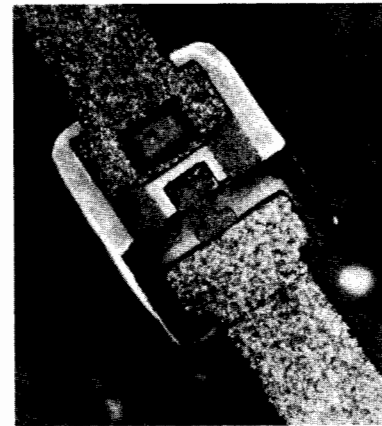
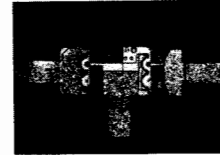

Integrated Products

Hewlett-Packard manufactures a broad line of components for the control, conversion, and generation of RF and microwave signals. This line of integrated products (combinations of chip and beam lead diodes with hybrid thin film circuit technology) includes SPST switches, absorptive modulators, attenuators, limiters, comb generators, double-balanced mixers, and mixer/detectors.

High Reliability Testing

Many Hewlett-Packard components are space qualified. The reliability of these devices is established by one of the finest high reliability testing facilities in the microwave component industry. Hewlett-Packard's High Reliability Test Group maintains military approved JAN and JANTX parts in stock and can recommend HP standard screening programs, patterned after MIL-S-19500, for any HP component. Those who wish to design their own screening specifications can consult with and obtain quotations from Hewlett-Packard's staff of dedicated field sales engineers.

Write for More Information

Specifications of Hewlett-Packard's component products are available in individual data sheets or complete designer catalogs. These are available free of charge from your local HP sales office or authorized distributor, or return the Information Request Card located at the back of this catalog.

ANALYTICAL INSTRUMENTS FOR CHEMISTRY

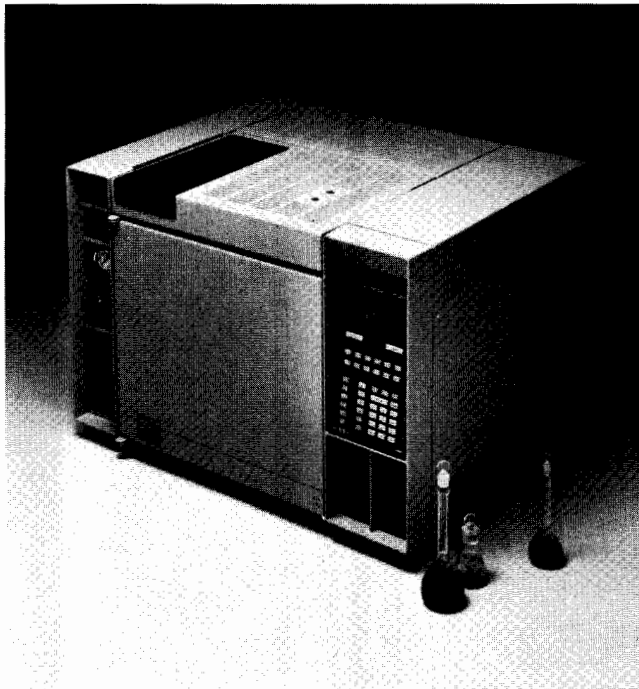

HP 5890A Gas Chromatograph

Gas Chromatographs. Choose a GC that offers the maximum in chromatographic and data handling capability such as the HP 5880; or the new HP 5890, or the HP 5790 GC's which offer superb value but are still optimized for high resolution chromatography. Also

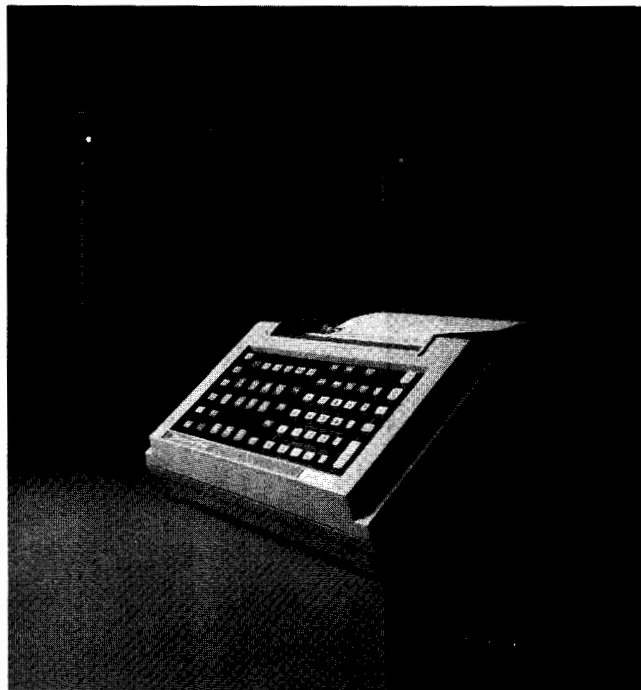

HP 5880A Gas Chromatograph

available is a wide range of accessories, including the new "mega-bore" columns, automatic samplers and detectors, including the powerful HP 5970 Mass Selective Detector, and a full line of consumables.

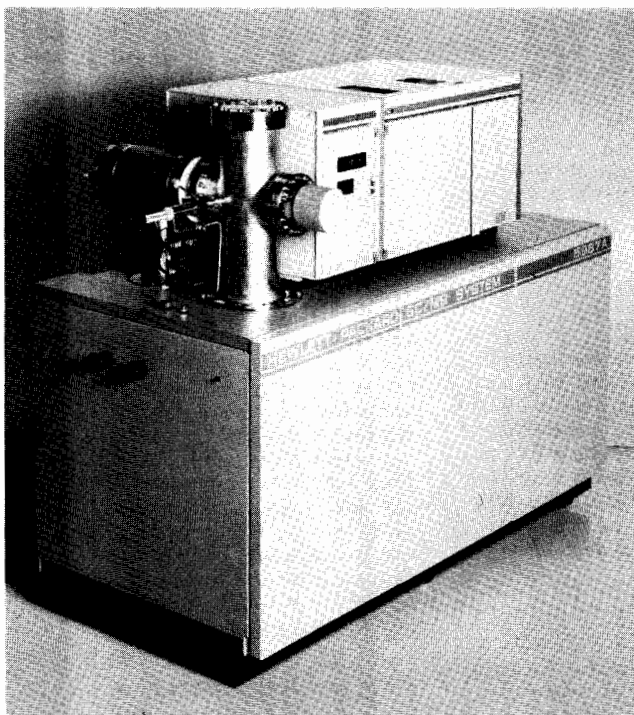

HP 5987A GC/Mass Spectrometer

Hewlett-Packard GC/MS Systems offer many advances such as hyperbolic quadrupole mass filters, which provide improved peak shapes and high sensitivity compared to round-rod filters. The GC/MS product line ranges from the research grade 5987A system

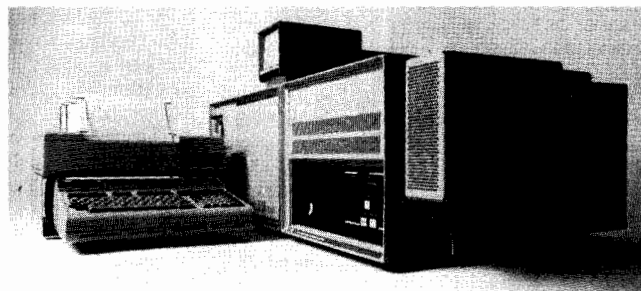

HP 5970 Mass Selective Detector

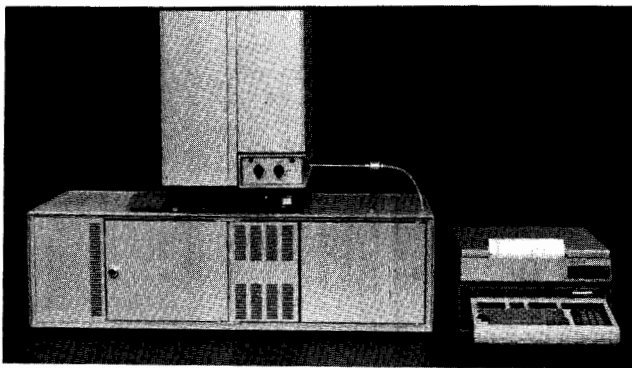

HP 5995B GC/Mass Spectrometer

with the powerful, multi-terminal RTE-6/VM data system—to the 5995B benchtop system which offers excellent performance at a much more economical price.

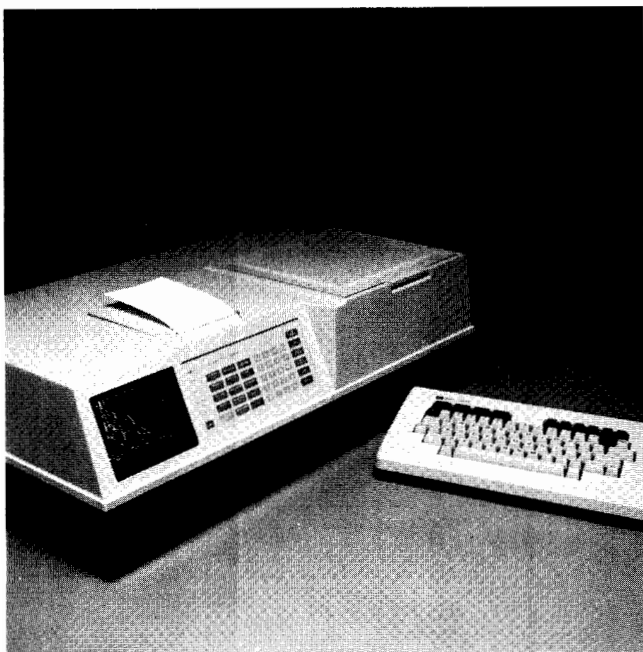

HP 8451A Diode Array Spectrophotometer

Diode Array Spectrophotometers. These powerful computer-controlled UV/VIS instruments utilize diode array technology to greatly speed complex analyses. They measure and display in *seconds*: multi-component analyses, a full spectrum, and lists of analysis conditions and concentration. Choose the more powerful HP 8450A, or the new HP 8451A with built-in printer/plotter and optional alphanumeric keyboard.



HP 1090 Liquid Chromatograph

Liquid Chromatographs. The HP 1090 LC is the first of a growing family of integrated modules. It offers maximum serviceability and upgradeability whether you are using conventional, high-speed, or microbore columns. Also available is a full line of LC columns and accessories including detectors, data handling devices, automatic samplers, injectors, solvent delivery systems and consumables.

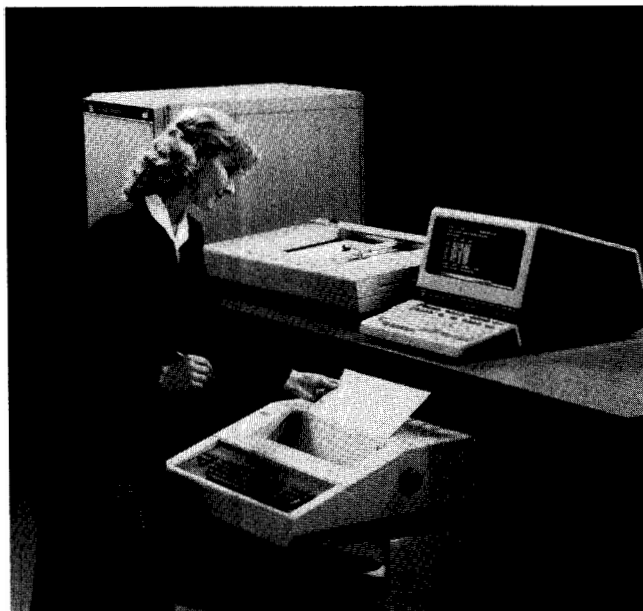

HP 3357 Lab Automation System

Laboratory Automation Systems. Whatever size your laboratory, HP laboratory automation systems and integrators can help you increase productivity. HP 3350 Series Laboratory Automation Systems can increase sample throughput by automating your lab's analytical procedures, providing easy to use, yet sophisticated data reduction, and performing record keeping tasks. The HP 3390 series Integrators offer labs the first step in integrating, automating and networking.

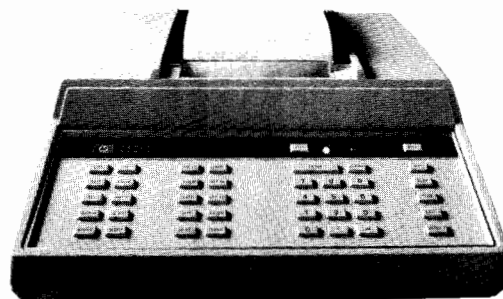

HP 1040A Spectrophotometric Detector

For further information on Hewlett-Packard instruments and computers for chemical analysis, call your local HP office listed in the white pages of your metropolitan telephone directory and ask for an analytical representative. Or write: Hewlett-Packard Analytical Group, 1820 Embarcadero Road, Palo Alto, CA 94303.



Ultrasound Imaging

- Real-time phased array systems
- New 77020AC System configured specifically for the cardiologist—totally mobile—VCR and strip chart
- New 77020AR System configured specifically for economical abdominal, obstetrical and pelvic imaging
- Small lightweight transducers

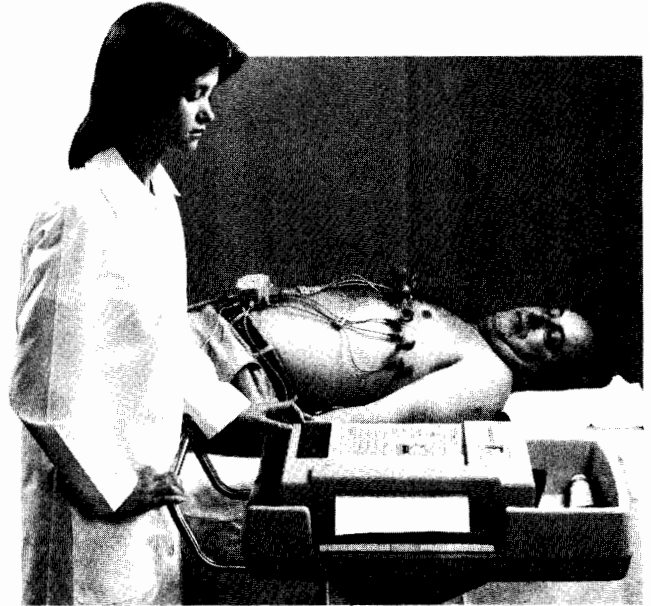

Cardiography Instrumentation

- New 4750A PageWriter Cardiograph
- ECG Management Systems for computer-aided interpretation of electrocardiograms
- ECG Stress Testing Systems

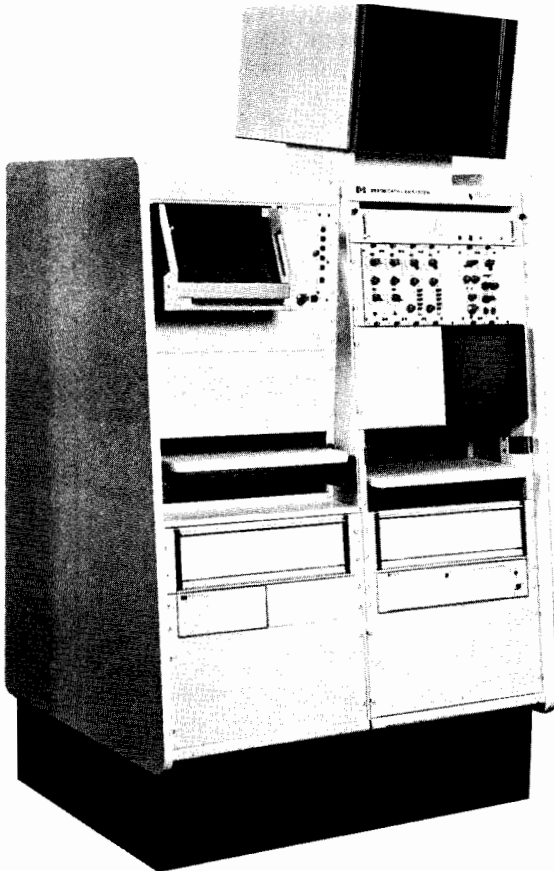

Cardiovascular Instrumentation

- Computerized catheterization data analysis system automates on-line data collection analysis
- Complete choice of plug-in signal conditioners and transducers



Perinatal Instrumentation

- Fetal/maternal monitoring equipment includes new 8040A Bed-side Fetal Monitor, and central stations
- Telemetry for birthing centers
- Neonatal monitoring includes heart rate, temperature, respiration, ambient oxygen

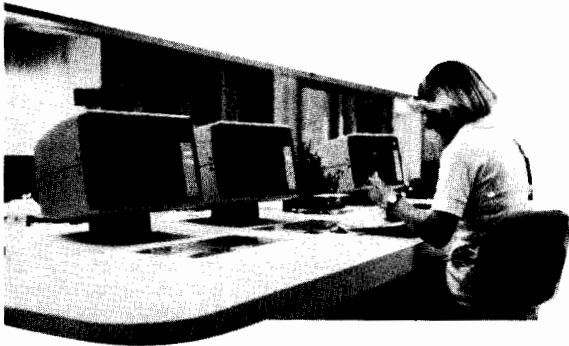

Arrhythmia Monitoring

- Detection and classification by algorithm
- Advanced information management capabilities



Resuscitation

- Portable defibrillator/monitor with paddle contact indicator
- Battery/AC operating
- Digital heart rate display
- Mobile resuscitation systems

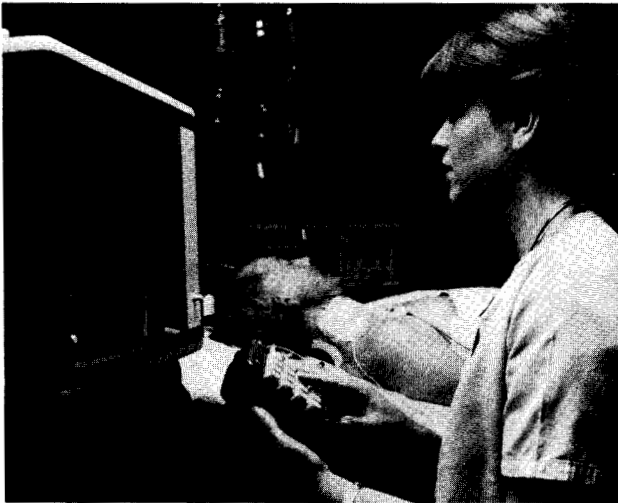

Patient Data Management

- Rapid access to progress notes, vital signs, intake/output, lab data and trends
- Organization and calculating data

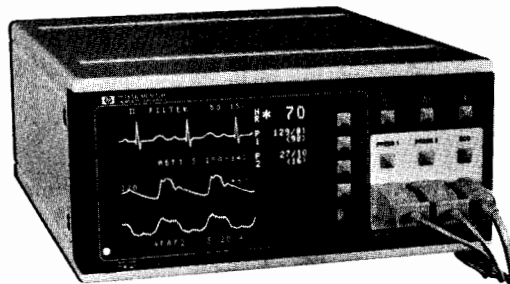

OR Monitoring

- New microprocessor based ECG monitor designed for the OR
- Software cardiotech improves ECG signal detection, provides multilevel alarm capability

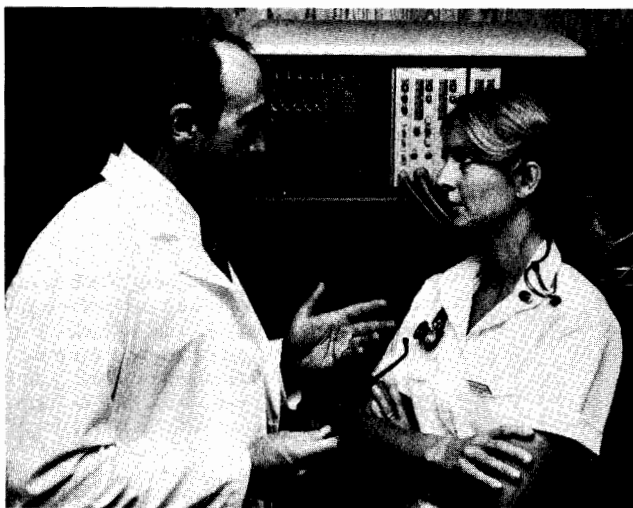

Patient Monitoring

- Monitor/Terminal with "Overview" feature
- Patient Information Centers
- Telemetry

For Additional Information on HP Medical instrumentation, request literature in one or more of the following categories:

- Patient Monitoring
- Ultrasound Imaging
- Cardiography Instrumentation
- Cardiovascular Instrumentation
- Perinatal Instrumentation
- Arrhythmia Monitoring
- Patient Data Management
- OR Monitoring
- Resuscitation

Please use request card at back of catalog.

An Invitation for you to become a subscriber to **ADVANCES FOR MEDICINE**, the Hewlett-Packard medical products magazine. To receive **ADVANCES** free of charge, simply fill in and return the request card at the back of this catalog.

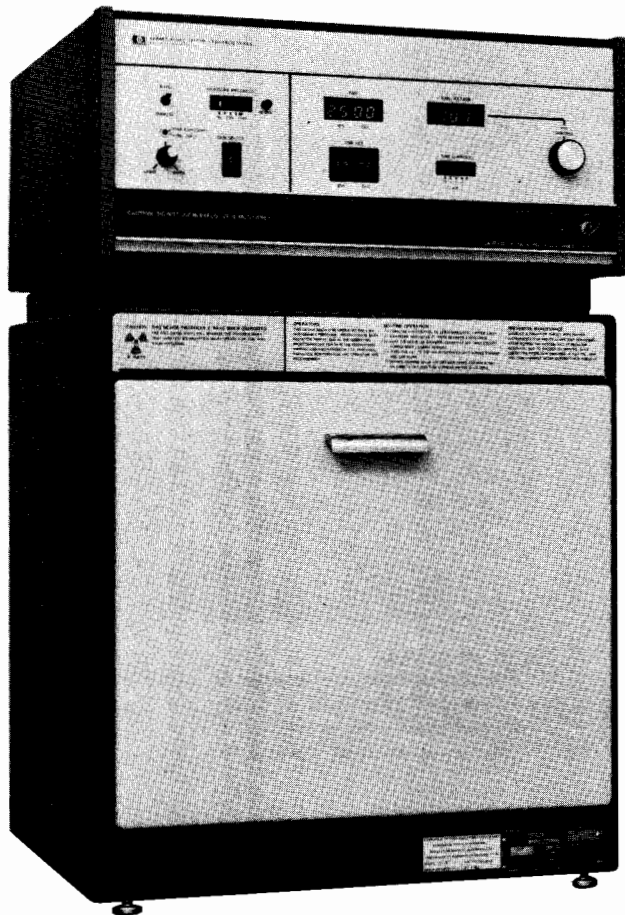

Faxitron® Cabinet Systems

Radiography, the art and science of making pictures with X-rays, has an important place in modern technology. It is one of the major nondestructive test methods available to industry, provides an indispensable tool in scientific investigations and is a valuable aid to law enforcement agencies. Hewlett-Packard makes a major contribution to these activities with X-ray equipment that offers a "better way" through advanced technology and design. This equipment makes radiographs easier and safer to take.

Industrial Inspection

Industrial quality control and inspection procedures, especially in the field of electronics, benefit from nondestructive testing by radiography. The advantages of a testing method which does not harm the test objects are obvious. Radiography, therefore, offers benefits in design engineering, incoming inspection, production quality control, product reliability and failure analysis. X-rays are used to detect misregistration or plate-thru problems in multi-layer P.C. boards; porosity, poor substrate bonding and wiring or lead location in transistors and integrated circuits; voids and other encapsulation problems in potted

components; and solder balls or other defects in sealed relays.

Die casting is another industry that benefits from the nondestructive aspects and ability to "see inside" provided by radiography. Porosity, gas voids, tramp metal inclusion and other common defects can be easily detected and the cause determined. Expensive machining time can be avoided for castings found to be defective through X-ray inspection. The integrity of welds, alignment of connectors, inspection for proper assembly and mechanical defects are further examples of tests which radiography performs for industry. The benefits of X-ray testing are reduced production costs, better quality assurance and product safety. The results are increased profits.

Medical Applications

HP Faxitron Cabinet X-ray Systems are used by the medical profession for specimen radiography in support of diagnostic surgical procedures and in biological research. Specimen radiographs of biopsy samples are correlated with preoperative mammograms, for example, and in the evaluation of mastectomy specimens. Typical research applications include microradiography of thin bone specimens and microangiographic studies of vasculature.

Scientific Applications

Oceanography, geology, marine biology, paleontology, pathology, botany, forestry and agricultural research are a few examples of scientific disciplines that use X-rays. Applications range from the study of the interior anatomy of fossils to determining the viability of seeds.

These are among the many applications served by HP Faxitron® Cabinet X-ray Systems. They offer a unique combination of high quality radiographic capability, simplicity of operation and convenience of use which is expanding the capabilities of scientific and industrial concerns throughout the world.

43700 Series Flash X-Ray Systems

High-speed (flash) radiography is used to record and study dynamic events where interposed material, smoke, flame, debris, or pressure variations exclude the use of high-speed cameras. Typical events include ballistics, shaped charges, explosives, behind-armor studies, shock waves in solids, aerospace phenomena, and crash-injury studies.

The basic performance requirement of a flash X-ray system used for the study of transient mechanisms is to provide high resolution radiographs with exposure times short enough to eliminate motion blur. HP Series 43700 flash X-ray systems produce X-ray pulses of sub-microsecond duration and are designed specifically for "stop motion" radiographic applications. All Model 43700 Series systems utilize the same basic components, the same electrical theory, and are modular in concept. Standard systems include 150 kV, 300 kV, 450 kV, 1 MV, and 2.3 MV models.

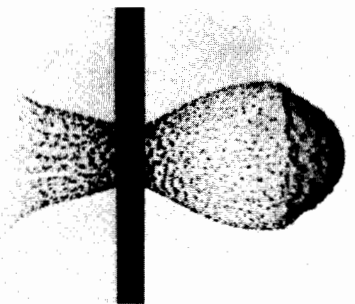

An HP basic single "channel" flash X-ray system, composed of a pulse generator, high-voltage power supply, cold-cathode field emission X-ray tube, and associated controls, provides a single radiograph per event. Additional pulser/X-ray tube sets (add-on channels) may be combined with the initial single-channel system to provide multiple-channel "systems." Multiple channel systems may be of identical output voltage or may use varied output voltage pulser/tube combinations.

For specific information and consultation regarding HP X-ray systems, contact Hewlett-Packard, 1700 S. Baker Street, McMinnville, Oregon 97128, telephone: (503) 472-5101.



No-Charge Aids to Selecting, Using & Maintaining HP Products



HP offers a variety of no-charge publications to help you choose the HP products that best fill your needs, to help you benefit from applications knowledge acquired by users inside and outside of HP, and to help you maintain your HP products. These publications range from new-product announcements, catalogs, product family brochures, and single-product technical data through application notes, product notes, and programming aids to service notes and general maintenance periodicals. Since the number and types of publications vary with product type, an outline of available publications organized by product type is provided below for your convenience.

Instruments and Systems

Product Information

Measurement/Computation News

Data Sheets and Brochures

Catalogs

DC Power Supplies

Recorder Supplies

Coaxial & Waveguide Measurement

Accessories

Digital IC Tester Program

HP Journal

Application Information

Application Notes

Product Notes

Programming Notes

Service Information

Service Notes

Bench Briefs

Computers, Peripherals &

Calculators

Product Information

Computer Advances

Measurement/Computation News

Data Sheets & Brochures

Catalogs

Computer Supplies Catalog

HP Journal

Application Information

Application Notes

Application Briefs

Medical

Product Information

Advances for Medicine

Data Sheets & Brochures

HP Journal

Application Information

Application Notes

Analytical

Product Information

Data Sheets & Brochures

HP Journal

Application Information

Application Notes

Components

Product Information

Catalogs

Diode and Transistor Designer's Catalog

Optoelectronics Designer's Catalog

Microwave Integrated Products

Data Sheets

HP Journal

Application Information

Application Notes

Application Bulletins

Measurement/Computation News

Six times a year M/C News brings you announcements of HP's latest electronic measuring instruments and their accessories; personal, desktop, and larger computers, their software, peripherals, and accessories; optoelectronic and semiconductor components; and new no-charge literature such as catalogs and application notes.

Computer Advances

Published bimonthly for owners and users of HP computer products, Computer Advances keeps you up-to-date on the latest computer products and services.

Advances for Medicine

Advances for Medicine is a quarterly magazine that presents timely articles on measuring physiological parameters in unique or improved ways; on saving time, labor, and equipment costs; and on using data processing for efficient hospital management.

Application Briefs, Bulletins, and Notes

These aids to solving your measurement, computation, and design problems offer the benefit of the applications research and experience of both HP customers and HP engineers. Some are tutorial, others describe how-to procedures.

Product Notes

Product Notes augment the Operating and Service Manuals supplied with HP electronic instruments by providing information on various topics that include specifications and characteristics, operation and use, applications and performance.

Programming Notes

Programming Notes provide product-specific information on the use and operation of instruments in HP-IB systems. Some notes address the needs of inexperienced users and cover basic operation of an HP-IB instrument using a specific HP desktop computer. Others address the needs of experienced users.

Service Notes

Service Notes contain product-specific servicing information for HP's electronic instruments. Subjects include improvement modifications and procedures for troubleshooting, maintenance, and repair. Service Notes are published as appropriate throughout the life of a product, and new Notes are announced in Bench Briefs.

Bench Briefs

Bench Briefs provides those who maintain HP instruments with timely information that has both specific and general application. Subjects include troubleshooting tips and descriptions of new technologies, components, tools, and equipment. Also, new Service Notes are listed in Bench Briefs as they become available.

Hewlett-Packard Journal

Published monthly to communicate technical information from the laboratories of HP to all of the fields served by HP, the Journal contains descriptions of current hardware and software products as well as more general information such as advances in technology.

How to Obtain No-charge Publications

To obtain any of the publications described on this page, contact your nearest Hewlett-Packard office. Locations of HP offices are listed on the back pages of this catalog.

HP offices are also your best source of current information on the topics covered by Application Briefs, Application Bulletins, Application Notes, Product Notes, and Programming Notes.



POST-SALE SUPPORT SERVICE

Instrument Support Hardware Support Services

- A Service plan for every need
- Personalized service
- HP engineered quality

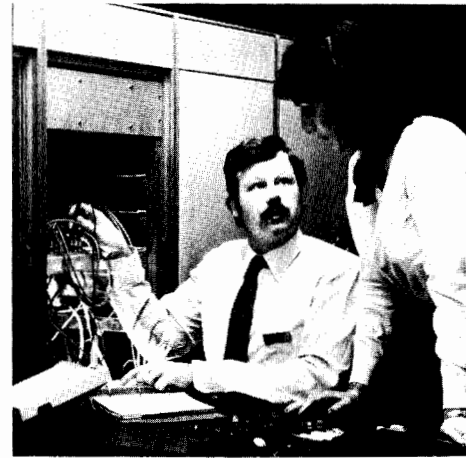
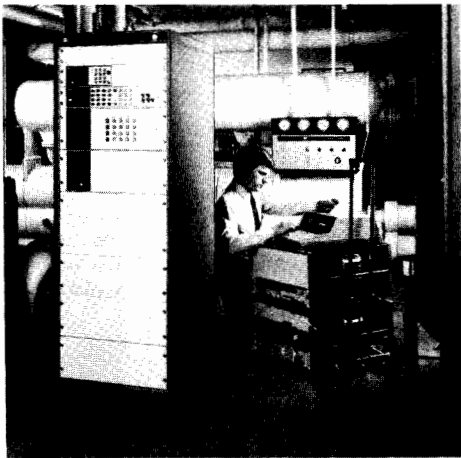

Hardware Support For Your Productivity

You will gain a powerful tool when you invest in the engineering excellence of HP instruments and systems. Yet simply choosing productive HP hardware is often not enough to maintaining your increased productivity. High performance equipment demands high performance maintenance in order to sustain your productivity. At HP we recognize this, and we have used our more than 40 years of engineering experience to design hardware support services that match the quality and performance of our instruments.

A Spectrum of Hardware Support Services

At HP we understand that our customers have different maintenance requirements, from occasional repair to cal lab backup. That's why we've designed a complete spectrum of support products for you.

If you want cost-effective Maintenance Agreements that offer insurance-like protection, or per-incident service at low standardized prices — we have a plan for you. If you need on-site service for your systems, or fast return to HP service for your components — we have a plan for you. If you need instrument repair only or just calibration backup for your cal lab, or both — we have a plan for you.

Maintenance Agreements for HP Managed Support

In most instances HP Maintenance Agreements offer you the best value for your maintenance dollar. The price of an Agreement can represent important savings since all repairs are covered, even when expensive to repair microcircuits are involved.

Repair Agreements provide all the labor and parts needed to correct malfunctions whenever required during the term of the agreement. The only exceptions are abuse, misuse or accidental damage.

Calibration Agreements provide performance testing and adjustment of properly operating instruments to original instrument specifications at factory prescribed intervals.

Full Service Agreements combine the benefits of repair and calibration services at a cost savings compared to purchasing the services separately.

Agreements allow you to reduce downtime by eliminating quotation and approval, and priority status is given to Agreement covered instruments. Agreements also save you the risk of having to finance unusually costly repairs, and the fixed yearly charge gives you a known, budgetable service cost.

Keeping Your System Up and Running

HP's system level Maintenance Agreements offer a number of practical advantages that keep your system's productivity high.

When you purchase a Basic System Maintenance Agreement an experienced HP Customer Engineer is assigned to your account with the responsibility of managing a maintenance program specifically designed for your system. Services include: site environment surveys to ensure your instruments operate under proper conditions; preventative maintenance to identify and correct potential problems before they occur; remedial maintenance to correct malfunctions; and engineering improvements to extend the useful life of your system.

Other features include same day, or faster, response on service requests placed during normal working hours at sites within 100 miles (160 km) of a support office, and work to completion once the Customer Engineer arrives. All necessary parts and labor are included, a loaner option is included, and when purchased at the same time as your hardware, warranty terms are extended to match agreement terms at no extra cost.

Keeping Your Instruments Up and Running

An HP Maintenance Agreement can also make sense for you if you have individual instruments or system components that can be returned to HP. When you purchase an Instrument Repair Center Agreement you receive many of the same benefits described under our System Agreements.

Agreements are available to provide repair service, calibration service or both on return to HP bench. When your instrument arrives at one of our conveniently located Instrument Repair Centers around the world, it is given priority response and attended to by a skilled bench technician. All labor and parts required to perform the services are included.

Per-Incident Services for Support When You Want It

If your maintenance needs are more limited, or if you prefer to manage your own maintenance program, HP Instrument Repair Center per-incident services offer you cost-effective maintenance.

For some 700 current instruments, standard repair and calibration prices have been established. These standard prices cover routine repair and calibration of HP instruments which break down in normal use. Even though our maintenance effort may vary from incident to incident, the work quality and prices remain standard.

Reduce Downtime = Increase Productivity

Whether you prefer Agreements or Per-Incident services, you receive the same level of commitment to high quality. When you use HP support services you automatically plug into our worldwide network of service experts dedicated to supporting your success, no matter where in the world you need it. Their knowledge, backed up by HP factory engineers, can give you the confidence that you are doing all you can to reduce your downtime and increase your productivity.

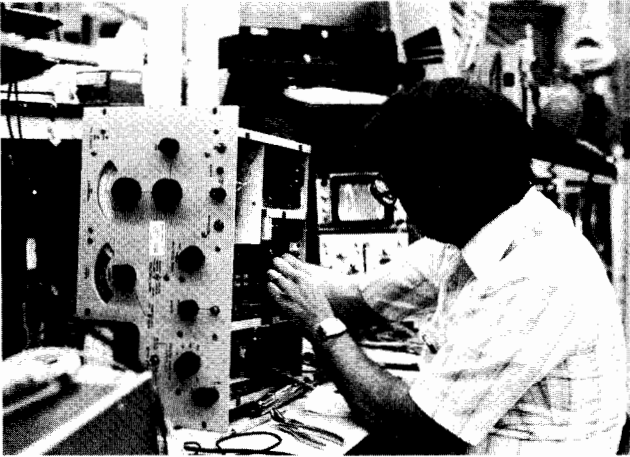

Service Publications—Help You Maintain Your Instruments

The *Operating and Service Manual* supplied with Hewlett-Packard instrumentation contains maintenance, calibration, diagnostic and repair procedures, with troubleshooting charts circuit diagrams, and replacement parts lists. Most operating and service manuals, manual updates, and Service Notes are now available on COSATI standard, positive microfiche.

Bench Briefs, a periodic newsletter, has information to help repair and maintenance personnel get maximum performance from Hewlett-Packard instruments. It describes new Service Notes and other company publications as they become available. To become a regular subscriber, ask your local HP office to place your name on the mailing list.

Warranty—Confidence in Quality and Reliability

As an expression of confidence that our products will continue to meet the high standards of reliability and performance that our customers expect, Hewlett-Packard products carry the following warranty:

HP hardware products are warranted against defects in materials and workmanship. If HP receives notice of such defects during the warranty period, HP shall, at its option, either repair or replace hardware products which prove to be defective.

HP software and firmware products which are designated by HP for use with a hardware product, when properly installed on that hardware product, are warranted not to fail to execute their programming instructions due to defects in materials and workmanship. If HP receives notice of such defects during the warranty period, HP shall repair or replace software media and firmware which do not execute their programming instructions due to such defects. HP does not warrant that the operation of the software, firmware or hardware shall be uninterrupted or error free.

If HP is unable, within a reasonable time, to repair or replace any product to a condition as warranted, Buyer shall be entitled to a refund of the purchase price upon return of the product to HP.

a. SUPPLEMENTAL STATEMENT: Supplemental statements setting forth the duration and implementation of warranty and installation are available for most product types. These statements, if applicable to purchased products, are attached hereto and incorporated herein.

b. DURATION AND COMMENCEMENT OF WARRANTY PERIOD: The warranty period for each product is specified in the supplemental statement of warranty and installation attached hereto

and incorporated herein. The warranty period begins either on the date of shipment or, where the purchase price includes installation by HP, on the date of installation. If Buyer schedules or delays installation more than thirty (30) days after delivery, the warranty period begins on the thirty first (31st) day from the date of shipment.

c. PLACE OF PERFORMANCE: Within HP service travel areas, warranty and installation services for products installed by HP and certain other products designated by HP will be performed at Buyer's facility at no charge. Outside HP's service travel areas, warranty and installation services will be performed at Buyer's facility only upon HP's prior agreement and Buyer shall pay HP's round trip travel expenses and applicable additional expenses for such services.

On-site warranty services are provided only at the initial installation point. If products eligible for on-site warranty and installation services are moved from the initial installation point, the warranty will remain in effect only if Buyer purchases additional inspection or installation services at the new site.

Installation and on-site warranty services are available outside the country of initial purchase only if Buyer pays HP international prices. If Buyer transports a product from the country of initial purchase without having paid HP international prices, any remaining warranty covers parts and labor only and applies only if the product is returned to HP. However, Buyer may obtain on-site warranty service if the location is one where HP can normally provide on-site service for the product and the Buyer pays HP established travel charges. Service outside the country of initial purchase is subject to the conditions regarding HP service travel areas and initial installation point described above.

For product warranties requiring return to HP, products must be returned to a service facility designated by HP. Warranties requiring return to HP are not limited to the country of purchase. Buyer shall prepay shipping charges (and shall pay all duties and taxes) for products returned to HP for warranty service. Except for products returned to Buyer from another country, HP shall pay for return of products to Buyer.

d. LIMITATION OF WARRANTY: The foregoing warranty shall not apply to defects resulting from:

- 1. Improper or inadequate maintenance by Buyer;*
- 2. Buyer supplied software or interfacing;*
- 3. Unauthorized modification or misuse;*
- 4. Operation outside of the environmental specifications of the product; or*
- 5. Improper site preparation and maintenance.*

THE WARRANTY SET FORTH ABOVE IS EXCLUSIVE AND NO OTHER WARRANTY, WHETHER WRITTEN OR ORAL, IS EXPRESSED OR IMPLIED. HP SPECIFICALLY DISCLAIMS THE IMPLIED WARRANTIES OF MERCHANTABILITY AND FITNESS FOR A PARTICULAR PURPOSE.

EXCLUSIVE REMEDIES

The remedies provided herein are Buyer's sole and exclusive remedies. In no event shall HP be liable for direct, indirect, special, incidental or consequential damages (including loss of profits) whether based on contract, tort, or any other legal theory.

Certification—Traceability of Measurements to Known Standards

Products provided by Hewlett-Packard are thoroughly tested and calibrated to meet their published specifications. A Certificate of Conformance (certifying that the product meets its published specifications and that its calibration is traceable to appropriate National Standards) is available upon request at the time of purchase.

Hewlett-Packard's calibration measurements are traceable to National Standards—the National Bureau of Standards in the United States and to Standards authorities of comparable standing in other countries of manufacture.



ORDERING INFORMATION

Shipping, Prices, and Terms of Sale



Communicating With HP

Hewlett-Packard is committed to providing convenient local support and the best possible attention to customer needs on a worldwide basis. There are more than 172 sales offices and representatives, many of which provide service, located in 65 countries; a listing of these offices commences on page 681.

Your entry point to the resources of Hewlett-Packard is through the local HP office nearest you. Our sales representatives and order support specialists there are well-equipped to provide you with pre-sale assistance in product selection, as well as related business information such as current product availability and price delivered to your location.

Many HP sales offices are tied into a sophisticated intra-company communications system. This not only means prompt transmission of orders to any HP product responsible division—it also speeds the flow of regular messages among HP sales offices and factories. The objective, of course, is to provide the fastest possible response to your product interests.

Placing Your Order

Hewlett-Packard people at the sales office nearest you will be pleased to provide assistance in selecting the HP equipment most appropriate to your needs, and to help you prepare your order.

The information in this catalog will, in many cases, be sufficient for you to decide to buy a particular HP product. In those instances, a telephone call to the nearest HP office will provide you with (1) information

on product availability, and (2) the product's price.

HP wants to be sure the product delivered to you is exactly the one you want. Therefore, when placing your order, please specify the product's catalog (model, accessory, or part) number, as well as the product's name. Be as complete as possible in specifying exactly what you'd like, including standard options.

In the event you want special features or capabilities such as different color or a non-standard power line voltage, ask your HP sales representative about availability and cost of these "specials" first—and then, to prevent misunderstandings, include special instructions and specification details with your order.

Shipping Methods

Inside the USA: shipments to destinations in the USA are made directly from factories or local warehouses. Unless specifically requested otherwise, express or truck transportation is used, whichever is less expensive and most serviceable to you. Small items are sent parcel post or UPS. If fast delivery is needed, we gladly ship by air freight, air express, or air parcel post, when specified on your order, at prevailing rates. In many parts of the USA, a consolidated air freight service provides the speed of air transport at surface rates. Ask your HP sales representative for details.

Outside the USA: shipments to destinations outside the USA are made from the appropriate Hewlett-Packard facility by either surface or air, as requested. Sea shipments usually require commercial export packaging at a nominal extra charge.

Budgetary Prices

Price information which may be supplied with this catalog provides you with helpful budgetary guidance.

Please call your nearby Hewlett-Packard sales office to determine a product's delivered price.

Prices furnished with this catalog are net prices prevailing at the time of printing. Hewlett-Packard reserves the right to change prices, and those prices prevailing at the time an order is received will apply.

Quotations and Pro Forma Invoices

Destination prices and other details you may need to know before ordering can be quickly obtained via telephone. Just call your nearest HP office.

If you are an international customer requiring formal paperwork such as pro forma invoices or quotations, please contact the Hewlett-Packard office or representative serving your area. Exportation or importation assistance is also available.

Terms of Sale

Inside the USA: Hewlett-Packard's standard credit terms for established customers in the USA are net 30 days from invoice date.

Leasing and extended financial terms are available. However, the associated costs are not included in any product prices furnished with this catalog. Your nearby HP office will be pleased to discuss your requirements and work with you in setting up an appropriate program.

Outside the USA: terms for orders placed on Hewlett-Packard Company by customers outside the USA are irrevocable letters of credit or cash in advance—unless other terms have been previously arranged. Please contact authorized Hewlett-Packard international subsidiaries or distributors regarding terms for orders placed with them.

U.S. Government Sales

Some products in this catalog are covered on GSA federal supply schedule multi-award contracts.

Product Changes

Although product information and illustrations in this catalog were current at the time it was approved for printing, Hewlett-Packard, in a continuing effort to offer excellent products at a fair value, reserves the right to change specifications, designs, and models without notice.